

NEW GENERATION E.C. FANS



MOTORES
BRUSHLESS
INDUSTRIALES E.C.



MOTORES
DE ALTA
EFICIENCIA IE3

EFFICIENT WORK FANS



EFFICIENT
WORK





NUESTRO COMPROMISO CON EL MEDIO AMBIENTE

Sodeca ha iniciado una nueva etapa de estudio y diseño de nuevas tendencias de ventilación que ayuden a la preservación del medio ambiente y al ahorro energético que tanto preocupa a la sociedad actual.



EFFICIENT WORK

SODECA presenta los nuevos ventiladores eficientes **"Efficient Work"** de alto rendimiento, equipados con motorizaciones de alta tecnología para lograr un ahorro energético superior. Estos nuevos productos sobrepasan los requisitos de la directiva Ecodesing ErP 2009/125/CE y su reglamentación (EU) 327/2011 para ventiladores, colaborando con el objetivo KIOTO adoptado por la UE para la reducción de emisiones de CO².

SODECA centra su actividad en la producción de ventiladores industriales, sistemas de ventilación y extractores para la evacuación de humos en caso de incendio, desde 1983 año de su fundación.

Los ventiladores y extractores de **SODECA** están presentes en todos los países Europeos y en gran parte del mundo, gracias a la calidad del producto y a los métodos de investigación y desarrollo utilizados.

Nuestros procedimientos de calidad utilizados y certificados por BUREAU VERITAS, según ISO 9001:2008, son otra de las razones que sitúan a **SODECA** como uno de los mejores y más reconocidos fabricantes de ventiladores de Europa.

Sin duda el factor más importante para alcanzar nuestros objetivos, es el factor humano, grandes profesionales que trabajan a su servicio, ofreciendo no solo equipos de ventilación, sino soluciones a cualquier necesidad de ventilación planteada por nuestros clientes.

Les ofrecemos con toda sinceridad, la posibilidad de visitar nuestras instalaciones en Sant Quirze de Besora, con más de 16.000 m² de superficie construida, donde podrá ver con toda claridad nuestra fabricación de ventiladores, con las más altas exigencias de calidad, cumpliendo con las normativas de ISO y AMCA.

Este catálogo es solo un pequeño detalle de nuestras posibilidades, no dude en contactar con nosotros, ponemos toda nuestra experiencia y nuestro equipo humano a su disposición.



Instalaciones centrales de SODECA s.a., en Sant Quirze de Besora y planta de fabricación en Santiago de Chile.



SODECA presenta los nuevos ventiladores eficientes “**Efficient Work**” de alto rendimiento, equipados con motorizaciones de alta tecnología para lograr un ahorro energético superior. Estos nuevos productos sobrepasan los requisitos de la directiva Ecodesing ErP 2009/125/CE y su reglamentación (EU) 327/2011 para ventiladores, colaborando con el objetivo KIO-TO adoptado por la UE para la reducción de emisiones de CO2.

SOLUCIONES



Motores síncronos **Industrial Brushless EC** de imanes permanentes, con una eficiencia hasta un 27% superior a su equivalente asíncrono, además vienen equipados de serie con variador electrónico de velocidad (VSD).



Motores asíncronos trifásicos de **alto rendimiento IE3**, equipados según opción con variador electrónico de velocidad (VSD), adelantándose a los requerimientos de eficiencia del reglamento 2009/640/EC de motores eléctricos.



Los variadores electrónicos de velocidad (VSD) permiten regular la velocidad del ventilador para ajustarse a la demanda, obteniendo así un ahorro energético extra. SODECA dispone de una amplia gama de accesorios de control electrónico para su uso conjunto con el variador de velocidad. Podrá controlar temperatura, humedad, CO2 o presión de su instalación ajustando la velocidad del ventilador a la demanda. Además, los variadores electrónicos de velocidad (VSD) pueden conectarse en redes monofásicas o trifásicas con un amplio rango de tensiones y frecuencias de alimentación.

COMPARATIVA AHORRO ENERGÉTICO

Tan sólo con cambiar el ventilador que tiene instalado por uno con tecnología EC puede obtener un ahorro del 21% en su consumo eléctrico. Si además instala un control electrónico que gobierne el variador electrónico de velocidad (VSD) tendrá un sistema de demanda controlada de ventilación (DCV), obteniendo ahorros muy superiores.

En el siguiente caso se simula la demanda de ventilación de un edificio de oficinas en un día laborable (7-21h), según informe técnico "Demand Controlled Ventilation Systems" Anexo 18 de la Agencia Internacional de la Energía (IEA).

A continuación se muestra el ahorro energético que se obtiene substituyendo el sistema convencional de ventilación del caso anterior por uno EC con demanda controlada de ventilación, el porcentaje de ahorro promedio es del 50%.

El ahorro energético permite amortizar rápidamente el sobre coste del equipo EC, siendo una opción rentable con o sin sistema de demanda controlada de ventilación.

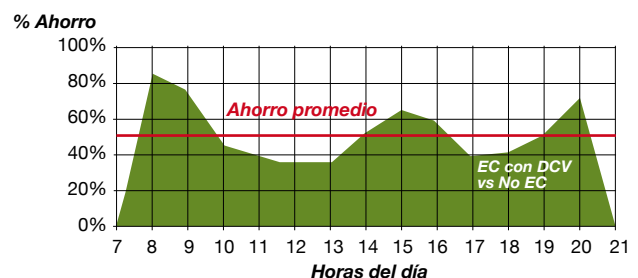
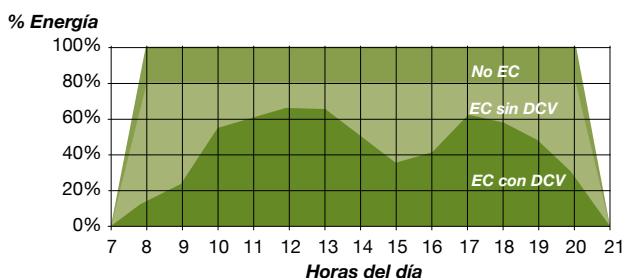

EFFICIENT WORK FANS



SOLution DEVELOPMENT CAPacity

Fast and flexible industrial fan solutions and tailored fans
 Large experience in smoke control systems and ATEX applications
 Wide range of certified products for specific markets

VENTILADORES
 HELICOIDALES Y
 EXTRACTORES DE TEJADO



VENTILADORES
 CENTRÍFUGOS Y EXTRACTORES
 EN LÍNEA



EXTRACTORES
 PARA EVACUACIÓN
 DE HUMOS



EXTRACTORES PARA
 ATMÓSFERAS EXPLOSIVAS ATEX
 Y OTRAS APLICACIONES



RECUPERADORES DE
 CALOR Y UNIDADES DE
 FILTRACIÓN



CORTINAS DE AIRE PARA
 APLICACIONES COMERCIALES
 E INDUSTRIALES



SISTEMAS DE VENTILACIÓN PARA
 VIVIENDAS



**Solicítenos
 información**



Crta. de Berga, km 0.7
 E-08580 St. Quirze de Besora
 BARCELONA (Spain)
 Tel. +34 93 852 91 11
 Fax. +34 93 852 90 42

comercial@sodeca.com
Export sales: ventilation@sodeca.com
www.sodeca.com



CUMPLIMIENTO DE NORMAS

Los ventiladores y extractores de SODECA, cumplen con las siguientes normativas:

CALIDAD	
ISO 9001:2008	Sistemas de gestión de la calidad. Requisitos. Quality management systems -- Requirements
ENSAYOS	
ISO 5801	Ventiladores industriales. Ensayos de comportamiento en circuitos normalizados. Industrial fans -- Performance testing using standardized airways
AMCA 210-99	Ventiladores industriales. Métodos de ensayos de ventiladores y su representación de ensayos. Laboratory Methods of Testing Fans for Aerodynamic Performance Rating
UNE 100212:1990	Ventiladores. Dispositivos e instalaciones para el ensayo de ventiladores.
ISO 13350	Ventiladores industriales. Ensayos de comportamiento de ventiladores de chorro. Industrial fans -- Performance testing of jet fans
ISO 13348	Industrial fans -- Tolerances, methods of conversion and technical data presentation
VENTILADORES PARA ALTA TEMPERATURA	
EN 12101-3:2002	Sistemas de control de humos y calor. Parte 3: Especificaciones para aireadores extractores de humos y calor mecánicos. Smoke and heat control systems - Part 3: Specification for powered smoke and heat exhaust ventilators
ACÚSTICA	
ISO 3744	Acústica. Determinación de los niveles de potencia acústica de fuentes de ruido a partir de la presión acústica. Método de ingeniería para condiciones de campo libre sobre un plano reflectante. Acoustics -- Determination of sound power levels of noise sources using sound pressure -- Engineering method in an essentially free field over a reflecting plane
EQUILIBRADO Y VIBRACIONES	
ISO 1940-1	Vibraciones mecánicas. Calidad de equilibrado Mechanical vibration -- Balance quality requirements for rotors in a constant (rigid) state -- Part 1: Specification and verification of balance tolerances
ISO 10816-1	Vibraciones mecánicas. Evaluación de las vibraciones de máquinas Mechanical vibration -- Evaluation of machine vibration by measurements on non-rotating parts -- Part 1: General guidelines
ISO 14694	Ventiladores industriales. Especificaciones para equilibrado y niveles de vibración Industrial fans -- Specifications for balance quality and vibration levels
SEGURIDAD (Declaración de Conformidad CE)	
EN ISO 12100-1	Seguridad de las máquinas. Conceptos básicos, principios generales para el diseño. Parte 1: Terminología básica, metodología. Safety of machinery -- Basic concepts, general principles for design -- Part 1: Basic terminology, methodology
EN ISO 12100-2	Seguridad de las máquinas. Conceptos básicos, principios generales para el diseño. Parte 2: Principios técnicos. Safety of machinery -- Basic concepts, general principles for design -- Part 2: Technical principles
EN 60204-1	Seguridad de las máquinas. Equipo eléctrico de las máquinas. Parte 1: Requisitos generales. Safety of machinery - Electrical equipment of machines - Part 1: General requirements
ISO 13857	Seguridad de máquinas. Distancias de seguridad para impedir que se alcancen zonas peligrosas con los miembros superiores e inferiores. Safety of machinery -- Safety distances to prevent danger zones being reached by upper and lower limbs
UNE 100250	Ventiladores industriales. Seguridad mecánica de los ventiladores (equivalente ISO 12499)
ISO 12499	Ventiladores industriales. Seguridad mecánica en los ventiladores Industrial fans -- Mechanical safety of fans -- Guarding
DIRECTIVAS	
Directiva 2006/42/CE	Directiva de máquinas Machinery Directive
Directiva 2006/95/CE	Directiva de baja tensión Low Voltage Directive
Directiva 2004/108/CE	Directiva compatibilidad electromagnética EMC Directive
Directiva 89/106/CE	Directiva productos de construcción Construction Products Directive (CPD)
Directiva 2009/125/CE	Directiva de requisitos de diseño ecológico para productos que utilizan energía. Ecodesign Requirements for Energy-related Products Directive
EJECUCIONES ATEX	
Directiva ATEX 94/9/CE	Aparatos y sistemas de protección para uso en atmósferas potencialmente explosivas Equipment and protective systems intended for use in potentially explosive atmospheres
EN 14986	Diseño de ventiladores para trabajar en atmósferas potencialmente explosivas. Design of fans working in potentially explosive atmospheres
EN 13463-1	Equipos no eléctricos destinados a atmósferas potencialmente explosivas. Parte 1: Requisitos y metodología básica. Non-electrical equipment for use in potentially explosive atmospheres - Part 1: Basic method and requirements
EN 1127-1	Atmósferas explosivas. Prevención y protección contra la explosión. Parte 1: Conceptos básicos y metodología. Explosive atmospheres - Explosion prevention and protection - Part 1: Basic concepts and methodology



EFFICIENT WORK



EFFICIENT WORK FANS

EXTRACTORES EN LÍNEA PARA CONDUCTOS

SV/ECO



11

E.C.
BRUSHLESS

NEOLINEO/EW



13

E.C.
BRUSHLESS

VENTILADORES HELICOIDALES

HEP/EW



15

E.C.
BRUSHLESS

HEPT/EW



17

E.C.
BRUSHLESS

HC/EW



22

AC
IE3

**HCH/EW
HCT/EW HFT/EW**



26

AC
IE3

VENTILADORES CENTRÍFUGOS

**CBD/EW
CBD/B/EW**



34

E.C.
BRUSHLESS

**CJBD/EW
CJBD/EW/AL**



36

E.C.
BRUSHLESS

CJEC/EW



83

E.C.
BRUSHLESS

CMA/EW



41

E.C.
BRUSHLESS

CMP-L/EW



45

E.C.
BRUSHLESS

CMP/EW



50

AC
IE3

CMR-L/EW



57

E.C.
BRUSHLESS

CMR/EW



60

AC
IE3

CAS-L/EW



66

E.C.
BRUSHLESS

CAS/EW



70

AC
IE3



EFFICIENT WORK FANS

EXTRACTORES PARA EVACUACIÓN DE HUMOS F-400



F-400

TCR/R/EW
CJTCR/R/EW



76

CJLINE/EW



80

CJEC/EW



83

CHT/EW
CVT/EW



86

EXTRACTORES DE TEJADO

HT-L/EW



90

HT/EW



93

CHT/EW
CVT/EW



86

KIT SOBREPRESIÓN

KIT
SOBREPRESIÓN



96









EFFICIENT WORK



Ejemplo de configuración de control

E.C. **BRUSHLESS** **MOTOR BRUSHLESS INDUSTRIAL E.C.**

Consigna	Sensor	Control
MANUAL <small>(Opcional con código pedido D)</small>		 Control manual MTP010
TEMPERATURA <small>(Opcional con código pedido D)</small>		 Control SI-TEMP+ HUMEDAD
HUMEDAD TEMPERATURA <small>(Opcional con código pedido D)</small>	 Sonda humedad SI-HUMEDAD	 Control SI-TEMP+ HUMEDAD
CO2 <small>(Opcional con código pedido D)</small>		 Control CO2 SI-CO2-GAQ24 24V AC
PRESIÓN <small>(Incluido con código pedido P)</small>		 Transmisor de presión SI-PRESIÓN
KIT completo control presión <small>(Incluido con código pedido K)</small>		 BOXPRES KIT/B









VARIADOR VELOCIDAD
VSD: Variador electrónico de velocidad.
· VSD1/B
· VSD3/B

Suministro incluido con el ventilador

ALIMENTACIÓN
VSD1/B:
220-240 V 50/60 Hz
VSD3/B:
380-415 V 50/60 Hz

INCLUYE
Variador de velocidad VSD1/B ó VSD3/B
Sonda de presión diferencial
Magnetó térmico
Led de línea y fallo
Pulsador de chequeo

AC **IE3** **MOTORES TRIFÁSICOS DE ALTA Eficiencia IE3**

Consigna	Sensor	Control
MANUAL <small>(Opcional con código pedido D)</small>		 Control manual MTP010
TEMPERATURA <small>(Opcional con código pedido D)</small>		 Control SI-TEMP+ HUMEDAD
HUMEDAD TEMPERATURA <small>(Opcional con código pedido D)</small>	 Sonda humedad SI-HUMEDAD	 Control SI-TEMP+ HUMEDAD
CO2 <small>(Opcional con código pedido D)</small>		 Control CO2 SI-CO2-GAQ24 24V AC
PRESIÓN <small>(Incluido con código pedido P)</small>		 Transmisor de presión SI-PRESIÓN
KIT completo control presión <small>(Incluido con código pedido K)</small>		 BOXPRES KIT



VARIADOR VELOCIDAD
VSD: Variador electrónico de velocidad.
· VSD1/A-RFM
· VSD3/A-RFT

ALIMENTACIÓN
VSD1/A-RFM:
220-240 V 50/60 Hz
VSD3/A-RFT:
380-415 V 50/60 Hz

INCLUYE
Variador de velocidad VSD1/A-RFM ó VSD3/A-RFT
Sonda de presión diferencial
Magnetó térmico
Led de línea y fallo
Pulsador de chequeo

Ejemplo de configuración de control



Consigna	Sensor	Control
MANUAL		Control manual MTP010
TEMPERATURA		Control SI-TEMP+ HUMEDAD
HUMEDAD TEMPERATURA	Sonda humedad SI-HUMEDAD	Control SI-TEMP+ HUMEDAD
CO2		Control CO2 SI-CO2-GAQ24 24V AC
PRESIÓN		Control de presión SI-CONTROL PRESIÓN



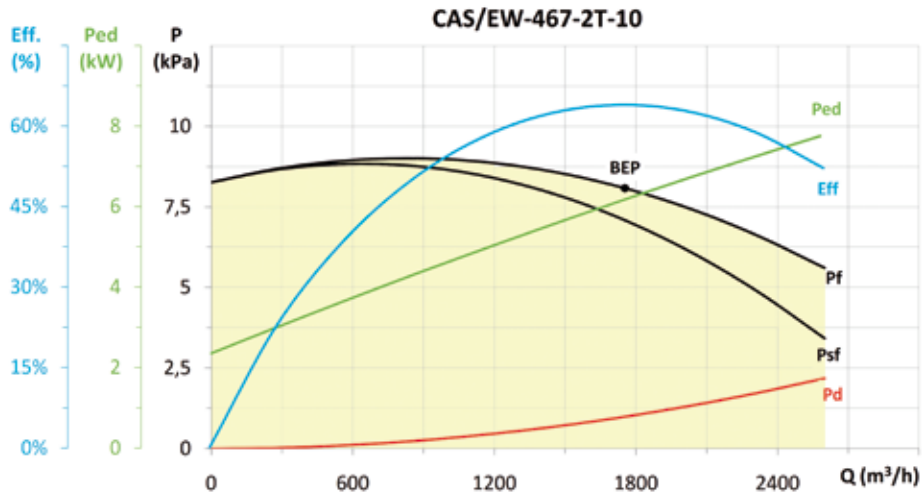

GUIA EXPLICATIVA CURVAS EW

Características ventilador a velocidad máxima



MC	EC	SR	Cc	η_e (%)*	N	[kW]	[m³/h]	[Pa]	[rpm]	VSD
B	T	1,08	1,04	66,5%	68,7	6,152	1754	8078,7	2954	NECESSARY

* η_e (%) = Eff. (%) x Cc

Nombre	Descripción	Unidades
Eff	Eficiencia estática o total según categoría eficiencia (EC)	%
Ped	Potencia eléctrica de entrada al VSD	W ó kW
Psf	Presión estática ventilador	Pa ó kPa
Pf	Presión total ventilador	Pa ó kPa
Pd	Presión dinámica ventilador	Pa ó kPa
Q	Caudal	m³/h

El ajuste de la velocidad del ventilador permite obtener una amplia área de trabajo por debajo de la curva Caudal-presión a velocidad máxima.

MC	Categoría de medición
EC	Categoría de eficiencia
S	Estática
T	Total
SR	Relación específica
Cc	Coefficiente de compensación de la carga parcial, se aplica al utilizar VSD
η_e [%]	Eficiencia global ErP, si se usa VSD debe multiplicarse por Cc (η_e (%) = Eff (%) x Cc)
N	Grado de eficiencia
[kW]	Potencia eléctrica
[m³/h]	Caudal
[Pa]	Presión estática o total (Según EC)
[RPM]	Velocidad
VSD	Variador de velocidad
NECESSARY	El ventilador debe instalarse con VSD
INCLUDED	El VSD se suministra con el ventilador
INTEGRATED	El VSD está integrado en el motor de ventilador



SV/ECO

MOTOR BRUSHLESS CON VSD INTEGRADO

CONTROL
 Suministro como accesorio opcional

Extractores en línea para conductos, con bajo nivel sonoro montados dentro de una envolvente acústica, con aislamiento de 50 mm, equipados con motor EC

Ventilador:

- Envolvente acústica recubierta de material fonoabsorbente.
- Todos los modelos equipados con turbina a reacción.
- Bridas normalizadas en aspiración e impulsión, para facilitar la instalación en conductos.
- Se suministran con 4 pies soporte, que facilita su montaje.
- Dirección aire sentido lineal.

Motor:

- Monofásicos 230 V 50/60 Hz.
- Temperatura máxima del aire a transportar: + 50 °C.
- Motor brushless-EC, de alta eficiencia controlados electrónicamente mediante un potenciómetro de 10 kΩ MTP010, o una señal exterior de 0-10 V.

Acabado:

- Anticorrosivo en resina de poliéster polimerizada a 190 °C, previo desengrase con tratamiento nanotecnológico libre de fosfatos.

Código de pedido

SV/ECO — 150/H

SV/ECO: Extractores en línea para conductos con motor EC y variador de velocidad integrado

Diámetro boca en mm

Características técnicas

Modelo	Velocidad (r/min)	Intensidad máxima admisible (A)	Potencia instalada (kW)	Caudal máximo (m³/h)	Nivel presión sonora a 50% de velocidad máx * dB(A)	Peso aprox. (Kg)
SV/ECO-125/H	4480	0,46	0,055	367	29	12
SV/ECO-160/H	3490	0,99	0,114	565	28	19
SV/ECO-200/H	3380	1,48	0,192	914	39	24
SV/ECO-250/H	3220	1,69	0,213	1107	32	24
SV/ECO-315/H	3580	2,8	0,448	1638	49	31

*Nivel de presión sonora en dB(A) obtenido a 1,5m de distancia.

Características acústicas a velocidad máxima

Los valores indicados se determinan mediante medidas de potencia sonora en dB(A) obtenidas en campo libre a una distancia equivalente a dos veces la envergadura del ventilador más el diámetro de la turbina, con un mínimo de 1,5m.

Espectro de potencia sonora Lw(A) en dB(A) banda de frecuencia en [Hz]

Modelo	63	125	250	500	1000	2000	4000	8000	Modelo	63	125	250	500	1000	2000	4000	8000
SV/ECO-125/H	31	41	54	56	45	45	40	44	SV/ECO-250/H	48	57	70	64	66	59	53	52
SV/ECO-160/H	39	49	63	60	49	51	48	46	SV/ECO-315/H	50	59	73	67	68	65	58	55
SV/ECO-200/H	42	52	66	60	56	54	51	52									

Dimensiones mm

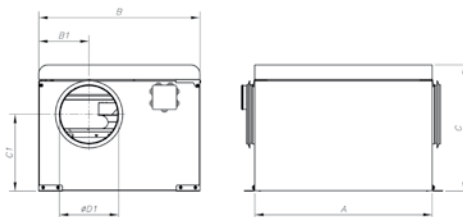

Modelo	A	B	B1	C	C1	øD1	øD2	E	F
SV/ECO-125	400	410	205	325	165,5	125	12,5	330	440
SV/ECO-160	550	485	149	340	194,5	160	12,5	405	590
SV/ECO-200	600	545	170	425	259,5	200	12,5	465	640
SV/ECO-250	600	545	194	425	234,5	250	12,5	465	640
SV/ECO-315	675	595	227,5	475	251,5	315	12,5	515	715



EFFICIENT WORK



Erp. Curvas características y datos ErP

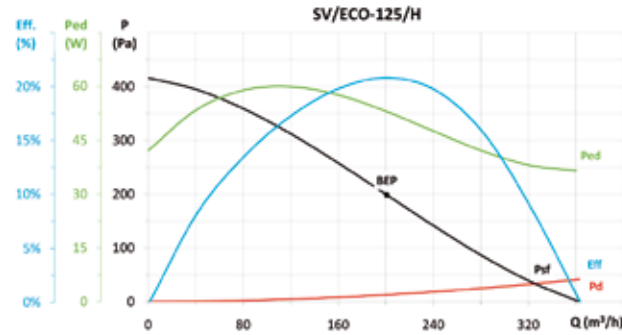

MC	EC	SR	Cc	η_e (%)*	N	[kW]	[m ³ /h]	[Pa]	[rpm]	VSD
A	S	-	-	-	-	0,053	201	198	4480	INTEGRATED

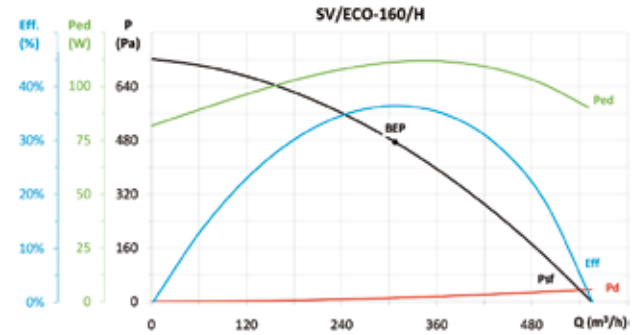

MC	EC	SR	Cc	η_e (%)*	N	[kW]	[m ³ /h]	[Pa]	[rpm]	VSD
A	S	-	-	-	-	0,111	308	474	3490	INTEGRATED

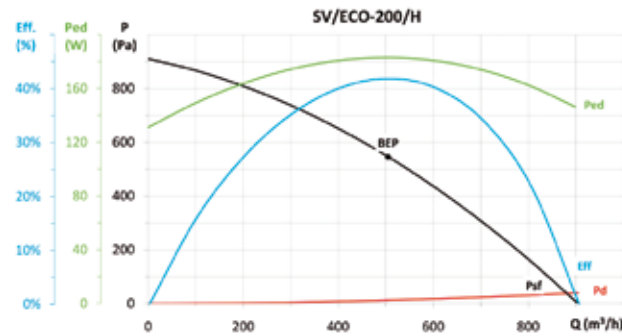

MC	EC	SR	Cc	η_e (%)*	N	[kW]	[m ³ /h]	[Pa]	[rpm]	VSD
A	S	1,01	1,14	47,7%	65,9	0,183	505	546	3380	INTEGRATED

* η_e (%) = Eff. (%) x Cc

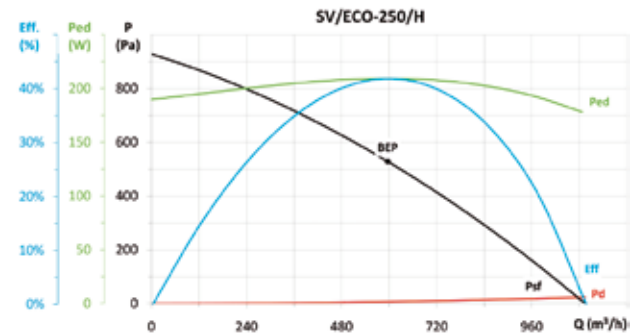

MC	EC	SR	Cc	η_e (%)*	N	[kW]	[m ³ /h]	[Pa]	[rpm]	VSD
A	S	1,01	1,13	47,5%	65,1	0,209	597	528	3220	INTEGRATED

* η_e (%) = Eff. (%) x Cc

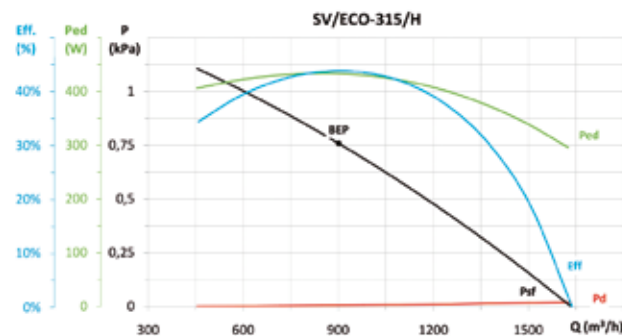

MC	EC	SR	Cc	η_e (%)*	N	[kW]	[m ³ /h]	[Pa]	[rpm]	VSD
A	S	1,01	1,11	48,8%	63,1	0,433	901	759	3580	INTEGRATED

* η_e (%) = Eff. (%) x Cc

Accesorios

Ver apartado accesorios.



Kits de entrada y salida



Rejillas rectangulares



Rejillas de protección



Rejillas circulares



Baterías eléctricas



Válvulas de mariposa



Bocas de salida



Bocas de captación



Bocas de aspiración/impulsión



Persianas de sobrepresión



Accesorios



Cajas de filtros de aire



UNIDADES DE CONTROL Y SENSORES



Entradas de aire para viviendas



Bocas de salida para viviendas



Silenciador



NEOLINEO/EW

**MOTOR
BRUSHLESS CON
VSD INTEGRADO**

Extractores en línea para conductos, con cuerpo extraíble y tamaño reducido, equipados con motor Brushless/EC

Ventilador:

- Envoltorio en material plástico autoextinguible V0.
- Caja de bornes externa, con posición variable.
- Instalación rápida y sencilla.

Motor:

- Motores Brushless/EC con rodamientos a bolas de Larga Duración.
- Protección IP44.
- Dos velocidades seleccionables mediante conmutador.
- Cada velocidad es regulable mediante potenciómetro en caja de bornes. Modelo 315 regulable mediante señal externa 0-10 V.

- Monofásicos 220-240 V 50 Hz.
- Temperatura de trabajo:
Modelos 100, 125 y 150: -10 °C +60 °C.
Modelos 200, 250 y 315: -10 °C +50 °C.

Acabado:

- En material plástico, de color blanco, autoextinguible al fuego V0.

CONTROL
Suministro como accesorio opcional

Código de pedido

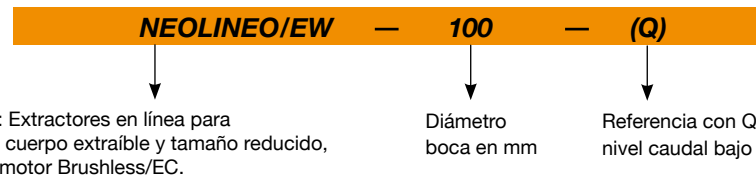

Características técnicas

Modelo	Regulación velocidad	Velocidad (r/min) min/max	Intensidad (A) min/max	Potencia (W) min/max	Caudal máximo (m ³ /h) min/max	Nivel de presión sonora Lp dB(A)* min/max	Peso aprox. (Kg)
NEOLINEO/EW-100-Q	Vel. Min.	1420/2120	0,05/0,08	4,5/7	90/145	21,0/33,3	1,5
	Vel. Nom.	2125/2850	0,07/0,12	7/12	155/210	28,9/40,0	1,5
	Vel. Max.	2560/3300	0,10/0,16	10/16,5	170/230	33,5/44,5	1,5
NEOLINEO/EW-100	Vel. Min.	1320/1650	0,06/0,09	5,5/8	140/185	25,3/31,4	1,9
	Vel. Nom.	1620/2000	0,09/0,12	8/12	180/255	31,4/36,4	1,9
	Vel. Max.	1920/2330	0,11/0,17	11/17	220/270	35,7/40,8	1,9
NEOLINEO/EW-125	Vel. Min.	1285/1660	0,07/0,11	6,5/10,5	190/270	28,9/35,1	1,8
	Vel. Nom.	1600/2040	0,10/0,17	10/17	250/365	34,8/40,3	1,8
	Vel. Max.	1870/2370	0,13/0,22	13,5/24	300/380	39,3/44,4	1,8
NEOLINEO/EW-150	Vel. Min.	1340/1895	0,10/0,20	10/22	325/440	35,0/44,1	2,2
	Vel. Nom.	1630/2230	0,15/0,31	15/35	385/550	41,6/47,1	2,2
	Vel. Max.	1870/2560	0,20/0,44	22/52	465/620	46,0/53,2	2,2
NEOLINEO/EW-160	Vel. Min.	1300/1900	0,10/0,21	10/23	325/450	33,8/44,6	2,1
	Vel. Nom.	1560/2290	0,15/0,33	15/38	385/570	39,2/47,7	2,1
	Vel. Max.	1830/2620	0,20/0,45	22/55	465/630	45,7/54,1	2,1
NEOLINEO/EW-200	Vel. Min.	1990/2330	0,21/0,32	22/34	620/760	39,4/44,3	2,5
	Vel. Nom.	2400/2820	0,33/0,50	36/57	750/1000	44,8/46,2	2,5
	Vel. Max.	2750/3120	0,47/0,63	53/74	870/1080	45,3/47,5	2,5
NEOLINEO/EW-250	Vel. Min.	1720/2280	0,26/0,54	27/59	650/850	43,0/50,9	5,3
	Vel. Nom.	2100/2750	0,42/0,83	45/95	800/1150	47,4/55,0	5,3
	Vel. Max.	2400/3010	0,59/1,06	65/124	920/1250	50,4/57,3	5,3
NEOLINEO/EW-315		1800/2350	0,83/1,60	119/240	1400/1900	53,2/60,7	9,5

*Los niveles de presión sonora irradiados, están obtenidos a 3 metros en campo libre, con tubos rígidos en la aspiración y descarga.

Dimensiones mm

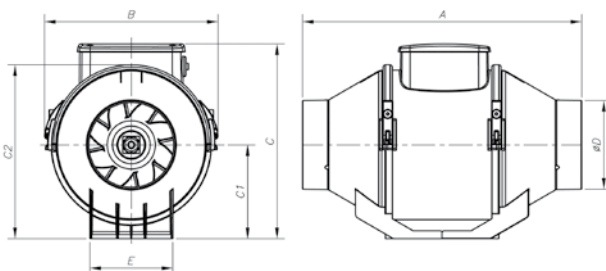

Modelo	A	B	C	C1	C2	øD	E
NEOLINEO/EW-100-Q	231	156	205	82	152	96	95
NEOLINEO/EW-100	303	188,5	240	101,5	189	96	90
NEOLINEO/EW-125	258	188,5	240	101,5	189	122	90
NEOLINEO/EW-150	294	214,5	265	112,5	212	146	110
NEOLINEO/EW-160	272,5	214,5	265	112,5	212	156	110
NEOLINEO/EW-200	300	234,5	290	125,5	235	196	140
NEOLINEO/EW-250	385	300	350	152,5	292	247	176,5
NEOLINEO/EW-315	448	361,5	460	188,5	359	312	220,5



EFFICIENT WORK



Erp. Curvas características y datos Erp

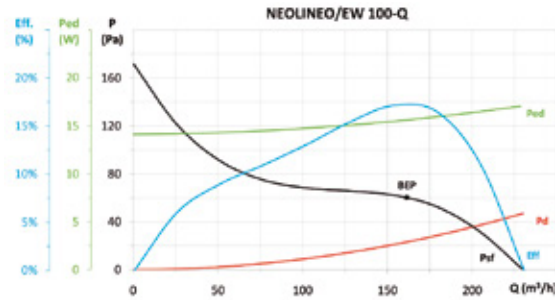

MC	EC	SR	Cc	η_e (%)*	N	[kW]	[m³/h]	[Pa]	[rpm]	VSD
A	S	-	-	-	-	0,016	161	60	3300	INTEGRATED

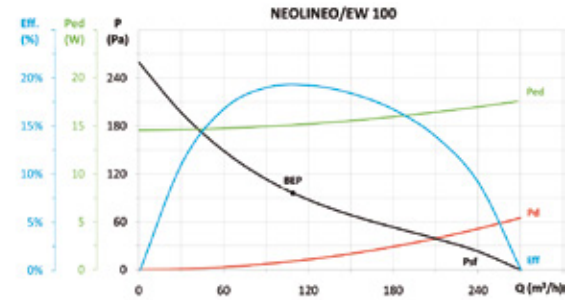

MC	EC	SR	Cc	η_e (%)*	N	[kW]	[m³/h]	[Pa]	[rpm]	VSD
A	S	-	-	-	-	0,015	109	96	2330	INTEGRATED

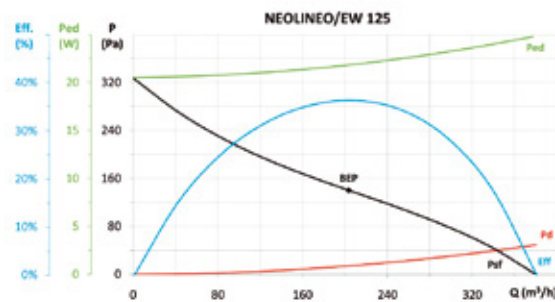

MC	EC	SR	Cc	η_e (%)*	N	[kW]	[m³/h]	[Pa]	[rpm]	VSD
A	S	-	-	-	-	0,022	203	140	2370	INTEGRATED

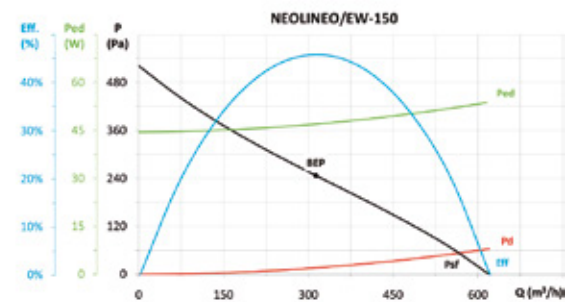

MC	EC	SR	Cc	η_e (%)*	N	[kW]	[m³/h]	[Pa]	[rpm]	VSD
A	S	-	-	-	-	0,047	313	247	2560	INTEGRATED

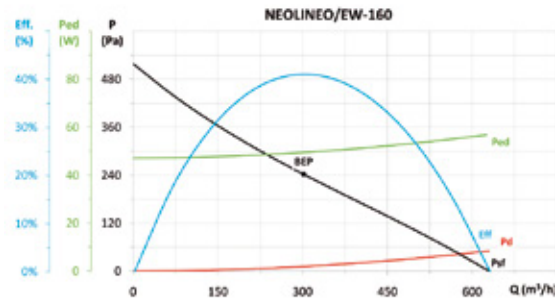

MC	EC	SR	Cc	η_e (%)*	N	[kW]	[m³/h]	[Pa]	[rpm]	VSD
A	S	-	-	-	-	0,049	301	242	2620	INTEGRATED

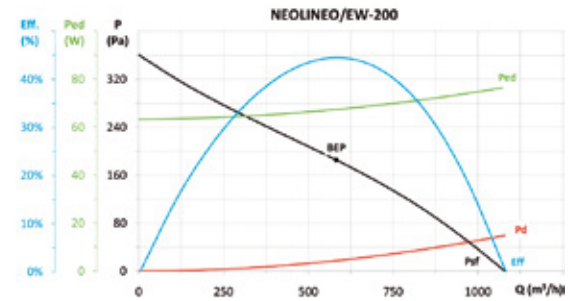

MC	EC	SR	Cc	η_e (%)*	N	[kW]	[m³/h]	[Pa]	[rpm]	VSD
A	S	-	-	-	-	0,067	582	185	3120	INTEGRATED

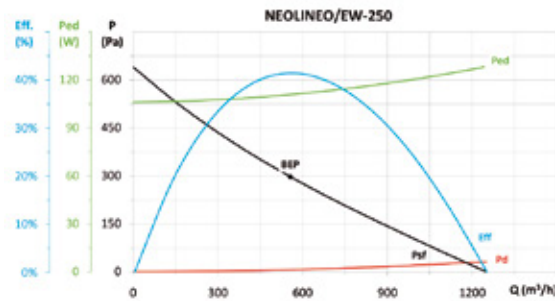

MC	EC	SR	Cc	η_e (%)*	N	[kW]	[m³/h]	[Pa]	[rpm]	VSD
A	S	-	-	-	-	0,111	556	297	3010	INTEGRATED

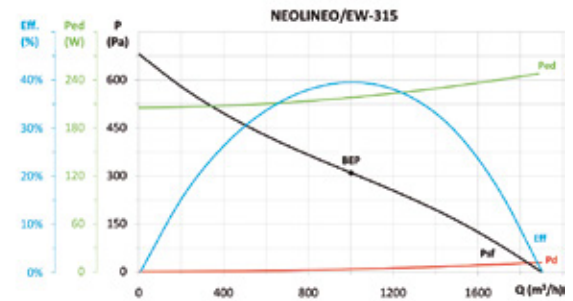

MC	EC	SR	Cc	η_e (%)*	N	[kW]	[m³/h]	[Pa]	[rpm]	VSD
A	S	1,00	1,13	44,8%	62,3	0,218	8002	309	2350	INTEGRATED

* η_e (%) = EFF (%) × Cc

Accesorios

Ver apartado accesorios.





HEP/EW



VARIADOR VELOCIDAD
VSD: Variador electrónico de velocidad.
· VSD1/B
· VSD3/B

Suministro incluido con el ventilador

CONTROL
Suministro como accesorio opcional

ALIMENTACIÓN
VSD1/B:
220-240 V 50/60 Hz
VSD3/B:
380-415 V 50/60 Hz

Ventiladores helicoidales murales de alta eficiencia, equipados con motor Brushless industrial E.C.

Hélice de plástico reforzada en fibra de vidrio.

Ventilador:

- Dirección aire motor-hélice.
- Hélice en poliamida 6 reforzada con fibra de vidrio.
- Marco soporte en chapa de acero.
- Rejilla de protección contra contactos según norma UNE 100250.
- Variador electrónico de velocidad (VSD), monofásico o trifásico, incluido con el ventilador.

Motor y variador electrónico :

- Motores brushless industriales E.C. de muy alta eficiencia, equipados con variador electrónico de velocidad (VSD), regulable mediante señal externa de control 0-10 V.
- Se recomienda instalar el variador electrónico de velocidad (VSD) fuera de la zona de trabajo.
- La señal externa puede suministrarse a través de un control manual o automático con salida 0-10 V.
- Variador electrónico de velocidad (VSD), disponibles con entrada monofásica 220-240 V 50/60 Hz (Tipo VSD1/B) o trifásica 380-415 V 50/60 Hz (Tipo VSD3/B).
- Por defecto se entrega el variador electrónico

de velocidad (VSD) programado a velocidad constante.

- Temperatura de trabajo ventilador: -25 °C +60 °C.
- Temperatura de trabajo (VSD): -25 °C +50 °C.

Acabado:

- Anticorrosivo en resina de poliéster polimerizada a 190 °C, previo desengrase con tratamiento nanotecnológico libre de fosfatos.

Bajo demanda:

- Conjunto motor, hélice y rejilla (versión F).
- Grupo motor hélice (versión G).
- Dirección aire hélice-motor.

Código de pedido con suministro de variador electrónico (VSD) incluido

HEP/EW — 25 — 2/H — B — T — D

HEP/EW: Ventiladores helicoidales murales de alta eficiencia "Efficient work"

Diámetro hélice en cm.

Velocidad máxima:
2=2850 rpm
4=1410 rpm
6=960 rpm

H=Caudal alto
L=Caudal bajo

Motores Brushless industriales E.C.

M: Equipados con VSD1/B, variador electrónico de velocidad, alimentación monofásica 220-240 V 50/60 Hz.
T: Equipados con VSD3/B, variador electrónico de velocidad, alimentación trifásica 380-415 V 50/60 Hz.

D: Versión estándar, suministro del VSD programado a velocidad constante.
P: Suministro con VSD programado para control de presión y transmisor de presión Si-Presión
K: Suministro con VSD programado e integrado en una caja BOXPRES KIT/B para el control de presión.

Características técnicas

Modelo	Velocidad min/max (r/min)	VSD monofásico 230 V 50/60 Hz		VSD trifásico 400 V 50/60 Hz		Potencia eléctrica máxima (W)	Caudal máximo min/max (m³/h)	Nivel presión sonora min/max dB(A)	Peso aprox. (Kg)
		Intensidad máxima entrada (A)	Modelo VSD	Intensidad máxima entrada (A)	Modelo VSD				
HEP/EW-25-2/H	300 / 2850	2,09	VSD1/B-0.37	0,61	VSD3/B-0.75	255	240 / 2300	15 / 64	5,3
HEP/EW-25-4/H	300 / 1410	1,14	VSD1/B-0.37	0,34	VSD3/B-0.75	140	265 / 1250	18 / 52	4,5
HEP/EW-31-2/H	300 / 2850	2,86	VSD1/B-0.37	0,84	VSD3/B-0.75	345	420 / 4000	25 / 74	7,0
HEP/EW-31-4/H	300 / 1410	1,14	VSD1/B-0.37	0,34	VSD3/B-0.75	140	510 / 2400	21 / 55	5,7
HEP/EW-35-2/H	300 / 2850	4,08	VSD1/B-0.37	1,20	VSD3/B-0.75	495	635 / 6020	27 / 76	8,8
HEP/EW-35-4/H	300 / 1410	1,14	VSD1/B-0.37	0,34	VSD3/B-0.75	140	745 / 3500	24 / 58	7,1
HEP/EW-40-4/H	300 / 1410	2,79	VSD1/B-0.37	0,82	VSD3/B-0.75	340	1105 / 5200	27 / 61	10,6
HEP/EW-40-6/H	300 / 960	2,13	VSD1/B-0.37	0,62	VSD3/B-0.75	255	1095 / 3500	29 / 54	10,2
HEP/EW-45-4/H	300 / 1410	3,96	VSD1/B-0.37	0,93	VSD3/B-0.75	450	1555 / 7300	32 / 66	12,5
HEP/EW-45-4/L	300 / 1410	2,79	VSD1/B-0.37	0,82	VSD3/B-0.75	340	1235 / 5810	30 / 64	11,0
HEP/EW-45-6/H	300 / 960	2,13	VSD1/B-0.37	0,62	VSD3/B-0.75	255	1530 / 4900	31 / 56	11,4
HEP/EW-50-4/H	300 / 1410	5,82	VSD1/B-0.75	1,37	VSD3/B-1.5	660	2160 / 10150	35 / 69	15,0
HEP/EW-50-4/L	300 / 1410	2,79	VSD1/B-0.37	0,82	VSD3/B-0.75	340	1555 / 7300	33 / 67	13,0
HEP/EW-50-6/H	300 / 960	2,13	VSD1/B-0.37	0,62	VSD3/B-0.75	255	1920 / 6150	34 / 59	13,2



EFFICIENT WORK



Características técnicas

Modelo	Velocidad min/max (r/min)	VSD monofásico 230 V 50/60 Hz		VSD trifásico 400 V 50/60 Hz		Potencia eléctrica máxima (W)	Caudal máximo min/max (m³/h)	Nivel presión sonora min/max dB(A)	Peso aprox. (Kg)
		Intensidad máxima entrada (A)	Modelo VSD	Intensidad máxima entrada (A)	Modelo VSD				
HEP/EW-56-4/H	300 / 1410	7,94	VSD1/B-0.75	1,87	VSD3/B-1.5	905	2725 / 12800	38 / 72	21,0
HEP/EW-56-4/L	300 / 1410	5,82	VSD1/B-0.75	1,37	VSD3/B-1.5	660	2320 / 10900	36 / 70	19,0
HEP/EW-56-6/H	300 / 960	2,93	VSD1/B-0.37	0,68	VSD3/B-0.75	330	2580 / 8250	37 / 62	17,0
HEP/EW-63-4/H	300 / 1410	11,25	VSD1/B-0.75	2,65	VSD3/B-1.5	1295	3980 / 18700	48 / 82	25,8
HEP/EW-63-4/L	300 / 1410	7,94	VSD1/B-0.75	1,87	VSD3/B-1.5	905	3510 / 16500	41 / 75	23,0
HEP/EW-63-6/H	300 / 960	4,28	VSD1/B-0.75	1,00	VSD3/B-1.5	480	3765 / 12050	40 / 65	20,2

Dimensiones mm

Versión de serie con caja de conexión

Versión bajo demanda sin caja de conexión

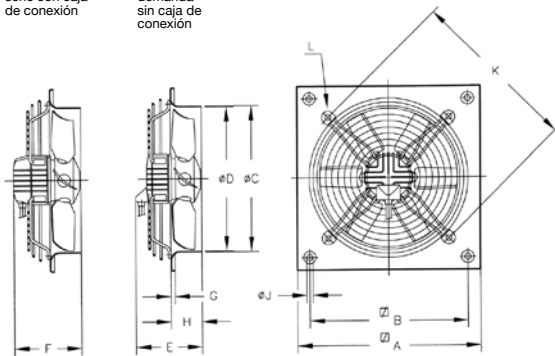

	A	B	C	D	E	F	G	H	J	K	L
HEP/EW-25-2/H	330	275	262	260	189	213	11	56	8,5	310	M.8
HEP/EW-25-4/H	330	275	262	260	179	203	11	56	8,5	310	M.8
HEP/EW-31-2/H	400	336	310,5	308	190	214	11	75	10,5	380	M.8
HEP/EW-31-4/H	400	336	310,5	308	180	204	11	75	10,5	380	M.8
HEP/EW-35-2/H	465	390	362,5	360	217	241	11	86	10,5	450	M.8
HEP/EW-35-4/H	465	390	362,5	360	187	211	11	86	10,5	450	M.8
HEP/EW-40-4/H	532	452	412,5	410	206	226	11	97,5	10,5	500	M.8
HEP/EW-40-6/H	532	452	412,5	410	186	205	11	97,5	10,5	500	M.8
HEP/EW-45-4/H	596	504	462,5	460	214	234	11	105	10,5	560	M.8
HEP/EW-45-4/L	596	504	462,5	460	214	234	11	105	10,5	560	M.8
HEP/EW-45-6/H	596	504	462,5	460	199	218	11	105	10,5	560	M.8
HEP/EW-50-4/H	665	562	516,5	514	255	275	11	115	10,5	640	M.8
HEP/EW-50-4/L	665	562	516,5	514	240	260	11	115	10,5	640	M.8
HEP/EW-50-6/H	665	562	516,5	514	235	254	11	115	10,5	640	M.8
HEP/EW-56-4/H	710	630	563	560	287	306	15	115	10,5	721	M.8
HEP/EW-56-4/L	710	630	563	560	267	286	15	115	10,5	721	M.8
HEP/EW-56-6/H	710	630	563	560	247	266	15	115	10,5	721	M.8
HEP/EW-63-4/H	800	710	638	635	320	340	15	140	10,5	820	M.8
HEP/EW-63-4/L	800	710	638	635	320	340	15	140	10,5	820	M.8
HEP/EW-63-6/H	800	710	638	635	257	276	15	140	10,5	820	M.8

Características acústicas a velocidad máxima

Los valores indicados se determinan mediante medidas de potencia sonora en dB(A) obtenidas en campo libre a una distancia equivalente a dos veces la envergadura del ventilador más el diámetro de la turbina, con un mínimo de 1,5m.

Espectro de potencia sonora Lw(A) en dB(A) banda de frecuencia en [Hz]

Modelo	63	125	250	500	1000	2000	4000	8000	Modelo	63	125	250	500	1000	2000	4000	8000
HEP/EW-25-2/H	39	52	64	68	70	70	66	58	HEP/EW-45-6/H	33	47	59	62	64	65	61	52
HEP/EW-25-4/H	27	40	52	56	58	58	54	46	HEP/EW-50-4/H	46	60	72	75	77	78	74	65
HEP/EW-31-2/H	49	62	74	78	80	80	76	68	HEP/EW-50-4/L	44	58	70	73	75	76	72	63
HEP/EW-31-4/H	30	43	55	59	61	61	57	49	HEP/EW-50-6/H	36	50	62	65	67	68	64	55
HEP/EW-35-2/H	51	64	76	80	82	82	78	70	HEP/EW-56-4/H	49	63	75	78	80	81	77	68
HEP/EW-35-4/H	33	46	58	62	64	64	60	52	HEP/EW-56-4/L	47	61	73	76	78	79	75	66
HEP/EW-40-4/H	36	49	61	65	67	67	63	55	HEP/EW-56-6/H	39	53	65	68	70	71	67	58
HEP/EW-40-6/H	29	42	54	58	60	60	56	48	HEP/EW-63-4/H	61	75	87	90	92	92	89	80
HEP/EW-45-4/H	43	57	69	72	74	75	71	62	HEP/EW-63-4/L	54	68	80	83	85	85	82	73
HEP/EW-45-4/L	41	55	67	70	72	73	69	60	HEP/EW-63-6/H	44	58	70	73	75	75	72	63



Erp. Curvas características y datos ErP

Ver curvas modelo HEP/EW-HEPT/EW

Accesorios

Ver apartado accesorios.



HEPT/EW



VARIADOR VELOCIDAD
VSD: Variador electrónico de velocidad.

. VSD1/B

. VSD3/B

Suministro incluido con el ventilador

CONTROL

Suministro como accesorio opcional

ALIMENTACIÓN

VSD1/B:

220-240 V 50/60 Hz

VSD3/B:

380-415 V 50/60 Hz

Ventiladores helicoidales tubulares de alta eficiencia, equipados con motor Brushless industrial E.C.

Hélice de plástico reforzada en fibra de vidrio.

Ventilador:

- Dirección aire motor-hélice.
- Hélice en poliamida 6 reforzada con fibra de vidrio.
- Envoltente tubular en chapa de acero.
- Caja de conexión en el exterior, protección IP65.
- Variador electrónico de velocidad (VSD), monofásico o trifásico, incluido con el ventilador.

Motor y variador electrónico :

- Motores brushless industriales E.C. de muy alta eficiencia, equipados con variador electrónico de velocidad (VSD), regulable mediante señal externa de control 0-10 V.
- Se recomienda instalar el variador electrónico de velocidad (VSD) fuera de la zona de trabajo.
- La señal externa puede subministrarse a través de un control manual o automático con salida 0-10 V.
- Variador electrónico de velocidad (VSD), disponibles con entrada monofásica 220-240 V 50/60 Hz (Tipo VSD1/B) o trifásica 380-415 V 50/60 Hz (Tipo VSD3/B).

- Por defecto se entrega el variador electrónico de velocidad (VSD) programado a velocidad constante.
- Temperatura de trabajo ventilador: -25 °C +60 °C.
- Temperatura de trabajo (VSD): -25 °C +50 °C.

Acabado:

- Anticorrosivo en resina de poliéster polimerizada a 190 °C, previo desengrase con tratamiento nanotecnológico libre de fosfatos.

Bajo demanda:

- Conjunto motor, hélice y rejilla (versión F).
- Dirección aire hélice-motor.

Código de pedido con suministro de variador electrónico (VSD) incluido

HEPT/EW — 31 — 2/H — B — T — D

HEPT/EW: Ventiladores helicoidales tubulares de alta eficiencia, "Efficient work"

Diámetro hélice en cm.

Velocidad máxima:
2=2850 rpm
4=1410 rpm
6=960 rpm

H=Caudal alto
L=Caudal bajo

Motores Brushless industriales E.C.

M: Equipados con VSD1/B, variador electrónico de velocidad, alimentación monofásica 220-240 V 50/60 Hz.

T: Equipados con VSD3/B, variador electrónico de velocidad, alimentación trifásica 380-415 V 50/60 Hz.

D: Versión estándar, suministro del VSD programado a velocidad constante.
P: Suministro con VSD programado para control de presión y transmisor de presión Si-Presión
K: Suministro con VSD programado e integrado en una caja BOXPRES KIT/B para el control de presión.

Características técnicas

Modelo	Velocidad min/max (r/min)	VSD monofásico 230 V 50/60 Hz		VSD trifásico 400 V 50/60 Hz		Potencia eléctrica máxima (W)	Caudal máximo min/max (m³/h)	Nivel presión sonora min/max dB(A)	Peso aprox. (Kg)
		Intensidad máxima entrada (A)	Modelo VSD	Intensidad máxima entrada (A)	Modelo VSD				
HEPT/EW-31-2/H	300 / 2850	2,86	VSD1/B-0.37	0,84	VSD3/B-0.75	345	420 / 4000	25 / 74	7,4
HEPT/EW-31-4/H	300 / 1410	1,14	VSD1/B-0.37	0,34	VSD3/B-0.75	140	510 / 2400	21 / 55	6,2
HEPT/EW-35-2/H	300 / 2850	4,08	VSD1/B-0.37	1,20	VSD3/B-0.75	495	635 / 6020	27 / 76	9,4
HEPT/EW-35-4/H	300 / 1410	1,14	VSD1/B-0.37	0,34	VSD3/B-0.75	140	745 / 3500	24 / 58	7,6
HEPT/EW-40-4/H	300 / 1410	2,79	VSD1/B-0.37	0,82	VSD3/B-0.75	340	1105 / 5200	27 / 61	13,5
HEPT/EW-40-6/H	300 / 960	2,13	VSD1/B-0.37	0,62	VSD3/B-0.75	255	1095 / 3500	29 / 54	13,5
HEPT/EW-45-4/H	300 / 1410	3,96	VSD1/B-0.37	0,93	VSD3/B-0.75	450	1555 / 7300	32 / 66	15,5
HEPT/EW-45-4/L	300 / 1410	2,79	VSD1/B-0.37	0,82	VSD3/B-0.75	340	1235 / 5810	30 / 64	15,5
HEPT/EW-45-6/H	300 / 960	2,13	VSD1/B-0.37	0,62	VSD3/B-0.75	255	1530 / 4900	31 / 56	15,5
HEPT/EW-50-4/H	300 / 1410	5,82	VSD1/B-0.75	1,37	VSD3/B-1.5	660	2160 / 10150	35 / 69	18,0
HEPT/EW-50-4/L	300 / 1410	2,79	VSD1/B-0.37	0,82	VSD3/B-0.75	340	1555 / 7300	33 / 67	18,0
HEPT/EW-50-6/H	300 / 960	2,13	VSD1/B-0.37	0,62	VSD3/B-0.75	255	1920 / 6150	34 / 59	18,0
HEPT/EW-56-4/H	300 / 1410	7,94	VSD1/B-0.75	1,87	VSD3/B-1.5	905	2725 / 12800	38 / 72	28,0



EFFICIENT WORK



Características técnicas

Modelo	Velocidad min/max (r/min)	VSD monofásico 230 V 50/60 Hz		VSD trifásico 400 V 50/60 Hz		Potencia eléctrica máxima (W)	Caudal máximo min/max (m³/h)	Nivel presión sonora min/max dB(A)	Peso aprox. (Kg)
		Intensidad máxima entrada (A)	Modelo VSD	Intensidad máxima entrada (A)	Modelo VSD				
HEPT/EW-56-4/L	300 / 1410	5,82	VSD1/B-0.75	1,37	VSD3/B-1.5	660	2320 / 10900	36 / 70	28,0
HEPT/EW-56-6/H	300 / 960	2,93	VSD1/B-0.37	0,68	VSD3/B-0.75	330	2580 / 8250	37 / 62	28,0
HEPT/EW-63-4/H	300 / 1410	11,25	VSD1/B-0.75	2,65	VSD3/B-1.5	1295	3980 / 18700	48 / 82	33,5
HEPT/EW-63-4/L	300 / 1410	7,94	VSD1/B-0.75	1,87	VSD3/B-1.5	905	3510 / 16500	41 / 75	33,5
HEPT/EW-63-6/H	300 / 960	4,28	VSD1/B-0.75	1,00	VSD3/B-1.5	480	3765 / 12050	40 / 65	33,5

Características acústicas a velocidad máxima

Los valores indicados, se determinan mediante medidas de nivel de presión y potencia sonora en dB(A) obtenidas en campo libre a una distancia equivalente a dos veces la envergadura del ventilador más el diámetro de la hélice, con un mínimo de 1.5 mts.

Espectro de potencia sonora Lw(A) en dB(A) banda de frecuencia en [Hz]

Modelo	63	125	250	500	1000	2000	4000	8000	Modelo	63	125	250	500	1000	2000	4000	8000
HEPT/EW-31-2/H	49	62	74	78	80	80	76	68	HEPT/EW-50-4/H	46	60	72	75	77	78	74	65
HEPT/EW-31-4/H	30	43	55	59	61	61	57	49	HEPT/EW-50-4/L	44	58	70	73	75	76	72	63
HEPT/EW-35-2/H	51	64	76	80	82	82	78	70	HEPT/EW-50-6/H	36	50	62	65	67	68	64	55
HEPT/EW-35-4/H	33	46	58	62	64	64	60	52	HEPT/EW-56-4/H	49	63	75	78	80	81	77	68
HEPT/EW-40-4/H	36	49	61	65	67	67	63	55	HEPT/EW-56-4/L	47	61	73	76	78	79	75	66
HEPT/EW-40-6/H	29	42	54	58	60	60	56	48	HEPT/EW-56-6/H	39	53	65	68	70	71	67	58
HEPT/EW-45-4/H	43	57	69	72	74	75	71	62	HEPT/EW-63-4/H	61	75	87	90	92	92	89	80
HEPT/EW-45-4/L	41	55	67	70	72	73	69	60	HEPT/EW-63-4/L	54	68	80	83	85	85	82	73
HEPT/EW-45-6/H	33	47	59	62	64	65	61	52	HEPT/EW-63-6/H	44	58	70	73	75	75	72	63

Dimensiones mm

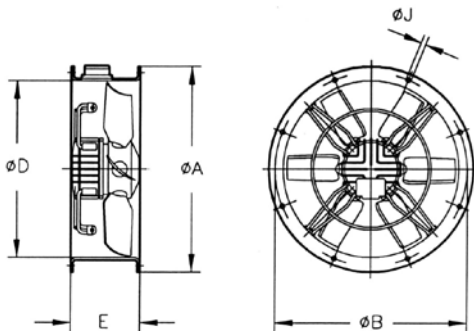

Modelo	ØA	ØB	ØD	E	ØJ	NºTaladros
HEPT/EW-31	385	355	308	200	10	8
HEPT/EW-35	425	395	360	220	10	8
HEPT/EW-40	490	450	410	220	12	8
HEPT/EW-45	540	500	460	220	12	8
HEPT/EW-50	600	560	514	230	12	12
HEPT/EW-56	660	620	560	260	12	12
HEPT/EW-63	730	690	635	350	12	12



Erp. Curvas características y datos ErP

Ver curvas modelo HEP/EW-HEPT/EW

Accesorios

Ver apartado accesorios.



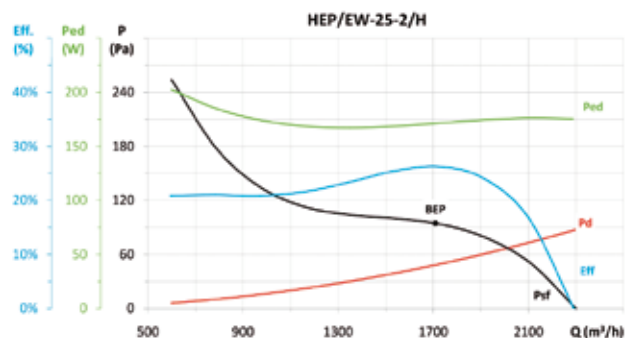

Erp. Curvas características y datos Erp.
Modelos HEP/EW - HEPT/EW

MC	EC	SR	Cc	η_b (%)*	N	[kW]	[m ³ /h]	[Pa]	[rpm]	VSD
A	S	1,00	1,14	29,9%	41,1	0,171	1709	94,7	2850	INCLUDED

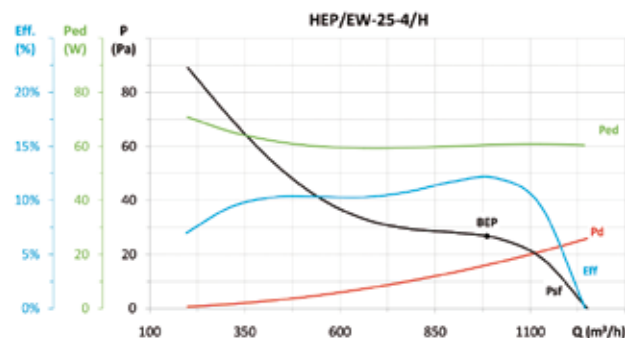
* η_e (%) = Eff. (%) x Cc

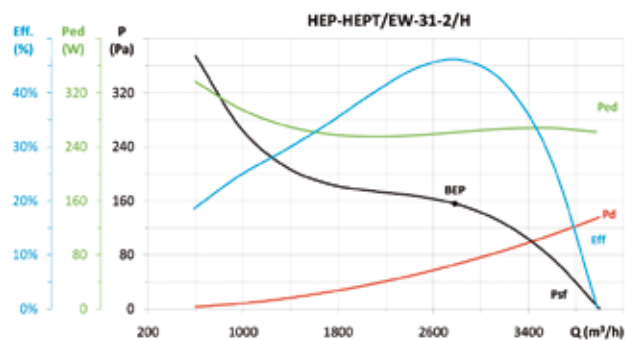

MC	EC	SR	Cc	η_b (%)*	N	[kW]	[m ³ /h]	[Pa]	[rpm]	VSD
A	S	-	-	-	-	0,061	986	26,8	1410	INCLUDED



MC	EC	SR	Cc	η_b (%)*	N	[kW]	[m ³ /h]	[Pa]	[rpm]	VSD
A	S	1,00	1,13	52,0%	62,0	0,261	2782	155,9	2850	INCLUDED

* η_e (%) = Eff. (%) x Cc

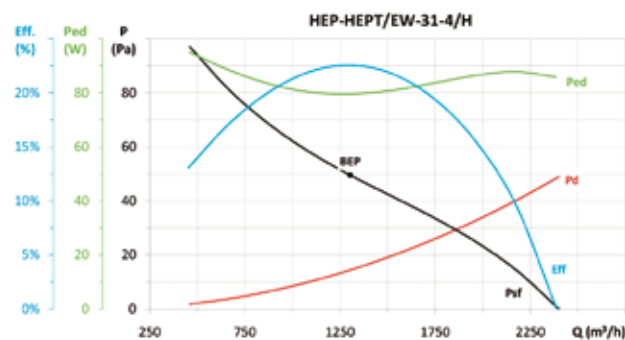

MC	EC	SR	Cc	η_b (%)*	N	[kW]	[m ³ /h]	[Pa]	[rpm]	VSD
A	S	-	-	-	-	0,080	1304	49,5	1410	INCLUDED

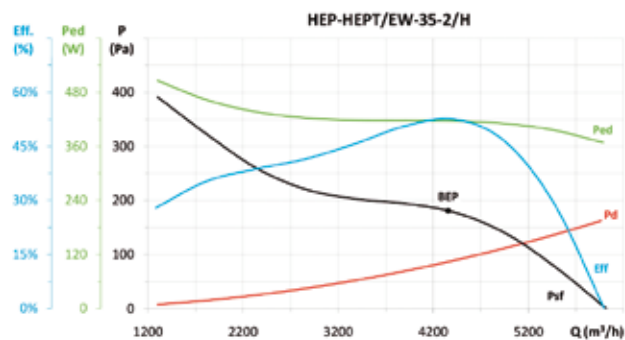

MC	EC	SR	Cc	η_b (%)*	N	[kW]	[m ³ /h]	[Pa]	[rpm]	VSD
A	S	1,00	1,11	58,5%	67,3	0,417	4356	181,1	2850	INCLUDED

* η_e (%) = Eff. (%) x Cc

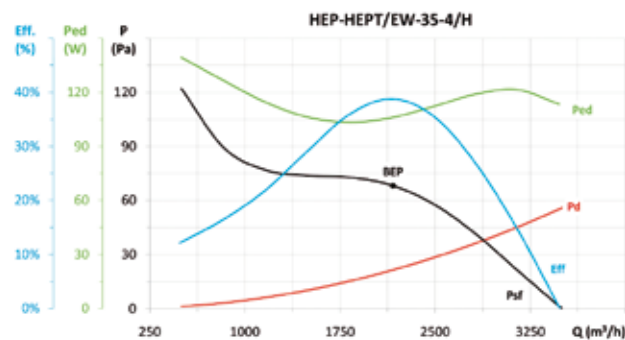

MC	EC	SR	Cc	η_b (%)*	N	[kW]	[m ³ /h]	[Pa]	[rpm]	VSD
A	S	-	-	-	-	0,106	2167	68,2	1410	INCLUDED

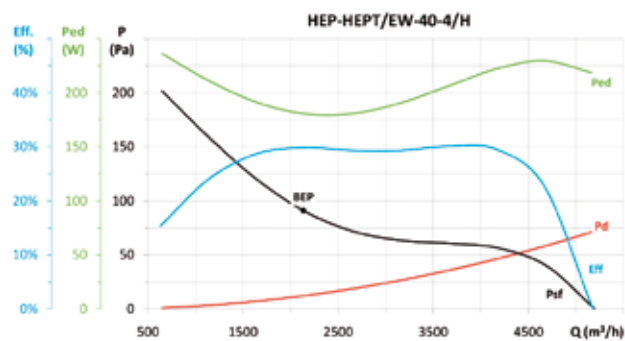

MC	EC	SR	Cc	η_b (%)*	N	[kW]	[m ³ /h]	[Pa]	[rpm]	VSD
A	S	1,00	1,14	34,0%	45,0	0,181	2135	91,0	1410	INCLUDED

* η_e (%) = Eff. (%) x Cc

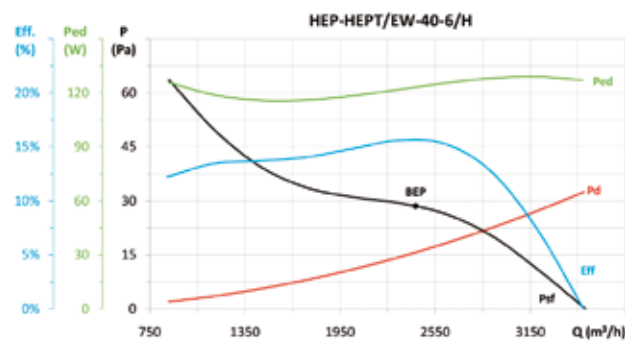

MC	EC	SR	Cc	η_b (%)*	N	[kW]	[m ³ /h]	[Pa]	[rpm]	VSD
A	S	-	-	-	-	0,123	2428	28,6	960	INCLUDED



EFFICIENT WORK



Erp. Curvas características y datos Erp.

Modelos HEP/EW - HEPT/EW

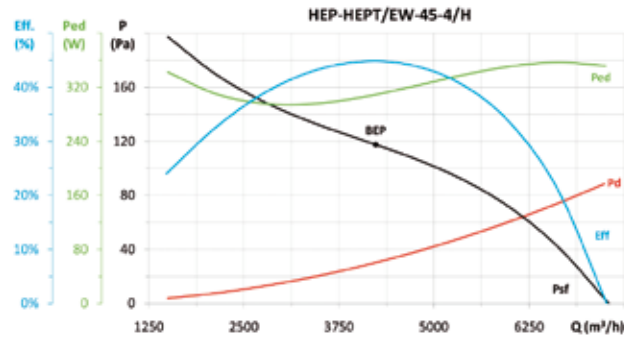

MC	EC	SR	Cc	η_b (%)*	N	[kW]	[m³/h]	[Pa]	[rpm]	VSD
A	S	1,00	1,12	50,3%	59,8	0,309	4235	117,6	1410	INCLUDED

* η_e (%) = EFF. (%) x Cc

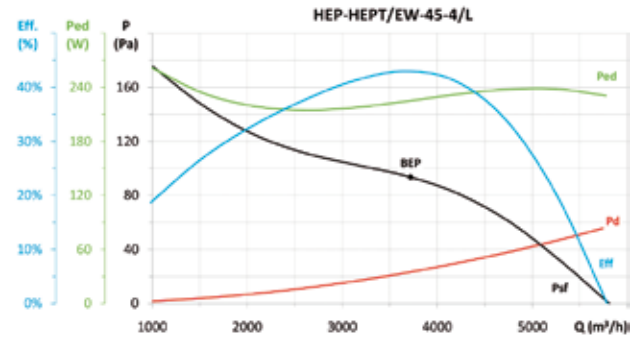

MC	EC	SR	Cc	η_b (%)*	N	[kW]	[m³/h]	[Pa]	[rpm]	VSD
A	S	1,00	1,13	48,6%	59,0	0,225	3719	93,5	1410	INCLUDED

* η_e (%) = EFF. (%) x Cc

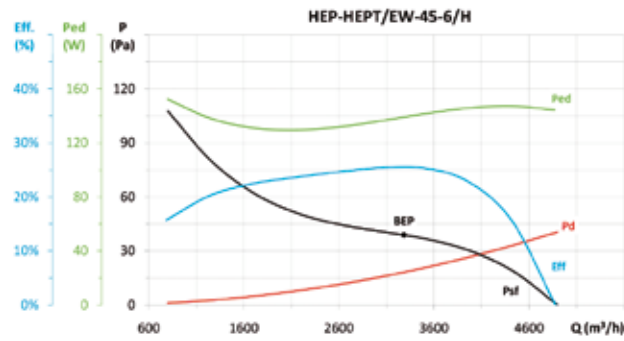

MC	EC	SR	Cc	η_b (%)*	N	[kW]	[m³/h]	[Pa]	[rpm]	VSD
A	S	1,00	1,15	29,3%	41,0	0,139	3284	38,9	960	INCLUDED

* η_e (%) = EFF. (%) x Cc

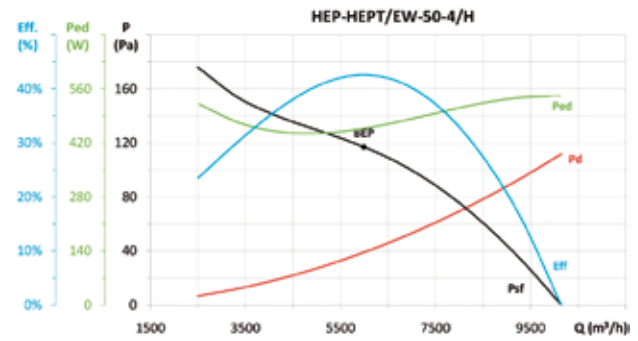

MC	EC	SR	Cc	η_b (%)*	N	[kW]	[m³/h]	[Pa]	[rpm]	VSD
A	S	1,00	1,11	47,3%	55,8	0,457	5994	117,0	1410	INCLUDED

* η_e (%) = EFF. (%) x Cc

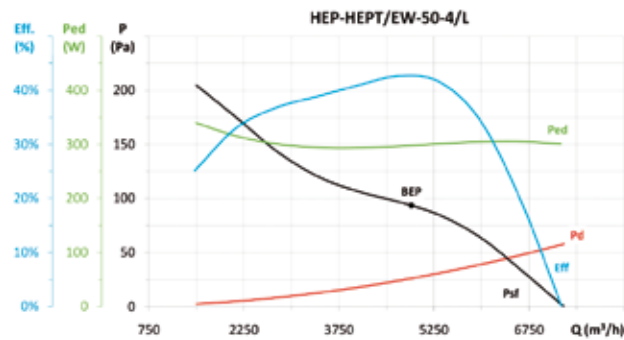

MC	EC	SR	Cc	η_b (%)*	N	[kW]	[m³/h]	[Pa]	[rpm]	VSD
A	S	1,00	1,12	48,0%	57,7	0,298	4894	93,6	1410	INCLUDED

* η_e (%) = EFF. (%) x Cc

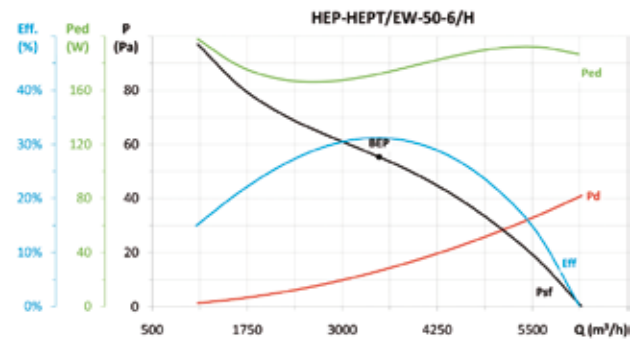

MC	EC	SR	Cc	η_b (%)*	N	[kW]	[m³/h]	[Pa]	[rpm]	VSD
A	S	1,00	1,14	35,5%	46,7	0,172	3484	55,4	960	INCLUDED

* η_e (%) = EFF. (%) x Cc

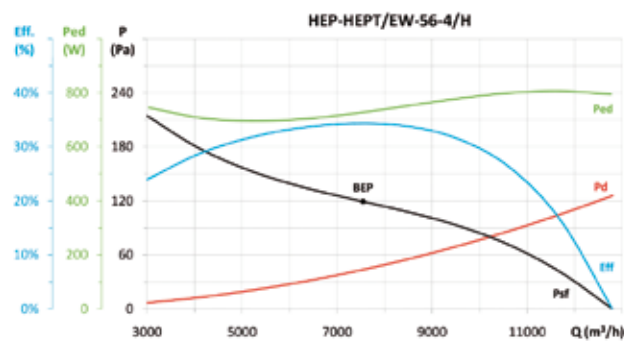

MC	EC	SR	Cc	η_b (%)*	N	[kW]	[m³/h]	[Pa]	[rpm]	VSD
A	S	1,00	1,10	37,7%	44,9	0,728	7546	119,3	1410	INCLUDED

* η_e (%) = EFF. (%) x Cc

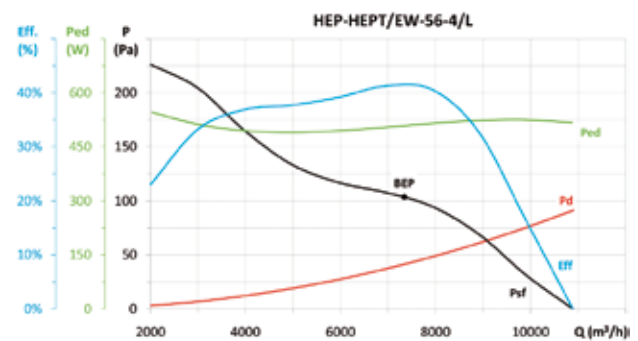

MC	EC	SR	Cc	η_b (%)*	N	[kW]	[m³/h]	[Pa]	[rpm]	VSD
A	S	1,00	1,11	46,0%	54,2	0,509	7344	103,7	1410	INCLUDED

* η_e (%) = EFF. (%) x Cc



Erp. Curvas características y datos ErP.

Modelos HEP/EW - HEPT/EW

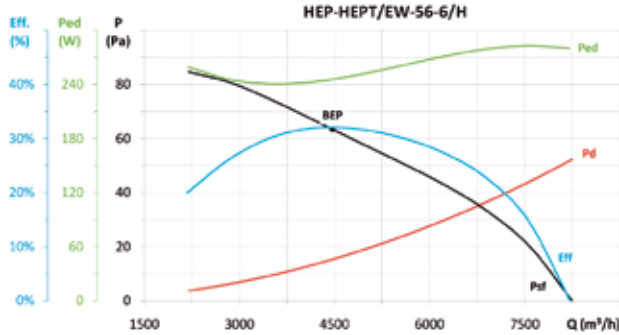

MC	EC	SR	Cc	η_e (%)*	N	[kW]	[m³/h]	[Pa]	[rpm]	VSD
A	S	1,00	1,13	36,2%	46,4	0,245	4469	63,4	960	INCLUDED

* η_e (%) = Eff. (%) x Cc

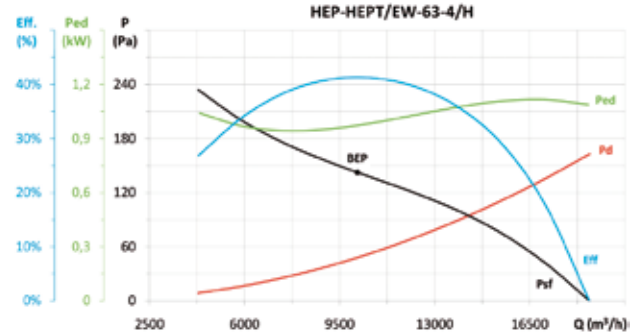

MC	EC	SR	Cc	η_e (%)*	N	[kW]	[m³/h]	[Pa]	[rpm]	VSD
A	S	1,00	1,09	44,9%	51,3	0,973	10152	142,4	1410	INCLUDED

* η_e (%) = Eff. (%) x Cc

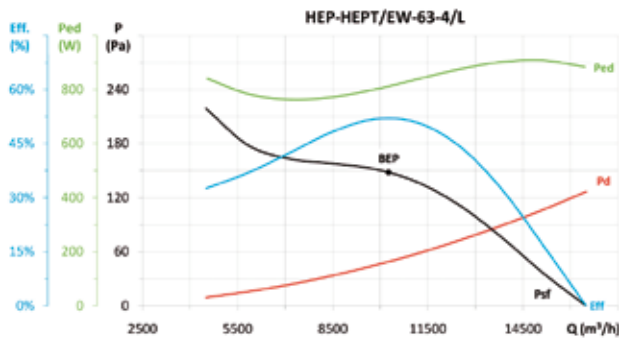

MC	EC	SR	Cc	η_e (%)*	N	[kW]	[m³/h]	[Pa]	[rpm]	VSD
A	S	1,00	1,09	56,9%	63,8	0,812	10263	148,1	1410	INCLUDED

* η_e (%) = Eff. (%) x Cc

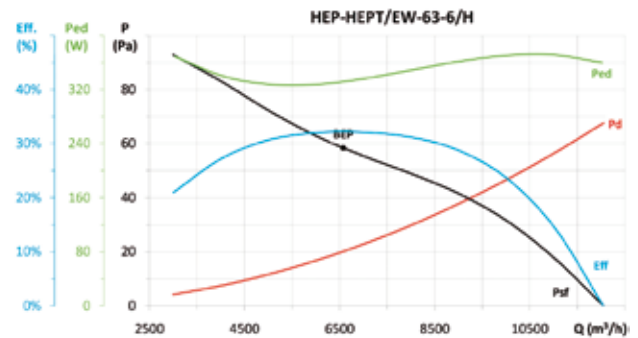

MC	EC	SR	Cc	η_e (%)*	N	[kW]	[m³/h]	[Pa]	[rpm]	VSD
A	S	1,00	1,12	36,0%	45,4	0,332	6577	58,4	960	INCLUDED

* η_e (%) = Eff. (%) x Cc



EFFICIENT WORK



HC/EW



MOTORES TRIFÁSICOS DE ALTA Eficiencia IE3

Ventiladores helicoidales murales, equipados con motor asíncrono de alta eficiencia IE3 regulable electrónicamente.

Hélice de plástico reforzada en fibra de vidrio.

Ventilador:

- Dirección aire motor-hélice.
- Hélice en poliamida 6 reforzada con fibra de vidrio.
- Marco soporte en chapa de acero.
- Como accesorio, rejilla de protección contra contactos según norma UNE 100250.

Motor y variador electrónico :

- Motores eficiencia IE3, regulables electrónicamente.
- Se suministrará el variador de velocidad VSD según pedido.
- Variador electrónico de velocidad (VSD) regulable mediante señal externa de 0-10 V.
- Se recomienda instalar filtros senoidales entre ventilador y variador electrónico de velocidad (VSD), cuando haya gran distancia entre ellos.
- Se recomienda instalar el variador electrónico de velocidad (VSD) fuera de la zona de trabajo.
- La señal externa puede subministrarse a través de un control manual o automático con salida 0-10 V.
- Variador electrónico de velocidad (VSD), disponibles con entrada monofásica 220-240 V 50/60 Hz hasta 3cv (Tipo VSD1/A-RFM) o con entrada trifásica 380-415 V 50/60 Hz (Tipo VSD3/A-RFT).

- Por defecto se entrega el variador electrónico de velocidad (VSD) programado a velocidad constante.
- Temperatura de trabajo ventilador: -25 °C +60 °C.
- Temperatura de trabajo (VSD): -25 °C +50 °C.
- Motores clase F, con rodamientos a bolas, protección IP55.
- Trifásicos 230/400 V 50 Hz. (hasta 5,5 CV) y 400/690 V 50 Hz. (potencias superiores a 5,5 CV).

Acabado:

- Anticorrosivo en resina de poliéster polimerizada a 190 °C, previo desengrase con tratamiento nanotecnológico libre de fosfatos.

Bajo demanda:

- Conjunto motor, hélice y rejilla (versión F).
- Conjunto motor, hélice y rejilla (versión G).
- Dirección aire hélice-motor.



VARIADOR VELOCIDAD
VSD: Variador electrónico de velocidad.
• VSD1/A-RFM
• VSD3/A-RFT
Suministro según pedido

CONTROL
Suministro como accesorio opcional

ALIMENTACIÓN
VSD1/A-RFM:
220-240 V 50/60 Hz
VSD3/A-RFT:
380-415 V 50/60 Hz

Código de pedido del ventilador

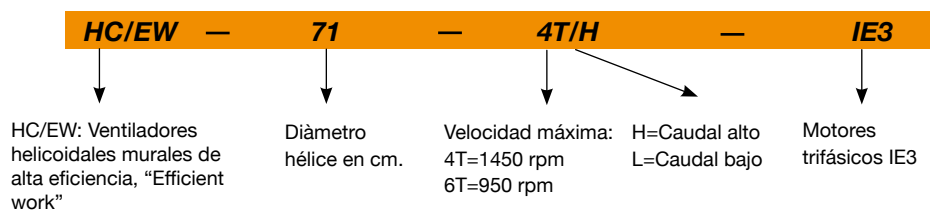

Código de pedido con suministro de variador electrónico (VSD) incluido

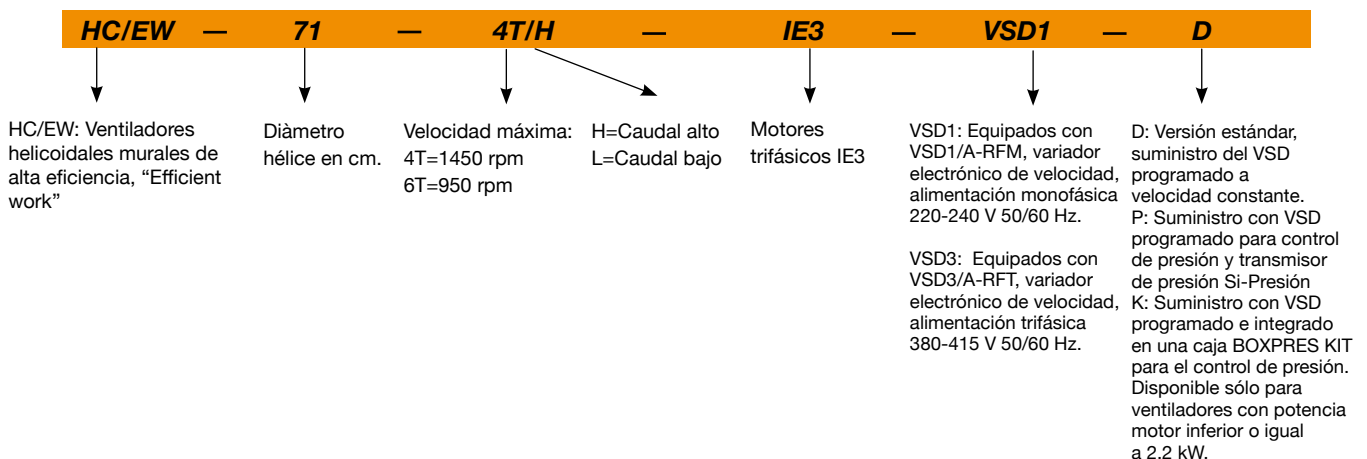



Características técnicas

Modelo	Velocidad min/max (r/min)	VSD monofásico 230 V 50/60 Hz		VSD trifásico 400 V 50/60 Hz		Intensidad máxima Motor 50 Hz			Potencia instalada (kW)	Caudal máximo min/max (m³/h)	Nivel presión sonora min/max dB(A)	Peso aprox. (Kg)
		Intensidad máxima entrada (A)	Modelo VSD	Intensidad máxima entrada (A)	Modelo VSD	230V (A)	400V (A)	690V (A)				
HC/EW-71-4T/H	575/1440	15,78	VSD1/A-RFM-2	4,38	VSD3/A-RFT-2	5,41	3,11	-	1,50	8905 / 22300	58 / 78	35
HC/EW-71-6T/H	375/940	8,69	VSD1/A-RFM-1	2,41	VSD3/A-RFT-1	3,36	1,93	-	0,75	6980 / 17500	46 / 66	36
HC/EW-80-4T/H	575/1440	-	-	7,20	VSD3/A-RFT-5.5	10,70	6,15	-	3,00	13175 / 33000	62 / 82	55
HC/EW-80-4T/L	575/1440	15,78	VSD1/A-RFM-2	4,38	VSD3/A-RFT-2	5,41	3,11	-	1,50	9985 / 25000	59 / 79	44
HC/EW-80-6T/H	375/940	8,69	VSD1/A-RFM-1	2,41	VSD3/A-RFT-1	3,36	1,93	-	0,75	8775 / 22000	51 / 71	45
HC/EW-80-6T/L	370/925	6,90	VSD1/A-RFM-1	1,92	VSD3/A-RFT-1	2,52	1,45	-	0,55	7680 / 19200	50 / 70	39
HC/EW-90-4T/H	580/1450	-	-	9,48	VSD3/A-RFT-5.5	13,90	8,00	-	4,00	17400 / 43500	66 / 86	68
HC/EW-90-4T/L	575/1440	-	-	7,20	VSD3/A-RFT-5.5	10,70	6,15	-	3,00	13495 / 33800	63 / 83	63
HC/EW-90-6T/H	380/950	16,64	VSD1/A-RFM-2	4,62	VSD3/A-RFT-2	6,43	3,70	-	1,50	13320 / 33300	56 / 76	60
HC/EW-90-6T/L	380/945	12,43	VSD1/A-RFM-2	3,45	VSD3/A-RFT-2	4,68	2,69	-	1,10	10535 / 26200	53 / 73	55
HC/EW-100-4T/H	585/1465	-	-	12,81	VSD3/A-RFT-7.5	-	10,30	5,97	5,50	21565 / 54000	68 / 88	85
HC/EW-100-4T/L	580/1450	-	-	9,48	VSD3/A-RFT-5.5	13,90	8,00	-	4,00	17000 / 42500	64 / 84	71
HC/EW-100-6T/H	380/950	16,64	VSD1/A-RFM-2	4,62	VSD3/A-RFT-2	6,43	3,70	-	1,50	14800 / 37000	58 / 78	63
HC/EW-100-6T/L	380/945	12,43	VSD1/A-RFM-2	3,45	VSD3/A-RFT-2	4,68	2,69	-	1,10	11300 / 28100	56 / 76	73

Características acústicas a velocidad máxima

Los valores indicados se determinan mediante medidas de potencia sonora en dB(A) obtenidas en campo libre a una distancia equivalente a dos veces la envergadura del ventilador más el diámetro de la turbina, con un mínimo de 1,5m.

Espectro de potencia sonora Lw(A) en dB(A) banda de frecuencia en [Hz]

Modelo	63	125	250	500	1000	2000	4000	8000	Modelo	63	125	250	500	1000	2000	4000	8000
HC/EW-71-4T/H	47	64	77	84	89	90	85	78	HC/EW-90-4T/L	54	75	82	87	90	86	79	68
HC/EW-71-6T/H	35	52	65	72	77	78	73	66	HC/EW-90-6T/H	61	82	89	94	97	93	86	75
HC/EW-80-4T/H	60	81	88	93	96	92	85	74	HC/EW-90-6T/L	51	72	79	84	87	83	76	85
HC/EW-80-4T/L	49	70	77	82	85	81	74	63	HC/EW-100-4T/H	68	88	96	101	103	100	93	82
HC/EW-80-6T/H	57	78	85	90	93	89	82	71	HC/EW-100-4T/L	58	78	86	91	93	90	83	72
HC/EW-80-6T/L	48	69	76	81	84	80	73	62	HC/EW-100-6T/H	64	84	92	97	99	96	89	78
HC/EW-90-4T/H	64	85	92	97	100	96	89	78	HC/EW-100-6T/L	56	76	84	89	91	88	81	70

Dimensiones mm

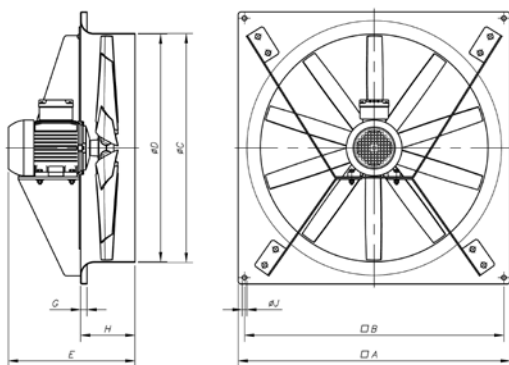

Modelo	∅A	∅B	∅C	∅D	E	G	H	∅J
HC/EW-71-4T/H	850	810	715	711	395	20	170	14,5
HC/EW-71-6T/H	850	810	715	711	395	20	170	14,5
HC/EW-80-4T/H	970	910	801	797	488	20	210	14,5
HC/EW-80-4T/L	970	910	801	797	458	20	210	14,5
HC/EW-80-6T/H	970	910	801	797	458	20	210	14,5
HC/EW-80-6T/L	970	910	801	797	416	20	210	14,5
HC/EW-90-4T/H	1170	1110	918	914	511	20	210	14,5
HC/EW-90-4T/L	1170	1110	918	914	488	20	210	14,5
HC/EW-90-6T/H	1170	1110	918	914	488	20	210	14,5
HC/EW-90-6T/L	1170	1110	918	914	455	20	210	14,5
HC/EW-100-4T/H	1170	1110	1003	999	548	20	220	14,5
HC/EW-100-4T/L	1170	1110	1003	999	521	20	220	14,5
HC/EW-100-6T/H	1170	1110	1003	999	498	20	220	14,5
HC/EW-100-6T/L	1170	1110	1003	999	468	20	220	14,5



EFFICIENT WORK



Erp. Curvas características y datos ErP

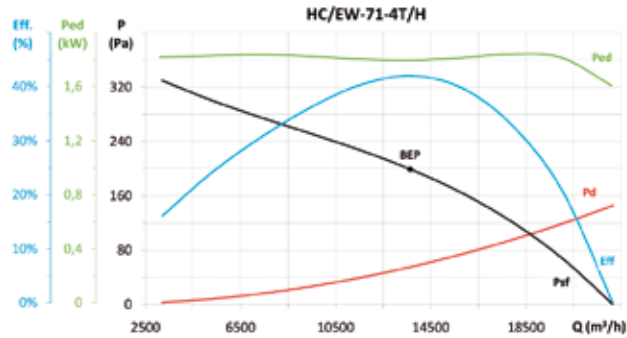

MC	EC	SR	Cc	η_e (%)*	N	[kW]	[m³/h]	[Pa]	[rpm]	VSD
C	S	1,00	1,07	44,9%	49,6	1,796	13627	199,3	1441	NECESSARY

* η_e (%) = Eff. (%) x Cc

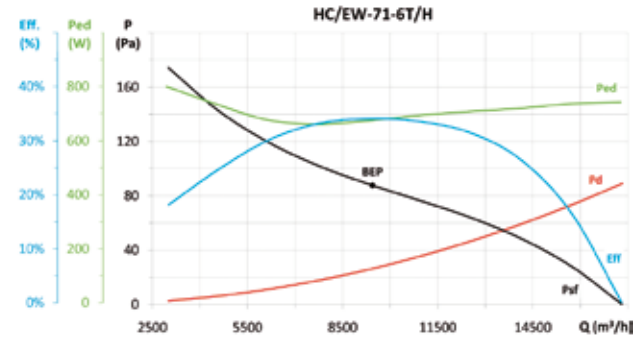

MC	EC	SR	Cc	η_e (%)*	N	[kW]	[m³/h]	[Pa]	[rpm]	VSD
C	S	1,00	1,10	37,4%	44,8	0,675	9443	87,7	959	NECESSARY

* η_e (%) = Eff. (%) x Cc

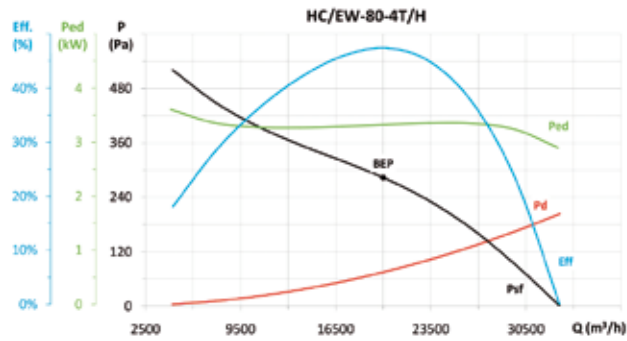

MC	EC	SR	Cc	η_e (%)*	N	[kW]	[m³/h]	[Pa]	[rpm]	VSD
C	S	1,00	1,05	49,8%	52,9	3,321	19996	283,5	1444	NECESSARY

* η_e (%) = Eff. (%) x Cc

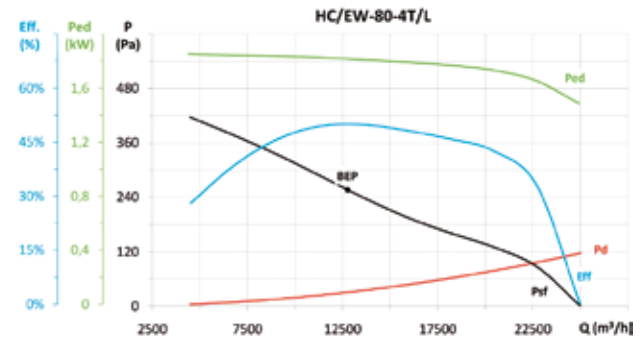

MC	EC	SR	Cc	η_e (%)*	N	[kW]	[m³/h]	[Pa]	[rpm]	VSD
C	S	1,00	1,07	53,5%	58,2	1,818	12760	256,6	1440	NECESSARY

* η_e (%) = Eff. (%) x Cc

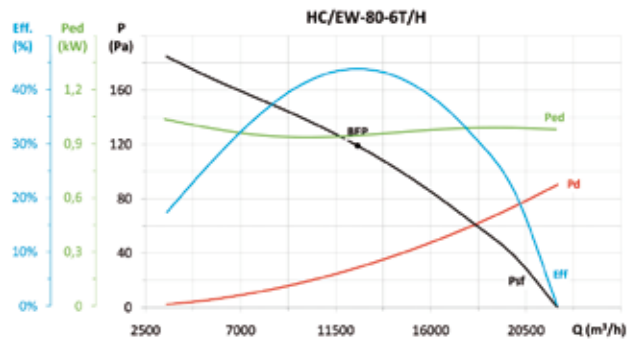

MC	EC	SR	Cc	η_e (%)*	N	[kW]	[m³/h]	[Pa]	[rpm]	VSD
C	S	1,00	1,09	47,7%	54,2	0,945	12533	119,1	943	NECESSARY

* η_e (%) = Eff. (%) x Cc

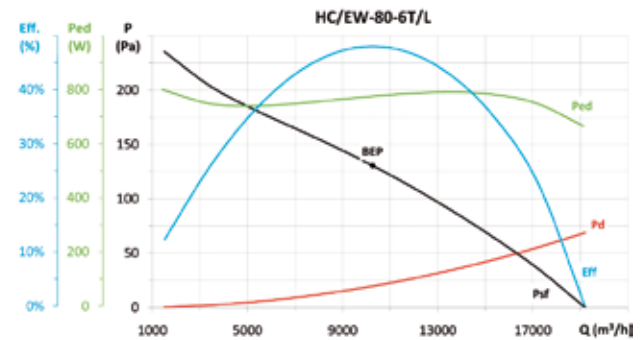

MC	EC	SR	Cc	η_e (%)*	N	[kW]	[m³/h]	[Pa]	[rpm]	VSD
C	S	1,00	1,10	52,6%	59,6	0,775	10262	130,5	927	NECESSARY

* η_e (%) = Eff. (%) x Cc

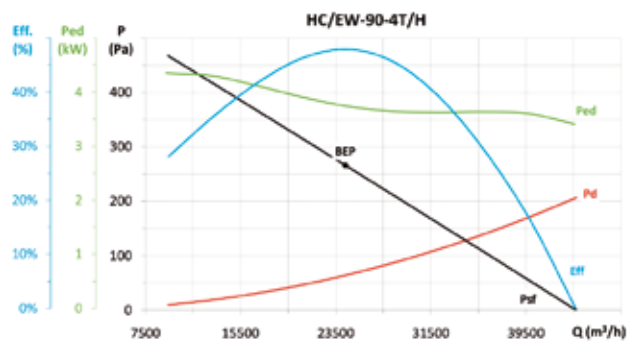

MC	EC	SR	Cc	η_e (%)*	N	[kW]	[m³/h]	[Pa]	[rpm]	VSD
C	S	1,00	1,05	50,2%	52,9	3,751	24299	266,4	1460	NECESSARY

* η_e (%) = Eff. (%) x Cc

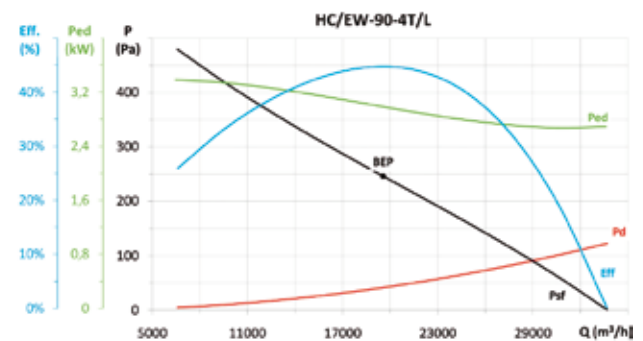

MC	EC	SR	Cc	η_e (%)*	N	[kW]	[m³/h]	[Pa]	[rpm]	VSD
C	S	1,00	1,06	47,2%	50,5	2,989	19552	246,3	1450	NECESSARY

* η_e (%) = Eff. (%) x Cc



Erp. Curvas características y datos ErP

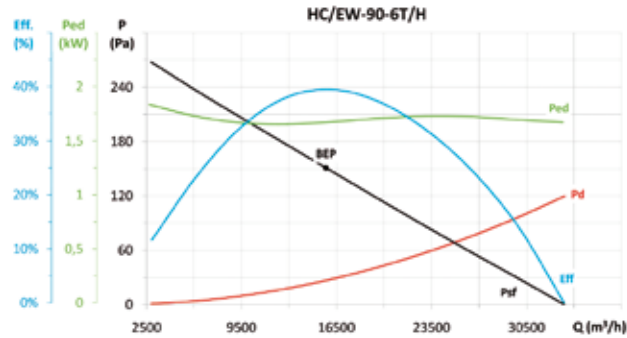

MC	EC	SR	Cc	η_e (%)*	N	[kW]	[m ³ /h]	[Pa]	[rpm]	VSD
C	S	1,00	1,07	42,3%	47,2	1,670	15731	150,9	956	NECESSARY

* η_e (%) = Eff. (%) x Cc

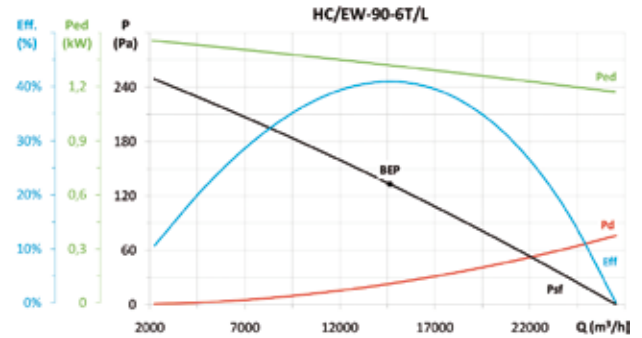

MC	EC	SR	Cc	η_e (%)*	N	[kW]	[m ³ /h]	[Pa]	[rpm]	VSD
C	S	1,00	1,08	44,1%	49,7	1,320	14635	132,9	949	NECESSARY

* η_e (%) = Eff. (%) x Cc

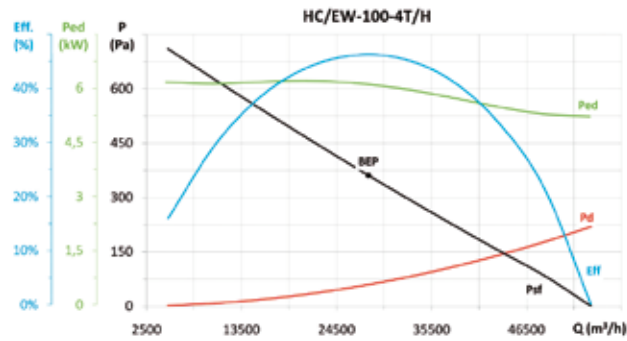

MC	EC	SR	Cc	η_e (%)*	N	[kW]	[m ³ /h]	[Pa]	[rpm]	VSD
C	S	1,00	1,04	48,0%	49,4	6,119	28190	361,3	1466	NECESSARY

* η_e (%) = Eff. (%) x Cc

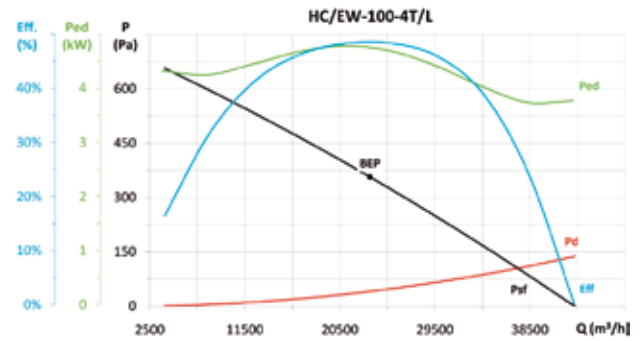

MC	EC	SR	Cc	η_e (%)*	N	[kW]	[m ³ /h]	[Pa]	[rpm]	VSD
C	S	1,00	1,04	50,5%	52,6	4,763	23348	356,7	1450	NECESSARY

* η_e (%) = Eff. (%) x Cc

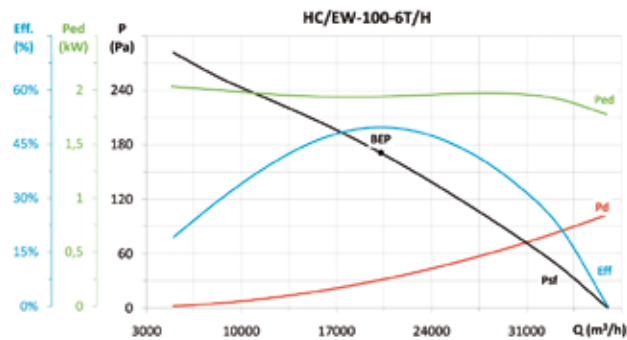

MC	EC	SR	Cc	η_e (%)*	N	[kW]	[m ³ /h]	[Pa]	[rpm]	VSD
C	S	1,00	1,07	53,0%	57,5	1,940	20265	171,1	949	NECESSARY

* η_e (%) = Eff. (%) x Cc

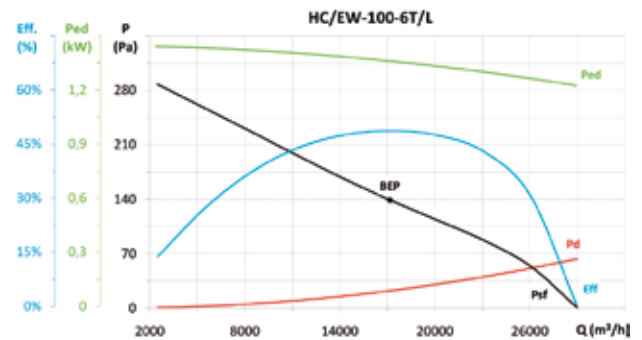

MC	EC	SR	Cc	η_e (%)*	N	[kW]	[m ³ /h]	[Pa]	[rpm]	VSD
C	S	1,00	1,08	52,4%	57,9	1,362	17161	139,0	948	NECESSARY

* η_e (%) = Eff. (%) x Cc

Accesorios

Ver apartado accesorios.



INT



VSD1/A-RFM
VSD3/A-RFT



AET



PL



P



R



RI



S



UNIDADES DE CONTROL Y SENSORES

HCH-HCT-HFT/EW



MOTORES TRIFÁSICOS DE ALTA Eficiencia IE3



VARIADOR VELOCIDAD
VSD: Variador electrónico de velocidad.
· VSD1/A-RFM
· VSD3/A-RFT
Suministro según pedido

CONTROL
Suministro como accesorio opcional

ALIMENTACIÓN
VSD1/A-RFM:
220-240 V 50/60 Hz
VSD3/A-RFT:
380-415 V 50/60 Hz

Ventiladores helicoidales murales o tubulares, equipados con motor asíncrono de alta eficiencia IE3 regulable electrónicamente.

Ventilador:

- Dirección aire motor-hélice.
- Hélices en versión PL en poliamida 6 reforzada con fibra de vidrio y versión AL en fundición de aluminio.
- HCH: Aro soporte mural en chapa de acero con una sola brida.
- HFT: Carcasa corta en chapa de acero con doble brida y prensaestopas para entrada cable.
- HCT: Carcasa larga tubular en chapa de acero con caja de bornes exterior.

Motor y variador electrónico :

- Motores eficiencia IE3, regulables electrónicamente.
- Se suministrará el variador de velocidad VSD según pedido.
- Variador electrónico de velocidad (VSD) regulable mediante señal externa de 0-10 V.
- Se recomienda instalar el variador electrónico de velocidad (VSD) fuera de la zona de trabajo.
- La señal externa puede subministrarse a través de un control manual o automático con salida 0-10 V.
- Se recomienda instalar filtros senoidales entre ventilador y variador electrónico de velocidad (VSD), cuando haya gran distancia entre ellos.
- Variador electrónico de velocidad (VSD), disponibles con entrada monofásica 220-240 V 50/60 Hz hasta 3cv (Tipo VSD1/A-RFM) o con entrada trifásica 380-415 V 50/60 Hz (Tipo VSD3/A-RFT).

- Por defecto se entrega el variador electrónico de velocidad (VSD) programado a velocidad constante.
- Temperatura de trabajo ventilador: -25 °C +60 °C.
- Temperatura de trabajo (VSD): -25 °C +50 °C.
- Motores clase F, con rodamientos a bolas, protección IP55.
- Trifásicos 230/400 V 50 Hz (hasta 5,5 CV) y 400/690 V 50 Hz.(potencias superiores a 5,5 CV)

Acabado:

- Anticorrosivo en resina de poliéster polimerizada a 190 °C, previo desengrase con tratamiento nanotecnológico libre de fosfatos.

Bajo demanda:

- Dirección aire hélice-motor
- Hélices reversible 100%

Código de pedido del ventilador

HCH/EW — 71 — 4T — 1.5 / AL — IE3

HCH/EW: Ventiladores helicoidales murales de alta eficiencia, "Efficient work"

Diámetro hélice en cm.

Velocidad máxima:
4T=1450 rpm
6T=950 rpm

Potencia motor en CV

AL: Hélice de aluminio
PL: Hélice de plástico

Motores trifásicos IE3

HFT/EW: Ventiladores helicoidales con doble brida de alta eficiencia, "Efficient work"

HCT/EW: Ventiladores helicoidales tubulares de alta eficiencia, "Efficient work"

Código de pedido con suministro de variador electrónico (VSD) incluido

HCH/EW — 71 — 4T — 1.5 / AL — IE3 — VSD1 — D

HCH/EW: Ventiladores helicoidales murales de alta eficiencia, "Efficient work"

Diámetro hélice en cm.

Velocidad máxima:
4T=1450 rpm
6T=950 rpm

Potencia motor en CV
AL: Hélice de aluminio
PL: Hélice de plástico

Motores trifásicos IE3

VSD1: Equipados con VSD1/A-RFM, variador electrónico de velocidad, alimentación monofásica 220-240 V 50/60 Hz.

VSD3: Equipados con VSD3/A-RFT, variador electrónico de velocidad, alimentación trifásica 380-415 V 50/60 Hz.

D: Versión estándar, suministro del VSD programado a velocidad constante.
P: Suministro con VSD programado para control de presión y transmisor de presión Si-Presión
K: Suministro con VSD programado e integrado en una caja BOXPRES KIT para el control de presión. Disponible sólo para ventiladores con potencia motor inferior o igual a 2,2 kW.

Características técnicas

Modelo				Velocidad min/max (r/min)	VSD monofásico 230 V 50/60 Hz		VSD trifásico 400 V 50/60 Hz		Intensidad máxima Motor 50 Hz 230V 400V 690V (A)		Potencia instalada (kW)	Caudal máximo min/max (m³/h)	Nivel presión sonora min/max dB(A)	Peso aprox. (Kg)			
					Intensidad máxima entrada (A)	Modelo VSD	Intensidad máxima entrada (A)	Modelo VSD						HCH	HFT	HCT	
HCH/EW	HFT/EW	HCT/EW	56-4T-0.75	570/1420	6,33	VSD1/A-RFM-1	1,76	VSD3/A-RFT-1	2,17	1,25	-	0,55	4435 / 11050	52 / 72	21	23	33
HCH/EW	HFT/EW	HCT/EW	56-4T-1	570/1420	8,32	VSD1/A-RFM-1	2,31	VSD3/A-RFT-1	2,82	1,62	-	0,75	5200 / 12950	53 / 73	22	24	34
HCH/EW	HFT/EW	HCT/EW	56-4T-1.5	580/1455	11,87	VSD1/A-RFM-2	3,30	VSD3/A-RFT-2	4,07	2,34	-	1,10	5580 / 14000	54 / 74	26	28	37
HCH/EW	HFT/EW	HCT/EW	63-4T-1	570/1420	8,32	VSD1/A-RFM-1	2,31	VSD3/A-RFT-1	2,82	1,62	-	0,75	5680 / 14150	53 / 73	27	29	42
HCH/EW	HFT/EW	HCT/EW	63-4T-1.5	580/1455	11,87	VSD1/A-RFM-2	3,30	VSD3/A-RFT-2	4,07	2,34	-	1,10	6775 / 17000	54 / 74	30	32	45
HCH/EW	HFT/EW	HCT/EW	63-4T-2	575/1440	15,78	VSD1/A-RFM-2	4,38	VSD3/A-RFT-2	5,41	3,11	-	1,50	7545 / 18900	55 / 75	33	35	48
HCH/EW	HFT/EW	HCT/EW	63-4T-3	575/1440	23,15	VSD1/A-RFM-3	6,43	VSD3/A-RFT-3	7,93	4,56	-	2,20	8855 / 22100	56 / 76	41	43	57
HCH/EW	HFT/EW	HCT/EW	71-4T-1.5	580/1455	11,87	VSD1/A-RFM-2	3,30	VSD3/A-RFT-2	4,07	2,34	-	1,10	7935 / 19900	58 / 78	33	35	52
HCH/EW	HFT/EW	HCT/EW	71-4T-2	575/1440	15,78	VSD1/A-RFM-2	4,38	VSD3/A-RFT-2	5,41	3,11	-	1,50	8385 / 21000	59 / 79	36	38	55
HCH/EW	HFT/EW	HCT/EW	71-4T-3	575/1435	23,15	VSD1/A-RFM-3	6,43	VSD3/A-RFT-3	7,93	4,56	-	2,20	9615 / 24000	61 / 81	45	47	64
HCH/EW	HFT/EW	HCT/EW	71-4T-4	575/1440	-	-	7,20	VSD3/A-RFT-5.5	10,70	6,15	-	3,00	11740 / 29400	62 / 82	47	49	66
HCH/EW	HFT/EW	HCT/EW	71-6T-0.75	370/925	6,90	VSD1/A-RFM-1	1,92	VSD3/A-RFT-1	2,52	1,45	-	0,55	6000 / 15000	47 / 67	29	31	49
HCH/EW	HFT/EW	HCT/EW	71-6T-1	375/940	8,69	VSD1/A-RFM-2	2,41	VSD3/A-RFT-1	3,36	1,93	-	0,75	6860 / 17200	48 / 68	36	38	55
HCH/EW	HFT/EW	HCT/EW	71-6T-1.5	380/945	12,43	VSD1/A-RFM-2	3,45	VSD3/A-RFT-2	4,68	2,69	-	1,10	8485 / 21100	49 / 69	38	40	57
HCH/EW	HFT/EW	HCT/EW	80-4T-3	575/1435	23,15	VSD1/A-RFM-3	6,43	VSD3/A-RFT-3	7,93	4,56	-	2,20	11820 / 29500	62 / 82	53	55	72
HCH/EW	HFT/EW	HCT/EW	80-4T-4	575/1440	-	-	7,20	VSD3/A-RFT-5.5	10,70	6,15	-	3,00	14775 / 37000	63 / 83	55	57	74
HCH/EW	HFT/EW	HCT/EW	80-4T-5.5	580/1450	-	-	9,48	VSD3/A-RFT-5.5	13,90	8,00	-	4,00	16200 / 40500	64 / 84	60	62	79
HCH/EW	HFT/EW	HCT/EW	80-6T-1	375/940	8,69	VSD1/A-RFM-2	2,41	VSD3/A-RFT-1	3,36	1,93	-	0,75	9175 / 23000	51 / 71	44	46	64
HCH/EW	HFT/EW	HCT/EW	80-6T-1.5	380/945	12,43	VSD1/A-RFM-2	3,45	VSD3/A-RFT-2	4,68	2,69	-	1,10	10455 / 26000	52 / 72	46	48	66
HCH/EW	HFT/EW	HCT/EW	80-6T-2	380/950	16,64	VSD1/A-RFM-2	4,62	VSD3/A-RFT-2	6,43	3,70	-	1,50	11880 / 29700	53 / 73	52	54	71
HCH/EW	HFT/EW	HCT/EW	80-6T-3	380/950	23,83	VSD1/A-RFM-3	6,62	VSD3/A-RFT-3	9,08	5,22	-	2,20	13400 / 33500	54 / 74	57	59	76
HCH/EW	HFT/EW	HCT/EW	90-4T-4	575/1440	-	-	7,20	VSD3/A-RFT-5.5	10,70	6,15	-	3,00	15970 / 40000	67 / 87	62	66	90
HCH/EW	HFT/EW	HCT/EW	90-4T-5.5	580/1450	-	-	9,48	VSD3/A-RFT-5.5	13,90	8,00	-	4,00	18600 / 46500	69 / 89	67	71	95
HCH/EW	HFT/EW	HCT/EW	90-4T-7.5	585/1465	-	-	12,81	VSD3/A-RFT-7.5	-	10,30	5,97	5,50	20365 / 51000	71 / 91	83	87	109
HCH/EW	HFT/EW	HCT/EW	90-4T-10	585/1465	-	-	17,32	VSD3/A-RFT-10	-	13,90	8,06	7,50	21845 / 54700	72 / 92	94	98	120
HCH/EW	HFT/EW	HCT/EW	90-6T-2	380/950	16,64	VSD1/A-RFM-2	4,62	VSD3/A-RFT-2	6,43	3,70	-	1,50	13720 / 34300	57 / 77	59	63	87
HCH/EW	HFT/EW	HCT/EW	90-6T-3	380/950	23,83	VSD1/A-RFM-3	6,62	VSD3/A-RFT-3	9,08	5,22	-	2,20	15200 / 38000	58 / 78	64	68	92
HCH/EW	HFT/EW	HCT/EW	90-6T-4	390/970	-	-	7,39	VSD3/A-RFT-5.5	12,00	6,91	-	3,00	17045 / 42400	59 / 79	88	92	114
HCH/EW	HFT/EW	HCT/EW	100-4T-7.5	585/1465	-	-	12,81	VSD3/A-RFT-7.5	-	10,30	5,97	5,50	21565 / 54000	72 / 92	91	95	121
HCH/EW	HFT/EW	HCT/EW	100-4T-10	585/1465	-	-	17,32	VSD3/A-RFT-10	-	13,90	8,06	7,50	25155 / 63000	73 / 93	102	106	131
HCH/EW	HFT/EW	HCT/EW	100-4T-15	590/1470	-	-	25,10	VSD3/A-RFT-15	-	21,40	12,40	11,00	27295 / 68000	74 / 94	125	129	160
HCH/EW	HFT/EW	HCT/EW	100-4T-20	585/1465	-	-	34,41	VSD3/A-RFT-20	-	28,70	16,60	15,00	28750 / 72000	75 / 95	144	148	179
HCH/EW	HFT/EW	HCT/EW	100-6T-3	380/950	23,83	VSD1/A-RFM-3	6,62	VSD3/A-RFT-3	9,08	5,22	-	2,20	17200 / 43000	62 / 82	72	76	103
HCH/EW	HFT/EW	HCT/EW	100-6T-4	390/970	-	-	7,39	VSD3/A-RFT-5.5	12,00	6,91	-	3,00	18895 / 47000	63 / 83	96	100	125
HCH/EW	HFT/EW	HCT/EW	100-6T-5.5	385/960	-	-	9,74	VSD3/A-RFT-5.5	15,60	8,99	-	4,00	21255 / 53000	64 / 84	104	108	133

Características acústicas a velocidad máxima

Los valores indicados, se determinan mediante medidas de de nivel de presión y potencia sonora en dB(A) obtenidas en campo libre a una distancia equivalente a dos veces la envergadura del ventilador más el diámetro de la hélice, con un mínimo de 1,5 mts.

Espectro de potencia sonora Lw(A) en dB(A) banda de frecuencia en [Hz]

Modelo	63	125	250	500	1000	2000	4000	8000	Modelo	63	125	250	500	1000	2000	4000	8000
56-4T-0.75	47	67	75	80	82	79	72	61	80-6T-1.5	49	69	77	82	84	81	74	63
56-4T-1	48	68	76	81	83	80	73	62	80-6T-2	50	70	78	83	85	82	75	64
56-4T-1.5	49	69	77	82	84	81	74	63	80-6T-3	51	71	79	84	86	83	76	65
63-4T-1	50	70	78	83	85	82	75	64	90-4T-4	65	86	93	98	101	97	90	79
63-4T-1.5	51	71	79	84	86	83	76	65	90-4T-5.5	67	88	95	100	103	99	92	81
63-4T-2	52	72	80	85	87	84	77	66	90-4T-7.5	69	90	97	102	105	101	94	83
63-4T-3	53	73	81	86	88	85	78	67	90-4T-10	70	91	98	103	106	102	95	84
71-4T-1.5	55	75	83	88	90	87	80	69	90-6T-2	55	76	83	88	91	87	80	69
71-4T-2	56	76	84	89	91	88	81	70	90-6T-3	56	77	84	89	92	88	81	70
71-4T-3	58	78	86	91	93	90	83	72	90-6T-4	57	78	85	90	93	89	82	71
71-4T-4	59	79	87	92	94	91	84	73	100-4T-7.5	72	92	100	105	107	104	97	86
71-6T-0.75	44	64	72	77	79	76	69	58	100-4T-10	73	93	101	106	108	105	98	87
71-6T-1	45	65	73	78	80	77	70	59	100-4T-15	74	94	102	107	109	106	99	88
71-6T-1.5	46	66	74	79	81	78	71	60	100-4T-20	75	95	103	108	110	107	100	89
80-4T-3	59	79	87	92	94	91	84	73	100-6T-3	62	82	90	95	97	94	87	76
80-4T-4	60	80	88	93	95	92	85	74	100-6T-4	63	83	91	96	98	95	88	77
80-4T-5.5	61	81	89	94	96	93	86	75	100-6T-5.5	64	84	92	97	99	96	89	78
80-6T-1	48	68	76	81	83	80	73	62									



EFFICIENT WORK



Dimensiones mm

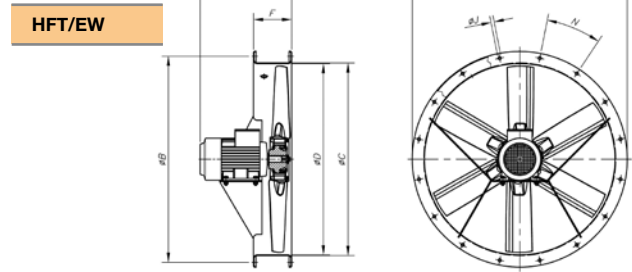
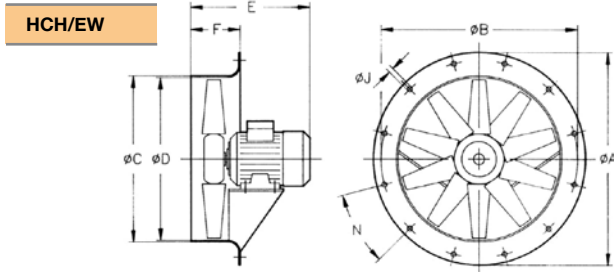

Modelo	ØA	ØB	ØC	ØD	E											F	ØJ	N	
					0,75	1	1,5	2	3	4	5,5	7,5	10	15	20				
HCH/EW-56-4T	660	620	564	560	310	310	330										120	12	12 X 30°
HCH/EW-63-4T	730	690	645	640		325	325	355	405								150	12	12 X 30°
HCH/EW-71-4T	810	770	715	710			330	350	415	415							150	12	16 X 22°30'
HCH/EW-71-6T	810	770	715	710	315	330	350										150	12	16 X 22°30'
HCH/EW-80-4T	900	860	805	800					425	425	445						180	12	16 X 22°30'
HCH/EW-80-6T	900	860	805	800		355	375	425	445								180	12	16 X 22°30'
HCH/EW-90-4T	1015	970	906	900						425	430	465	465				180	15	16 X 22°30'
HCH/EW-90-6T	1015	970	906	900				425	430	465							180	15	16 X 22°30'
HCH/EW-100-4T	1115	1070	1006	1000							480	480	590	590			200	15	16 X 22°30'
HCH/EW-100-6T	1115	1070	1006	1000					440	480	480						200	15	16 X 22°30'
HFT/EW-56-4T	660	620	564	560	344	344	376										120	12	12 X 30°
HFT/EW-56-6T	660	620	564	560													120	12	12 X 30°
HFT/EW-63-4T	730	690	645	640		325	398	398	430	430							120	12	12 X 30°
HFT/EW-63-6T	730	690	645	640	325	398											120	12	12 X 30°
HFT/EW-71-4T	810	770	715	710			400	400	440	440							150	12	16 X 22°30'
HFT/EW-71-6T	810	770	715	710	325	400	400										150	12	16 X 22°30'
HFT/EW-80-4T	900	860	805	800					425	425	445						180	12	16 X 22°30'
HFT/EW-80-6T	900	860	805	800		390	390	425	445								180	12	16 X 22°30'
HFT/EW-90-4T	1015	970	906	900						430	440	470	470				180	15	16 X 22°30'
HFT/EW-90-6T	1015	970	906	900				430	440	470							180	15	16 X 22°30'
HFT/EW-100-4T	1115	1070	1006	1000							485	485	590	590			200	15	16 X 22°30'
HFT/EW-100-6T	1115	1070	1006	1000					440	485	485						200	15	16 X 22°30'

HCT/EW

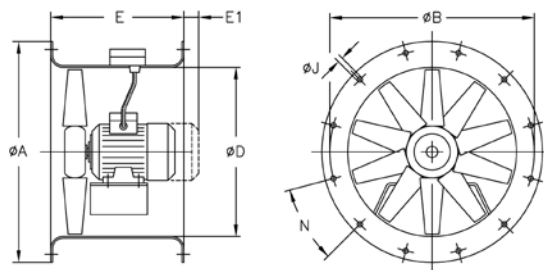

Modelo	ØA	ØB	ØD	E	ØJ	N
HCT/EW-56	660	620	560	400	12	12x30°
HCT/EW-63	730	690	640	430	12	12x30°
HCT/EW-71	810	770	710	500	12	16x22°30'
HCT/EW-80	900	860	800	500	12	16x22°30'
HCT/EW-90	1015	970	900	500	15	16x22°30'
HCT/EW-100	1115	1070	1000	550	15	16x22°30'
HCT/EW-100-4T-15	1115	1070	1000	650	15	16x22°30'
HCT/EW-100-4T-20	1115	1070	1000	650	15	16x22°30'



Erp. Curvas características y datos ErP

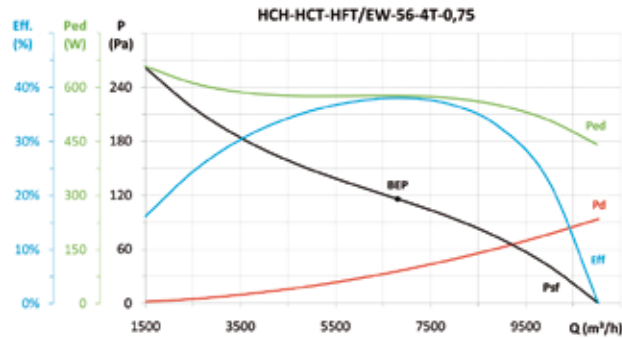

MC	EC	SR	Cc	η_e (%)*	N	[kW]	[m³/h]	[Pa]	[rpm]	VSD
A	S	1,00	1,10	41,9%	49,8	0,577	6808	115,8	1437	NECESSARY

* η_e (%) = Eff. (%) x Cc

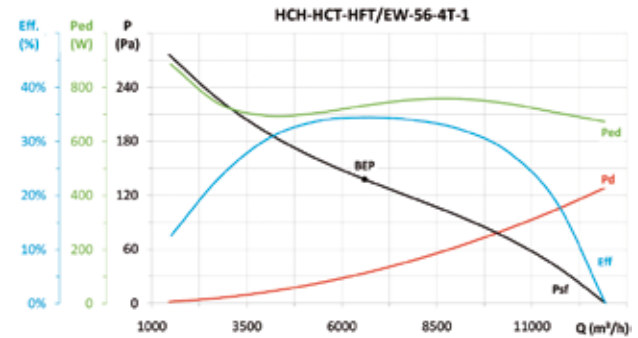

MC	EC	SR	Cc	η_e (%)*	N	[kW]	[m³/h]	[Pa]	[rpm]	VSD
A	S	1,00	1,10	37,8%	45,0	0,732	6599	137,7	1436	NECESSARY

* η_e (%) = Eff. (%) x Cc

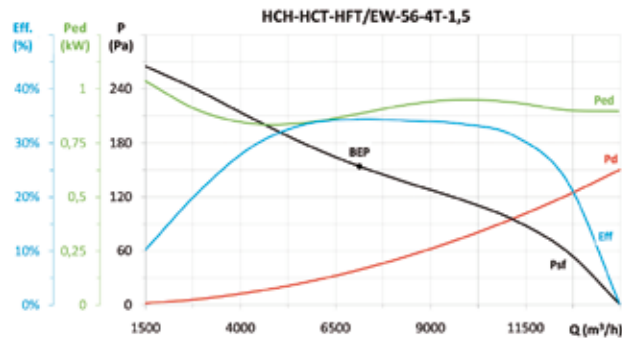

MC	EC	SR	Cc	η_e (%)*	N	[kW]	[m³/h]	[Pa]	[rpm]	VSD
A	S	1,00	1,09	37,5%	44,2	0,886	7130	153,9	1453	NECESSARY

* η_e (%) = Eff. (%) x Cc

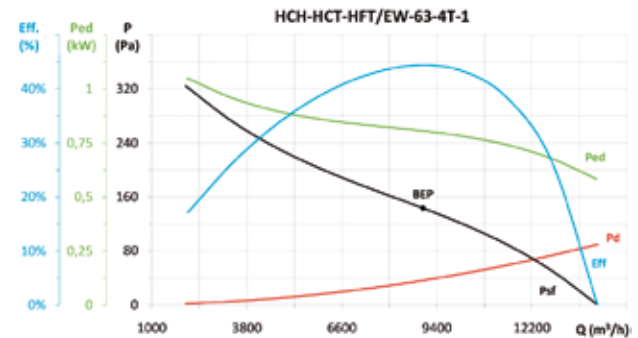

MC	EC	SR	Cc	η_e (%)*	N	[kW]	[m³/h]	[Pa]	[rpm]	VSD
A	S	1,00	1,09	48,5%	55,5	0,806	8989	143,3	1433	NECESSARY

* η_e (%) = Eff. (%) x Cc

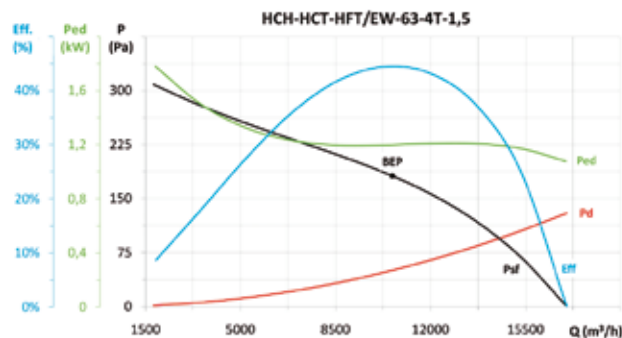

MC	EC	SR	Cc	η_e (%)*	N	[kW]	[m³/h]	[Pa]	[rpm]	VSD
A	S	1,00	1,08	48,1%	54,0	1,200	10593	181,5	1460	NECESSARY

* η_e (%) = Eff. (%) x Cc

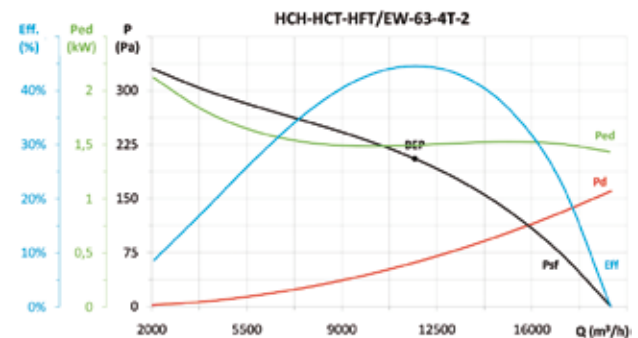

MC	EC	SR	Cc	η_e (%)*	N	[kW]	[m³/h]	[Pa]	[rpm]	VSD
A	S	1,00	1,08	47,9%	53,1	1,496	11688	205,4	1451	NECESSARY

* η_e (%) = Eff. (%) x Cc

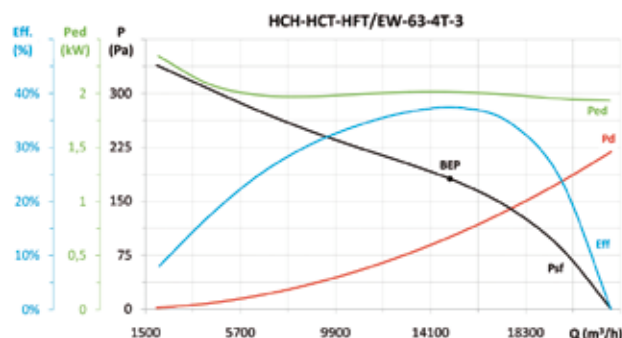

MC	EC	SR	Cc	η_e (%)*	N	[kW]	[m³/h]	[Pa]	[rpm]	VSD
A	S	1,00	1,07	39,8%	44,3	2,014	14963	181,1	1448	NECESSARY

* η_e (%) = Eff. (%) x Cc

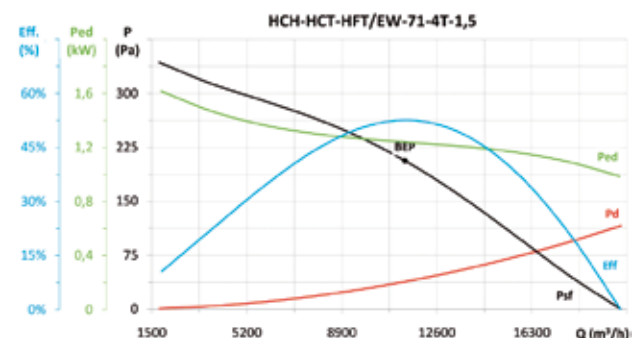

MC	EC	SR	Cc	η_e (%)*	N	[kW]	[m³/h]	[Pa]	[rpm]	VSD
A	S	1,00	1,08	56,8%	62,5	1,239	11355	206,4	1459	NECESSARY

* η_e (%) = Eff. (%) x Cc



EFFICIENT WORK



Erp. Curvas características y datos ErP

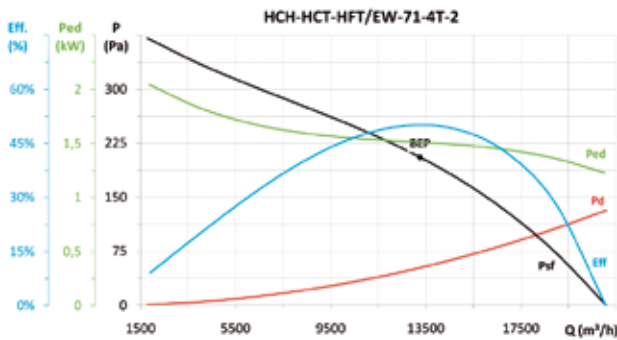

MC	EC	SR	Cc	η_a (%)*	N	[kW]	[m³/h]	[Pa]	[rpm]	VSD
A	S	1,00	1,08	53,8%	59,0	1,511	13256	205,5	1450	NECESSARY

* η_e (%) = Eff. (%) x Cc

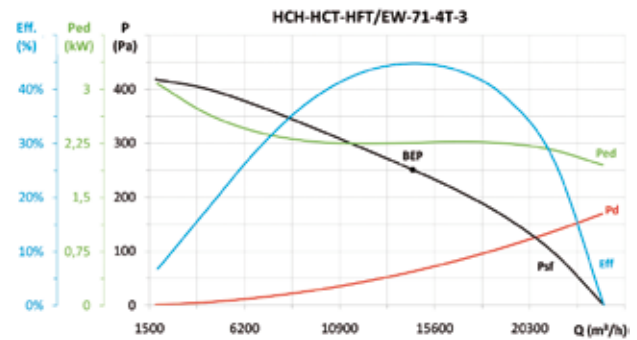

MC	EC	SR	Cc	η_a (%)*	N	[kW]	[m³/h]	[Pa]	[rpm]	VSD
A	S	1,00	1,06	47,6%	51,7	2,260	14513	251,0	1445	NECESSARY

* η_e (%) = Eff. (%) x Cc

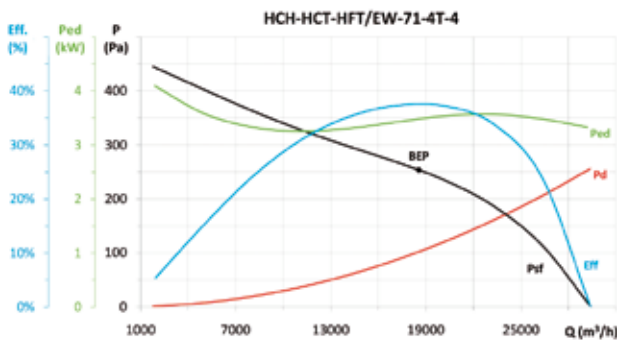

MC	EC	SR	Cc	η_a (%)*	N	[kW]	[m³/h]	[Pa]	[rpm]	VSD
A	S	1,00	1,05	39,4%	42,3	3,482	18556	253,6	1442	NECESSARY

* η_e (%) = Eff. (%) x Cc

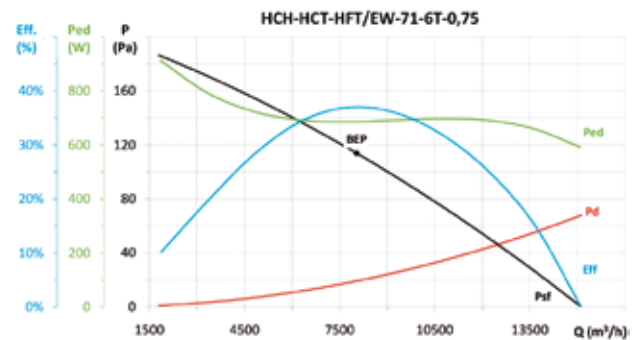

MC	EC	SR	Cc	η_a (%)*	N	[kW]	[m³/h]	[Pa]	[rpm]	VSD
A	S	1,00	1,10	40,7%	48,0	0,686	8036	113,8	935	NECESSARY

* η_e (%) = Eff. (%) x Cc

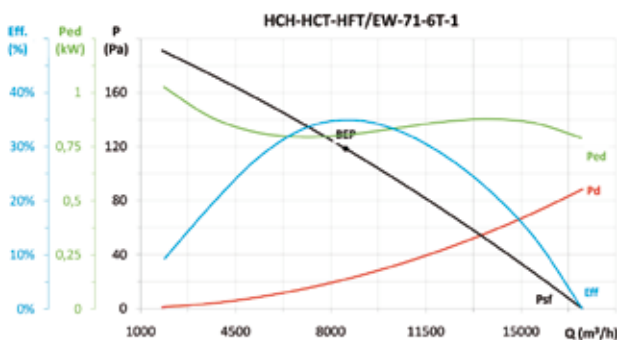

MC	EC	SR	Cc	η_a (%)*	N	[kW]	[m³/h]	[Pa]	[rpm]	VSD
A	S	1,00	1,09	38,2%	45,1	0,805	8550	118,5	952	NECESSARY

* η_e (%) = Eff. (%) x Cc

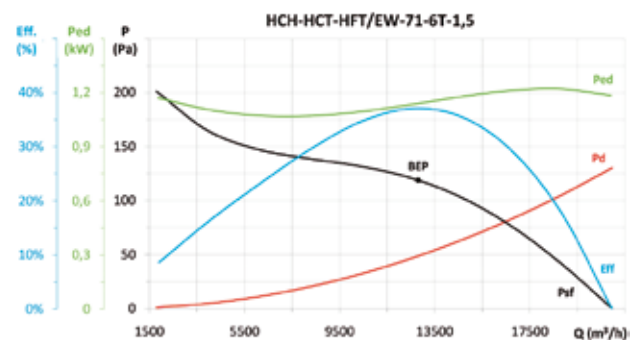

MC	EC	SR	Cc	η_a (%)*	N	[kW]	[m³/h]	[Pa]	[rpm]	VSD
A	S	1,00	1,08	40,2%	46,1	1,140	12806	118,8	956	NECESSARY

* η_e (%) = Eff. (%) x Cc

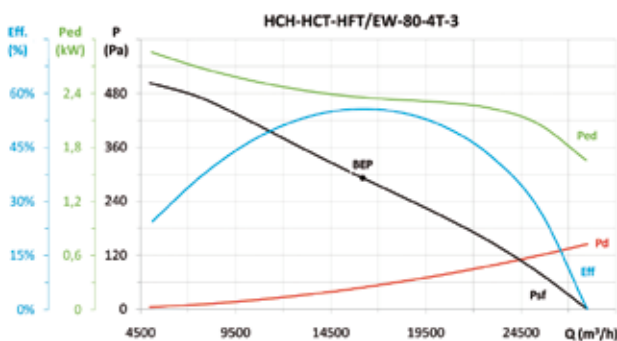

MC	EC	SR	Cc	η_a (%)*	N	[kW]	[m³/h]	[Pa]	[rpm]	VSD
A	S	1,00	1,06	59,1%	63,0	2,355	16178	291,7	1442	NECESSARY

* η_e (%) = Eff. (%) x Cc

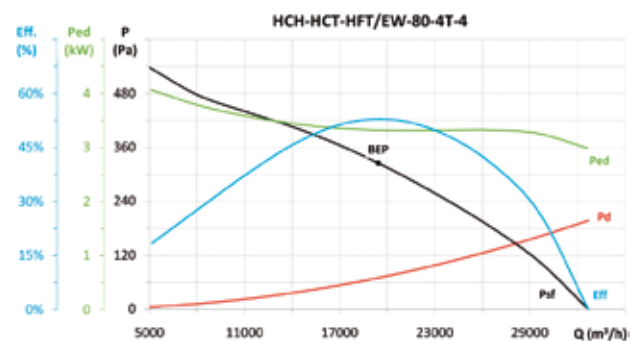

MC	EC	SR	Cc	η_a (%)*	N	[kW]	[m³/h]	[Pa]	[rpm]	VSD
A	S	1,00	1,05	55,5%	58,6	3,319	19442	324,8	1445	NECESSARY

* η_e (%) = Eff. (%) x Cc



Erp. Curvas características y datos ErP

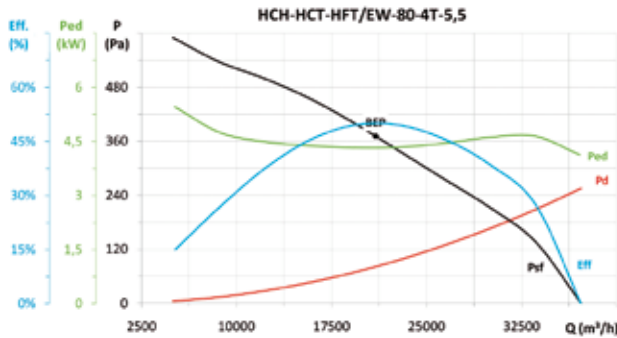

MC	EC	SR	Cc	η_e (%)*	N	[kW]	[m³/h]	[Pa]	[rpm]	VSD
A	S	1,00	1,04	52,2%	54,5	4,324	20980	371,3	1454	NECESSARY

* η_e (%) = Eff. (%) x Cc

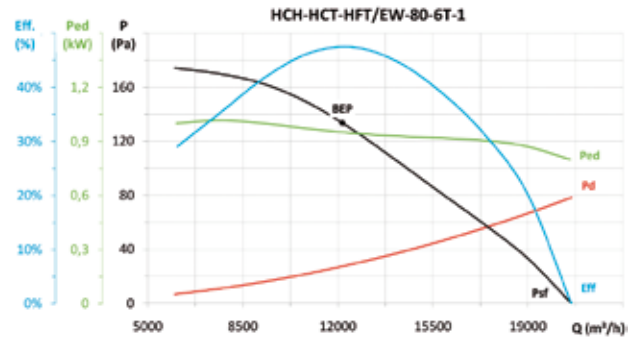

MC	EC	SR	Cc	η_e (%)*	N	[kW]	[m³/h]	[Pa]	[rpm]	VSD
A	S	1,00	1,09	51,7%	58,2	0,950	12168	133,6	943	NECESSARY

* η_e (%) = Eff. (%) x Cc

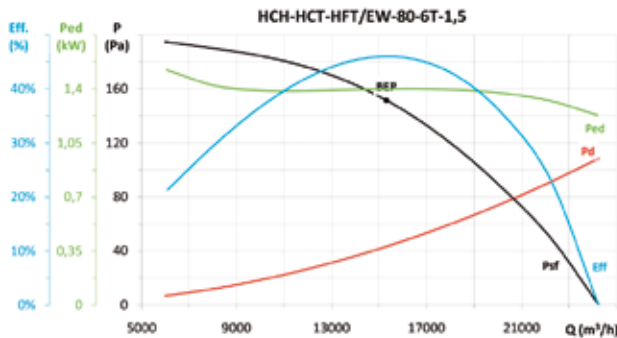

MC	EC	SR	Cc	η_e (%)*	N	[kW]	[m³/h]	[Pa]	[rpm]	VSD
A	S	1,00	1,08	49,6%	55,0	1,400	15312	151,5	946	NECESSARY

* η_e (%) = Eff. (%) x Cc

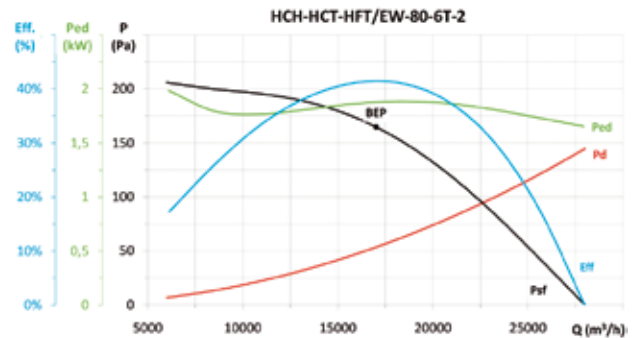

MC	EC	SR	Cc	η_e (%)*	N	[kW]	[m³/h]	[Pa]	[rpm]	VSD
A	S	1,00	1,07	44,3%	48,9	1,878	17013	164,7	951	NECESSARY

* η_e (%) = Eff. (%) x Cc

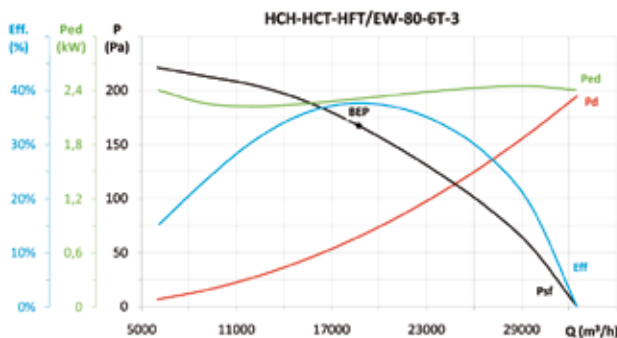

MC	EC	SR	Cc	η_e (%)*	N	[kW]	[m³/h]	[Pa]	[rpm]	VSD
A	S	1,00	1,06	40,0%	44,1	2,310	18724	167,5	955	NECESSARY

* η_e (%) = Eff. (%) x Cc

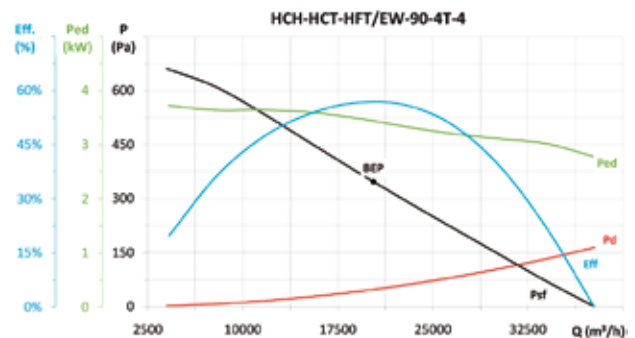

MC	EC	SR	Cc	η_e (%)*	N	[kW]	[m³/h]	[Pa]	[rpm]	VSD
A	S	1,00	1,05	59,7%	62,7	3,438	20308	346,8	1443	NECESSARY

* η_e (%) = Eff. (%) x Cc

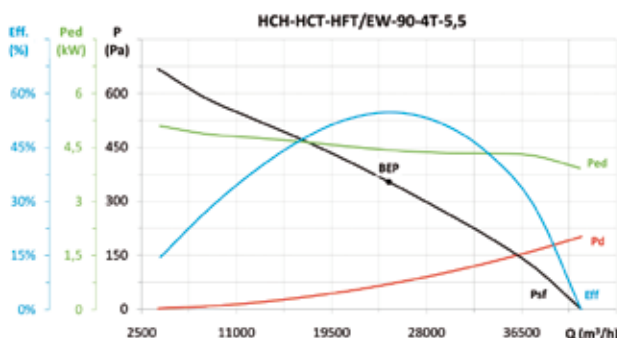

MC	EC	SR	Cc	η_e (%)*	N	[kW]	[m³/h]	[Pa]	[rpm]	VSD
A	S	1,00	1,04	57,0%	59,3	4,425	24635	353,7	1453	NECESSARY

* η_e (%) = Eff. (%) x Cc

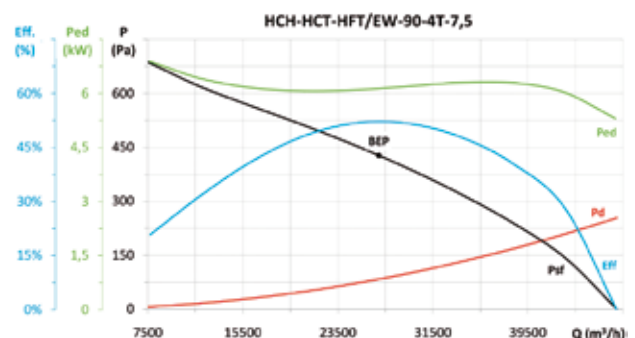

MC	EC	SR	Cc	η_e (%)*	N	[kW]	[m³/h]	[Pa]	[rpm]	VSD
A	S	1,01	1,04	54,2%	55,6	6,132	26945	427,3	1466	NECESSARY

* η_e (%) = Eff. (%) x Cc



EFFICIENT WORK



Erp. Curvas características y datos Erp

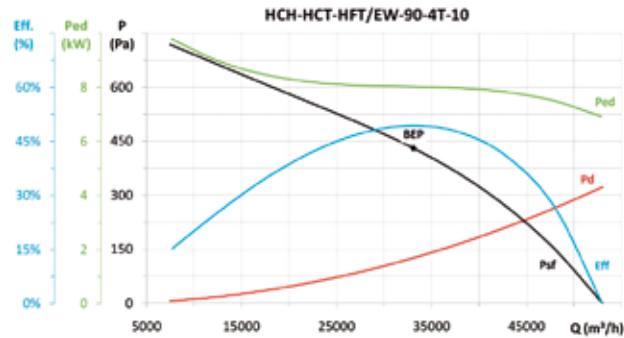

MC	EC	SR	Cc	η_e (%)*	N	[kW]	[m³/h]	[Pa]	[rpm]	VSD
A	S	1,01	1,04	51,3%	51,9	8,025	33102	430,6	1467	NECESSARY

* η_e (%) = Eff. (%) x Cc

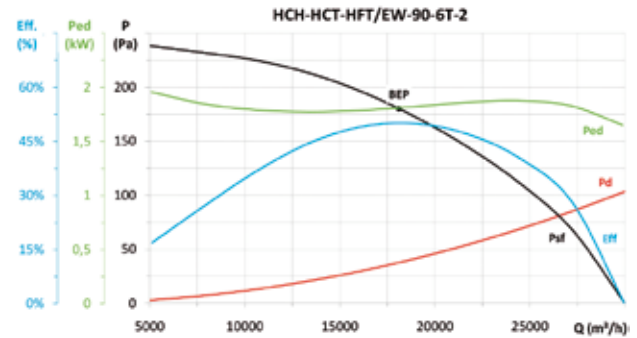

MC	EC	SR	Cc	η_e (%)*	N	[kW]	[m³/h]	[Pa]	[rpm]	VSD
A	S	1,00	1,07	53,5%	58,3	1,810	18106	180,2	953	NECESSARY

* η_e (%) = Eff. (%) x Cc

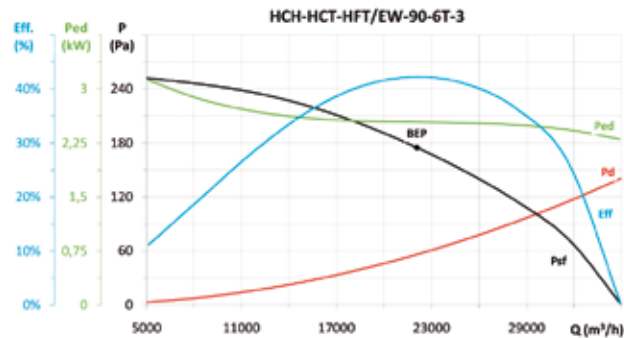

MC	EC	SR	Cc	η_e (%)*	N	[kW]	[m³/h]	[Pa]	[rpm]	VSD
A	S	1,00	1,06	44,7%	48,5	2,539	22079	174,8	954	NECESSARY

* η_e (%) = Eff. (%) x Cc

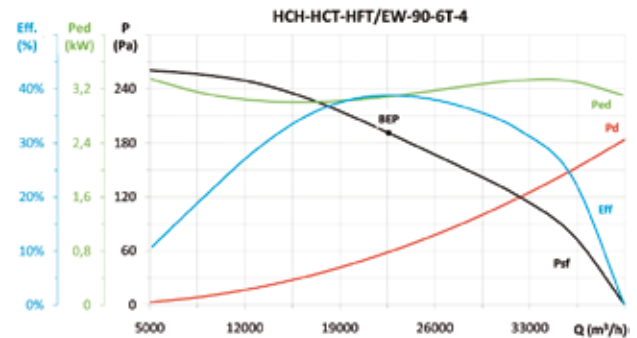

MC	EC	SR	Cc	η_e (%)*	N	[kW]	[m³/h]	[Pa]	[rpm]	VSD
A	S	1,00	1,05	40,9%	44,1	3,087	22590	191,0	974	NECESSARY

* η_e (%) = Eff. (%) x Cc

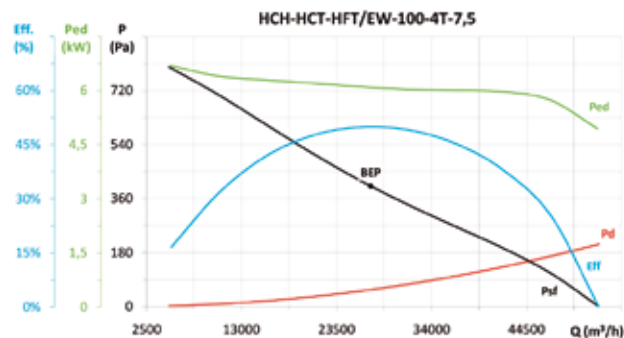

MC	EC	SR	Cc	η_e (%)*	N	[kW]	[m³/h]	[Pa]	[rpm]	VSD
A	S	1,00	1,04	51,9%	53,3	6,092	27281	401,7	1467	NECESSARY

* η_e (%) = Eff. (%) x Cc

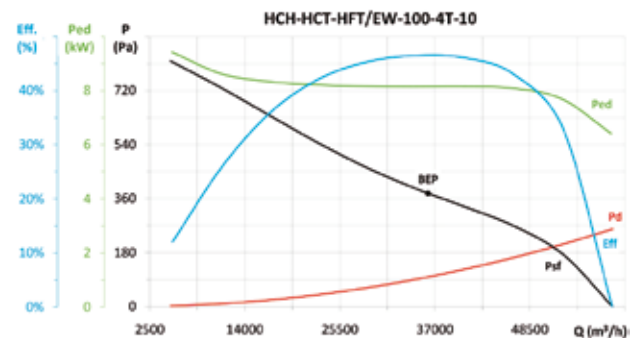

MC	EC	SR	Cc	η_e (%)*	N	[kW]	[m³/h]	[Pa]	[rpm]	VSD
A	S	1,00	1,04	48,4%	49,0	8,145	36164	377,5	1467	NECESSARY

* η_e (%) = Eff. (%) x Cc

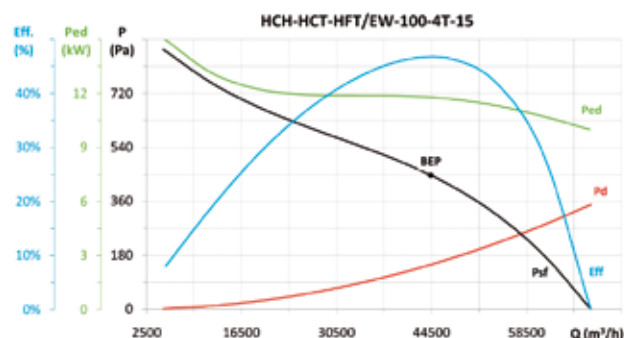

MC	EC	SR	Cc	η_e (%)*	N	[kW]	[m³/h]	[Pa]	[rpm]	VSD
A	S	1,01	1,04	48,6%	48,5	11,781	44388	446,6	1472	NECESSARY

* η_e (%) = Eff. (%) x Cc

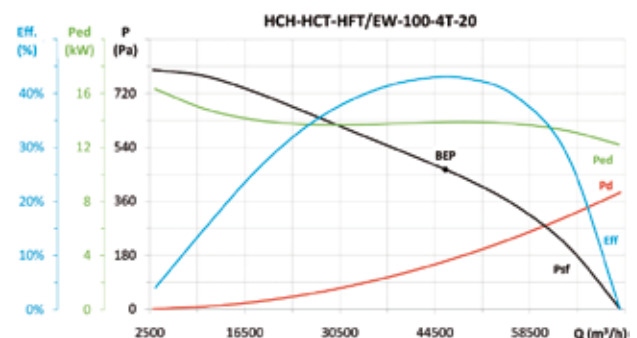

MC	EC	SR	Cc	η_e (%)*	N	[kW]	[m³/h]	[Pa]	[rpm]	VSD
A	S	1,01	1,04	44,7%	44,5	13,862	46050	465,9	1472	NECESSARY

* η_e (%) = Eff. (%) x Cc



Erp. Curvas características y datos ErP

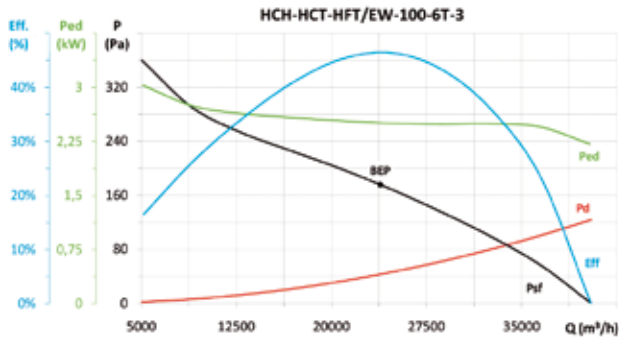

MC	EC	SR	Cc	η_e (%)*	N	[kW]	[m³/h]	[Pa]	[rpm]	VSD
A	S	1,00	1,06	49,2%	53,0	2,508	23849	175,8	954	NECESSARY

* η_e (%) = Eff. (%) x Cc

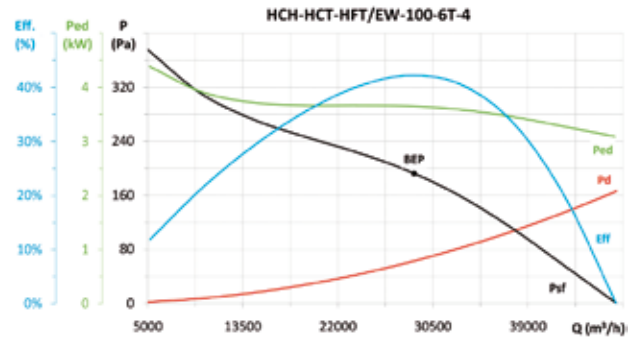

MC	EC	SR	Cc	η_e (%)*	N	[kW]	[m³/h]	[Pa]	[rpm]	VSD
A	S	1,00	1,05	44,2%	47,0	3,650	28826	192,4	970	NECESSARY

* η_e (%) = Eff. (%) x Cc

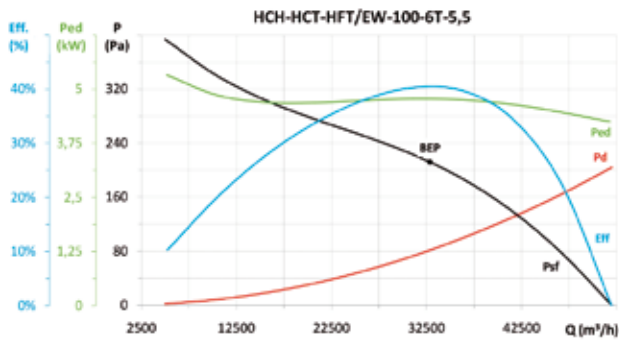

MC	EC	SR	Cc	η_e (%)*	N	[kW]	[m³/h]	[Pa]	[rpm]	VSD
A	S	1,00	1,04	42,1%	44,1	4,780	32856	212,0	961	NECESSARY

* η_e (%) = Eff. (%) x Cc

Accesorios

Ver apartado accesorios.

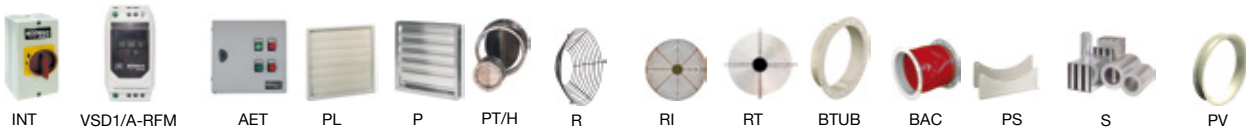



EFFICIENT WORK



CBD/EW CBD/B/EW



MOTOR
BRUSHLESS
INDUSTRIAL E.C.



VARIADOR VELOCIDAD
VSD: Variador electrónico de velocidad.
- VSD1/B
- VSD3/B

Suministro incluido con el ventilador

CONTROL
Suministro como accesorio opcional

ALIMENTACIÓN
VSD1/B:
220-240 V 50/60 Hz
VSD3/B:
380-415 V 50/60 Hz

Ventiladores centrífugos de doble aspiración con motor directo y turbina con álabes hacia delante, de alta eficiencia, equipados con motor Brushless industrial E.C.

Ventilador:

- Envoltente en chapa de acero galvanizado.
- Turbina con álabes hacia delante, en chapa de acero galvanizado.
- Se suministra con pies soporte PSB.
- Variador electrónico de velocidad (VSD), monofásico o trifásico, incluido con el ventilador.

Motor y variador electrónico:

- Motores brushless industriales E.C. de muy alta eficiencia, equipados con variador electrónico de velocidad (VSD), regulable mediante señal externa de control 0-10 V.
- Se recomienda instalar el variador electrónico de velocidad (VSD) fuera de la zona de trabajo.
- La señal externa puede subministrarse a través de un control manual o automático con salida 0-10 V.
- Variador electrónico de velocidad (VSD), disponibles con entrada monofásica 220-240 V 50/60 Hz (Tipo VSD1/B) o trifásica 380-415 V 50/60 Hz (Tipo VSD3/B).

- Por defecto se entrega el variador electrónico de velocidad (VSD) programado a velocidad constante.
- Temperatura de trabajo ventilador: -25 °C +60 °C.
- Temperatura de trabajo (VSD): -25 °C +50 °C.

Acabado:

- Anticorrosivo en chapa de acero galvanizado.

Código de pedido con suministro de variador electrónico (VSD) incluido

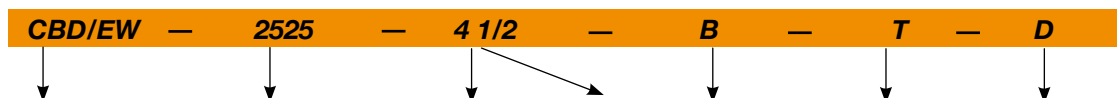

CBD/EW: Ventiladores centrífugos de doble aspiración y turbina con álabes hacia delante, de alta eficiencia, "Efficient work"
 CBD/B/EW: Ventiladores centrífugos de doble aspiración, de alta eficiencia, "Efficient work", con brida de impulsión y sin pies de apoyo

Tamaño turbina mm. pulg.
 1919 7/7
 2525 9/9
 2828 10/10
 3333 12/12

Número de polos:
 4=1410 r/min
 6=960 r/min

Potencia motor en C.V.

Motores Brushless industriales E.C.

M: Equipados con VSD1/B, variador electrónico de velocidad, alimentación monofásica 220-240 V 50/60 Hz.

T: Equipados con VSD3/B, variador electrónico de velocidad, alimentación trifásica 380-415 V 50/60 Hz.

D: Versión estándar, suministro del VSD programado a velocidad constante.
 P: Suministro con VSD programado para control de presión y transmisor de presión Si-Presión
 K: Suministro con VSD programado e integrado en una caja BOXPRES KIT/B para el control de presión.

Características técnicas

Modelo	Velocidad min/max (r/min)	Equivalencia pulgadas	VSD monofásico 230 V 50/60 Hz		VSD trifásico 400 V 50/60 Hz		Potencia eléctrica máxima (W)	Caudal máximo min/max (m³/h)	Nivel presión sonora min/max dB(A)	Peso aprox. (Kg)
			Intensidad máxima entrada (A)	Modelo VSD	Intensidad máxima entrada (A)	Modelo VSD				
CBD/EW-1919-4 1/5	300 / 1410	7/7	2,13	VSD1/B-0.37	0,62	VSD3/B-0.75	260	325 / 1520	25 / 59	7,0
CBD/EW-1919-6 1/10	300 / 960	7/7	1,17	VSD1/B-0.37	0,34	VSD3/B-0.75	140	385 / 1230	28 / 53	7,0
CBD/EW-2525-4 1/2	300 / 1410	9/9	3,96	VSD1/B-0.37	0,93	VSD3/B-0.75	450	595 / 2800	32 / 66	13,2
CBD/EW-2525-4 1	300 / 1410	9/9	7,94	VSD1/B-0.75	1,87	VSD3/B-1.5	905	765 / 3600	36 / 70	14,0
CBD/EW-2525-6 1/3	300 / 960	9/9	2,93	VSD1/B-0.37	0,68	VSD3/B-0.75	330	845 / 2700	37 / 62	12,7
CBD/EW-2828-4 1/2	300 / 1410	10/10	3,96	VSD1/B-0.37	0,93	VSD3/B-0.75	450	595 / 2800	31 / 65	15,7
CBD/EW-2828-4 1	300 / 1410	10/10	7,94	VSD1/B-0.75	1,87	VSD3/B-1.5	905	840 / 3950	36 / 70	16,5
CBD/EW-2828-6 1/3	300 / 960	10/10	2,93	VSD1/B-0.37	0,68	VSD3/B-0.75	330	1000 / 3200	37 / 62	15,2
CBD/EW-3333-6 1	300 / 960	12/12	8,32	VSD1/B-1.5	1,96	VSD3/B-1.5	955	1875 / 6000	46 / 71	24,0
CBD/EW-3333-6 1 1/2	300 / 960	12/12	11,51	VSD1/B-1.5	2,71	VSD3/B-1.5	1325	2440 / 7800	50 / 75	24,5

Características acústicas a velocidad máxima

Los valores indicados se determinan mediante medidas de potencia sonora en dB(A) obtenidas en campo libre a una distancia equivalente a dos veces la envergadura del ventilador más el diámetro de la turbina, con un mínimo de 1,5m.

Espectro de potencia sonora Lw(A) en dB(A) banda de frecuencia en [Hz]

Modelo	63	125	250	500	1000	2000	4000	8000	Modelo	63	125	250	500	1000	2000	4000	8000
CBD/EW-1919-4_1/5	29	44	55	63	65	64	63	55	CBD/EW-2828-4_1/2	35	50	61	69	71	70	69	61
CBD/EW-1919-6_1/10	23	38	49	57	59	58	57	49	CBD/EW-2828-4_1	40	55	66	74	76	75	74	66
CBD/EW-2525-4_1/2	36	51	62	70	72	71	70	62	CBD/EW-2828-6_1/3	32	47	58	66	68	67	66	58
CBD/EW-2525-4_3/4	40	55	66	74	76	75	74	66	CBD/EW-3333-6_1	41	56	67	75	77	76	75	67
CBD/EW-2525-6_1/3	32	47	58	66	68	67	66	58	CBD/EW-3333-6_1 1/2	45	60	71	79	81	80	79	71

Dimensiones mm

CBD- 1919...3333

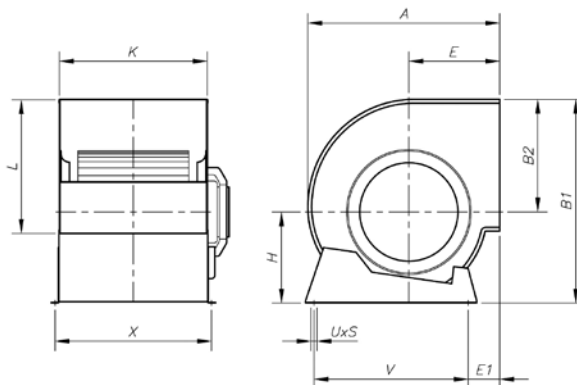

Modelo	Equiv. pulg.	A	B1	B2	E	E1	G	H	K	L	UxS	V	X	x1	x2
CBD/EW-1919	7/7	315	333	189	152	64	-	144	230	208	9x13	225	258	-	-
CBD/EW-2525	9/9	380	400	218	183	78	-	182	300	263	9x13	275	328	-	-
CBD/EW-2828	10/10	422	450	246	202	73	-	204	326	292	9x17	315	355	-	-
CBD/EW-3333	12/12	493	526	290	230	82	-	236	387	345	9x17	390	415	-	-

CBD/B/EW

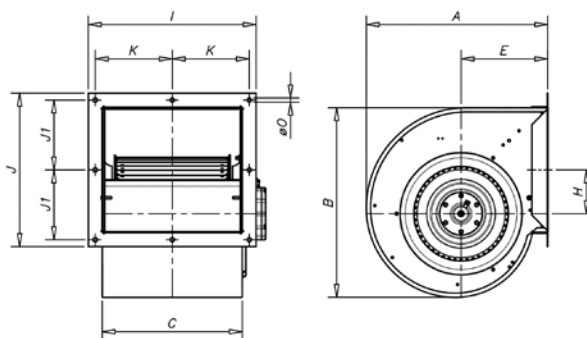

Modelo	Equiv. Pulg.	A	B	C	E	H	I	J	J1	K	K1	L	øO
CBD/B/EW-1919	7/7	315	322	230	152	86,5	295	273	120,5	131,5	-	-	10
CBD/B/EW-2525	9/9	380	393	300	183	89	365	328	148	166,5	-	-	10
CBD/B/EW-2828	10/10	422	442	326	202	102	391	357	162,5	179,5	-	-	10
CBD/B/EW-3333	12/12	493	527	387	230	121	452	410	189	210	-	-	10



Erp. Curvas características y datos ErP

Ver curvas modelo CBD/EW-CJBD/EW

Accesorios

Ver apartado accesorios.



INT



PSB



UNIDADES DE CONTROL Y SENSORES



EFFICIENT WORK



CJBD/EW CJBD/EW/AL



CJBD/EW



CJBD/EW/AL



VARIADOR VELOCIDAD
VSD: Variador electrónico de velocidad.
. VSD1/B
. VSD3/B

Suministro incluido con el ventilador

CONTROL
Suministro como accesorio opcional

ALIMENTACIÓN
VSD1/B:
220-240 V 50/60 Hz
VSD3/B:
380-415 V 50/60 Hz

CJBD/EW: Unidades de ventilación, aisladas acústicamente, equipadas con ventiladores CBD/EW con motor Brushless industrial E.C.

CJBD/EW/AL: Unidades de ventilación con perfiles de aluminio y chapa prelacada aisladas acústicamente, equipadas con ventiladores CBD/EW con motor Brushless industrial E.C.

Ventilador:

- Envoltorio en chapa de acero galvanizado.
- Turbina con álabes hacia delante, en chapa de acero galvanizado
- Se suministra con pies soporte PSB.
- Variador electrónico de velocidad (VSD), monofásico o trifásico, incluido con el ventilador.

Motor y variador electrónico:

- Motores brushless industriales E.C. de muy alta eficiencia, equipados con variador electrónico de velocidad (VSD), regulable mediante señal externa de control 0-10 V.
- Se recomienda instalar el variador electrónico de velocidad (VSD) fuera de la zona de trabajo.
- La señal externa puede suministrarse a través de un control manual o automático con salida 0-10 V.
- Variador electrónico de velocidad (VSD), disponibles con entrada monofásica 220-240 V 50/60 Hz (Tipo VSD1/B) o trifásica 380-415 V 50/60 Hz (Tipo VSD3/B).
- Por defecto se entrega el variador electrónico de velocidad (VSD) programado a velocidad constante.
- Temperatura de trabajo ventilador: -25 °C +60 °C.
- Temperatura de trabajo (VSD): -25 °C +50 °C.

Acabado:

- Anticorrosivo en chapa de acero galvanizado

Código de pedido con suministro de variador electrónico (VSD) incluido

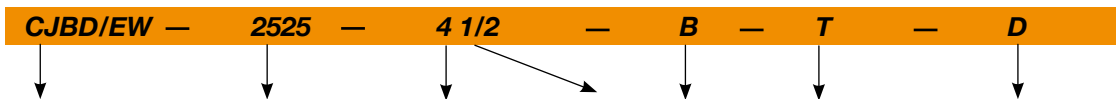

CJBD/EW: Unidades de filtración de alta eficiencia, "Efficient work", aisladas acústicamente

CJBD/EW/AL: Unidades de filtración de alta eficiencia, "Efficient work", con perfiles de aluminio y chapa prelacada aisladas acústicamente

CJBD/EW/C: Unidades de filtración de alta eficiencia, "Efficient work", con entrada y salida circular.

CJBD/EW/F: Unidades de filtración de alta eficiencia, "Efficient work", con filtro incorporado.

CJBD/EW/ALS: Unidades de filtración de alta eficiencia, "Efficient work", con doble pared de aislamiento y chapa prelacada.

CJBD/EW/ALF: Unidades de filtración de alta eficiencia, "Efficient work", con chapa prelacada y filtro incorporado.

Tamaño turbina mm.	2525
1919	2828
3333	

Número de polos:	4=1410 r/min
6=960 r/min	

Potencia motor en C.V.

Motores Brushless industriales E.C.

M: Equipados con VSD1/B, variador electrónico de velocidad, alimentación monofásica 220-240 V 50/60 Hz.

T: Equipados con VSD3/B, variador electrónico de velocidad, alimentación trifásica 380-415 V 50/60 Hz.

D: Versión estándar, suministro del VSD programado a velocidad constante. P: Suministro con VSD programado para control de presión y transmisor de presión Si-Presión K: Suministro con VSD programado e integrado en una caja BOXPRES KIT/B para el control de presión.

Opciones



CJBD/C/EW



CJBD/F/EW



CJBD/ALS/EW



CJBD/ALF/EW

Características técnicas

Modelo	Velocidad min/max (r/min)	Equivalencia pulgadas	VSD monofásico 230 V 50/60 Hz Intensidad máxima entrada (A)	VSD trifásico 400 V 50/60 Hz Intensidad máxima entrada (A)	Potencia eléctrica máxima (W)	Caudal máximo min/max (m³/h)	Nivel presión sonora min/max dB(A)	Peso aprox. (Kg)		
CJBD/EW CJBD/EW/AL 1919-4 1/5	300 / 1410	7/7	2,13	VSD1/B-0.37	0,62	VSD3/B-0.75	260	325 / 1520	25 / 59	7,0
CJBD/EW CJBD/EW/AL 1919-6 1/10	300 / 960	7/7	1,17	VSD1/B-0.37	0,34	VSD3/B-0.75	140	385 / 1230	28 / 53	7,0
CJBD/EW CJBD/EW/AL 2525-4 1/2	300 / 1410	9/9	3,96	VSD1/B-0.37	0,93	VSD3/B-0.75	450	595 / 2800	32 / 66	13,2
CJBD/EW CJBD/EW/AL 2525-4 1	300 / 1410	9/9	7,94	VSD1/B-0.75	1,87	VSD3/B-1.5	905	765 / 3600	36 / 70	14,0
CJBD/EW CJBD/EW/AL 2525-6 1/3	300 / 960	9/9	2,93	VSD1/B-0.37	0,68	VSD3/B-0.75	330	845 / 2700	37 / 62	12,7
CJBD/EW CJBD/EW/AL 2828-4 1/2	300 / 1410	10/10	3,96	VSD1/B-0.37	0,93	VSD3/B-0.75	450	595 / 2800	31 / 65	15,7
CJBD/EW CJBD/EW/AL 2828-4 1	300 / 1410	10/10	7,94	VSD1/B-0.75	1,87	VSD3/B-1.5	905	840 / 3950	36 / 70	16,5
CJBD/EW CJBD/EW/AL 2828-6 1/3	300 / 960	10/10	2,93	VSD1/B-0.37	0,68	VSD3/B-0.75	330	1000 / 3200	37 / 62	15,2
CJBD/EW CJBD/EW/AL 3333-6 1	300 / 960	12/12	8,32	VSD1/B-1.5	1,96	VSD3/B-1.5	955	1875 / 6000	46 / 71	24,0
CJBD/EW CJBD/EW/AL 3333-6 1 1/2	300 / 960	12/12	11,51	VSD1/B-1.5	2,71	VSD3/B-1.5	1325	2440 / 7800	50 / 75	24,5

Características acústicas a velocidad máxima

Los valores indicados se determinan mediante medidas de potencia sonora en dB(A) obtenidas en campo libre a una distancia equivalente a dos veces la envergadura del ventilador más el diámetro de la turbina, con un mínimo de 1,5m.

Espectro de potencia sonora Lw(A) en dB(A) banda de frecuencia en [Hz]

Modelo	63	125	250	500	1000	2000	4000	8000	Modelo	63	125	250	500	1000	2000	4000	8000
1919-4 1/5	43	54	58	62	64	63	62	53	2828-4 1/2	50	61	65	69	71	70	69	60
1919-6 1/10	38	49	53	57	59	58	57	48	2828-4 1	55	66	70	74	76	75	74	65
2525-4 1/2	51	62	66	70	72	71	70	61	2828-6 1/3	46	57	61	65	67	66	65	56
2525-4 1	55	66	70	74	76	75	74	65	3333-6 1	55	66	70	74	76	75	74	65
2525-6 1/3	46	57	61	65	67	66	65	56	3333-6 1 1/2	59	70	74	78	80	79	78	69

Dimensiones mm

CJBD/EW
CJBD/EW/F

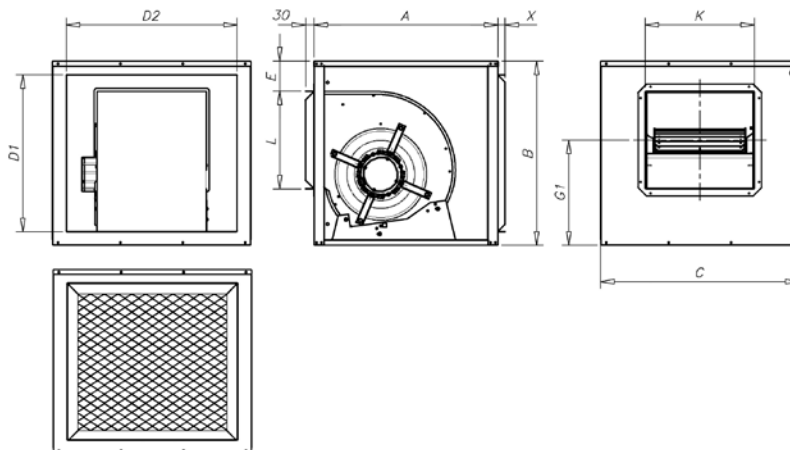

Tamaño	A	B	C	E	D1	D2	G1	L	K	(sin filtro) X	(con filtro) X	
CJBD/EW-1919	7/7	450	460	500	110	370	410	245	210	232	25	30
CJBD/EW-2525	9/9	500	522	550	107	426	454	283,5	263	300	25	30
CJBD/EW-2828	10/10	550	575	600	105,5	479	504	324,5	292	326	25	30
CJBD/EW-3333	12/12	650	650	700	106	554	604	372,5	345	387	25	30

Accesorios

Ver apartado accesorios.



INT



TEJ



VIS



UNIDADES DE CONTROL Y SENSORES



EFFICIENT WORK



Dimensiones mm

Dimensions in mm

Abmessungen in mm

Dimensions mm

CJBD/EW/C

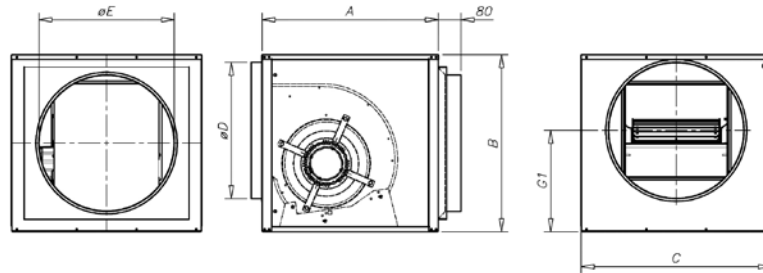

Modelo	Equiv. pulg.	A	B	C	øD	D1	øE	D2	G1
CJBD/EW/C-1919	7/7	450	460	500	250	370	250	410	245
CJBD/EW/C-2525	9/9	500	522	550	355	426	355	454	283,5
CJBD/EW/C-2828	10/10	550	575	600	400	479	400	504	324,5
CJBD/EW/C-3333	12/12	650	650	700	500	554	500	604	372,5

**CJBD/EW/AL
CJBD/EW/ALS
CJBD/EW/ALF**

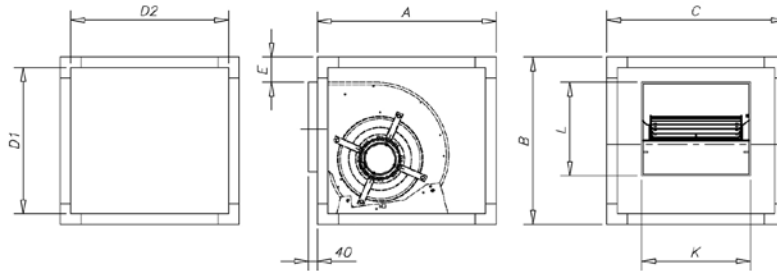

Modelo	Tamaño	A	B	C	D1	D2	E	L	K
CJBD/EW/AL-1919	7/7	460	460	460	420	420	88	202	225
CJBD/EW/AL-2525	9/9	520	520	520	480	480	110	265	295
CJBD/EW/AL-2828	10/10	575	575	575	535	535	122	286	322
CJBD/EW/AL-3333	12/12	650	650	650	610	610	108	339	384

Curvas características

Ver curvas características serie CBD/EW-CJBD/EW

Curvas características de pérdida de carga de las unidades con filtro

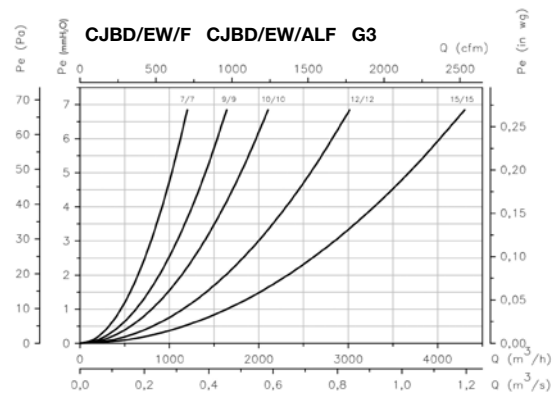
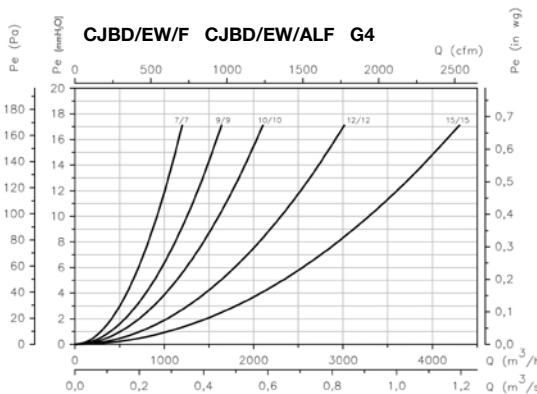



Erp. Curvas características y datos ErP

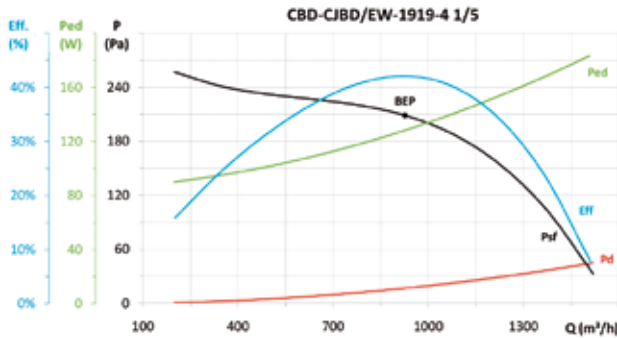

MC	EC	SR	Cc	η_b (%)*	N	[kW]	[m³/h]	[Pa]	[rpm]	VSD
A	S	1,00	1,15	48,4%	60,3	0,128	926	208,7	1410	INCLUDED

* η_e (%) = Eff. (%) x Cc

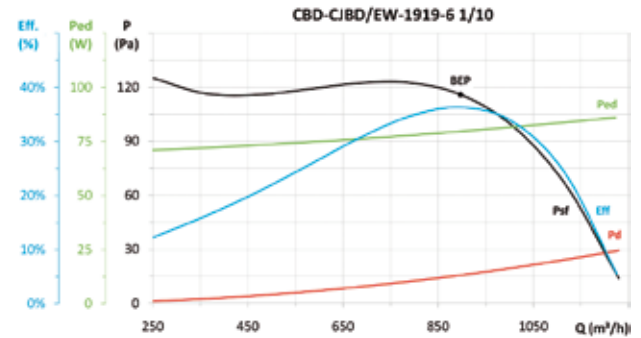

MC	EC	SR	Cc	η_b (%)*	N	[kW]	[m³/h]	[Pa]	[rpm]	VSD
A	S	-	-	-	-	0,080	897	115,9	960	INCLUDED

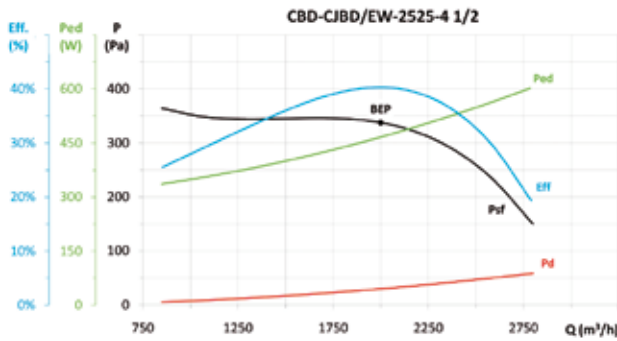

MC	EC	SR	Cc	η_b (%)*	N	[kW]	[m³/h]	[Pa]	[rpm]	VSD
A	S	1,00	1,11	44,8%	53,2	0,465	2000	337,4	1410	INCLUDED

* η_e (%) = Eff. (%) x Cc

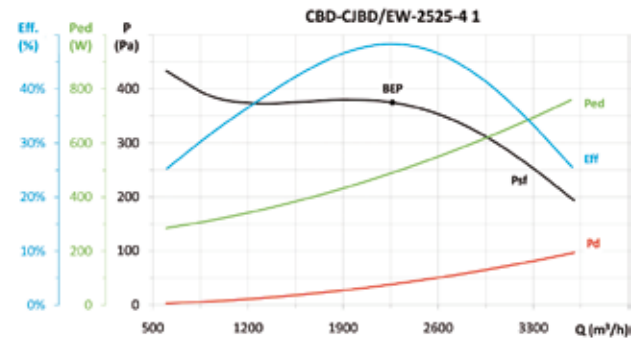

MC	EC	SR	Cc	η_b (%)*	N	[kW]	[m³/h]	[Pa]	[rpm]	VSD
A	S	1,00	1,11	53,6%	61,9	0,488	2265	374,7	1410	INCLUDED

* η_e (%) = Eff. (%) x Cc

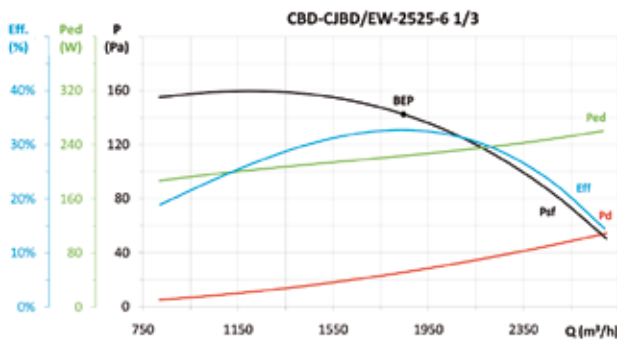

MC	EC	SR	Cc	η_b (%)*	N	[kW]	[m³/h]	[Pa]	[rpm]	VSD
A	S	1,00	1,13	37,1%	47,5	0,223	1846	142,5	960	INCLUDED

* η_e (%) = Eff. (%) x Cc

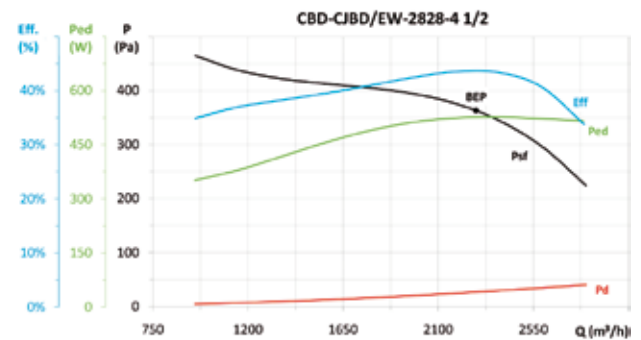

MC	EC	SR	Cc	η_b (%)*	N	[kW]	[m³/h]	[Pa]	[rpm]	VSD
A	S	1,00	1,11	48,3%	56,4	0,527	2279	363,1	1410	INCLUDED

* η_e (%) = Eff. (%) x Cc

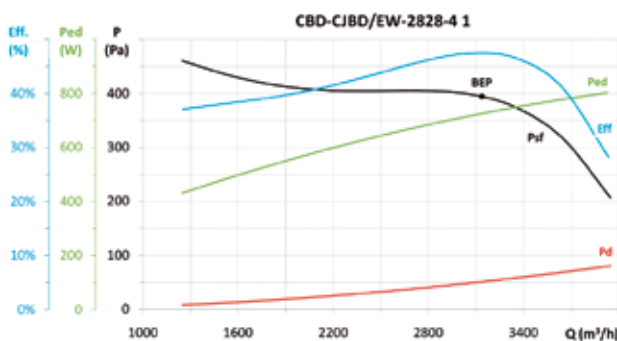

MC	EC	SR	Cc	η_b (%)*	N	[kW]	[m³/h]	[Pa]	[rpm]	VSD
A	S	1,00	1,10	52,1%	59,4	0,723	3138	394,1	1410	INCLUDED

* η_e (%) = Eff. (%) x Cc

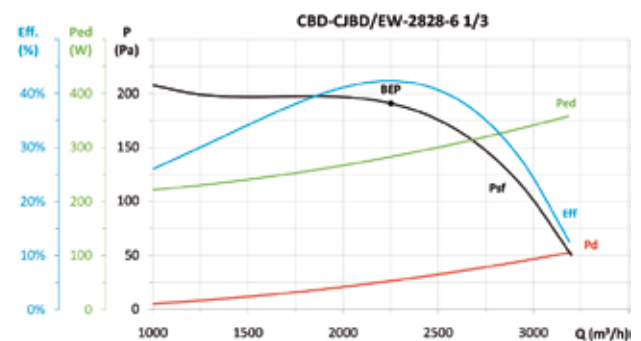

MC	EC	SR	Cc	η_b (%)*	N	[kW]	[m³/h]	[Pa]	[rpm]	VSD
A	S	1,00	1,13	47,6%	57,4	0,282	2251	190,6	960	INCLUDED

* η_e (%) = Eff. (%) x Cc



EFFICIENT WORK



Erp. Curvas características y datos ErP

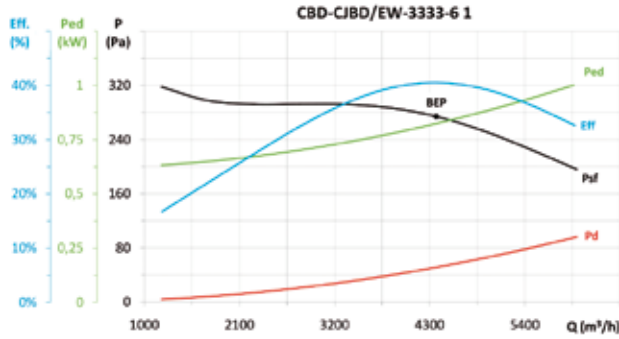

MC	EC	SR	Cc	η_e (%)*	N	[kW]	[m³/h]	[Pa]	[rpm]	VSD
A	S	1,00	1,09	44,3%	51,2	0,822	4377	274,1	960	INCLUDED

* η_e (%) = Eff. (%) x Cc

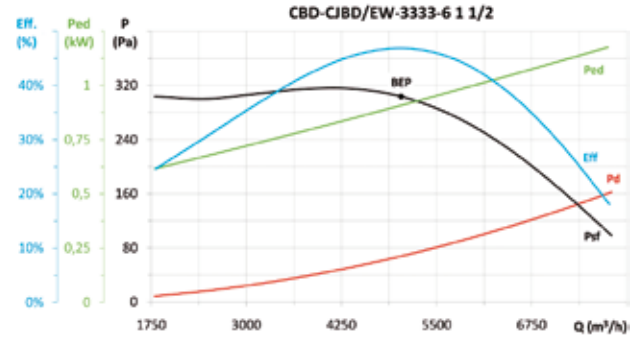

MC	EC	SR	Cc	η_e (%)*	N	[kW]	[m³/h]	[Pa]	[rpm]	VSD
A	S	1,00	1,09	51,1%	57,7	0,906	5035	303,7	960	INCLUDED

* η_e (%) = Eff. (%) x Cc



CMA/EW

MOTOR BRUSHLESS INDUSTRIAL E.C.

VARIADOR VELOCIDAD
 VSD: Variador electrónico de velocidad.
 . VSD1/B
 . VSD3/B

Suministro incluido con el ventilador

CONTROL
 Suministro como accesorio opcional

ALIMENTACIÓN
 VSD1/B:
 220-240 V 50/60 Hz
 VSD3/B:
 380-415 V 50/60 Hz

Ventiladores centrífugos de media presión y simple aspiración con envoltorio y turbina en fundición de aluminio, equipados con motor Brushless industrial E.C.

Ventilador:

- Envoltorio en fundición de aluminio.
- Turbina en fundición de aluminio.
- Modelos 324, 325 y 426 con turbina en poliamida, modelo 531-2T-3 en chapa de acero.
- Variador electrónico de velocidad (VSD), monofásico o trifásico, incluido con el ventilador.

Motor y variador electrónico:

- Motores brushless industriales E.C. de muy alta eficiencia, equipados con variador electrónico de velocidad (VSD), regulable mediante señal externa de control 0-10 V.
- Se recomienda instalar el variador electrónico de velocidad (VSD) fuera de la zona de trabajo.
- La señal externa puede suministrarse a través de un control manual o automático con salida 0-10 V.
- Variador electrónico de velocidad (VSD), disponibles con entrada monofásica 220-240 V 50/60 Hz (Tipo VSD1/B) o trifásica 380-415 V 50/60 Hz (Tipo VSD3/B).
- Por defecto se entrega el variador electrónico de velocidad (VSD) programado a velocidad constante.

Temperatura de trabajo ventilador:

-25 °C +120 °C.

Temperatura de trabajo (VSD):

-25 °C +50 °C.

Acabado:

- Anticorrosivo en resina de poliéster polimerizada a 190 °C, previo desengrase con tratamiento nanotecnológico libre de fosfatos.

Bajo demanda:

- Turbinas en fundición de aluminio para los modelos 324, 325 y 426.

Código de pedido con suministro de variador electrónico (VSD) incluido

CMA/EW — 531 — 2 — 1,5 — B — T — D

CMA/EW: Ventiladores centrífugos de media presión y simple aspiración con envoltorio y turbina en fundición de aluminio, de alta eficiencia, "Efficient work"

Tamaño turbina

Número de polos:
2=2850 r/min

Potencia motor en CV

Motores Brushless industriales E.C.

M: Equipados con VSD1/B, variador electrónico de velocidad, alimentación monofásica 220-240 V 50/60 Hz.

T: Equipados con VSD3/B, variador electrónico de velocidad, alimentación trifásica 380-415 V 50/60 Hz.

D: Versión estándar, suministro del VSD programado a velocidad constante.
P: Suministro con VSD programado para control de presión y transmisor de presión Si-Presión
K: Suministro con VSD programado e integrado en una caja BOXPRES KIT/B para el control de presión.

Características técnicas

Modelo	Velocidad min/max (r/min)	VSD monofásico 230 V 50/60 Hz		VSD trifásico 400 V 50/60 Hz		Potencia eléctrica máxima (W)	Caudal máximo min/max (m³/h)	Nivel presión sonora min/max dB(A)	Peso aprox. (Kg)
		Intensidad máxima entrada (A)	Modelo VSD	Intensidad máxima entrada (A)	Modelo VSD				
CMA/EW-218-2	300 / 2850	2,09	VSD1/B-0.37	0,61	VSD3/B-0.75	255	30 / 265	14 / 63	6,0
CMA/EW-324-2	300 / 2850	2,09	VSD1/B-0.37	0,61	VSD3/B-0.75	255	45 / 440	21 / 70	9,0
CMA/EW-325-2	300 / 2850	2,86	VSD1/B-0.37	0,84	VSD3/B-0.75	345	65 / 600	24 / 73	11,0
CMA/EW-426-2	300 / 2850	4,08	VSD1/B-0.37	1,20	VSD3/B-0.75	495	90 / 850	26 / 75	13,0
CMA/EW-527-2	300 / 2850	5,99	VSD1/B-0.37	1,76	VSD3/B-0.75	730	105 / 1000	31 / 80	14,8
CMA/EW-528-2-1	300 / 2850	8,15	VSD1/B-0.75	1,92	VSD3/B-0.75	925	130 / 1250	33 / 82	23,5
CMA/EW-528-2-1.5	300 / 2850	11,80	VSD1/B-0.75	2,78	VSD3/B-1.5	1345	185 / 1750	34 / 83	26,0
CMA/EW-531-2-1.5	300 / 2850	11,80	VSD1/B-0.75	2,78	VSD3/B-1.5	1345	190 / 1790	35 / 84	29,0
CMA/EW-531-2-2	300 / 2850	15,89	VSD1/B-1.5	3,74	VSD3/B-1.5	1810	210 / 2000	36 / 85	31,0
CMA/EW-531-2-3	300 / 2850	23,11	VSD1/B-2.2	5,45	VSD3/B-2.2	2630	255 / 2400	37 / 86	30,0
CMA/EW-540-2	300 / 2850	15,89	VSD1/B-1.5	3,74	VSD3/B-1.5	1810	275 / 2600	36 / 85	38,0
CMA/EW-545-2-3	300 / 2850	23,11	VSD1/B-2.2	5,45	VSD3/B-2.2	2630	275 / 2630	37 / 86	54,0



EFFICIENT WORK



Características acústicas a velocidad máxima

Los valores indicados se determinan mediante medidas de potencia sonora en dB(A) obtenidas en campo libre a una distancia equivalente a dos veces la envergadura del ventilador más el diámetro de la turbina, con un mínimo de 1,5m.

Espectro de potencia sonora Lw(A) en dB(A) banda de frecuencia en [Hz]

Modelo	63	125	250	500	1000	2000	4000	8000	Modelo	63	125	250	500	1000	2000	4000	8000
CMA/EW-218-2	29	43	61	67	71	68	63	54	CMA/EW-528-2-1.5	49	63	81	87	91	88	83	74
CMA/EW-324-2	36	50	68	74	78	75	70	61	CMA/EW-531-2-1.5	50	64	82	88	92	89	84	75
CMA/EW-325-2	39	53	71	77	81	78	73	64	CMA/EW-531-2-2	51	65	83	89	93	90	85	76
CMA/EW-426-2	41	55	73	79	83	80	75	66	CMA/EW-531-2-3	52	66	84	90	94	91	86	77
CMA/EW-527-2	46	60	78	84	88	85	80	71	CMA/EW-540-2	54	67	85	91	96	92	87	79
CMA/EW-528-2-1	48	62	80	86	90	87	82	73	CMA/EW-545-2-3	55	68	86	92	97	93	88	80

Dimensiones mm

CMA/EW-218...531

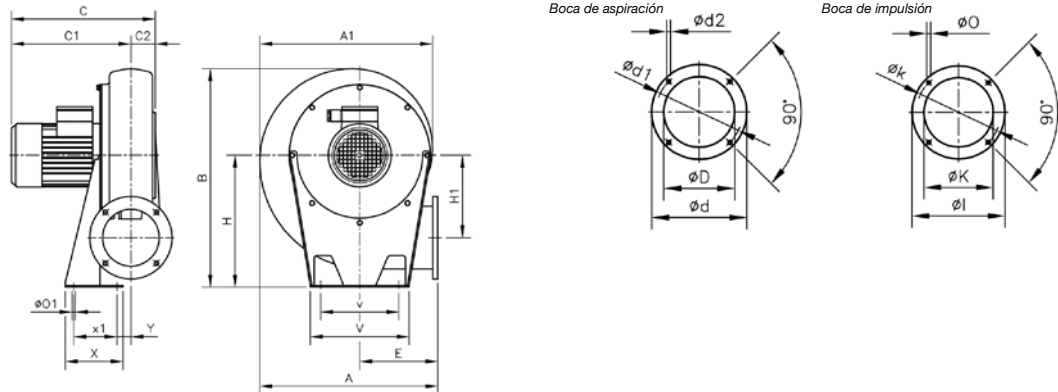

Modelo	A	A1	B	C	C1	C2	ØD	Ød	Ød1	Ød2	E	H	H1	Øl	ØK	øk	Ø0	Ø01	V	v	X	x1	Y
CMA/EW-218-2	241	236	288	239	208	32	80	113	90	M5	110	170	114,5	90	54	76	5,5	7	140	100	80	50	20
CMA/EW-324-2	311	302	356	268	202	38	80	130	112	M5	145	205	145	108	62	90	7	9	173	125	90	60	20
CMA/EW-325-2	335	328	399	271	223	40	94	140	122	M6	155	235	152	120	80	102	7	9	180	145	110	80	20
CMA/EW-426-2	354	344	412	291	250	40	117	155	132	M6	162	240	163	140	90	119	7	13	210	160	105	65	26
CMA/EW-527-2	371	361	440	295	254	42	125	170	147	M6	168	260	170	155	100	129	7	13	220	170	120	80	20
CMA/EW-528-2-1	401	395	488	340	289	51	116	190	162	M6	178	290	177	190	130	160	11	13	230	180	140	100	20
CMA/EW-528-2-1.5	401	395	488	337	289	48	135	190	162	M6	178	290	177	190	130	160	11	13	230	180	140	100	20
CMA/EW-531-2-1.5	440	434	537	341	290	50	160	215	180	M6	193	320	200	200	140	175	11	13	240	190	160	120	21
CMA/EW-531-2-2	440	434	537	388	340	50	160	215	180	M6	193	320	200	200	140	175	11	13	240	190	160	120	21
CMA/EW-531-2-3	440	434	537	388	350	50	160	215	180	M6	193	320	200	200	140	175	11	13	240	190	160	120	21

CMA/EW-540-545

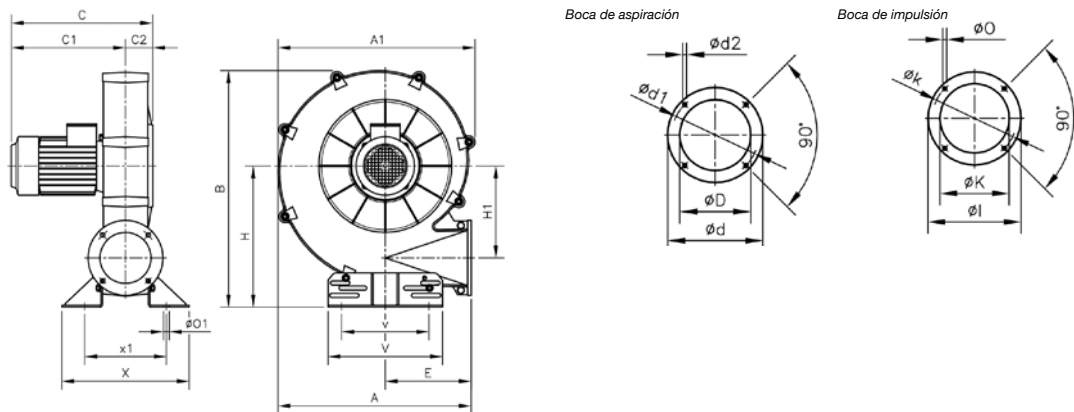

Modelo	A	A1	B	C	C1	C2	ØD	Ød	Ød1	Ød2	E	H	H1	Øl	ØK	øk	Ø0	Ø01	V	v	X	x1
CMA/EW-540-2	567	580	695	375	320	80	170	240	205	M10	252	415	270	220	150	190	13	11	336	218	374	240
CMA/EW-545-2-3	651	646	776	423	344	115	180	255	220	M10	290	450	309	250	175	220	13	13	336	238	392	292

Orientaciones

Suministro standard LG 270. Posición LG 180 bajo demanda y con medidas de anclaje especiales





Erp. Curvas características y datos ErP

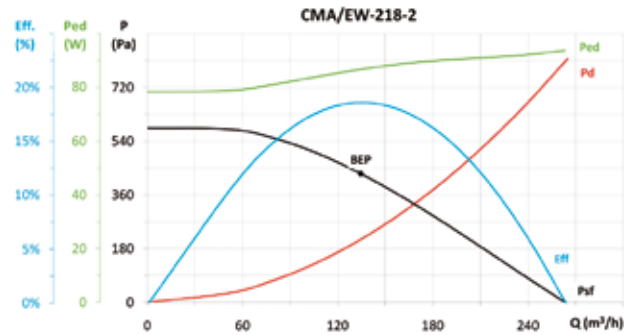

MC	EC	SR	Cc	η_a (%)*	N	[kW]	[m³/h]	[Pa]	[rpm]	VSD
A	S	-	-	-	-	0,087	135	431	2850	INCLUDED

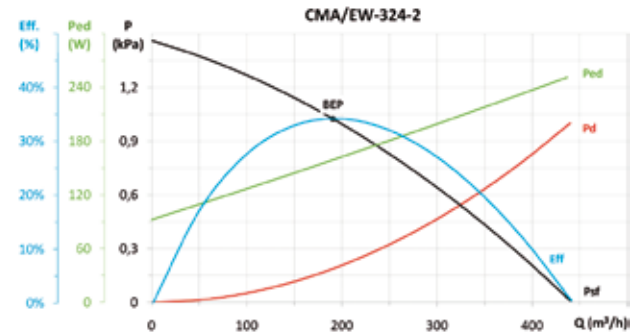

MC	EC	SR	Cc	η_a (%)*	N	[kW]	[m³/h]	[Pa]	[rpm]	VSD
A	S	1,01	1,14	39,1%	50,5	0,158	191	1024	2850	INCLUDED

* η_e (%) = Eff. (%) x Cc

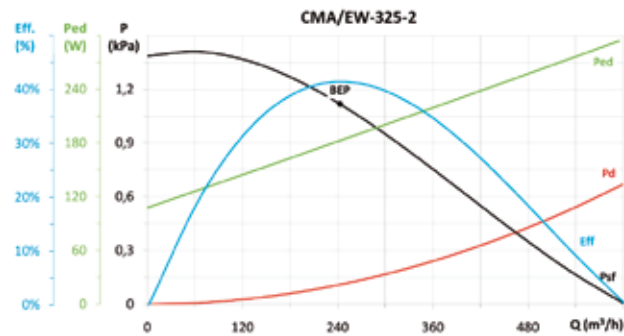

MC	EC	SR	Cc	η_a (%)*	N	[kW]	[m³/h]	[Pa]	[rpm]	VSD
A	S	1,01	1,14	47,2%	58,2	0,182	243	1118	2850	INCLUDED

* η_e (%) = Eff. (%) x Cc

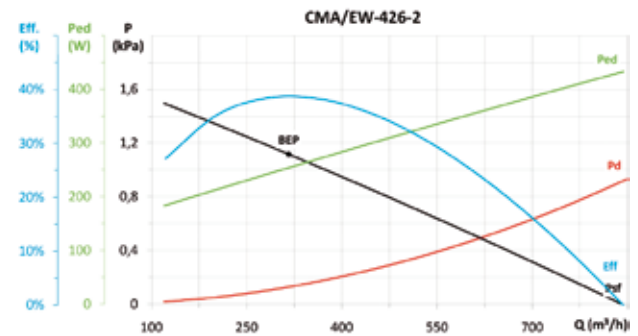

MC	EC	SR	Cc	η_a (%)*	N	[kW]	[m³/h]	[Pa]	[rpm]	VSD
A	S	1,01	1,13	43,7%	53,8	0,253	316	1117	2850	INCLUDED

* η_e (%) = Eff. (%) x Cc

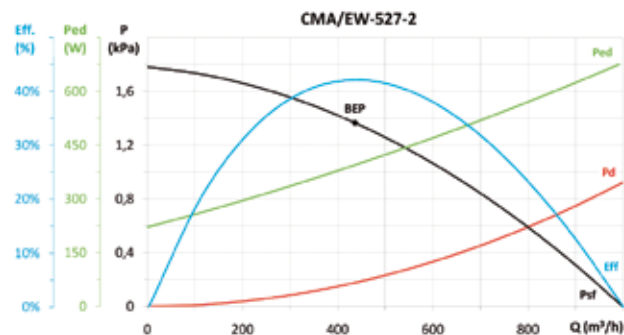

MC	EC	SR	Cc	η_a (%)*	N	[kW]	[m³/h]	[Pa]	[rpm]	VSD
A	S	1,02	1,12	47,0%	55,9	0,393	436	1365	2850	INCLUDED

* η_e (%) = Eff. (%) x Cc

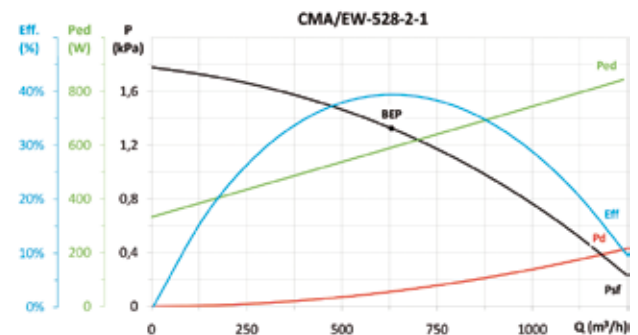

MC	EC	SR	Cc	η_a (%)*	N	[kW]	[m³/h]	[Pa]	[rpm]	VSD
A	S	1,01	1,10	43,5%	51,3	0,589	631	1324	2850	INCLUDED

* η_e (%) = Eff. (%) x Cc

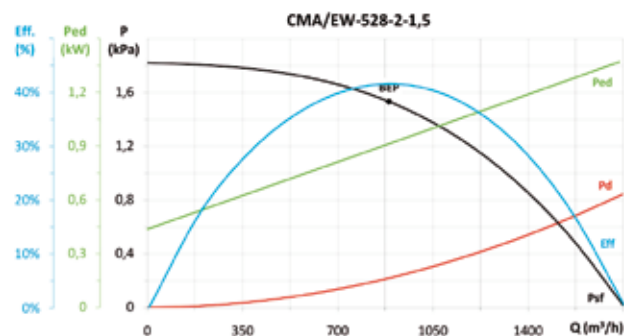

MC	EC	SR	Cc	η_a (%)*	N	[kW]	[m³/h]	[Pa]	[rpm]	VSD
A	S	1,02	1,09	45,3%	51,9	0,909	889	1530	2850	INCLUDED

* η_e (%) = Eff. (%) x Cc

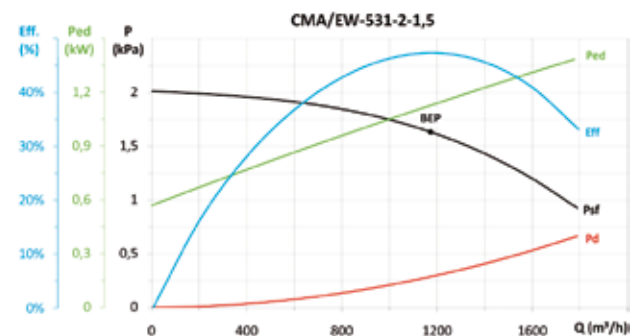

MC	EC	SR	Cc	η_a (%)*	N	[kW]	[m³/h]	[Pa]	[rpm]	VSD
A	S	1,02	1,08	51,3%	57,3	1,123	1173	1630	2850	INCLUDED

* η_e (%) = Eff. (%) x Cc



EFFICIENT WORK



Erp. Curvas características y datos ErP

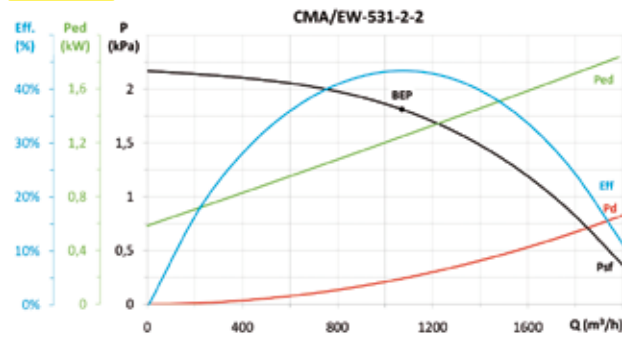

MC	EC	SR	Cc	η_e (%)*	N	[kW]	[m³/h]	[Pa]	[rpm]	VSD
A	S	1,02	1,08	46,9%	52,7	1,242	1071	1811	2850	INCLUDED

* η_e (%) = Eff. (%) x Cc

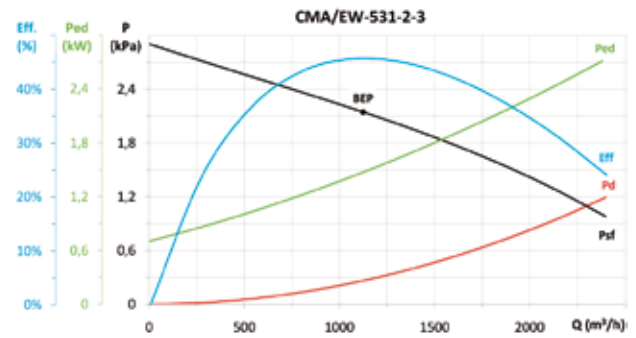

MC	EC	SR	Cc	η_e (%)*	N	[kW]	[m³/h]	[Pa]	[rpm]	VSD
A	S	1,02	1,08	49,2%	54,5	1,465	1125	2143	2850	INCLUDED

* η_e (%) = Eff. (%) x Cc

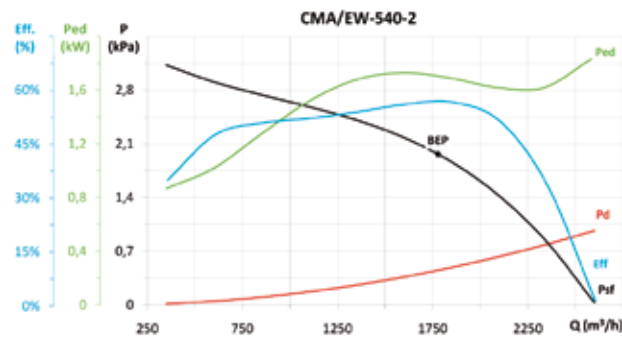

MC	EC	SR	Cc	η_e (%)*	N	[kW]	[m³/h]	[Pa]	[rpm]	VSD
A	S	1,02	1,07	60,9%	69,0	1,708	1778	1967	2850	INCLUDED

* η_e (%) = Eff. (%) x Cc

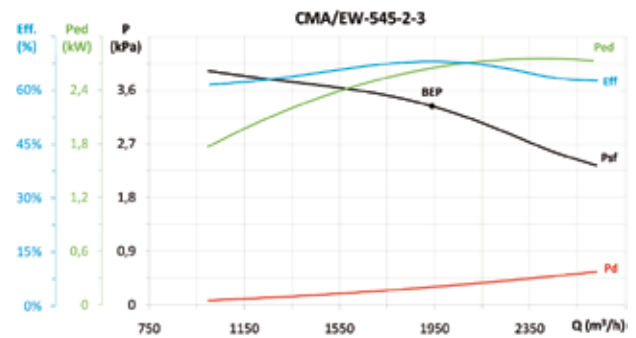

MC	EC	SR	Cc	η_e (%)*	N	[kW]	[m³/h]	[Pa]	[rpm]	VSD
A	S	1,04	1,06	72,0%	78,1	2,640	1939	3332	2850	INCLUDED

* η_e (%) = Eff. (%) x Cc

Accesorios

Ver apartado accesorios.



INT



RPA



B



ACE



S



REG



UNIDADES DE CONTROL Y SENSORES

CMP-L/EW

MOTOR BRUSHLESS INDUSTRIAL E.C.

VARIADOR VELOCIDAD
 VSD: Variador electrónico de velocidad.
 . VSD1/B
 . VSD3/B

Suministro incluido con el ventilador

CONTROL
 Suministro como accesorio opcional

ALIMENTACIÓN
 VSD1/B:
 220-240 V 50/60 Hz
 VSD3/B:
 380-415 V 50/60 Hz

Ventiladores centrífugos de media presión y simple aspiración con motor directo y turbina con álabes hacia delante, equipados con motor Brushless industrial E.C.

Ventilador:

- Envoltente en chapa de acero.
- Turbina con álabes a acción, en chapa de acero de gran robustez.
- Variador electrónico de velocidad (VSD), monofásico o trifásico, incluido con el ventilador.

Motor y variador electrónico:

- Motores brushless industriales E.C. de muy alta eficiencia, equipados con variador electrónico de velocidad (VSD), regulable mediante señal externa de control 0-10 V.
- Se recomienda instalar el variador electrónico de velocidad (VSD) fuera de la zona de trabajo.
- La señal externa puede subministrarse a través de un control manual o automático con salida 0-10 V.
- Variador electrónico de velocidad (VSD), disponibles con entrada monofásica

220-240 V 50/60 Hz (Tipo VSD1/B) o trifásica 380-415 V 50/60 Hz (Tipo VSD3/B).

- Por defecto se entrega el variador electrónico de velocidad (VSD) programado a velocidad constante.
- Temperatura de trabajo ventilador: -25 °C +120°C.
- Temperatura de trabajo (VSD): -25 °C +50 °C.

Acabado:

- Anticorrosivo en chapa de acero galvanizado.

Código de pedido con suministro de variador electrónico (VSD) incluido

CMP-L/EW — 922 — 2 — 1.5 — B — T — D

CMP-L/EW: Ventiladores centrífugos de media presión y simple aspiración con envoltente y turbina en chapa de acero, de alta eficiencia "Efficient work"

Tamaño turbina

Número de polos:
2=2850 r/min
4=1400 r/min

Potencia motor en CV

Motores Brushless industriales E.C.

M: Equipados con VSD1/B, variador electrónico de velocidad, alimentación monofásica 220-240 V 50/60 Hz.
T: Equipados con VSD3/B, variador electrónico de velocidad, alimentación trifásica 380-415 V 50/60 Hz.

D: Versión estándar, suministro del VSD programado a velocidad constante.
P: Suministro con VSD programado para control de presión y transmisor de presión Si-Presión
K: Suministro con VSD programado e integrado en una caja BOXPRES KIT/B para el control de presión.

Características técnicas

Modelo	Velocidad min/max (r/min)	VSD monofásico 230 V 50/60 Hz		VSD trifásico 400 V 50/60 Hz		Potencia eléctrica máxima (W)	Caudal máximo min/max (m³/h)	Nivel presión sonora min/max dB(A)	Peso aprox. (Kg)
		Intensidad máxima entrada (A)	Modelo VSD	Intensidad máxima entrada (A)	Modelo VSD				
CMP-L/EW-512-2	300 / 2850	2,09	VSD1/B-0.37	0,61	VSD3/B-0.75	255	40 / 380	13 / 62	4,0
CMP-L/EW-512-4	300 / 1410	1,14	VSD1/B-0.37	0,34	VSD3/B-0.75	140	55 / 255	21 / 55	4,0
CMP-L/EW-514-2	300 / 2850	2,09	VSD1/B-0.37	0,61	VSD3/B-0.75	255	75 / 700	16 / 65	8,0
CMP-L/EW-514-4	300 / 1410	1,14	VSD1/B-0.37	0,34	VSD3/B-0.75	140	120 / 565	34 / 68	8,0
CMP-L/EW-616-2	300 / 2850	5,99	VSD1/B-0.37	1,76	VSD3/B-0.75	730	145 / 1380	20 / 69	9,5
CMP-L/EW-616-4	300 / 1410	1,44	VSD1/B-0.37	0,42	VSD3/B-0.75	175	180 / 850	27 / 61	9,5
CMP-L/EW-620-2	300 / 2850	5,99	VSD1/B-0.37	1,76	VSD3/B-0.75	730	80 / 765	19 / 68	9,5
CMP-L/EW-620-4	300 / 1410	1,44	VSD1/B-0.37	0,42	VSD3/B-0.75	175	170 / 810	27 / 61	9,5
CMP-L/EW-718-2	300 / 2850	8,15	VSD1/B-0.75	1,92	VSD3/B-0.75	925	155 / 1485	21 / 70	12,5
CMP-L/EW-718-4	300 / 1410	2,79	VSD1/B-0.37	0,82	VSD3/B-0.75	340	270 / 1280	29 / 63	12,5
CMP-L/EW-820-2	300 / 2850	11,80	VSD1/B-0.75	2,78	VSD3/B-1.5	1345	205 / 1950	24 / 73	15,0
CMP-L/EW-820-4	300 / 1410	2,79	VSD1/B-0.37	0,82	VSD3/B-0.75	340	355 / 1670	31 / 65	15,0
CMP-L/EW-922-2-1.5	300 / 2850	11,80	VSD1/B-0.75	2,78	VSD3/B-1.5	1345	175 / 1650	21 / 70	20,0
CMP-L/EW-922-2-2	300 / 2850	15,89	VSD1/B-1.5	3,74	VSD3/B-1.5	1810	210 / 2010	22 / 71	23,0
CMP-L/EW-922-2-3	300 / 2850	23,11	VSD1/B-2.2	5,45	VSD3/B-2.2	2630	275 / 2600	25 / 74	25,5
CMP-L/EW-922-4	300 / 1410	5,82	VSD1/B-0.75	1,37	VSD3/B-1.5	660	520 / 2450	32 / 66	19,0
CMP-L/EW-1025-2	300 / 2850	23,11	VSD1/B-2.2	5,45	VSD3/B-2.2	2630	220 / 2100	24 / 73	28,5
CMP-L/EW-1025-4	300 / 1410	11,25	VSD1/B-0.75	2,65	VSD3/B-1.5	1295	725 / 3400	36 / 70	38,5



EFFICIENT WORK



Características acústicas a velocidad máxima

Los valores indicados se determinan mediante medidas de potencia sonora en dB(A) obtenidas en campo libre a una distancia equivalente a dos veces la envergadura del ventilador más el diámetro de la turbina, con un mínimo de 1,5m.

Espectro de potencia sonora Lw(A) en dB(A) banda de frecuencia en [Hz]

Modelo	63	125	250	500	1000	2000	4000	8000	Modelo	63	125	250	500	1000	2000	4000	8000
CMP-L/EW-512-2	37	47	58	65	69	66	64	57	CMP-L/EW-718-4	38	48	59	66	70	67	65	58
CMP-L/EW-512-4	30	40	51	58	62	59	57	50	CMP-L/EW-820-2	48	58	69	76	80	77	75	68
CMP-L/EW-514-2	40	50	61	68	72	69	67	60	CMP-L/EW-820-4	41	51	62	69	73	70	68	61
CMP-L/EW-514-4	33	43	54	61	65	62	60	53	CMP-L/EW-922-2-1,5	45	55	66	73	77	74	72	65
CMP-L/EW-616-2	44	54	65	72	76	73	71	64	CMP-L/EW-922-2-2	46	56	67	74	78	75	73	66
CMP-L/EW-616-4	36	46	57	64	68	65	63	56	CMP-L/EW-922-2-3	49	59	70	77	81	78	76	69
CMP-L/EW-620-2	43	53	64	71	75	72	70	63	CMP-L/EW-922-4	41	51	62	69	73	70	68	61
CMP-L/EW-620-4	36	46	57	64	68	65	63	56	CMP-L/EW-1025-2	48	58	69	76	80	77	75	68
CMP-L/EW-718-2	45	55	66	73	77	74	72	65	CMP-L/EW-1025-4	45	55	66	73	77	74	72	65

Dimensiones mm

CMP-L/EW-512...820

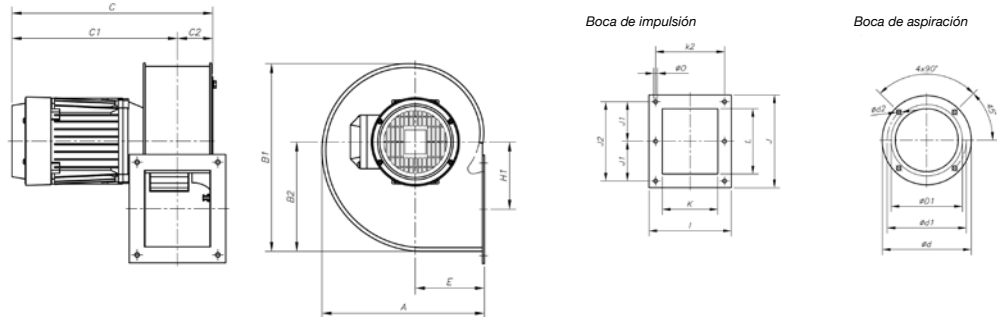

Modelo	A	B1	B2	C	C1	C2	øD1*	ød	ød1	ød2	E	H1	I	J	J1	J2	K	k2	L	øO
CMP-L/EW-512-2	185	206,5	118	251	212	39	112	140	132	M4	82,5	69	104	117	-	104,5	75	92	86	5,5
CMP-L/EW-512-4	185	206,5	118	251	212	39	112	140	132	M4	82,5	69	104	117	-	104,5	75	92	86	5,5
CMP-L/EW-514-2	225	254	150	281	236	45	140	169	151,5	M4	100	91	122	147	64	128	83	105	107	6,5
CMP-L/EW-514-4	225	254	150	281	236	45	140	169	151,5	M4	100	91	122	147	64	128	83	105	107	6,5
CMP-L/EW-616-2	258	297	173,5	320	264	56	160	204	180	M6	110	105,5	153	172	-	147	103	128	125	7
CMP-L/EW-616-4	258	297	173,5	283	227	56	160	204	180	M6	110	105,5	153	172	-	147	103	128	125	7
CMP-L/EW-620-2	298	347	202,5	321	265	56	200	247	230	M6	126	145,5	159	153	-	128	105	134	100	8
CMP-L/EW-620-4	298	347	202,5	283	227	56	200	247	230	M6	126	145,5	159	153	-	128	105	134	100	8
CMP-L/EW-718-2	303,5	348	201	355	294	61	180	238	210	M6	129,5	122	169	192	85	170	115	145	146	9
CMP-L/EW-718-4	303,5	348	201	331	270	61	180	238	210	M6	129,5	122	169	192	85	170	115	145	146	9
CMP-L/EW-820-2	322	377	223	369,5	301	68,5	200	247	230	M6	137,5	137	184	213	94,5	189	130	160	156	9
CMP-L/EW-820-4	322	377	223	345,5	277	68,5	200	247	230	M6	137,5	137	184	213	94,5	189	130	160	156	9

CMP-L/EW-922...1025

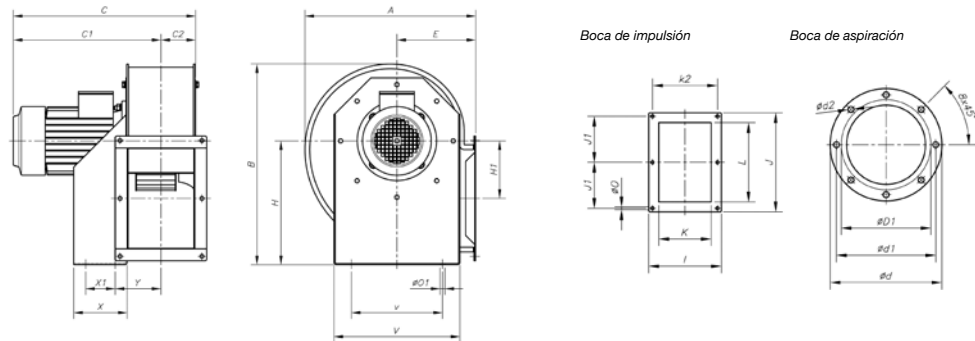

Modelo	A	B	C	C1	C2	øD1*	ød	ød1	ød2	E	H	H1	I	J	J1	K	k2	L	øO	øO1	V	v	X	X1	Y
CMP-L/EW-922-2-1,5	388,5	455	382,5	309	73,5	224	278	256	M8	180	280	134	204	282,5	128	140	180	215	9,5	10,5	290	220	114	50	105
CMP-L/EW-922-2-2	388,5	455	430,5	357	73,5	224	278	256	M8	180	280	134	204	282,5	128	140	180	215	9,5	10,5	290	220	114	50	105
CMP-L/EW-922-2-3	388,5	455	430,5	357	73,5	224	278	256	M8	180	280	134	204	282,5	128	140	180	215	9,5	10,5	290	220	114	50	105
CMP-L/EW-922-4T	388,5	455	382,5	309	73,5	224	278	256	M8	180	280	134	204	282,5	128	140	180	215	9,5	10,5	290	220	114	50	105
CMP-L/EW-1025-2	427	503	456	370	86	250	305	282	M8	197	310	144	229	312,5	145	165	205	250	9,5	12,5	315	228	134	74	115,5
CMP-L/EW-1025-4	427	503	456	370	86	250	305	282	M8	197	310	144	229	312,5	145	165	205	250	9,5	12,5	315	228	134	74	115,5

Orientaciones

Suministro standard LG 270. Posiciones LG 180 y RD 180 bajo demanda y con medidas de anclaje especiales.





Erp. Curvas características y datos Erp

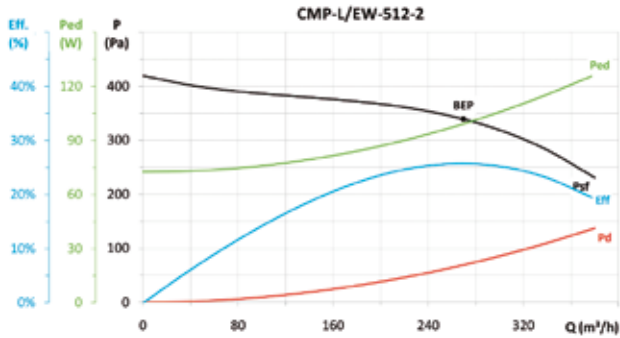

MC	EC	SR	Cc	η_b (%)*	N	[kW]	[m³/h]	[Pa]	[rpm]	VSD
A	S	-	-	-	-	0,099	270	339,2	2850	INCLUDED

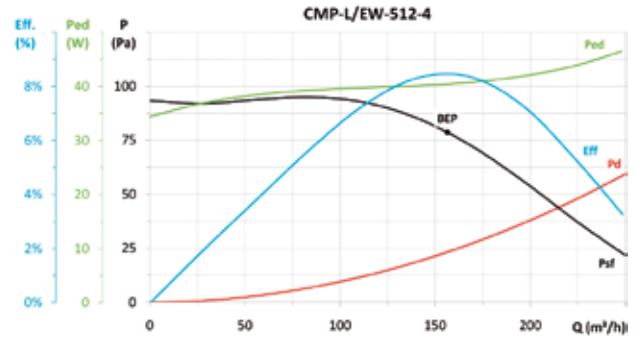

MC	EC	SR	Cc	η_b (%)*	N	[kW]	[m³/h]	[Pa]	[rpm]	VSD
A	S	-	-	-	-	0,040	156	78,7	1410	INCLUDED

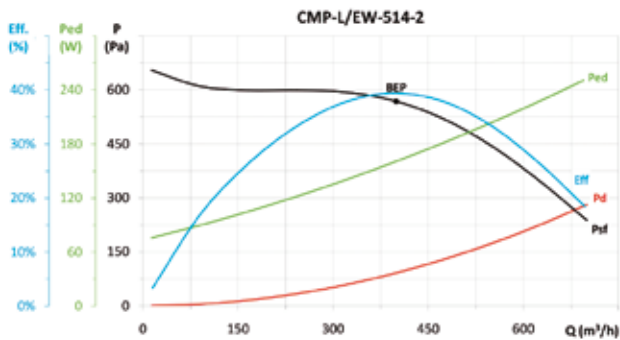

MC	EC	SR	Cc	η_b (%)*	N	[kW]	[m³/h]	[Pa]	[rpm]	VSD
A	S	1,01	1,14	45,0%	56,4	0,160	399	568,1	2850	INCLUDED

* η_e (%) = Eff. (%) x Cc

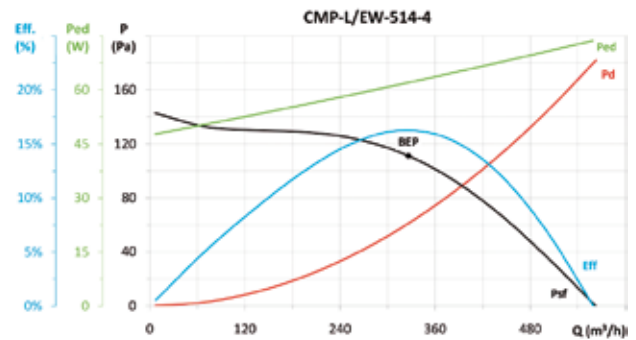

MC	EC	SR	Cc	η_b (%)*	N	[kW]	[m³/h]	[Pa]	[rpm]	VSD
A	S	-	-	-	-	0,062	326	111,2	1410	INCLUDED

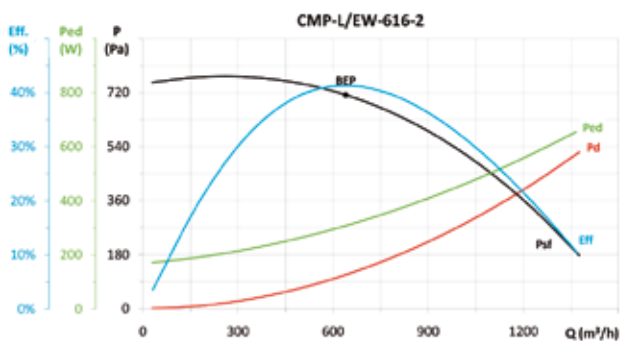

MC	EC	SR	Cc	η_b (%)*	N	[kW]	[m³/h]	[Pa]	[rpm]	VSD
A	S	1,01	1,12	46,4%	56,0	0,306	639	712,3	2850	INCLUDED

* η_e (%) = Eff. (%) x Cc

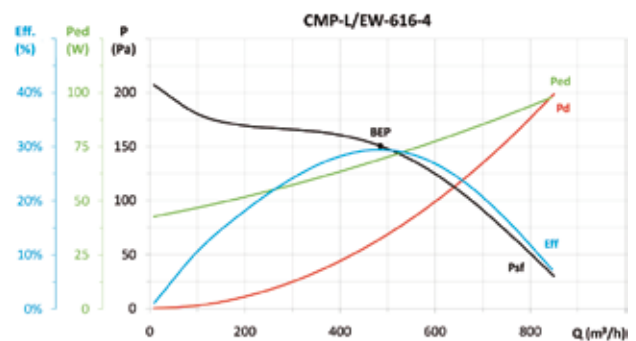

MC	EC	SR	Cc	η_b (%)*	N	[kW]	[m³/h]	[Pa]	[rpm]	VSD
A	S	-	-	-	-	0,069	485	150,6	1410	INCLUDED

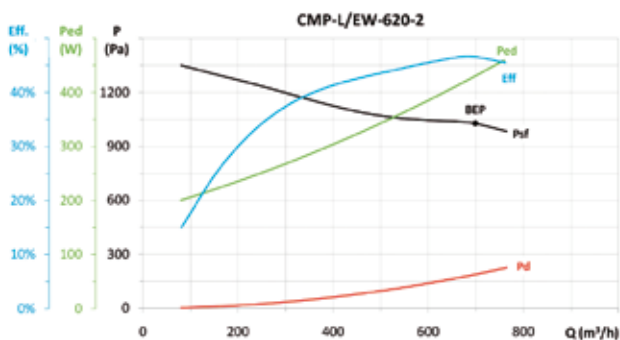

MC	EC	SR	Cc	η_b (%)*	N	[kW]	[m³/h]	[Pa]	[rpm]	VSD
A	S	1,01	1,11	51,9%	60,6	0,428	699	1027,3	2850	INCLUDED

* η_e (%) = Eff. (%) x Cc

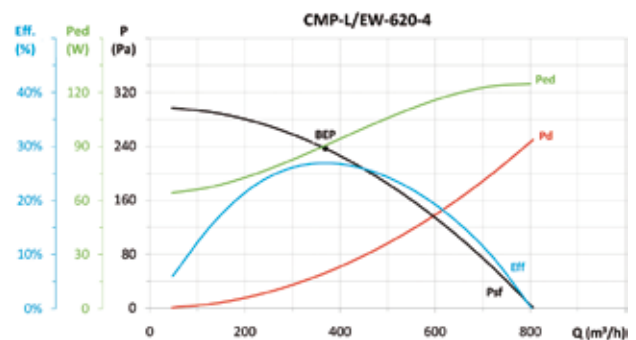

MC	EC	SR	Cc	η_b (%)*	N	[kW]	[m³/h]	[Pa]	[rpm]	VSD
A	S	-	-	-	-	0,090	369	236,7	1410	INCLUDED



EFFICIENT WORK



Erp. Curvas características y datos Erp

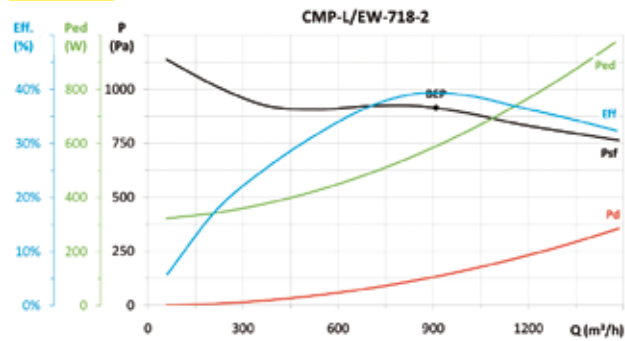

MC	EC	SR	Cc	η_e (%)*	N	[kW]	[m³/h]	[Pa]	[rpm]	VSD
A	S	1,01	1,10	43,5%	51,3	0,586	909	914,0	2850	INCLUDED

* η_e (%) = Eff. (%) x Cc

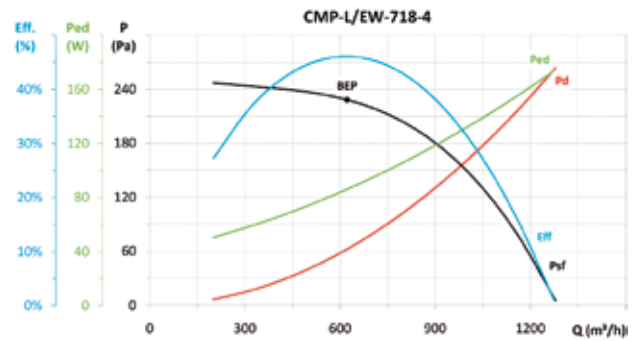

MC	EC	SR	Cc	η_e (%)*	N	[kW]	[m³/h]	[Pa]	[rpm]	VSD
A	S	-	-	-	-	0,086	622	228,3	1410	INCLUDED

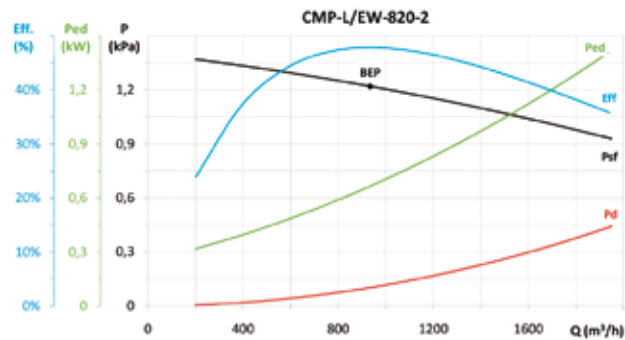

MC	EC	SR	Cc	η_e (%)*	N	[kW]	[m³/h]	[Pa]	[rpm]	VSD
A	S	1,01	1,10	52,6%	60,1	0,662	935	1220,0	2850	INCLUDED

* η_e (%) = Eff. (%) x Cc

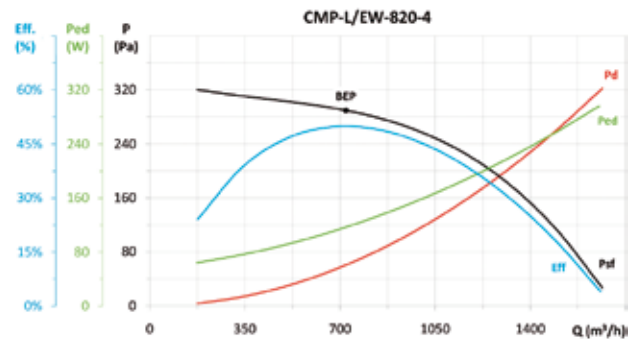

MC	EC	SR	Cc	η_e (%)*	N	[kW]	[m³/h]	[Pa]	[rpm]	VSD
A	S	-	-	-	-	0,116	721	289,6	1410	INCLUDED

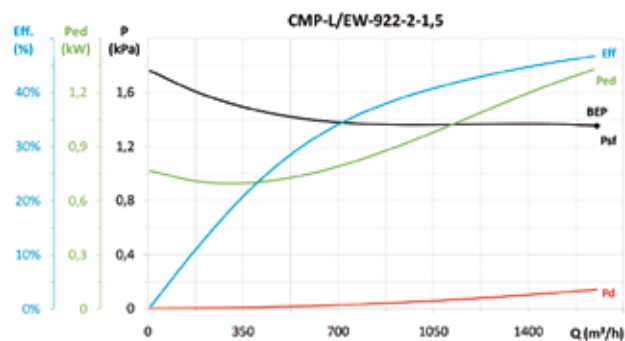

MC	EC	SR	Cc	η_e (%)*	N	[kW]	[m³/h]	[Pa]	[rpm]	VSD
A	S	1,01	1,08	50,5%	56,1	1,328	1652	1354,2	2850	INCLUDED

* η_e (%) = Eff. (%) x Cc

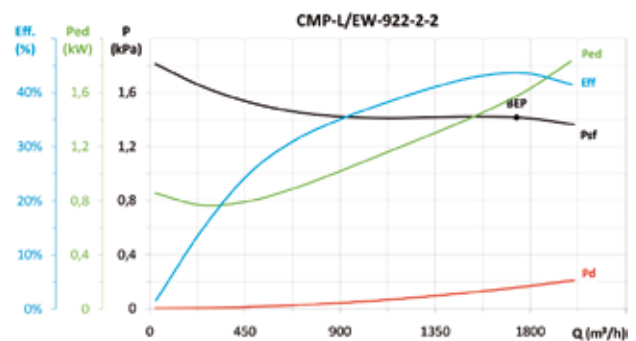

MC	EC	SR	Cc	η_e (%)*	N	[kW]	[m³/h]	[Pa]	[rpm]	VSD
A	S	1,02	1,07	46,9%	52,0	1,563	1736	1416,0	2850	INCLUDED

* η_e (%) = Eff. (%) x Cc

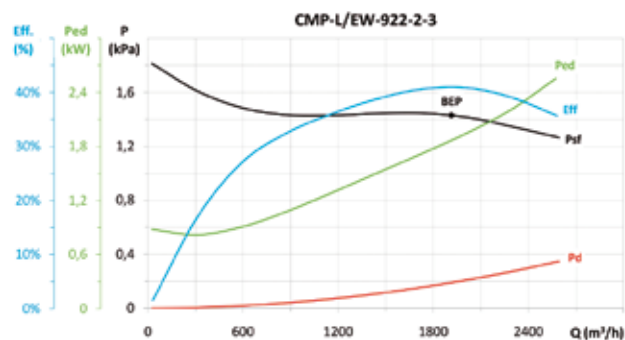

MC	EC	SR	Cc	η_e (%)*	N	[kW]	[m³/h]	[Pa]	[rpm]	VSD
A	S	1,02	1,07	43,8%	48,5	1,855	1915	1429,2	2850	INCLUDED

* η_e (%) = Eff. (%) x Cc

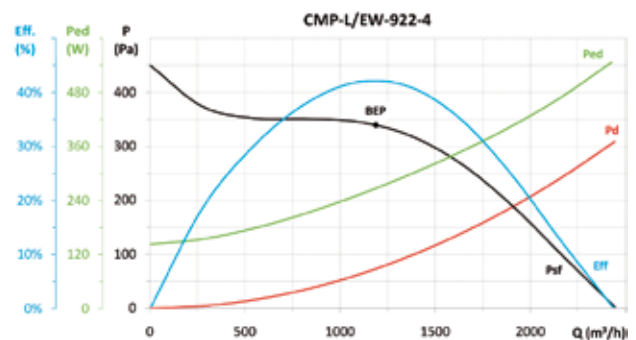

MC	EC	SR	Cc	η_e (%)*	N	[kW]	[m³/h]	[Pa]	[rpm]	VSD
A	S	1,00	1,13	47,6%	57,5	0,265	1187	339,3	1410	INCLUDED

* η_e (%) = Eff. (%) x Cc



Erp. Curvas características y datos ErP

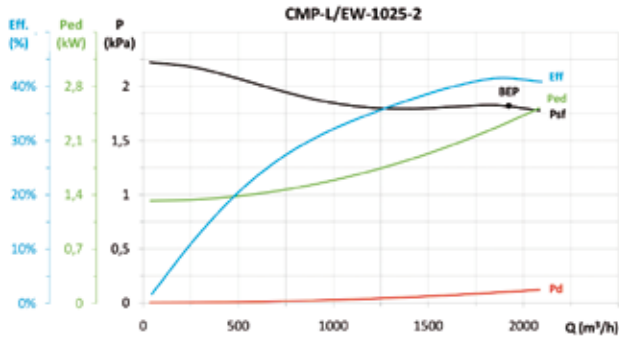

MC	EC	SR	Cc	η_s (%)*	N	[kW]	[m³/h]	[Pa]	[rpm]	VSD
A	S	1,02	1,06	44,2%	48,2	2,337	1923	1821,1	2850	INCLUDED

* η_e (%) = Eff. (%) x Cc

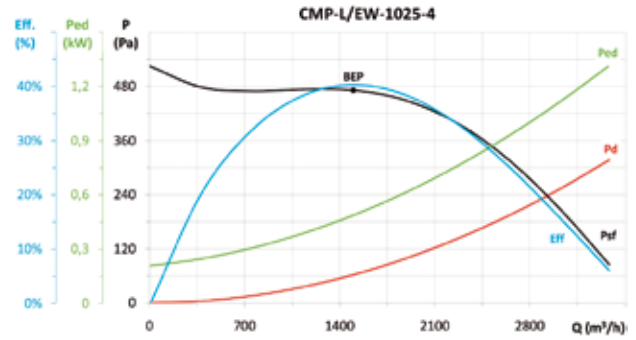

MC	EC	SR	Cc	η_s (%)*	N	[kW]	[m³/h]	[Pa]	[rpm]	VSD
A	S	1,01	1,11	44,7%	53,0	0,488	1501	471,5	1410	INCLUDED

* η_e (%) = Eff. (%) x Cc

Accesorios

Ver apartado accesorios.



INT



RPA



B



BD



BIC



ACE



S



REG



UNIDADES DE CONTROL Y SENSORES

CMP/EW



MOTORES TRIFÁSICOS DE ALTA Eficiencia IE3



VARIADOR VELOCIDAD
VSD: Variador electrónico de velocidad.
VSD1/A-RFM
VSD3/A-RFT
Suministro según pedido



CONTROL
Suministro como accesorio opcional

ALIMENTACIÓN
VSD1/A-RFM:
220-240 V 50/60 Hz
VSD3/A-RFT:
380-415 V 50/60 Hz

Ventiladores centrífugos de media presión y simple aspiración con motor directo y turbina con álabes hacia delante, equipados con motor asíncrono de alta eficiencia IE3 regulable electrónicamente.

Ventilador:

- Envoltente en chapa de acero.
- Turbina con álabes a acción, en chapa de acero de gran robustez.

Motor y variador electrónico:

- Motores eficiencia IE3, regulables electrónicamente.
- Se suministrará el variador de velocidad VSD según pedido.
- Variador electrónico de velocidad (VSD) regulable mediante señal externa de 0-10 V.
- Se recomienda instalar filtros senoidales entre ventilador y variador electrónico de velocidad (VSD), cuando haya gran distancia entre ellos.
- Variador electrónico de velocidad (VSD), disponibles con entrada monofásica 220-240 V 50/60 Hz hasta 3cv (Tipo VSD1/A-RFM) o con entrada trifásica 380-415 V 50/60 Hz (Tipo VSD3/A-RFT).
- Por defecto se entrega el variador electrónico de velocidad (VSD) programado a velocidad constante.
- Temperatura de trabajo ventilador: -25 °C +120 °C.

Temperatura de trabajo (VSD):
-25 °C +50 °C.

- Motores clase F, con rodamientos a bolas, protección IP55.
- Trifásicos 230/400 V 50 Hz (hasta 5,5 CV) y 400/690 V 50 Hz.(potencias superiores a 5,5 CV)

Acabado:

- Anticorrosivo en resina de poliéster polimerizada a 190 °C, previo desengrase con tratamiento nanotecnológico libre de fosfatos.

Bajo demanda:

- Ventilador preparado para transportar aire hasta 250 °C.
- Ventilador en acero inoxidable.

Código de pedido del ventilador

CMP/EW — 1128 — 2T — 4 — IE3

CMP/EW: Ventiladores centrífugos de media presión y simple aspiración con envoltente y turbina en chapa de acero, de alta eficiencia, "Efficient work"

Tamaño turbina

Velocidad máxima:
2T=2950 rpm
4T=1450 rpm
6T=950 rpm

Potencia motor en CV

Motores trifásicos IE3

Código de pedido con suministro de variador electrónico (VSD) incluido

CMP/EW — 1128 — 2T — 4 — IE3 — VSD1 — D

CMP/EW: Ventiladores centrífugos de media presión y simple aspiración con envoltente y turbina en chapa de acero, de alta eficiencia, "Efficient work"

Tamaño turbina

Velocidad máxima:
2T=2950 rpm
4T=1450 rpm
6T=950 rpm

Potencia motor en CV

Motores trifásicos IE3

VSD1: Equipados con VSD1/A-RFM, variador electrónico de velocidad, alimentación monofásica 220-240 V 50/60 Hz.

VSD3: Equipados con VSD3/A-RFT, variador electrónico de velocidad, alimentación trifásica 380-415 V 50/60 Hz.

D: Versión estándar, suministro del VSD programado a velocidad constante.
P: Suministro con VSD programado para control de presión y transmisor de presión Si-Presión
K: Suministro con VSD programado e integrado en una caja BOXPRES KIT para el control de presión. Disponible sólo para ventiladores con potencia motor inferior o igual a 2,2 kW.

Características técnicas

Modelo	Velocidad min/max (r/min)	VSD monofásico 230 V 50/60 Hz		VSD trifásico 400 V 50/60 Hz		Intensidad máxima Motor 50 Hz		Potencia instalada (kW)	Caudal máximo min/max (m ³ /h)	Nivel presión sonora min/max dB(A)	Peso aprox. (Kg)	
		Intensidad máxima entrada (A)	Modelo VSD	Intensidad máxima entrada (A)	Modelo VSD	230V	400V (A)					690V
CMP/EW-1025-2T-4	1165/2910	-	-	7,27	VSD3/A-RFT-5.5	10,00	5,77	-	3,00	1135 / 2830	57 / 77	37,6
CMP/EW-1128-2T-4	1165/2910	-	-	7,27	VSD3/A-RFT-5.5	10,00	5,77	-	3,00	890 / 2220	57 / 77	41,5
CMP/EW-1128-2T-5.5	1160/2900	-	-	9,44	VSD3/A-RFT-5.5	13,00	7,50	-	4,00	1285 / 3210	61 / 81	47,0
CMP/EW-1128-4T	575/1435	23,15	VSD1/A-RFM-3	6,43	VSD3/A-RFT-3	7,93	4,56	-	2,20	2005 / 5000	54 / 74	39,0
CMP/EW-1128-6T	375/940	8,69	VSD1/A-RFM-1	2,41	VSD3/A-RFT-1	3,36	1,93	-	0,75	1315 / 3300	40 / 60	28,5
CMP/EW-1231-4T-3	575/1435	23,15	VSD1/A-RFM-3	6,43	VSD3/A-RFT-3	7,93	4,56	-	2,20	1900 / 4740	53 / 73	47,0
CMP/EW-1231-4T-4	575/1440	-	-	7,20	VSD3/A-RFT-5.5	10,70	6,15	-	3,00	2360 / 5910	55 / 75	49,0
CMP/EW-1231-4T-5.5	580/1450	-	-	9,48	VSD3/A-RFT-5.5	13,90	8,00	-	4,00	2740 / 6850	57 / 77	56,0
CMP/EW-1231-6T	380/950	16,64	VSD1/A-RFM-2	4,62	VSD3/A-RFT-2	6,43	3,70	-	1,50	2045 / 5115	44 / 64	49,0
CMP/EW-1435-4T-4	575/1440	-	-	7,20	VSD3/A-RFT-5.5	10,70	6,15	-	3,00	2220 / 5560	56 / 76	53,0
CMP/EW-1435-4T-5.5	580/1450	-	-	9,48	VSD3/A-RFT-5.5	13,90	8,00	-	4,00	2505 / 6260	58 / 78	61,5
CMP/EW-1435-4T-7.5	585/1465	-	-	12,81	VSD3/A-RFT-7.5	-	10,30	5,97	5,50	2880 / 7210	60 / 80	75,5
CMP/EW-1435-6T	380/950	23,83	VSD1/A-RFM-3	6,62	VSD3/A-RFT-3	9,08	5,22	-	2,20	2560 / 6400	46 / 66	58,5
CMP/EW-1640-4T-5.5	580/1450	-	-	9,48	VSD3/A-RFT-5.5	13,90	8,00	-	4,00	2800 / 7000	57 / 77	78,5
CMP/EW-1640-4T-7.5	585/1465	-	-	12,81	VSD3/A-RFT-7.5	-	10,30	5,97	5,50	3210 / 8035	60 / 80	92,5
CMP/EW-1640-4T-10	585/1465	-	-	17,32	VSD3/A-RFT-10	-	13,90	8,06	7,50	3875 / 9710	62 / 82	103,5
CMP/EW-1640-6T	380/950	23,83	VSD1/A-RFM-3	6,62	VSD3/A-RFT-3	9,08	5,22	-	2,20	3240 / 8100	51 / 71	75,5
CMP/EW-1845-4T-7.5	585/1465	-	-	12,81	VSD3/A-RFT-7.5	-	10,30	5,97	5,50	3195 / 8000	62 / 82	93,5
CMP/EW-1845-4T-10	585/1465	-	-	17,32	VSD3/A-RFT-10	-	13,90	8,06	7,50	3995 / 10000	65 / 85	104,5
CMP/EW-1845-6T	380/950	23,83	VSD1/A-RFM-3	6,62	VSD3/A-RFT-3	9,08	5,22	-	2,20	3000 / 7500	57 / 77	84,0
CMP/EW-2050-4T-10	585/1465	-	-	17,32	VSD3/A-RFT-10	-	13,90	8,06	7,50	3595 / 9000	63 / 83	134,0
CMP/EW-2050-4T-15	590/1470	-	-	25,10	VSD3/A-RFT-15	-	21,40	12,40	11,00	5025 / 12525	67 / 87	153,0
CMP/EW-2050-4T-20	585/1465	-	-	34,41	VSD3/A-RFT-20	-	28,70	16,60	15,00	6590 / 16500	69 / 89	172,0
CMP/EW-2050-6T	580/1450	-	-	9,48	VSD3/A-RFT-5.5	13,90	8,00	-	4,00	4400 / 11000	59 / 79	146,0
CMP/EW-2563-6T	390/975	-	-	34,45	VSD3/A-RFT-20	-	28,00	16,20	15,00	8400 / 21000	66 / 86	251,0

Características acústicas a velocidad máxima

Los valores indicados se determinan mediante medidas de potencia sonora en dB(A) obtenidas en campo libre a una distancia equivalente a dos veces la envergadura del ventilador más el diámetro de la turbina, con un mínimo de 1,5m.

Espectro de potencia sonora Lw(A) en dB(A) banda de frecuencia en [Hz]

Modelo	63	125	250	500	1000	2000	4000	8000	Modelo	63	125	250	500	1000	2000	4000	8000
CMP/EW-1025-2T-4	52	62	73	80	84	81	79	72	CMP/EW-1640-4T-5.5	55	64	75	82	86	84	82	75
CMP/EW-1128-2T-4	52	62	73	80	84	81	79	72	CMP/EW-1640-4T-7.5	58	67	78	85	89	87	85	78
CMP/EW-1128-2T-5.5	56	66	77	84	88	85	83	76	CMP/EW-1640-4T-10	60	69	80	87	91	89	87	80
CMP/EW-1128-4T	49	59	70	77	81	78	76	69	CMP/EW-1640-6T	49	58	69	76	80	78	76	69
CMP/EW-1128-6T	35	45	56	63	67	64	62	55	CMP/EW-1845-4T-7.5	61	71	82	89	93	91	89	81
CMP/EW-1231-4T-3	51	60	71	78	82	80	78	71	CMP/EW-1845-4T-10	64	74	85	92	96	94	92	84
CMP/EW-1231-4T-4	53	62	73	80	84	82	80	73	CMP/EW-1845-6T	56	66	77	84	88	86	84	76
CMP/EW-1231-4T-5.5	55	64	75	82	86	84	82	75	CMP/EW-2050-4T-10	62	72	83	90	94	92	90	82
CMP/EW-1231-6T	42	51	62	69	73	71	69	62	CMP/EW-2050-4T-15	66	76	87	94	98	96	94	86
CMP/EW-1435-4T-4	54	63	74	81	85	83	81	74	CMP/EW-2050-4T-20	68	78	89	96	100	98	96	88
CMP/EW-1435-4T-5.5	56	65	76	83	87	85	83	76	CMP/EW-2050-6T	58	68	79	86	90	88	86	78
CMP/EW-1435-4T-7.5	58	67	78	85	89	87	85	78	CMP/EW-2563-6T	67	77	88	95	99	96	94	87
CMP/EW-1435-6T	44	53	64	71	75	73	71	64									



EFFICIENT WORK



Dimensiones mm

CMP/EW-1025...1231

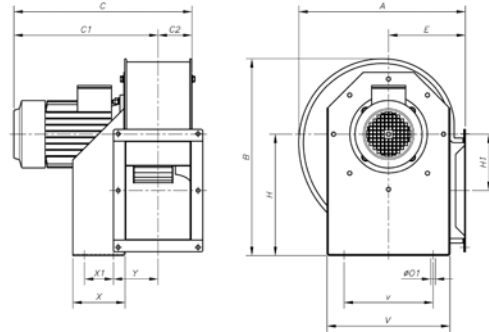

Boca de impulsión

Boca de aspiración

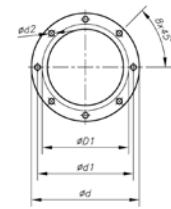
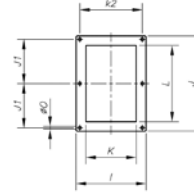

CMP/EW-1435...2563

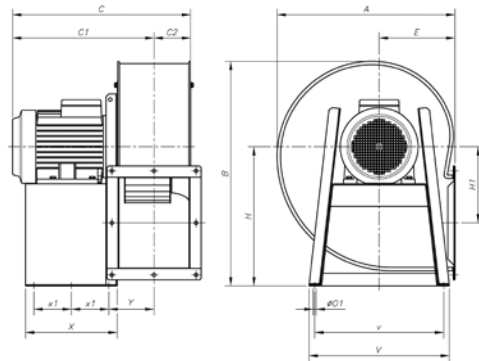

Boca de impulsión

Boca de aspiración

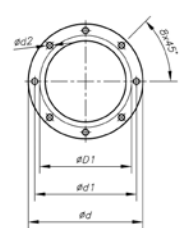
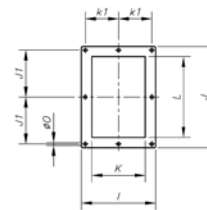

Modelo	A	B	C	C1	C2	ØD1*	Ød	Ød1	Ød2	E	H	H1	I	J	J1	K	k1	k2	L	ØO	ØO1	V	v	X	X1	Y
CMP/EW-1025-2T-4	427	503	486	400	86	250	305	282	M8	197	310	144	229	312,5	145	165	-	205	250	9,5	12,5	315	228	134	74	115,5
CMP/EW-1128-2T-4	472	553	500,5	407	93,5	280	348	320	M8	216	340	152	244	364	170	180	-	220	296,5	9,5	12,5	348	245	144	95	122,5
CMP/EW-1128-2T-5.5	472	553	523,5	430	93,5	280	348	320	M8	216	340	152	244	364	170	180	-	220	296,5	9,5	12,5	348	245	144	95	122,5
CMP/EW-1128-4T	472	553	500,5	407	93,5	280	348	320	M8	216	340	152	244	364	170	180	-	220	296,5	9,5	12,5	348	245	144	95	122,5
CMP/EW-1128-6T	472	553	470,5	377	93,5	280	348	320	M8	216	340	152	244	364	170	180	-	220	296,5	9,5	12,5	348	245	144	95	122,5
CMP/EW-1231-4T-3	526	630	520,5	417	103,5	315	382	354	M8	238	390	179,5	264	382,5	180	200	-	240	320	11,5	13	382	322	183	140	126
CMP/EW-1231-4T-4	526	630	520,5	417	103,5	315	382	354	M8	238	390	179,5	264	382,5	180	200	-	240	320	11,5	13	382	322	183	140	126
CMP/EW-1231-4T-5.5	526	630	543,5	440	103,5	315	382	354	M8	238	390	179,5	264	382,5	180	200	-	240	320	11,5	13	382	322	183	140	126
CMP/EW-1231-6T	526	630	520,5	417	103,5	315	382	354	M8	238	390	179,5	264	382,5	180	200	-	240	320	11,5	13	382	322	183	140	126
CMP/EW-1435-4T-4	573,5	715	549	431	118	355	422	394	M8	250	445	242,5	292	342,5	159	228	133	-	280	11,5	12	456	420	333	136,5	150
CMP/EW-1435-4T-5.5	573,5	715	572	454	118	355	422	394	M8	250	445	242,5	292	342,5	159	228	133	-	280	11,5	12	456	420	333	136,5	150
CMP/EW-1435-4T-7.5	573,5	715	610	492	118	355	422	394	M8	250	445	242,5	292	342,5	159	228	133	-	280	11,5	12	456	420	333	136,5	150
CMP/EW-1435-6T	573,5	715	572	454	118	355	422	394	M8	250	445	242,5	292	342,5	159	228	133	-	280	11,5	12	456	420	333	136,5	150
CMP/EW-1640-4T-5.5	634	799	596	465	130	400	464	438	M8	270	495	271	336	404	185	250	150	-	321	11,5	12	500	460	327	133,5	162,5
CMP/EW-1640-4T-7.5	634	799	634	504	130	400	464	438	M8	270	495	271	336	404	185	250	150	-	321	11,5	12	500	460	327	133,5	162,5
CMP/EW-1640-4T-10	634	799	634	504	130	400	464	438	M8	270	495	271	336	404	185	250	150	-	321	11,5	12	500	460	327	133,5	162,5
CMP/EW-1640-6T	634	799	596	466	130	400	464	438	M8	270	495	271	336	404	185	250	150	-	321	11,5	12	500	460	327	133,5	162,5
CMP/EW-1845-4T-7.5	711	901	668	521	147	450	515	485	M8	302	560	305	370	444	202	284	164	-	361	11,5	12	538	502	340	140	179,5
CMP/EW-1845-4T-10	711	901	668	521	147	450	515	485	M8	302	560	305	370	444	202	284	164	-	361	11,5	12	538	502	340	140	179,5
CMP/EW-1845-6T	711	901	630	483	147	450	515	485	M8	302	560	305	370	444	202	284	164	-	361	11,5	12	538	502	340	140	179,5
CMP/EW-2050-4T-10	797	987	700,5	538	162,5	500	565	535	M10	345	610	313	411	544	250	315	182,5	-	451	11,5	12	653	615	435	188	196
CMP/EW-2050-4T-15	797	987	805,5	643	162,5	500	565	535	M10	345	610	313	411	544	250	315	182,5	-	451	11,5	12	653	615	435	188	196
CMP/EW-2050-4T-20	797	987	805,5	643	162,5	500	565	535	M10	345	610	313	411	544	250	315	182,5	-	451	11,5	12	653	615	435	188	196
CMP/EW-2050-6T	797	987	700,5	538	162,5	500	565	535	M10	345	610	313	411	544	250	315	182,5	-	451	11,5	12	653	615	435	188	196
CMP/EW-2563-6T	1027	1213	1016	805	211	630	710	675	M10	460	742	378	512	706	330	410	230	-	600	17	14	590	540	450	200	239

Orientaciones

Suministro standard LG 270. Posiciones LG 180 y RD 180 bajo demanda y con medidas de anclaje especiales.

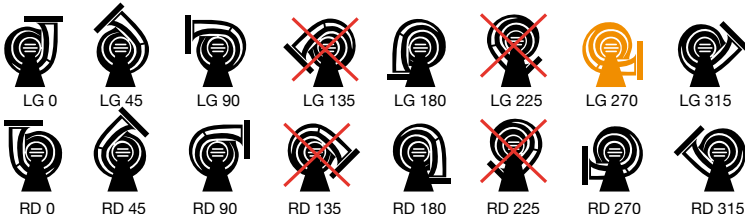



Erp. Curvas características y datos ErP

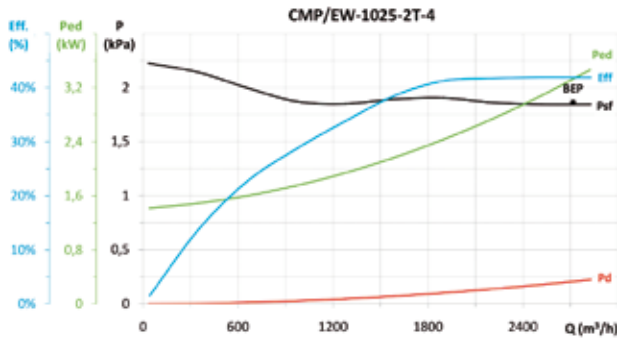

MC	EC	SR	Cc	η_e (%)*	N	[kW]	[m³/h]	[Pa]	[rpm]	VSD
A	S	1,02	1,05	44,5%	47,6	3,320	2717	1862,8	2917	NECESSARY

* η_e (%) = Eff. (%) x Cc

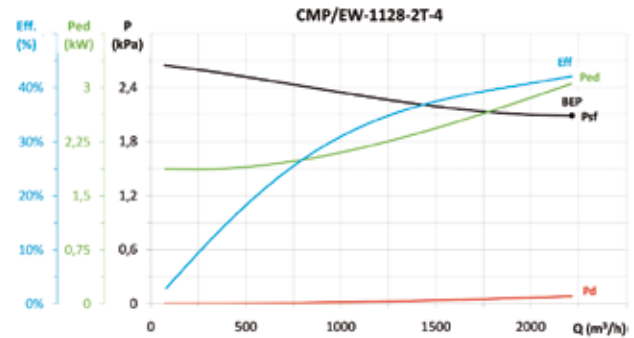

MC	EC	SR	Cc	η_e (%)*	N	[kW]	[m³/h]	[Pa]	[rpm]	VSD
A	S	1,02	1,05	44,4%	47,7	3,054	2216	2089,1	2924	NECESSARY

* η_e (%) = Eff. (%) x Cc

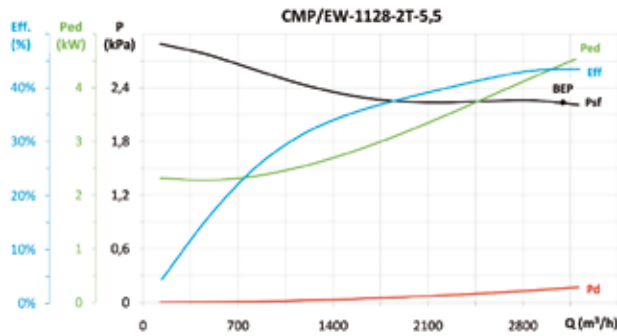

MC	EC	SR	Cc	η_e (%)*	N	[kW]	[m³/h]	[Pa]	[rpm]	VSD
A	S	1,02	1,04	45,5%	47,8	4,409	3095	2236	2906	NECESSARY

* η_e (%) = Eff. (%) x Cc

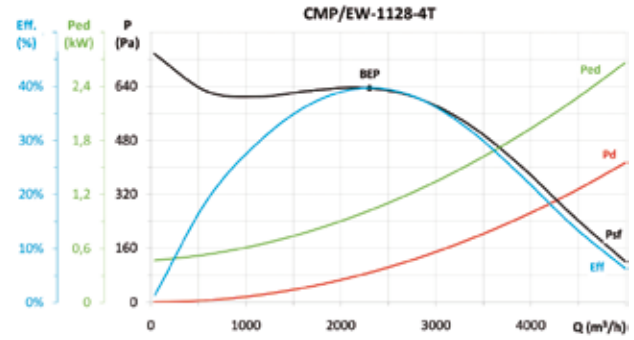

MC	EC	SR	Cc	η_e (%)*	N	[kW]	[m³/h]	[Pa]	[rpm]	VSD
A	S	1,01	1,09	43,2%	49,4	1,022	2303	634,5	1475	NECESSARY

* η_e (%) = Eff. (%) x Cc

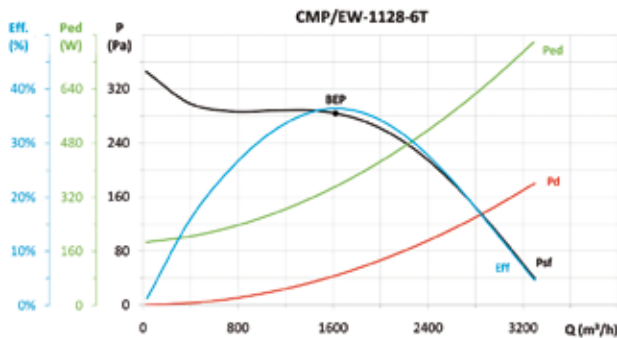

MC	EC	SR	Cc	η_e (%)*	N	[kW]	[m³/h]	[Pa]	[rpm]	VSD
A	S	1,00	1,12	40,7%	49,9	0,351	1622	283,9	979	NECESSARY

* η_e (%) = Eff. (%) x Cc

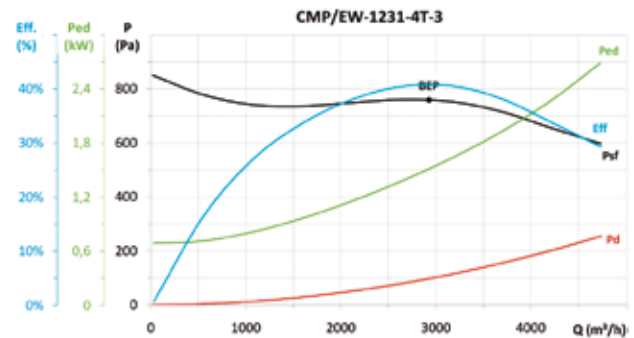

MC	EC	SR	Cc	η_e (%)*	N	[kW]	[m³/h]	[Pa]	[rpm]	VSD
A	S	1,01	1,08	43,9%	49,1	1,512	2927	759,5	1463	NECESSARY

* η_e (%) = Eff. (%) x Cc

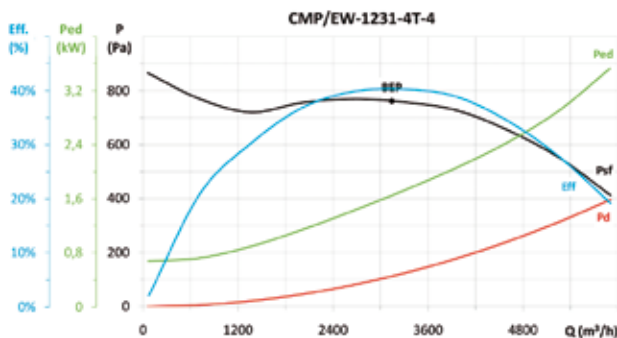

MC	EC	SR	Cc	η_e (%)*	N	[kW]	[m³/h]	[Pa]	[rpm]	VSD
A	S	1,01	1,07	43,2%	48,2	1,650	3143	761,5	1472	NECESSARY

* η_e (%) = Eff. (%) x Cc

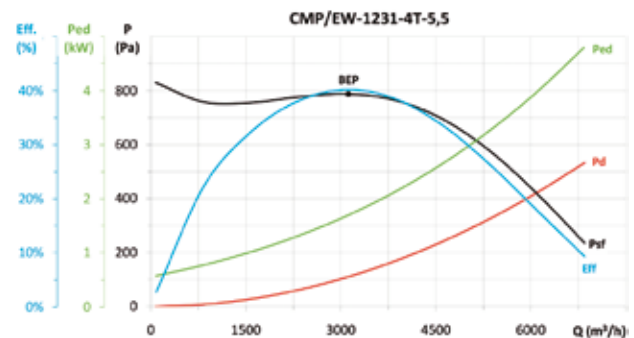

MC	EC	SR	Cc	η_e (%)*	N	[kW]	[m³/h]	[Pa]	[rpm]	VSD
A	S	1,01	1,07	43,1%	47,9	1,699	3120	787,7	1482	NECESSARY

* η_e (%) = Eff. (%) x Cc



EFFICIENT WORK



Erp. Curvas características y datos Erp

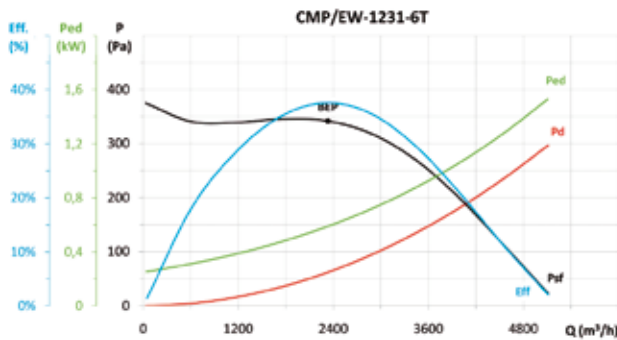

MC	EC	SR	Cc	η_e (%)*	N	[kW]	[m³/h]	[Pa]	[rpm]	VSD
A	S	1,01	1,10	41,5%	49,3	0,589	2332	341,9	985	NECESSARY

* η_e (%) = Eff. (%) x Cc

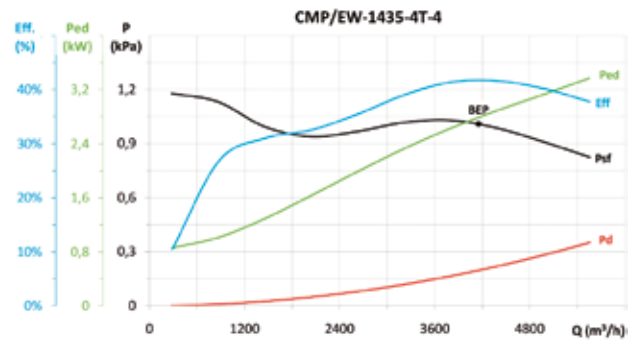

MC	EC	SR	Cc	η_e (%)*	N	[kW]	[m³/h]	[Pa]	[rpm]	VSD
A	S	1,01	1,06	44,2%	47,7	2,788	4153	1009,6	1453	NECESSARY

* η_e (%) = Eff. (%) x Cc

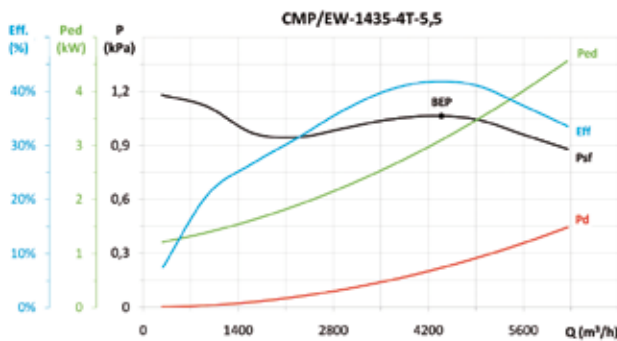

MC	EC	SR	Cc	η_e (%)*	N	[kW]	[m³/h]	[Pa]	[rpm]	VSD
A	S	1,01	1,05	44,1%	47,4	3,099	4394	1062,9	1467	NECESSARY

* η_e (%) = Eff. (%) x Cc

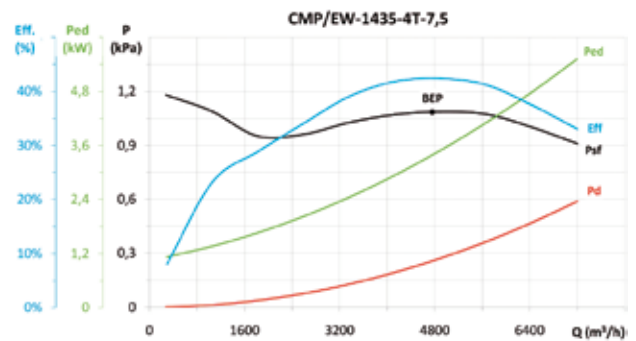

MC	EC	SR	Cc	η_e (%)*	N	[kW]	[m³/h]	[Pa]	[rpm]	VSD
A	S	1,01	1,05	44,6%	47,6	3,384	4761	1084,8	1481	NECESSARY

* η_e (%) = Eff. (%) x Cc

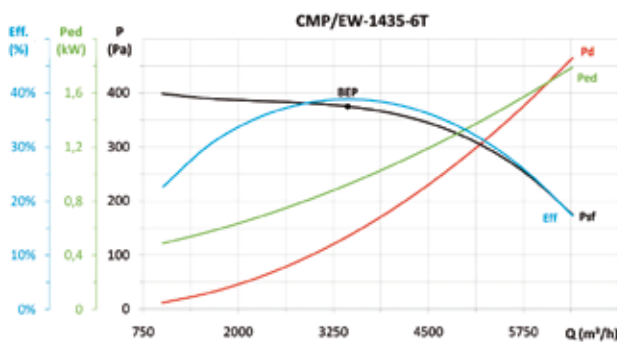

MC	EC	SR	Cc	η_e (%)*	N	[kW]	[m³/h]	[Pa]	[rpm]	VSD
A	S	1,01	1,09	42,3%	48,9	0,923	3441	374,9	983	NECESSARY

* η_e (%) = Eff. (%) x Cc

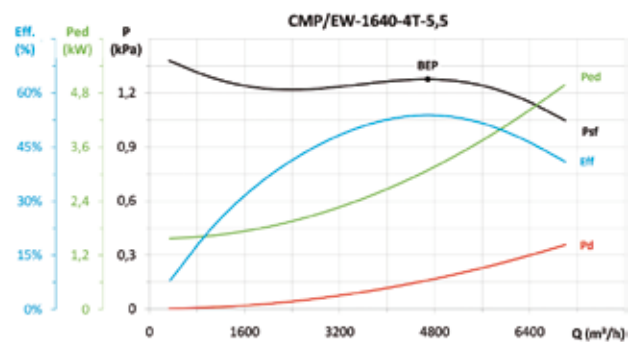

MC	EC	SR	Cc	η_e (%)*	N	[kW]	[m³/h]	[Pa]	[rpm]	VSD
A	S	1,01	1,05	56,8%	60,0	3,084	4685	1276,2	1467	NECESSARY

* η_e (%) = Eff. (%) x Cc

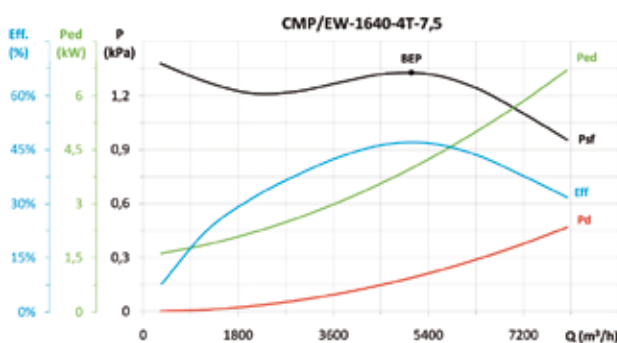

MC	EC	SR	Cc	η_e (%)*	N	[kW]	[m³/h]	[Pa]	[rpm]	VSD
A	S	1,01	1,05	49,2%	51,8	3,982	5080	1327,6	1478	NECESSARY

* η_e (%) = Eff. (%) x Cc

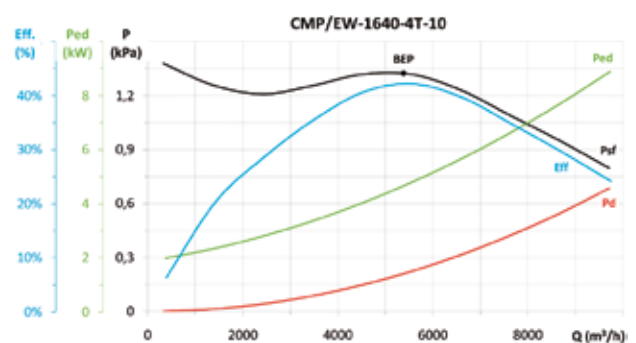

MC	EC	SR	Cc	η_e (%)*	N	[kW]	[m³/h]	[Pa]	[rpm]	VSD
A	S	1,02	1,04	44,0%	46,1	4,690	5382	1324,3	1481	NECESSARY

* η_e (%) = Eff. (%) x Cc



Erp. Curvas características y datos ErP

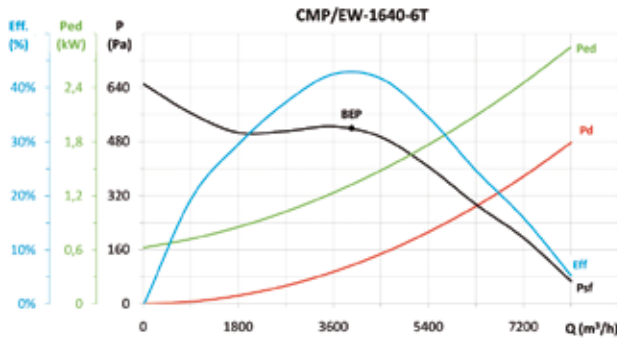

MC	EC	SR	Cc	η_e (%)*	N	[kW]	[m³/h]	[Pa]	[rpm]	VSD
A	S	1,01	1,08	46,5%	52,0	1,324	3946	519,9	976	NECESSARY

* η_e (%) = Eff. (%) x Cc

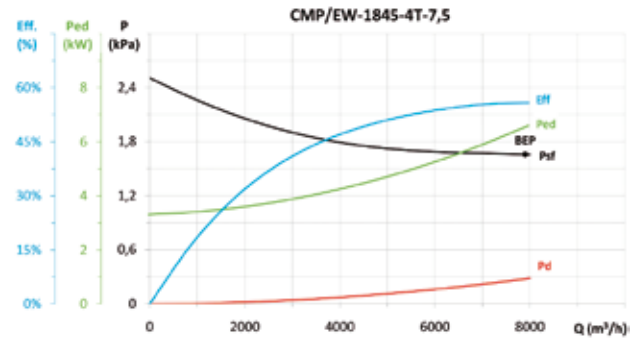

MC	EC	SR	Cc	η_e (%)*	N	[kW]	[m³/h]	[Pa]	[rpm]	VSD
A	S	1,01	1,04	58,1%	59,3	6,521	7900	1659,1	1464	NECESSARY

* η_e (%) = Eff. (%) x Cc

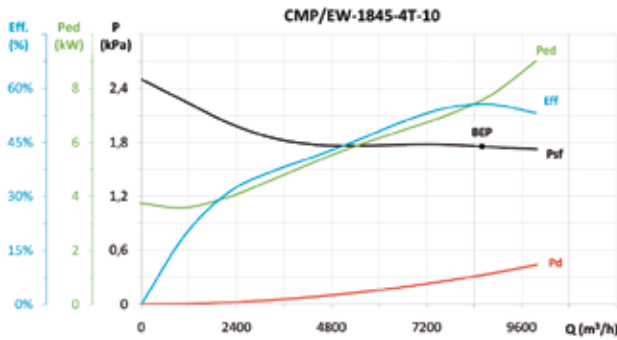

MC	EC	SR	Cc	η_e (%)*	N	[kW]	[m³/h]	[Pa]	[rpm]	VSD
A	S	1,02	1,04	57,8%	58,6	7,538	8599	1754,7	1469	NECESSARY

* η_e (%) = Eff. (%) x Cc

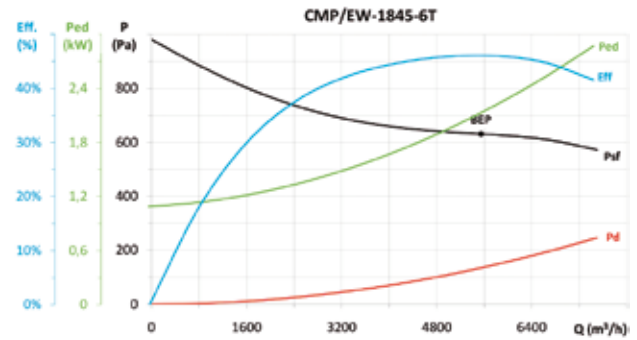

MC	EC	SR	Cc	η_e (%)*	N	[kW]	[m³/h]	[Pa]	[rpm]	VSD
A	S	1,01	1,07	49,1%	53,4	2,109	5546	631,1	962	NECESSARY

* η_e (%) = Eff. (%) x Cc

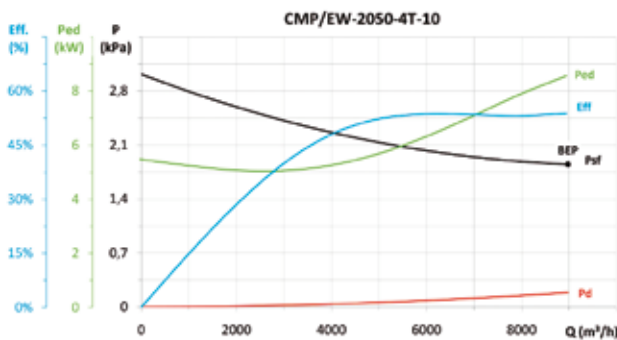

MC	EC	SR	Cc	η_e (%)*	N	[kW]	[m³/h]	[Pa]	[rpm]	VSD
A	S	1,02	1,04	56,0%	56,4	8,565	8977	1847,8	1465	NECESSARY

* η_e (%) = Eff. (%) x Cc

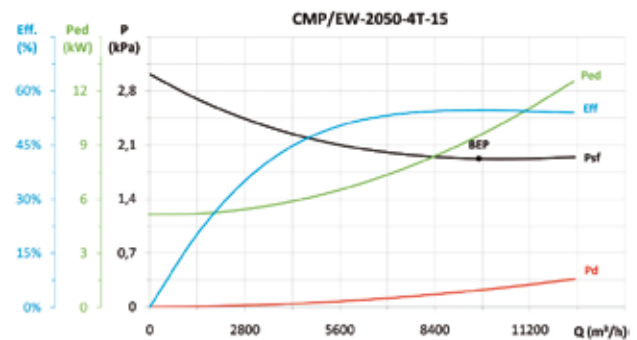

MC	EC	SR	Cc	η_e (%)*	N	[kW]	[m³/h]	[Pa]	[rpm]	VSD
A	S	1,02	1,04	56,8%	57,0	9,478	9695	1921,9	1477	NECESSARY

* η_e (%) = Eff. (%) x Cc

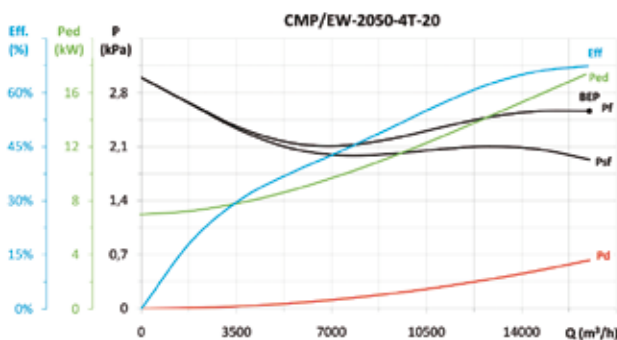

MC	EC	SR	Cc	η_e (%)*	N	[kW]	[m³/h]	[Pa]	[rpm]	VSD
B	T	1,03	1,04	70,1%	69,8	17,416	16500	2561,2	1464	NECESSARY

* η_e (%) = Eff. (%) x Cc

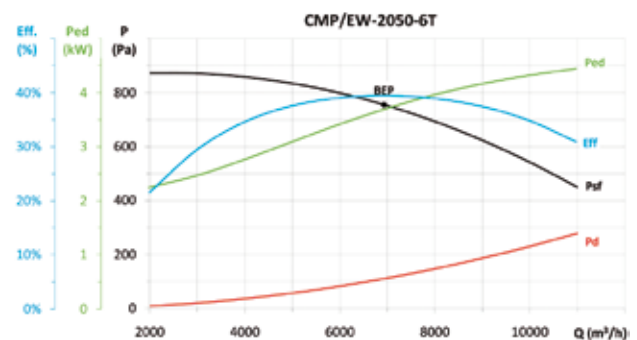

MC	EC	SR	Cc	η_e (%)*	N	[kW]	[m³/h]	[Pa]	[rpm]	VSD
A	S	1,01	1,05	41,4%	44,1	3,684	6929	755,4	1458	NECESSARY

* η_e (%) = Eff. (%) x Cc



EFFICIENT WORK



Erp. Curvas características y datos ErP

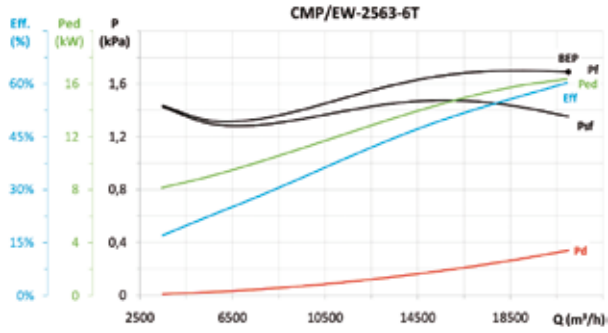

MC	EC	SR	Cc	η_e (%)*	N	[kW]	[m³/h]	[Pa]	[rpm]	VSD
B	T	1,02	1,04	62,7%	62,4	16,362	21000	1691,3	976	NECESSARY

* η_e (%) = Eff. (%) x Cc

Accesorios

Ver apartado accesorios.



INT



VSD1/A-RFM
VSD3/A-RFT



AET



RPA



B



BD



BIC



ACE



S



REG



UNIDADES DE
CONTROL Y SENSORES



CMR-L/EW



VARIADOR VELOCIDAD
VSD: Variador electrónico de velocidad.
- VSD1/B
- VSD3/B

Suministro incluido con el ventilador

CONTROL
Suministro como accesorio opcional

ALIMENTACIÓN
VSD1/B:
220-240 V 50/60 Hz
VSD3/B:
380-415 V 50/60 Hz

Ventiladores centrífugos de media presión y simple aspiración con motor directo y turbina con álabes hacia atrás, equipados con motor Brushless industrial E.C.

Ventilador:

- Envoltorio en chapa de acero.
- Turbina con álabes a reacción, en chapa de acero de gran robustez.
- Variador electrónico de velocidad (VSD), monofásico o trifásico, incluido con el ventilador.

Motor y variador electrónico:

- Motores brushless industriales E.C. de muy alta eficiencia, equipados con variador electrónico de velocidad (VSD), regulable mediante señal externa de control 0-10 V.
- Se recomienda instalar el variador electrónico de velocidad (VSD) fuera de la zona de trabajo.
- La señal externa puede suministrarse a través de un control manual o automático con salida 0-10 V.
- Variador electrónico de velocidad (VSD), disponibles con entrada monofásica 220-240 V 50/60 Hz (Tipo VSD1/B) o trifásica 380-415 V 50/60 Hz (Tipo VSD3/B).

- Por defecto se entrega el variador electrónico de velocidad (VSD) programado a velocidad constante.
- Temperatura de trabajo ventilador: -25 °C +120 °C.
- Temperatura de trabajo (VSD): -25 °C +50 °C.

Acabado:

- Anticorrosivo en resina de poliéster polimerizada a 190 °C, previo desengrase con tratamiento nanotecnológico libre de fosfatos.

Bajo demanda:

- Ventilador en acero inoxidable.

Código de pedido con subministro de variador electrónico (VSD) incluido

CMR-L/EW — 622 — 2 — B — T — D

CMR-L/EW: Ventiladores centrífugos de media presión y simple aspiración, de gran robustez, equipados con turbina con álabes hacia atrás, de alta eficiencia, "Efficient work"

Tamaño turbina

Número de polos:
2=2850 r/min

Motores Brushless industriales E.C.

M: Equipados con VSD1/B, variador electrónico de velocidad, alimentación monofásica 220-240 V 50/60 Hz.

T: Equipados con VSD3/B, variador electrónico de velocidad, alimentación trifásica 380-415 V 50/60 Hz.

D: Versión estándar, suministro del VSD programado a velocidad constante.
P: Suministro con VSD programado para control de presión y transmisor de presión Si-Presión
K: Suministro con VSD programado e integrado en una caja BOXPRES KIT/B para el control de presión.

Características técnicas

Modelo	Velocidad min/max (r/min)	VSD monofásico 230 V 50/60 Hz		VSD trifásico 400 V 50/60 Hz		Potencia eléctrica máxima (W)	Caudal máximo min/max (m³/h)	Nivel presión sonora min/max dB(A)	Peso aprox. (Kg)
		Intensidad máxima entrada (A)	Modelo VSD	Intensidad máxima entrada (A)	Modelo VSD				
CMR-L/EW-622-2	300 / 2850	2,86	VSD1/B-0.37	0,84	VSD3/B-0.75	345	110 / 1040	25 / 74	11,6
CMR-L/EW-625-2	300 / 2850	4,08	VSD1/B-0.37	1,20	VSD3/B-0.75	495	135 / 1280	26 / 75	13,7
CMR-L/EW-728-2	300 / 2850	5,99	VSD1/B-0.37	1,76	VSD3/B-0.75	730	190 / 1800	27 / 76	17,6
CMR-L/EW-731-2	300 / 2850	8,15	VSD1/B-0.75	1,92	VSD3/B-0.75	925	245 / 2350	28 / 77	22,8

Características acústicas a velocidad máxima

Los valores indicados se determinan mediante medidas de potencia sonora en dB(A) obtenidas en campo libre a una distancia equivalente a dos veces la envergadura del ventilador más el diámetro de la turbina, con un mínimo de 1,5m.

Espectro de potencia sonora Lw(A) en dB(A) banda de frecuencia en [Hz]

Modelo	63	125	250	500	1000	2000	4000	8000	Modelo	63	125	250	500	1000	2000	4000	8000
CMR-L/EW-622-2	59	72	72	85	80	80	80	73	CMR-L/EW-728-2	61	74	74	87	82	82	82	75
CMR-L/EW-625-2	60	73	73	86	81	81	81	74	CMR-L/EW-731-2	62	75	75	88	83	83	83	76



EFFICIENT WORK



Dimensiones mm

CMR-L/EW-622...731

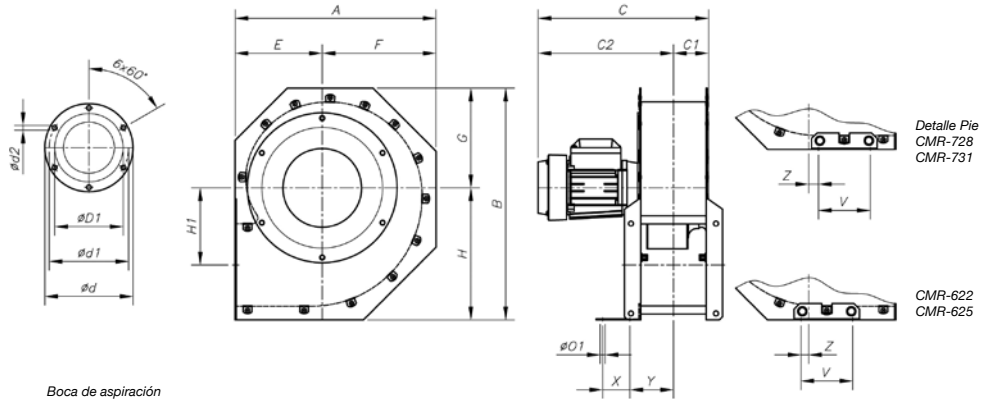

Boca de aspiración

Modelo	A	B	C	C1	C2	$\phi D1^*$	ϕd	$\phi d1$	$\phi d2$	E	F	G	H	H1	$\phi O1$	V	X	Y	Z
CMR-L/EW-622-2	364	415,5	338,5	64	274,5	162	284	256	9,5	160	204	178	237,5	141,5	9	95	50	80	14
CMR-L/EW-625-2	407	457	343,5	66,5	277	160	315	282	9,5	183	224	195,5	261,5	155	9	95	50	82,5	6
CMR-L/EW-728-2	453,5	506,5	357,5	72,5	285	192	354	320	9,5	205	248,5	216	290,5	176	9	95	50	88,2	6,5
CMR-L/EW-731-2	507	564	374	70	304	192	382	354	9,5	230	277	240,5	323,5	197,5	9	95	50	85,2	20,5

* Diámetro nominal tubería recomendada

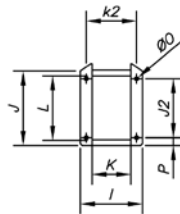

Boca impulsión

Modelo	I	J	J2	K	k2	L	ϕO	S
CMR-L/EW-622-2	180	191,5	165	120	156	150	9	12
CMR-L/EW-625-2	185	207,5	181,5	125	161	167,5	9	12
CMR-L/EW-728-2	196,5	234,5	202	136,5	172,5	187,5	9	12
CMR-L/EW-731-2	190,5	250,5	227,5	130,5	166,5	211	9	12



Erp. Curvas características y datos ErP

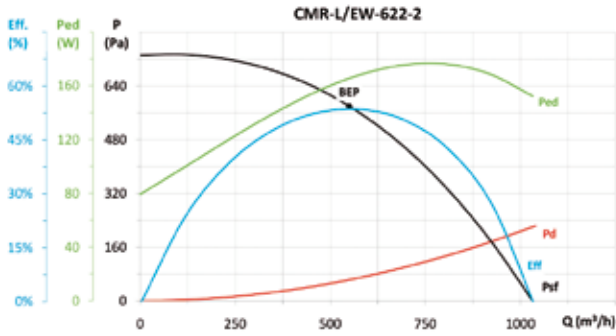

MC	EC	SR	Cc	η_b (%)*	N	[kW]	[m³/h]	[Pa]	[rpm]	VSD
A	S	1,01	1,14	61,2%	79,9	0,165	550	580	2850	INCLUDED

* η_e (%) = Eff. (%) x Cc

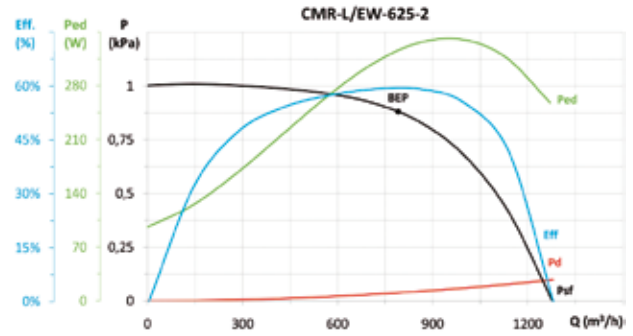

MC	EC	SR	Cc	η_b (%)*	N	[kW]	[m³/h]	[Pa]	[rpm]	VSD
A	S	1,01	1,12	66,7%	82,3	0,325	791	881	2850	INCLUDED

* η_e (%) = Eff. (%) x Cc

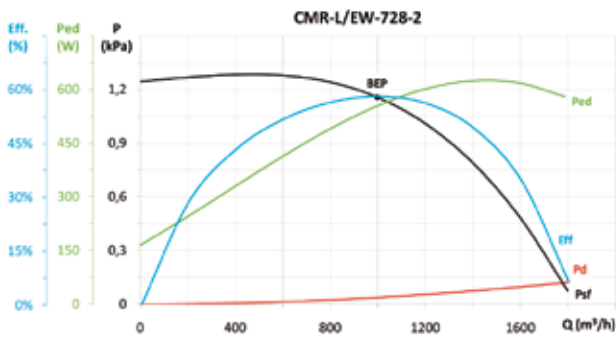

MC	EC	SR	Cc	η_b (%)*	N	[kW]	[m³/h]	[Pa]	[rpm]	VSD
A	S	1,01	1,11	64,2%	77,4	0,552	997	1157	2850	INCLUDED

* η_e (%) = Eff. (%) x Cc

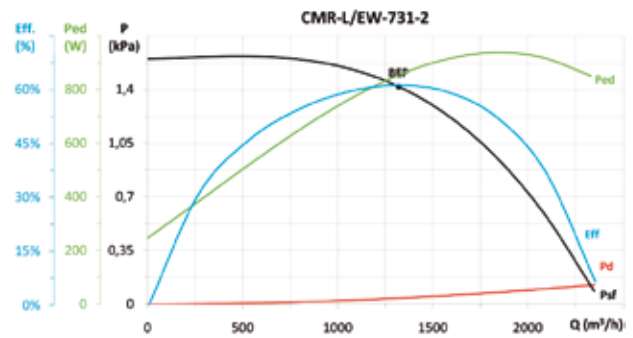

MC	EC	SR	Cc	η_b (%)*	N	[kW]	[m³/h]	[Pa]	[rpm]	VSD
A	S	1,01	1,09	66,9%	78,1	0,851	1320	1419	2850	INCLUDED

* η_e (%) = Eff. (%) x Cc

Accesorios

Ver apartado accesorios.



INT



RPA



B



BD



BIC



ACE



S



REG



UNIDADES DE CONTROL Y SENSORES



EFFICIENT WORK



CMR/EW



MOTORES TRIFÁSICOS DE ALTA Eficiencia IE3



VARIADOR VELOCIDAD
VSD: Variador electrónico de velocidad.
· VSD1/A-RFM
· VSD3/A-RFT
Suministro según pedido

CONTROL
Suministro como accesorio opcional

ALIMENTACIÓN
VSD1/A-RFM:
220-240 V 50/60 Hz
VSD3/A-RFT:
380-415 V 50/60 Hz

Ventiladores centrífugos de media presión y simple aspiración con motor directo y turbina con álabes hacia atrás, equipados con motor asíncrono de alta eficiencia IE3 regulable electrónicamente.

Ventilador:

- Envoltorio en chapa de acero.
- Turbina con álabes a reacción, en chapa de acero de gran robustez.

Motor y variador electrónico:

- Motores eficiencia IE3, regulables electrónicamente.
- Se suministrará el variador de velocidad VSD según pedido.
- Variador electrónico de velocidad (VSD) regulable mediante señal externa de 0-10 V.
- Se recomienda instalar filtros senoidales entre ventilador y variador electrónico de velocidad (VSD), cuando haya gran distancia entre ellos.
- Variador electrónico de velocidad (VSD), disponibles con entrada monofásica 220-240 V 50/60 Hz hasta 3cv (Tipo VSD1/A-RFM) o con entrada trifásica 380-415 V 50/60 Hz (Tipo VSD3/A-RFT).
- Por defecto se entrega el variador electrónico de velocidad (VSD) programado a velocidad constante.
- Temperatura de trabajo ventilador: -25 °C +120 °C.
- Temperatura de trabajo (VSD): -25 °C +50 °C.
- Motores clase F, con rodamientos a bolas, protección IP55.
- Trifásicos 230/400 V 50 Hz (hasta 5,5 CV) y 400/690 V 50 Hz. (potencias superiores a 5,5 CV)

Acabado:

- Anticorrosivo en resina de poliéster polimerizada a 190 °C, previo desengrase con tratamiento nanotecnológico libre de fosfatos.

Bajo demanda:

- Ventilador preparado para transportar aire hasta 250 °C.
- Ventilador en acero inoxidable.

Código de pedido del ventilador

CMR/EW — 1031 — 2T — IE3

CMR/EW: Ventiladores centrífugos de media presión y simple aspiración, de gran robustez, equipados con turbina con álabes hacia atrás, de alta eficiencia, "Efficient work"

Tamaño turbina

Número de polos motor:
2T=2900 r/min
4T=1440 r/min
6T=950 r/min

Motores trifásicos IE3

CMR/EW — 1031 — 2T — IE3 — VSD1 — D

CMR/EW: Ventiladores centrífugos de media presión y simple aspiración, de gran robustez, equipados con turbina con álabes hacia atrás, de alta eficiencia, "Efficient work"

Tamaño turbina

Número de polos motor:
2T=2900 r/min
4T=1440 r/min
6T=950 r/min

Motores trifásicos IE3

VSD1: Equipados con VSD1/A-RFM, variador electrónico de velocidad, alimentación monofásica 220-240 V 50/60 Hz.

VSD3: Equipados con VSD3/A-RFT, variador electrónico de velocidad, alimentación trifásica 380-415 V 50/60 Hz.

D: Versión estándar, suministro del VSD programado a velocidad constante.
P: Suministro con VSD programado para control de presión y transmisor de presión Si-Presión
K: Suministro con VSD programado e integrado en una caja BOXPRES KIT para el control de presión. Disponible sólo para ventiladores con potencia motor inferior o igual a 2,2 kW.

Características técnicas

Modelo	Velocidad min/max (r/min)	VSD monofásico 230 V 50/60 Hz		VSD trifásico 400 V 50/60 Hz		Intensidad máxima Motor 50 Hz			Potencia instalada (kW)	Caudal máximo min/max (m³/h)	Nivel presión sonora min/max dB(A)	Peso aprox. (Kg)		
		Intensidad máxima entrada (A)	Modelo VSD	Intensidad máxima entrada (A)	Modelo VSD	230V	400V (A)	690V						
CMR/EW-1031-2T	1150/2875	16,15	VSD1/A-RFM-2	4,49	VSD3/A-RFT-2	5,34	3,07	-	1,50	2065 / 5160	60 / 80	44,3		
CMR/EW-1135-2T	1165/2910	23,25	VSD1/A-RFM-3	6,46	VSD3/A-RFT-3	7,32	4,21	-	2,20	3125 / 7800	63 / 83	54,9		
CMR/EW-1240-2T	1160/2900	-	-	-	-	9,44	VSD3/A-RFT-5.5	13,00	7,50	-	4,00	4440 / 11100	66 / 86	93,5
CMR/EW-1240-4T	570/1420	8,32	VSD1/A-RFM-1	2,31	VSD3/A-RFT-1	2,82	1,62	-	0,75	2330 / 5800	51 / 71	70,5		
CMR/EW-1445-2T	1175/2935	-	-	17,45	VSD3/A-RFT-10	-	13,90	8,06	7,50	6605 / 16500	67 / 87	126,0		
CMR/EW-1445-4T	580/1455	11,87	VSD1/A-RFM-2	3,30	VSD3/A-RFT-2	4,07	2,34	-	1,10	3200 / 8030	52 / 72	92,5		
CMR/EW-1650-2T	1170/2925	-	-	25,48	VSD3/A-RFT-15	-	19,60	11,40	11,00	7540 / 18850	69 / 89	178,0		
CMR/EW-1650-4T	575/1440	15,78	VSD1/A-RFM-2	4,38	VSD3/A-RFT-2	5,41	3,11	-	1,50	4195 / 10500	54 / 74	114,0		
CMR/EW-1650-6T	375/940	8,69	VSD1/A-RFM-1	2,41	VSD3/A-RFT-1	3,36	1,93	-	0,75	2955 / 7410	44 / 64	114,0		
CMR/EW-1856-4T	575/1440	-	-	7,20	VSD3/A-RFT-5.5	10,70	6,15	-	3,00	6050 / 15150	59 / 79	152,0		
CMR/EW-1856-6T	380/945	12,43	VSD1/A-RFM-2	3,45	VSD3/A-RFT-2	4,68	2,69	-	1,10	4040 / 10050	50 / 70	146,5		
CMR/EW-2063-4T	585/1465	-	-	12,81	VSD3/A-RFT-7.5	-	10,30	5,97	5,50	9765 / 24450	60 / 80	226,0		
CMR/EW-2063-6T	380/950	16,64	VSD1/A-RFM-2	4,62	VSD3/A-RFT-2	6,43	3,70	-	1,50	6440 / 16100	51 / 71	208,5		
CMR/EW-2271-4T	590/1470	-	-	25,10	VSD3/A-RFT-15	-	21,40	12,40	11,00	13890 / 34610	65 / 85	315,0		
CMR/EW-2271-6T	390/970	-	-	7,39	VSD3/A-RFT-5.5	12,00	6,91	-	3,00	9145 / 22750	56 / 76	293,5		
CMR/EW-2380-4T	590/1475	-	-	49,98	VSD3/A-RFT-30	-	40,60	23,50	22,00	19200 / 48000	63 / 83	416,0		
CMR/EW-2380-6T	390/970	-	-	17,59	VSD3/A-RFT-10	-	14,80	8,58	7,50	12060 / 30000	55 / 75	363,0		

Características acústicas a velocidad máxima

Los valores indicados se determinan mediante medidas de potencia sonora en dB(A) obtenidas en campo libre a una distancia equivalente a dos veces la envergadura del ventilador más el diámetro de la turbina, con un mínimo de 1,5m.

Espectro de potencia sonora Lw(A) en dB(A) banda de frecuencia en [Hz]

Modelo	63	125	250	500	1000	2000	4000	8000	Modelo	63	125	250	500	1000	2000	4000	8000
CMR/EW-1031-2T	65	78	78	91	86	86	86	79	CMR/EW-1856-4T	69	78	91	87	90	91	85	71
CMR/EW-1135-2T	72	79	77	89	87	93	92	79	CMR/EW-1856-6T	61	69	81	83	80	81	71	60
CMR/EW-1240-2T	68	83	81	93	90	94	96	83	CMR/EW-2063-4T	80	85	91	93	91	88	81	73
CMR/EW-1240-4T	56	70	76	79	79	80	70	59	CMR/EW-2063-6T	69	70	82	82	81	83	73	63
CMR/EW-1445-2T	73	85	83	95	93	97	99	89	CMR/EW-2271-4T	83	84	93	96	98	99	95	82
CMR/EW-1445-4T	59	72	78	83	80	83	78	64	CMR/EW-2271-6T	73	73	87	86	90	90	79	68
CMR/EW-1650-2T	73	81	85	99	97	99	99	88	CMR/EW-2380-4T	76	78	94	91	96	97	93	82
CMR/EW-1650-4T	64	74	82	84	83	85	76	66	CMR/EW-2380-6T	68	70	86	83	88	89	85	74
CMR/EW-1650-6T	53	65	72	77	73	69	62	54									

Dimensiones mm

CMR/EW-1031...2271

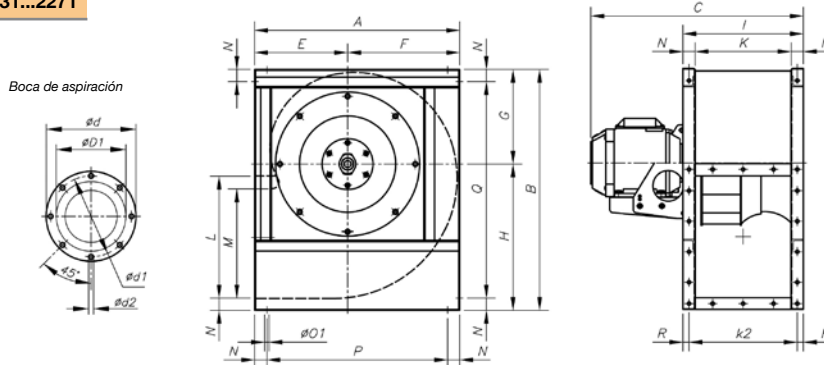

Modelo	A	B	C	øD1*	ød	ød1	ød2	E	F	G	H	I	K	k2	L	M	N	øO1	P	Q	R
CMR/EW-1031-2T	542	626	567	315	383	356	M8	250	292	245	381	320	250	285	315	276	35	11	472	556	17,5
CMR/EW-1135-2T	600	696	583	355	425	398	M8	275	325	273	423	350	280	315	355	310	35	11	530	626	17,5
CMR/EW-1240-2T	673	790	728	400	472	444	M10	305	368	310	480	395	315	355	400	358	40	11	593	710	20
CMR/EW-1240-4T	673	790	590	400	472	444	M10	305	368	310	480	395	315	355	400	358	40	11	593	710	20
CMR/EW-1445-2T	765	880	810	450	522	494	M10	350	415	339	541	445	355	405	450	404	45	11	675	790	20
CMR/EW-1445-4T	765	880	649	450	522	494	M10	350	415	339	541	445	355	405	450	404	45	11	675	790	20
CMR/EW-1650-2T	832	970	961	500	582	555	M10	375	457	378	592	490	400	450	500	445	45	13	742	880	20
CMR/EW-1650-4T	832	970	715	500	582	555	M10	375	457	378	592	490	400	450	500	445	45	13	742	880	20
CMR/EW-1650-6T	832	970	695	500	582	555	M10	375	457	378	592	490	400	450	500	445	45	13	742	880	20
CMR/EW-1856-4T	925	1084	832	560	645	615	M10	415	510	426	658	550	450	500	560	493	50	13	825	984	25
CMR/EW-1856-6T	925	1084	771	560	645	615	M10	415	510	426	658	550	450	500	560	493	50	13	825	984	25
CMR/EW-2063-4T	1037	1218	973	630	720	688	M10	465	572	477	741	620	500	560	630	530	60	13	917	1098	30
CMR/EW-2063-6T	1037	1218	893	630	720	688	M10	465	572	477	741	620	500	560	630	530	60	13	917	1098	30
CMR/EW-2271-4T	1173	1375	1126	710	800	768	M12	525	648	538	837	690	560	625	710	603	65	13	1043	1245	32,5
CMR/EW-2271-6T	1173	1375	1039	710	800	768	M12	525	648	538	837	690	560	625	710	603	65	13	1043	1245	32,5



EFFICIENT WORK



Dimensiones mm

CMR/EW-2380

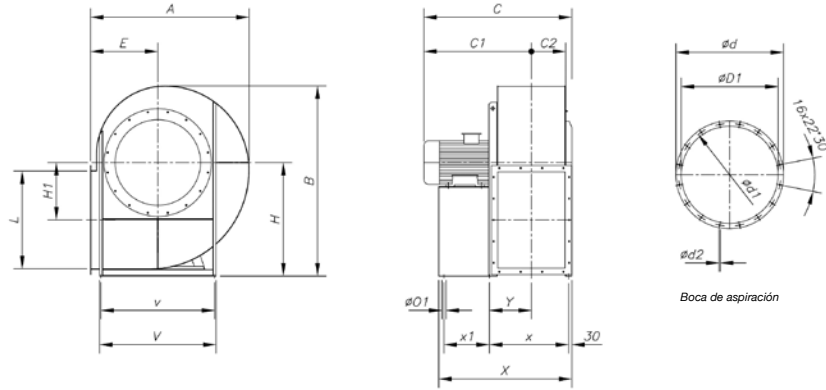

Modelo	A	B	C	C1	C2	ØD1*	Ød	Ød1	Ød2	E	H	H1	L	ØO1	V	v	X	x	x1	Y
CMR/EW-2380-4T	1350	1660	1245	899	286	808	906	861	11,5	560	1000	500	800	17	930	870	1102,5	667,5	370	352,5
CMR/EW-2380-6T	1350	1660	1030	744	286	808	906	861	11,5	56	1000	500	800	17	930	870	1102,5	667,5	370	352,5

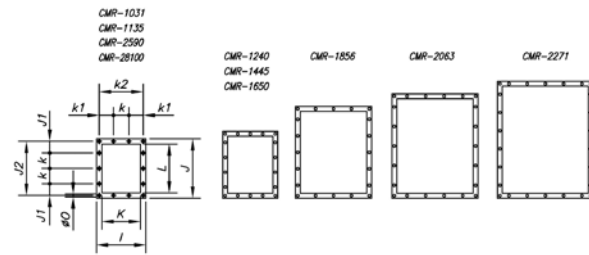

Boca impulsión

Modelo	I	J	J1	J2	K	k	k1	k2	L	ØO
CMR/EW-1031	320	385	75	350	250	100	92,5	285	315	11
CMR/EW-1135	350	425	95	390	280	100	107,5	315	355	11
CMR/EW-1240	395	480	70	440	315	100	77,5	355	400	11
CMR/EW-1445	445	540	99	498	355	100	102,5	405	450	11
CMR/EW-1650	490	590	87,5	550	400	125	100	450	500	13
CMR/EW-1856	550	660	55	610	450	125	125	500	560	13
CMR/EW-2063	620	750	95	690	500	125	92,5	560	630	13
CMR/EW-2271	690	840	75	775	560	125	62,5	625	710	13
CMR/EW-2380	680	920	160	871	560	200	140	639	800	14

Orientaciones

Suministro standard LG 270

Modelos 2380, 2590 y 28100 orientación fija LG 270 (otras orientaciones sólo bajo demanda)





Erp. Curvas características y datos ErP

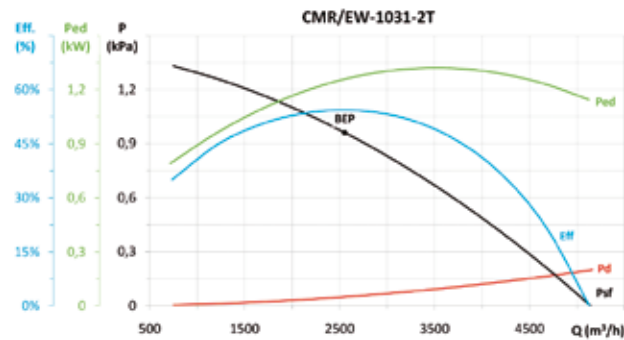

MC	EC	SR	Cc	η_e (%)*	N	[kW]	[m ³ /h]	[Pa]	[rpm]	VSD
A	S	1,01	1,08	58,8%	68,2	1,254	2553	961,3	2916	NECESSARY

* η_e (%) = Eff. (%) x Cc

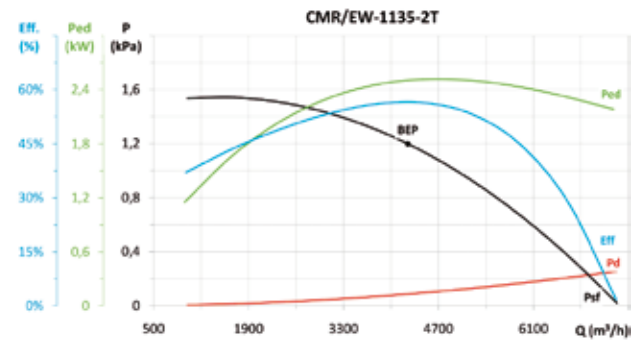

MC	EC	SR	Cc	η_e (%)*	N	[kW]	[m ³ /h]	[Pa]	[rpm]	VSD
A	S	1,01	1,06	60,0%	66,3	2,500	4249	1198,6	2916	NECESSARY

* η_e (%) = Eff. (%) x Cc

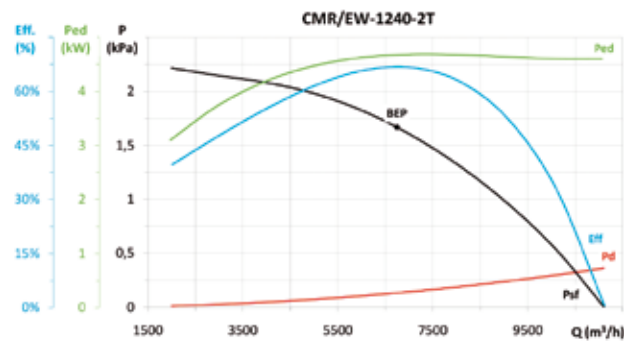

MC	EC	SR	Cc	η_e (%)*	N	[kW]	[m ³ /h]	[Pa]	[rpm]	VSD
A	S	1,02	1,04	69,6%	73,1	4,675	6744	1667,2	2901	NECESSARY

* η_e (%) = Eff. (%) x Cc

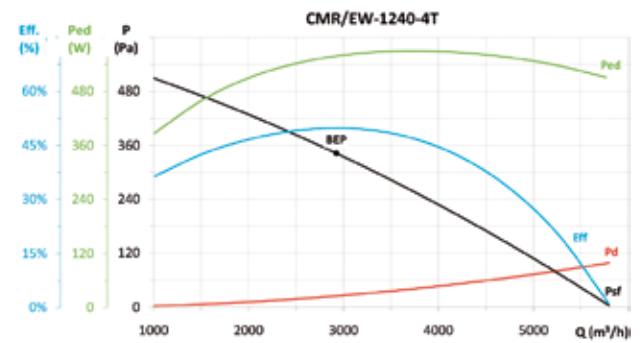

MC	EC	SR	Cc	η_e (%)*	N	[kW]	[m ³ /h]	[Pa]	[rpm]	VSD
A	S	1,00	1,11	55,1%	68,2	0,558	2924	342,3	1453	NECESSARY

* η_e (%) = Eff. (%) x Cc

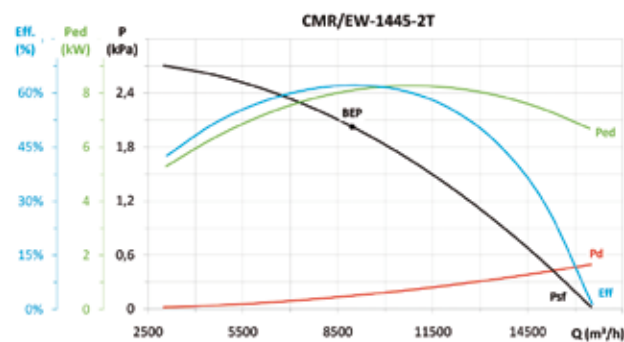

MC	EC	SR	Cc	η_e (%)*	N	[kW]	[m ³ /h]	[Pa]	[rpm]	VSD
A	S	1,02	1,04	64,6%	65,6	8,103	8951	2025,7	2939	NECESSARY

* η_e (%) = Eff. (%) x Cc

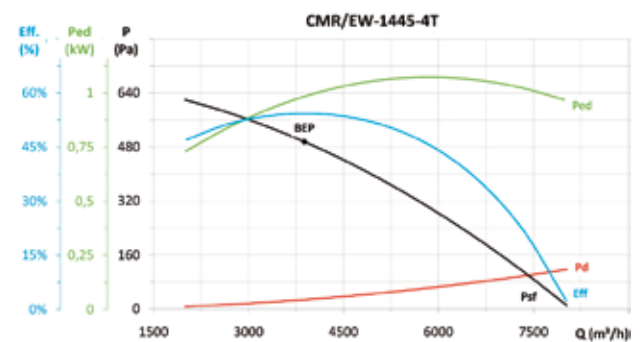

MC	EC	SR	Cc	η_e (%)*	N	[kW]	[m ³ /h]	[Pa]	[rpm]	VSD
A	S	1,01	1,09	59,1%	69,7	0,983	3883	495,3	1468	NECESSARY

* η_e (%) = Eff. (%) x Cc

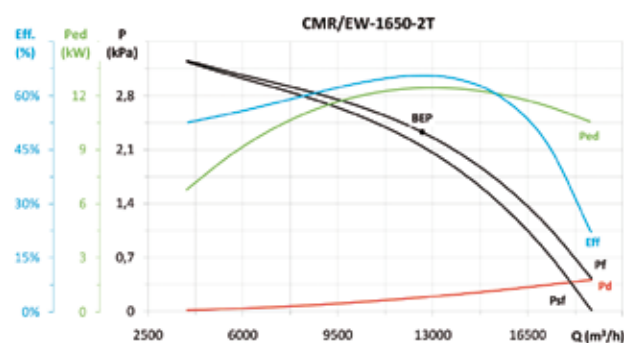

MC	EC	SR	Cc	η_e (%)*	N	[kW]	[m ³ /h]	[Pa]	[rpm]	VSD
B	T	1,02	1,04	68,2%	68,0	12,431	12602	2328,0	2927	NECESSARY

* η_e (%) = Eff. (%) x Cc

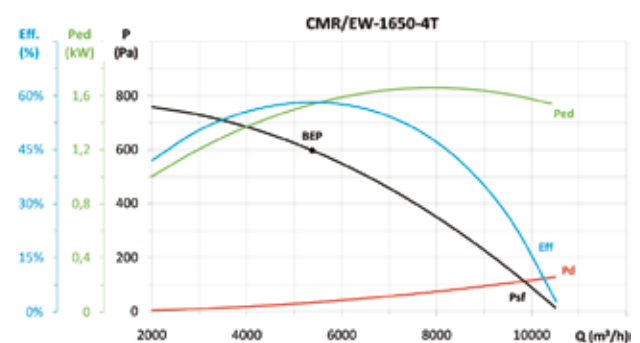

MC	EC	SR	Cc	η_e (%)*	N	[kW]	[m ³ /h]	[Pa]	[rpm]	VSD
A	S	1,01	1,08	62,5%	71,1	1,535	5378	597,4	1449	NECESSARY

* η_e (%) = Eff. (%) x Cc



EFFICIENT WORK



Erp. Curvas características y datos Erp

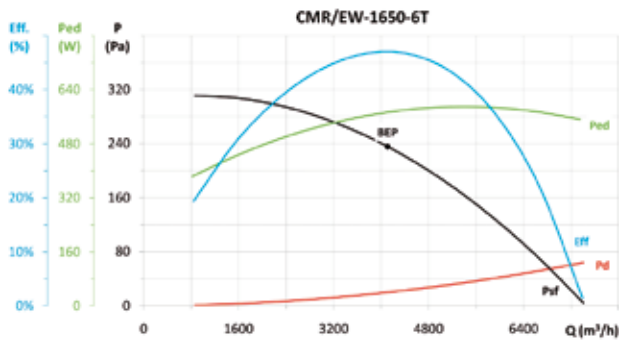

MC	EC	SR	Cc	η_e (%)*	N	[kW]	[m³/h]	[Pa]	[rpm]	VSD
A	S	1,00	1,10	52,0%	65,0	0,572	4109	235,7	966	NECESSARY

* η_e (%) = Eff. (%) x Cc

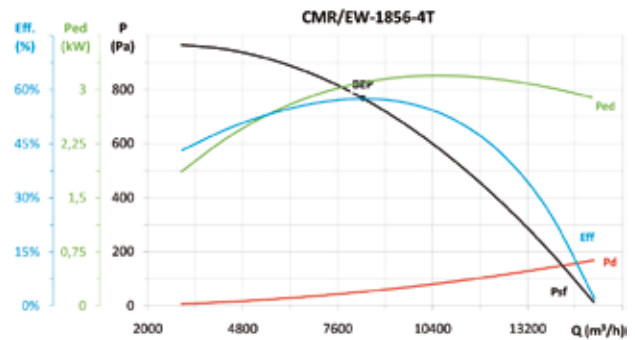

MC	EC	SR	Cc	η_e (%)*	N	[kW]	[m³/h]	[Pa]	[rpm]	VSD
A	S	1,01	1,05	60,6%	65,9	3,096	8342	768,0	1448	NECESSARY

* η_e (%) = Eff. (%) x Cc

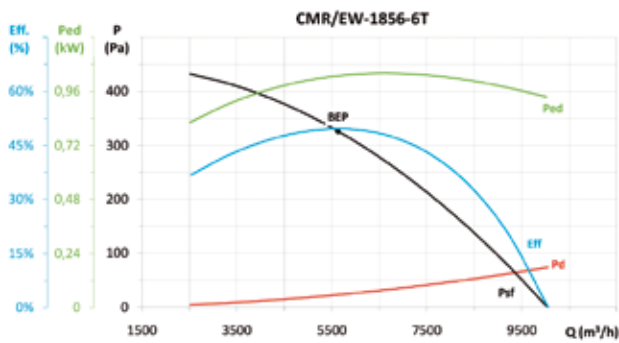

MC	EC	SR	Cc	η_e (%)*	N	[kW]	[m³/h]	[Pa]	[rpm]	VSD
A	S	1,00	1,09	53,9%	64,3	1,028	5632	326,1	960	NECESSARY

* η_e (%) = Eff. (%) x Cc

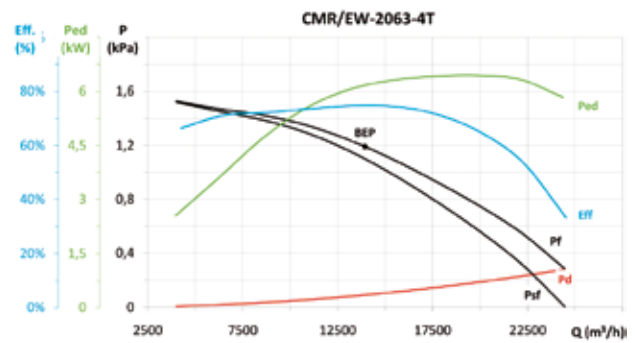

MC	EC	SR	Cc	η_e (%)*	N	[kW]	[m³/h]	[Pa]	[rpm]	VSD
B	T	1,01	1,04	77,8%	80,0	6,161	13932	1190,7	1466	NECESSARY

* η_e (%) = Eff. (%) x Cc

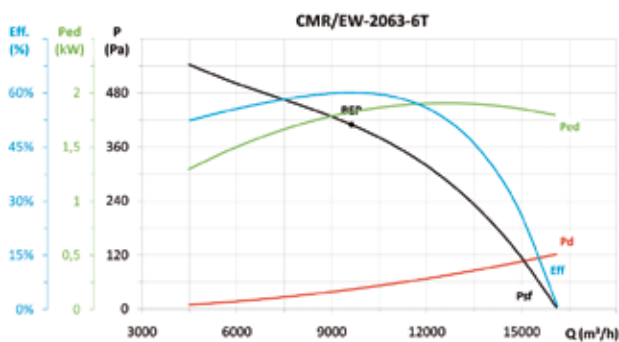

MC	EC	SR	Cc	η_e (%)*	N	[kW]	[m³/h]	[Pa]	[rpm]	VSD
A	S	1,00	1,07	64,3%	72,1	1,822	9620	409,7	952	NECESSARY

* η_e (%) = Eff. (%) x Cc

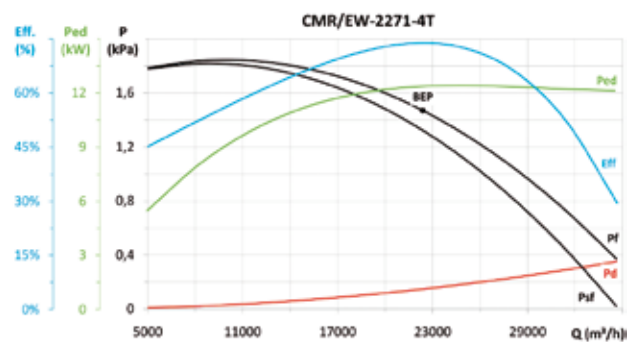

MC	EC	SR	Cc	η_e (%)*	N	[kW]	[m³/h]	[Pa]	[rpm]	VSD
B	T	1,01	1,04	76,8%	76,7	12,369	22380	1469,6	1470	NECESSARY

* η_e (%) = Eff. (%) x Cc

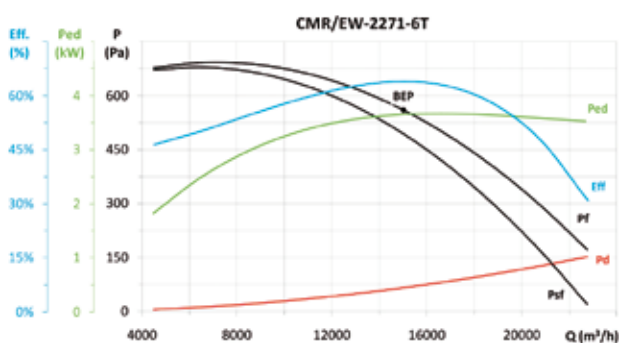

MC	EC	SR	Cc	η_e (%)*	N	[kW]	[m³/h]	[Pa]	[rpm]	VSD
B	T	1,01	1,05	67,1%	71,7	3,654	15016	560,2	970	NECESSARY

* η_e (%) = Eff. (%) x Cc

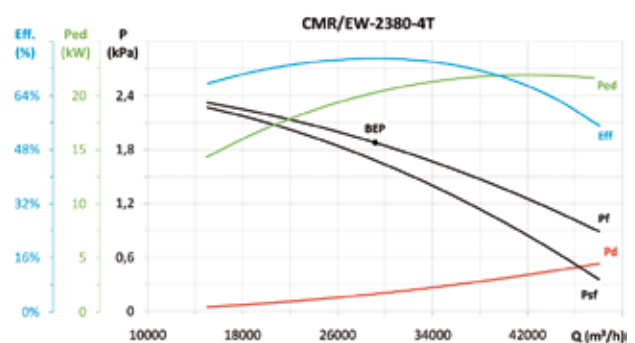

MC	EC	SR	Cc	η_e (%)*	N	[kW]	[m³/h]	[Pa]	[rpm]	VSD
B	T	1,02	1,04	78,0%	77,3	20,266	29151	1877,3	1480	NECESSARY

* η_e (%) = Eff. (%) x Cc



Erp. Curvas características y datos ErP

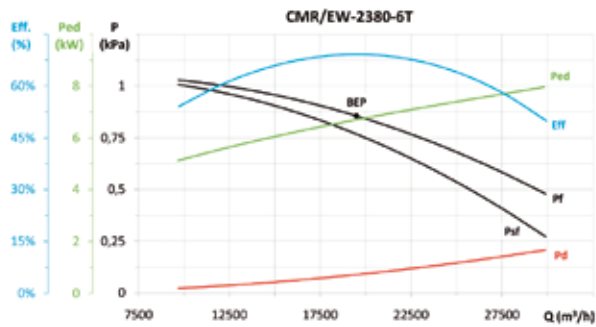

MC	EC	SR	Cc	η_e (%)*	N	[kW]	[m^3/h]	[Pa]	[rpm]	VSD
B	T	1,01	1,04	72,0%	73,8	6,696	19494	855,7	977	NECESSARY

* η_e (%) = Eff. (%) x Cc

Accesorios

Ver apartado accesorios.



INT



VSD1/A-RFM
VSD3/A-RFT



AET



RPA



B



BD



BIC



ACE



S



REG



UNIDADES DE
CONTROL Y SENSORES



EFFICIENT WORK



CAS-L/EW



MOTOR BRUSHLESS INDUSTRIAL E.C.

Ventiladores centrífugos de alta presión y simple aspiración con envolvente en chapa de acero y turbina en aluminio, equipados con motor Brushless industrial E.C.



Ventilador:

- Envolvente en chapa de acero.
- Turbina con álabes hacia atrás de fundición de aluminio.
- Variador electrónico de velocidad (VSD), monofásico o trifásico, incluido con el ventilador.

Motor y variador electrónico:

- Motores brushless industriales E.C. de muy alta eficiencia, equipados con variador electrónico de velocidad (VSD), regulable mediante señal externa de control 0-10 V.
- Se recomienda instalar el variador electrónico de velocidad (VSD) fuera de la zona de trabajo.
- La señal externa puede suministrarse a través de un control manual o automático con salida 0-10 V.
- Variador electrónico de velocidad (VSD), disponibles con entrada monofásica 220-240 V 50/60 Hz (Tipo VSD1/B) o trifásica 380-415 V 50/60 Hz (Tipo VSD3/B).

Por defecto se entrega el variador electrónico de velocidad (VSD) programado a velocidad constante.

- Temperatura de trabajo ventilador: -25 °C +120°C.
- Temperatura de trabajo (VSD): -25 °C +50 °C.

Acabado:

- Anticorrosivo en resina de poliéster polimerizada a 190 °C, previo desengrase con tratamiento nanotecnológico libre de fosfatos.

Bajo demanda:

- Ventilador preparado para transportar aire hasta 250 °C.
- Ventilador en acero inoxidable.
- Silenciador acústico en aspiración.

VARIADOR VELOCIDAD
VSD: Variador electrónico de velocidad.
: VSD1/B
: VSD3/B

Suministro incluido con el ventilador

CONTROL
Suministro como accesorio opcional

ALIMENTACIÓN
VSD1/B:
220-240 V 50/60 Hz
VSD3/B:
380-415 V 50/60 Hz

Código de pedido con suministro de variador electrónico (VSD) incluido

CAS-L/EW — 242 — 2 — 0.33 — B — T — D

CAS-L/EW: Ventiladores centrífugos de alta presión y simple aspiración con envolvente en chapa de acero y turbina en aluminio, de alta eficiencia "Efficient work"

Tamaño turbina

Número de polos motor: 2=2850 r/min

Potencia motor en CV

Motores Brushless industriales E.C.

M: Equipados con VSD1/B, variador electrónico de velocidad, alimentación monofásica 220-240 V 50/60 Hz.

T: Equipados con VSD3/B, variador electrónico de velocidad, alimentación trifásica 380-415 V 50/60 Hz.

D: Versión estándar, suministro del VSD programado a velocidad constante.
P: Suministro con VSD programado para control de presión y transmisor de presión Si-Presión
K: Suministro con VSD programado e integrado en una caja BOXPRES KIT/B para el control de presión.

Características técnicas

Modelo	Velocidad min/max (r/min)	VSD monofásico 230 V 50/60 Hz		VSD trifásico 400 V 50/60 Hz		Potencia eléctrica máxima (W)	Caudal máximo min/max (m³/h)	Nivel presión sonora min/max dB(A)	Peso aprox. (Kg)
		Intensidad máxima entrada (A)	Modelo VSD	Intensidad máxima entrada (A)	Modelo VSD				
CAS-L/EW-242-2-0.33	300 / 2850	2,86	VSD1/B-0.37	0,84	VSD3/B-0.75	345	45 / 450	24 / 73	30,0
CAS-L/EW-242-2-0.5	300 / 2850	4,08	VSD1/B-0.37	1,20	VSD3/B-0.75	495	70 / 650	24 / 73	31,0
CAS-L/EW-248-2-0.75	300 / 2850	5,99	VSD1/B-0.37	1,76	VSD3/B-0.75	730	45 / 420	25 / 74	43,5
CAS-L/EW-248-2-1	300 / 2850	8,15	VSD1/B-0.75	1,92	VSD3/B-0.75	925	55 / 500	26 / 75	45,0
CAS-L/EW-248-2-1.5	300 / 2850	11,80	VSD1/B-0.75	2,78	VSD3/B-1.5	1345	105 / 990	27 / 76	46,5
CAS-L/EW-254-2-1.5	300 / 2850	11,80	VSD1/B-0.75	2,78	VSD3/B-1.5	1345	65 / 600	27 / 76	56,5
CAS-L/EW-254-2-2	300 / 2850	15,89	VSD1/B-1.5	3,74	VSD3/B-1.5	1810	85 / 800	29 / 78	61,5
CAS-L/EW-254-2-3	300 / 2850	23,11	VSD1/B-2.2	5,45	VSD3/B-2.2	2630	135 / 1300	31 / 80	63,0
CAS-L/EW-260-2-3	300 / 2850	23,11	VSD1/B-2.2	5,45	VSD3/B-2.2	2630	95 / 900	30 / 79	78,0

Características acústicas a velocidad máxima

Los valores indicados se determinan mediante medidas de potencia sonora en dB(A) obtenidas en campo libre a una distancia equivalente a dos veces la envergadura del ventilador más el diámetro de la turbina, con un mínimo de 1,5m.

Espectro de potencia sonora Lw(A) en dB(A) banda de frecuencia en [Hz]

Modelo	63	125	250	500	1000	2000	4000	8000	Modelo	63	125	250	500	1000	2000	4000	8000
242-2-0,33	50	61	67	76	83	82	79	72	254-2-1,5	55	66	71	81	88	87	84	77
242-2-0,5	50	61	67	76	83	82	79	72	254-2-2	57	68	73	83	90	89	86	79
248-2-0,75	51	62	68	77	84	83	80	73	254-2-3	56	68	76	85	90	92	89	82
248-2-1	52	63	69	78	85	84	81	74	260-2-2	53	69	69	83	88	88	85	78
248-2-1,5	53	64	70	79	86	85	82	75	260-2-3	55	71	71	85	90	90	87	80

Dimensiones mm

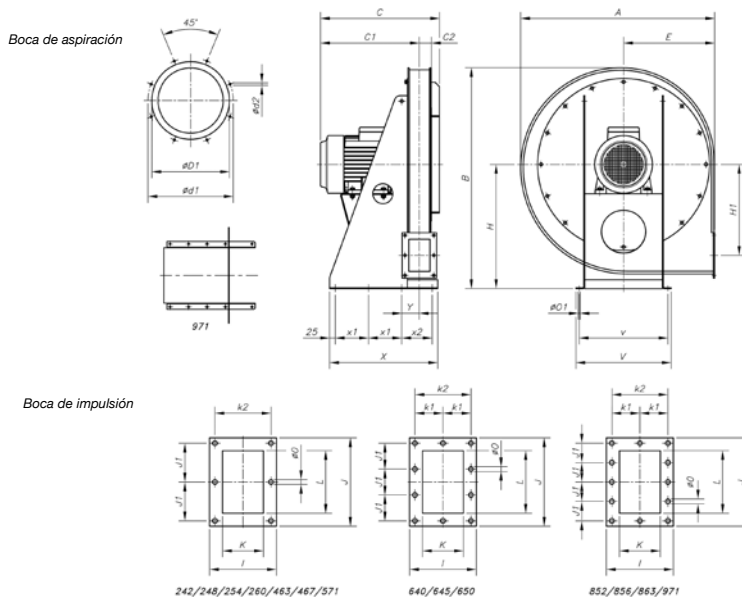

Modelo	A	B	C	C1	C2	øD1	ød1	ød2	E	H	H1	I	J	J1	K	k1	k2	L	øO	øO1	V	v	X	x1	x2	Y
CAS-L/EW-242-2-0,33	576	662	282	219	33	100	130	M8	270	375	270	120	155	65	60	-	95	95	11	12	305	275	260	75	-	61
CAS-L/EW-242-2-0,5	576	662	310	247	33	100	130	M8	270	375	270	120	155	65	60	-	95	95	11	12	305	275	260	75	-	61
CAS-L/EW-248-2-0,75	639	728	315	249	36	112	140	M8	300	410	297	126	165	70	66	-	101	105	11	12	320	290	300	90	-	64
CAS-L/EW-248-2-1	639	728	340	274	36	112	140	M8	300	410	297	126	165	70	66	-	101	105	11	12	320	290	300	90	-	64
CAS-L/EW-248-2-1,5	639	728	340	274	36	112	140	M8	300	410	297	126	165	70	66	-	101	105	11	12	320	290	300	90	-	64
CAS-L/EW-254-2-1,5	699	788	365	294,5	40,5	125	155	M8	330	440	322	135	175	75	75	-	110	115	11	14	340	310	330	100	-	68,5
CAS-L/EW-254-2-2	699	788	413	342,5	40,5	125	155	M8	330	440	322	135	175	75	75	-	110	115	11	14	340	310	330	100	-	68,5
CAS-L/EW-254-2-3	699	788	443	372,5	40,5	125	155	M8	330	440	322	135	175	75	75	-	110	115	11	14	340	310	330	100	-	68,5
CAS-L/EW-260-2-3	782	875	419	343,5	47,5	150	175	M8	370	485	362	145	185	80	85	-	120	125	11	14	380	350	370	115	-	73,5

Orientaciones

Suministro standard LG 270
Posiciones LG 180 bajo demanda
y con medidas de anclaje especiales.



Suministro bajo demanda
Posiciones RD 180 con medidas
de anclaje especiales.





EFFICIENT WORK



Erp. Curvas características y datos ErP

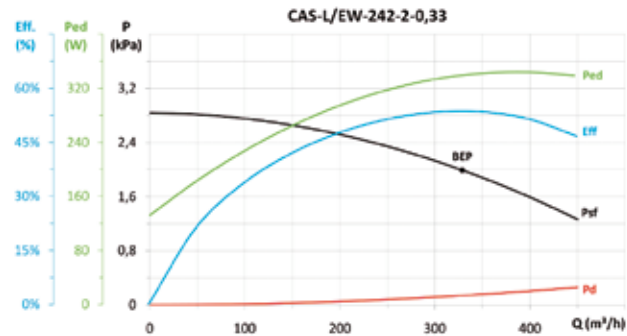

MC	EC	SR	Cc	η_a (%)*	N	[kW]	[m³/h]	[Pa]	[rpm]	VSD
A	S	1,02	1,12	60,1%	75,6	0,339	329	1992	2850	INCLUDED

* η_e (%) = Eff. (%) x Cc

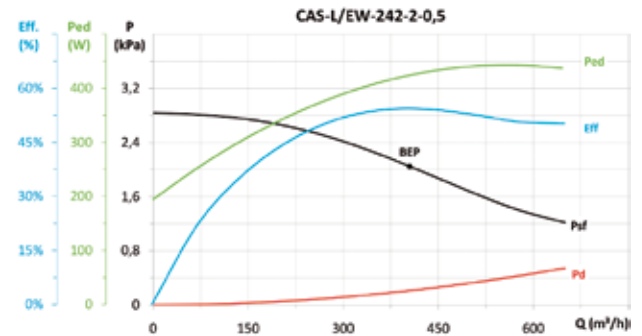

MC	EC	SR	Cc	η_a (%)*	N	[kW]	[m³/h]	[Pa]	[rpm]	VSD
A	S	1,02	1,11	60,6%	75,0	0,423	405	2049	2850	INCLUDED

* η_e (%) = Eff. (%) x Cc

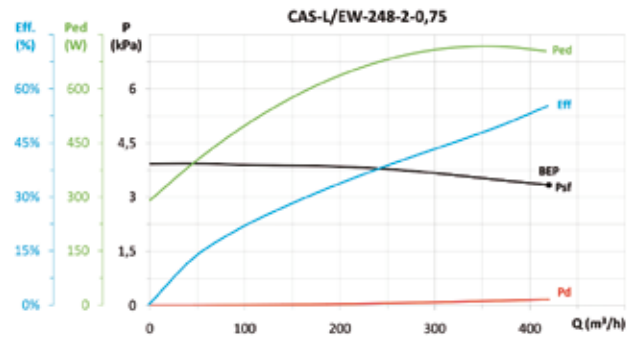

MC	EC	SR	Cc	η_a (%)*	N	[kW]	[m³/h]	[Pa]	[rpm]	VSD
A	S	1,03	1,10	60,7%	72,8	0,704	420	3337,1	2850	INCLUDED

* η_e (%) = Eff. (%) x Cc

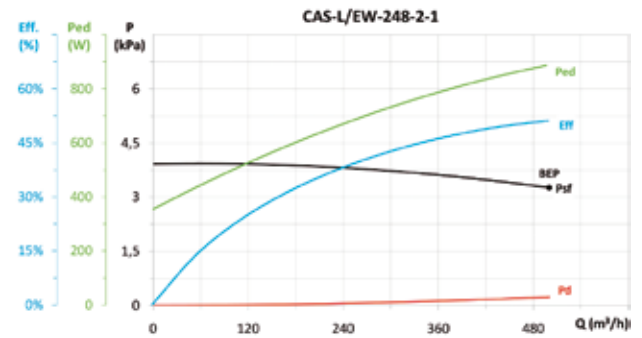

MC	EC	SR	Cc	η_a (%)*	N	[kW]	[m³/h]	[Pa]	[rpm]	VSD
A	S	1,03	1,09	55,8%	66,9	0,886	500	3263,7	2850	INCLUDED

* η_e (%) = Eff. (%) x Cc

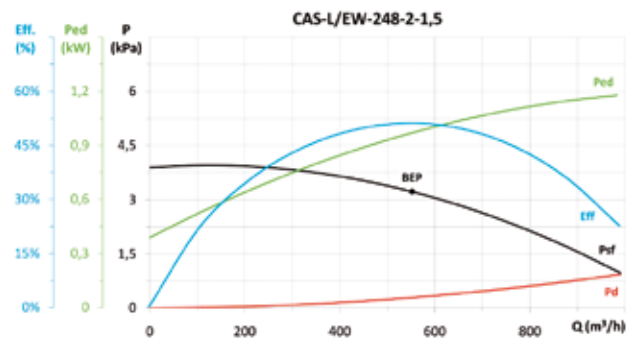

MC	EC	SR	Cc	η_a (%)*	N	[kW]	[m³/h]	[Pa]	[rpm]	VSD
A	S	1,03	1,09	55,7%	66,3	0,966	552	3224,0	2850	INCLUDED

* η_e (%) = Eff. (%) x Cc

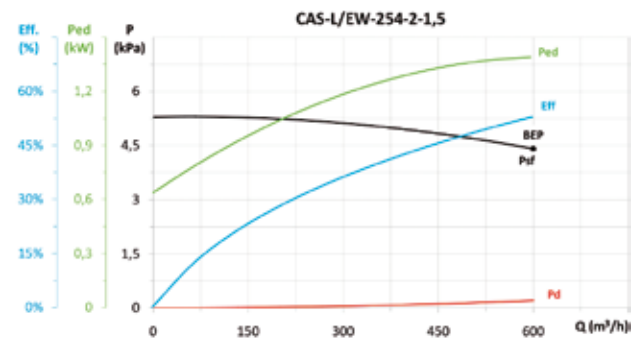

MC	EC	SR	Cc	η_a (%)*	N	[kW]	[m³/h]	[Pa]	[rpm]	VSD
A	S	1,05	1,08	57,0%	66,0	1,390	600	4411,5	2850	INCLUDED

* η_e (%) = Eff. (%) x Cc

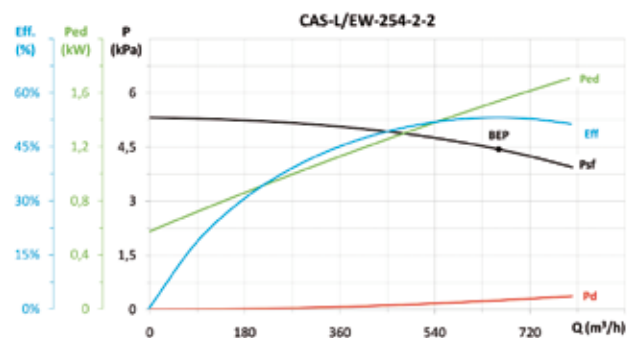

MC	EC	SR	Cc	η_a (%)*	N	[kW]	[m³/h]	[Pa]	[rpm]	VSD
A	S	1,05	1,08	57,1%	65,7	1,534	661	4437,9	2850	INCLUDED

* η_e (%) = Eff. (%) x Cc

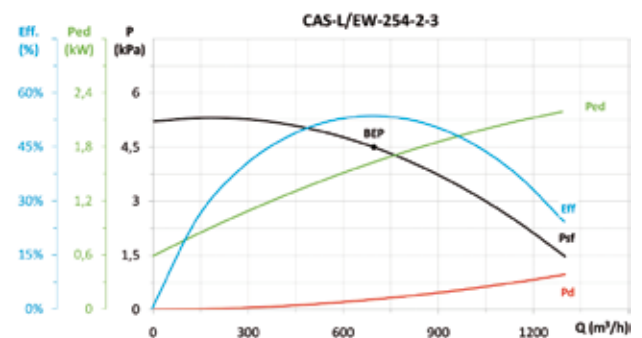

MC	EC	SR	Cc	η_a (%)*	N	[kW]	[m³/h]	[Pa]	[rpm]	VSD
A	S	1,05	1,07	57,5%	65,8	1,624	697	4497,5	2850	INCLUDED

* η_e (%) = Eff. (%) x Cc



Erp. Curvas características y datos ErP

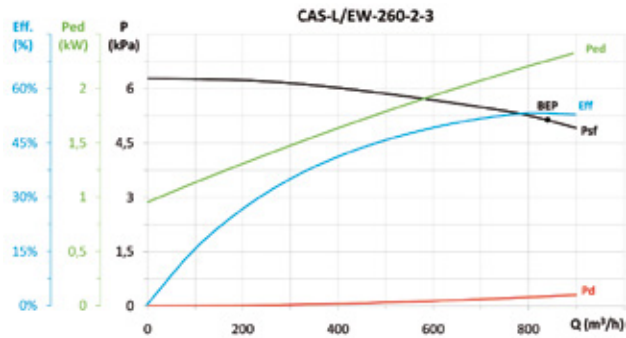

MC	EC	SR	Cc	η_a (%)*	N	[kW]	[m³/h]	[Pa]	[rpm]	VSD
A	S	1,05	1,06	56,7%	63,5	2,250	840	5140,6	2850	INCLUDED

* η_e (%) = Eff. (%) x Cc

Accesorios

Ver apartado accesorios.





EFFICIENT WORK



CAS/EW



MOTORES TRIFÁSICOS DE ALTA Eficiencia IE3



VARIADOR VELOCIDAD
VSD: Variador electrónico de velocidad.
· VSD1/A-RFM
· VSD3/A-RFT
Suministro según pedido

CONTROL
Suministro como accesorio opcional

ALIMENTACIÓN
VSD1/A-RFM:
220-240 V 50/60 Hz
VSD3/A-RFT:
380-415 V 50/60 Hz

Ventiladores centrífugos de alta presión y simple aspiración con envolvente y turbina en chapa de acero, equipados con motor asíncrono de alta eficiencia IE3 regulable electrónicamente.

Ventilador:

- Envolvente en chapa de acero.
- Turbina con álabes a reacción, en chapa de acero galvanizado, excepto modelos 640, 645 y 650 en turbina en fundición de aluminio.

Motor y variador electrónico:

- Motores eficiencia IE3, regulables electrónicamente.
- Se suministrará el variador de velocidad VSD según pedido.
- Variador electrónico de velocidad (VSD) regulable mediante señal externa de 0-10 V.
- Se recomienda instalar filtros senoidales entre ventilador y variador electrónico de velocidad (VSD), cuando haya gran distancia entre ellos.
- Variador electrónico de velocidad (VSD), disponibles con entrada monofásica 220-240 V 50/60 Hz hasta 3cv (Tipo VSD1/A-RFM) o con entrada trifásica 380-415 V 50/60 Hz (Tipo VSD3/A-RFT).
- Por defecto se entrega el variador electrónico de velocidad (VSD) programado a velocidad constante.
- Temperatura de trabajo ventilador: -25 °C +120 °C.
- Temperatura de trabajo (VSD): -25 °C +50 °C.

- Motores clase F, con rodamientos a bolas, protección IP55.
- Trifásicos 230/400 V 50 Hz (hasta 5,5 CV) y 400/690 V 50 Hz (potencias superiores a 5,5 CV).

Acabado:

- Anticorrosivo en resina de poliéster polimerizada a 190 °C, previo desengrase con tratamiento nanotecnológico libre de fosfatos.

Bajo demanda:

- Ventilador preparado para transportar aire hasta 250 °C.
- Ventilador en acero inoxidable.

Código de pedido del ventilador

CAS/EW — 463 — 2T — 5.5 — IE3

CAS/EW: Ventiladores centrífugos de alta presión y simple aspiración con envolvente y turbina en chapa de acero, de alta eficiencia, "Efficient work"

Tamaño turbina

Número de polos motor:
2=2850 r/min

Potencia motor en CV

Motores trifásicos IE3

CAS/EW — 463 — 2T — 5.5 — IE3 — VSD1 — D

CAS/EW: Ventiladores centrífugos de alta presión y simple aspiración con envolvente y turbina en chapa de acero, de alta eficiencia, "Efficient work"

Tamaño turbina

Número de polos motor:
2=2850 r/min

Potencia motor en CV

Motores trifásicos IE3

VSD1: Equipados con VSD1/A-RFM, variador electrónico de velocidad, alimentación monofásica 220-240 V 50/60 Hz.

VSD3: Equipados con VSD3/A-RFT, variador electrónico de velocidad, alimentación trifásica 380-415 V 50/60 Hz.

D: Versión estándar, suministro del VSD programado a velocidad constante.

P: Suministro con VSD programado para control de presión y transmisor de presión Si-Presión
K: Suministro con VSD programado e integrado en una caja BOXPRES KIT para el control de presión. Disponible sólo para ventiladores con potencia motor inferior o igual a 2,2 kW.

Características técnicas

Modelo	Velocidad min/max (r/min)	VSD monofásico 230 V 50/60 Hz		VSD trifásico 400 V 50/60 Hz		Intensidad máxima Motor 50 Hz			Potencia instalada (kW)	Caudal máximo min/max (m³/h)	Nivel presión sonora min/max dB(A)	Peso aprox. (Kg)
		Intensidad máxima entrada (A)	Modelo VSD	Intensidad máxima entrada (A)	Modelo VSD	230V	400V (A)	690V				
CAS/EW-463-2T-5.5	1160/2900	-	-	9,44	VSD3/A-RFT-5.5	13,00	7,50	-	4,00	460 / 1150	62 / 82	57
CAS/EW-463-2T-7.5	1170/2930	-	-	12,91	VSD3/A-RFT-7.5	-	10,10	5,86	5,50	800 / 2000	63 / 83	58
CAS/EW-467-2T-7.5	1170/2930	-	-	12,91	VSD3/A-RFT-7.5	-	10,10	5,86	5,50	620 / 1550	64 / 84	69
CAS/EW-467-2T-10	1175/2935	-	-	17,45	VSD3/A-RFT-10	-	13,90	8,06	7,50	1040 / 2600	65 / 85	70
CAS/EW-571-2T-10	1175/2935	-	-	17,45	VSD3/A-RFT-10	-	13,90	8,06	7,50	800 / 2000	66 / 86	64
CAS/EW-571-2T-15	1170/2925	-	-	25,48	VSD3/A-RFT-15	-	19,60	11,40	11,00	1380 / 3450	67 / 87	65
CAS/EW-640-2T-2	1150/2875	16,15	VSD1/A-RFM-2	4,49	VSD3/A-RFT-2	5,34	3,07	-	1,50	1040 / 2600	57 / 77	56
CAS/EW-645-2T-3	1165/2910	23,25	VSD1/A-RFM-3	6,46	VSD3/A-RFT-3	7,32	4,21	-	2,20	800 / 2000	56 / 76	55
CAS/EW-645-2T-4	1165/2910	-	-	7,27	VSD3/A-RFT-5.5	10,00	5,77	-	3,00	1200 / 3000	61 / 81	55
CAS/EW-650-2T-5.5	1160/2900	-	-	9,44	VSD3/A-RFT-5.5	13,00	7,50	-	4,00	1400 / 3500	61 / 81	59
CAS/EW-650-2T-7.5	1170/2930	-	-	12,91	VSD3/A-RFT-7.5	-	10,10	5,86	5,50	1895 / 4750	63 / 83	52
CAS/EW-852-2T-7.5	1170/2930	-	-	12,91	VSD3/A-RFT-7.5	-	10,10	5,86	5,50	1400 / 3500	61 / 81	68
CAS/EW-852-2T-10	1175/2935	-	-	17,45	VSD3/A-RFT-10	-	13,90	8,06	7,50	2200 / 5500	65 / 85	68
CAS/EW-856-2T-15	1170/2925	-	-	25,48	VSD3/A-RFT-15	-	19,60	11,40	11,00	3000 / 7500	65 / 85	63
CAS/EW-863-2T-15	1170/2925	-	-	25,48	VSD3/A-RFT-15	-	19,60	11,40	11,00	1600 / 4000	64 / 84	67
CAS/EW-863-2T-20	1180/2945	-	-	33,97	VSD3/A-RFT-20	-	27,60	16,00	15,00	2805 / 7000	66 / 86	69
CAS/EW-971-2T-25	1180/2945	-	-	41,67	VSD3/A-RFT-25	-	33,50	19,40	18,50	2325 / 5800	67 / 87	67
CAS/EW-971-2T-30	1180/2955	-	-	49,39	VSD3/A-RFT-30	-	38,80	22,50	22,00	3235 / 8100	68 / 88	68
CAS/EW-1250-2T-15/A	1170/2925	-	-	25,48	VSD3/A-RFT-15	-	19,60	11,40	11,00	4800 / 12000	64 / 84	75
CAS/EW-1456-2T-25/A	1180/2945	-	-	41,67	VSD3/A-RFT-25	-	33,50	19,40	18,50	7210 / 18000	67 / 87	80
CAS/EW-790-2T-20	1180/2945	-	-	33,97	VSD3/A-RFT-20	-	27,60	16,00	15,00	840 / 2100	68 / 88	73
CAS/EW-980-2T-30	1180/2955	-	-	49,39	VSD3/A-RFT-30	-	38,80	22,50	22,00	1915 / 4800	67 / 87	61

Características acústicas a velocidad máxima

Los valores indicados se determinan mediante medidas de potencia sonora en dB(A) obtenidas en campo libre a una distancia equivalente a dos veces la envergadura del ventilador más el diámetro de la turbina, con un mínimo de 1,5m.

Espectro de potencia sonora Lw(A) en dB(A) banda de frecuencia en [Hz]

Modelo	63	125	250	500	1000	2000	4000	8000	Modelo	63	125	250	500	1000	2000	4000	8000
CAS/EW-463-2-5.5	57	69	82	91	93	93	89	80	CAS/EW-852-2-7.5	68	72	82	88	92	92	89	84
CAS/EW-463-2-7.5	58	70	83	92	94	94	90	81	CAS/EW-852-2-10	68	76	86	93	96	96	92	84
CAS/EW-467-2-7.5	69	74	83	95	95	97	93	85	CAS/EW-856-2-15	63	76	90	96	96	94	90	84
CAS/EW-467-2-10	70	75	84	96	96	98	94	86	CAS/EW-863-2-15	67	81	87	96	96	95	92	87
CAS/EW-571-2-10	64	76	86	96	99	99	94	86	CAS/EW-863-2-20	69	81	92	99	98	95	93	87
CAS/EW-571-2-15	65	77	87	97	100	100	95	87	CAS/EW-971-2-25	67	81	90	102	98	96	93	89
CAS/EW-640-2-2	56	67	75	82	88	84	83	76	CAS/EW-971-2-30	68	82	91	103	99	97	94	90
CAS/EW-645-2-3	55	66	74	81	87	83	82	75	CAS/EW-1250-2-15/A	75	88	97	94	91	86	82	73
CAS/EW-645-2-4	55	66	77	86	90	91	87	79	CAS/EW-1456-2-25/A	80	93	102	99	96	90	87	78
CAS/EW-650-2-5.5	59	75	84	90	93	90	85	78	CAS/EW-790-2-20	73	77	88	99	105	96	89	83
CAS/EW-650-2-7.5	52	68	81	91	96	93	85	78	CAS/EW-980-2-30	61	70	76	91	105	97	94	90

Orientaciones

Suministro standard LG 270
Posiciones LG 180 bajo demanda
y con medidas de anclaje especiales.



Suministro bajo demanda
Posiciones RD 180 con medidas
de anclaje especiales.





EFFICIENT WORK



Dimensiones mm

CAS/EW-463...971

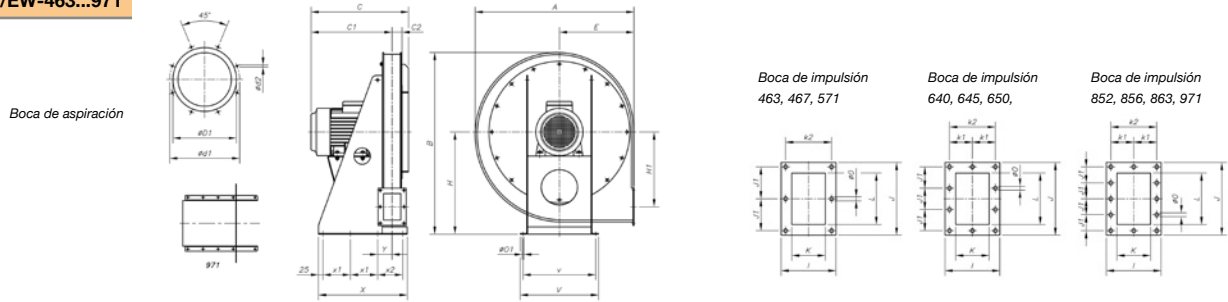

Modelo	A	B	C	C1	ø D1	ø D2	d1	x	ø	B	E	H	H1	I	J	J1	J2	K	K1	L	M	øO1	V	v	X	X1	X2	Y
CAS-463-2T-5,5	782	875	459	383,5	200	M8	240	-	-	370	485	362	145	185	80	-	85	-	125	-	14	380	380	370	115	-	73,5	
CAS-463-2T-7,5	782	875	517	441,5	200	M8	240	-	-	370	485	362	145	185	80	-	85	-	125	-	14	380	380	370	115	-	73,5	
CAS-467-2T-7,5	833	945	530	442	224	M8	258	-	-	390	530	395	150	190	82,5	-	90	-	130	-	14	405	405	300	125	-	76	
CAS-467-2T-10	833	945	530	442	224	M8	258	-	-	390	530	395	150	190	82,5	-	90	-	130	-	14	405	405	300	125	-	76	
CAS-571-2T-10	873	995	536	445,5	250	M8	275	-	-	410	560	410	155	205	90	-	95	-	145	-	14	430	430	350	150	-	79,5	
CAS-571-2T-15	873	995	671	580,5	250	M8	275	-	-	410	560	410	155	205	90	-	95	-	145	-	14	430	430	410	180	-	79,5	
CAS-640-2T-2	639	728	446	350,5	250	M8	275	-	-	300	410	250	185	260	78	-	125	80	200	-	14	340	340	350	100	-	93,5	
CAS-645-2T-3	699	788	461	358	250	M8	275	-	-	330	440	267,5	200	284	86	-	140	87,5	224	-	14	380	380	380	115	-	101	
CAS-645-2T-4	699	788	491	388	250	M8	275	-	-	330	440	267,5	200	284	86	-	140	87,5	224	-	14	380	380	380	115	-	101	
CAS-650-2T-5,5	782	875	534	421	250	M8	275	-	-	370	485	300	220	310	95	-	160	97,5	250	-	14	405	405	490	125	190	111	
CAS-650-2T-7,5	782	875	572	459	250	M8	275	-	-	370	485	300	220	310	95	-	160	97,5	250	-	14	405	405	490	125	190	111	
CAS-852-2T-7,5	833	945	603	470	380	M8	310	-	-	390	530	320	240	340	78	-	180	107,5	280	-	14	430	430	540	150	190	122	
CAS-852-2T-10	833	945	603	470	380	M8	310	-	-	390	530	320	240	340	78	-	180	107,5	280	-	14	430	430	540	150	190	122	
CAS-856-2T-15	833	945	708	575	355	M8	395	-	-	390	530	320	240	340	78	-	180	107,5	280	-	14	430	430	600	180	190	122	
CAS-863-2T-15	873	995	728	585	355	M8	410	-	-	410	560	325	260	375	87,5	-	200	117,5	315	-	14	430	430	620	180	210	132	
CAS-863-2T-20	873	995	728	585	355	M8	410	-	-	410	560	325	260	375	87,5	-	200	117,5	315	-	14	430	430	620	180	210	132	
CAS-971-2T-25	1012	1170	759	598	400	M10	450	-	-	460	670	420	294	425	100	-	224	132	355	-	14	550	550	500	150	150	145	
CAS-971-2T-30	1012	1170	881	720	400	M10	450	-	-	460	670	420	294	425	100	-	224	132	355	-	14	550	550	500	150	150	145	

CAS/EW-790...980

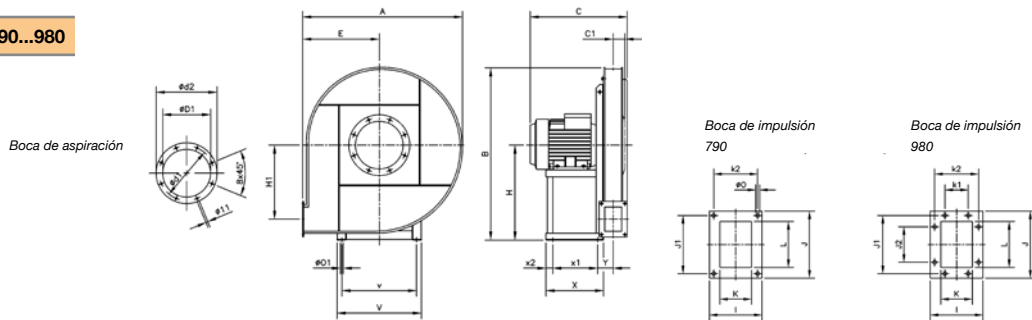

Modelo	A	B	C	C1	ø D1	ø D2	d1	x	ø	B	E	H	H1	I	J	J1	J2	K	K1	L	M	øO1	V	v	X	X1	X2	Y
CAS-790-2T-20	1100	1180	650	58	185	255	219	-	-	530	630	520	140	172	140	-	80	-	112	-	14	440	440	425	340	30	103	
CAS-980-2T-30	1120	1250	725	90	255	325	292	-	-	530	710	530	210	270	241	112	140	112	200	-	14	440	440	425	340	35	145	

CAS/EW-1250...1456

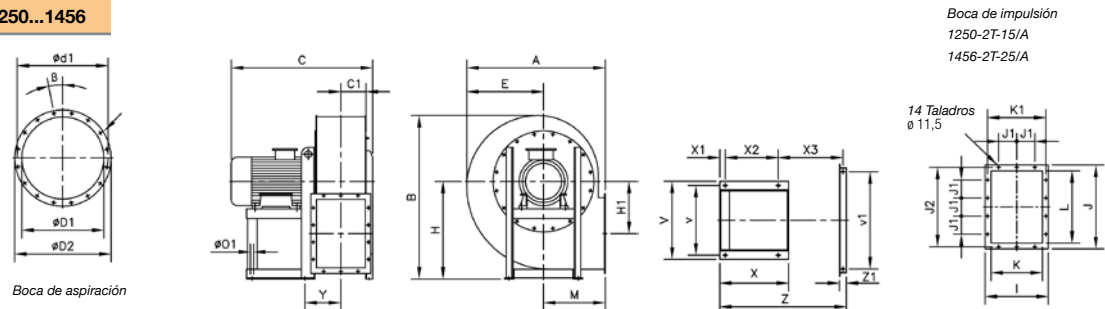

Modelo	A	B	C	C1	ø D1	ø D2	d1	x	ø	B	E	H	H1	I	J	J1	J2	K	K1	L	M	øO1	V	v	X	X1	X2	Y
CAS-1250-2T-15/A	865	1055	885	160	361	441	405	8x11,5	22°30'	510	630	365	360	480	125	448	280	332	400	355	14	440	440	425	30	340	202	
CAS-1456-2T-25/A	970	1185	900	163	456	535	497	12x12	15°	555	710	410	395	530	125	497	315	366	450	400	14	440	440	425	30	340	219	



Erp. Curvas características y datos ErP

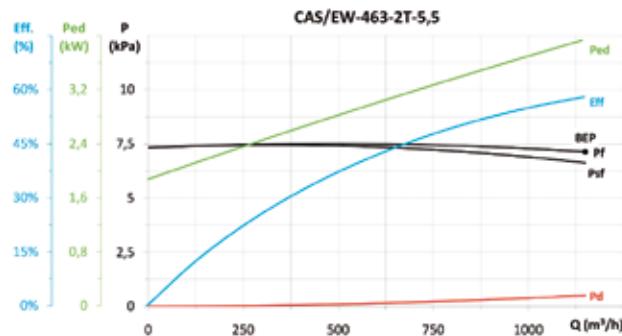

MC	EC	SR	Cc	η_e (%)*	N	[kW]	[m³/h]	[Pa]	[rpm]	VSD
B	T	1,07	1,05	60,7%	65,0	3,931	1150	7135	2916	NECESSARY

* η_e (%) = Eff. (%) x Cc

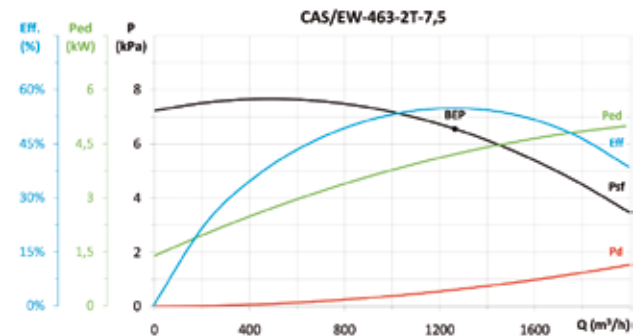

MC	EC	SR	Cc	η_e (%)*	N	[kW]	[m³/h]	[Pa]	[rpm]	VSD
A	S	1,07	1,04	57,3%	61,3	4,195	1264	6557,2	2954	NECESSARY

* η_e (%) = Eff. (%) x Cc

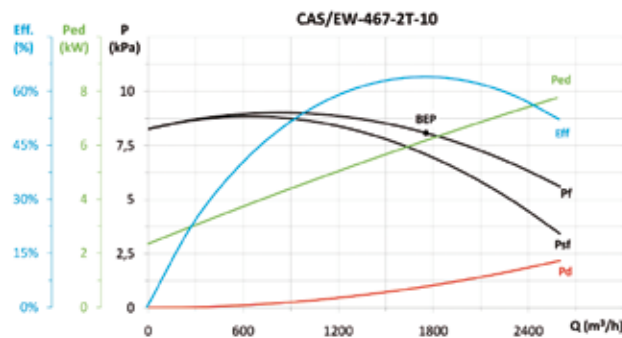

MC	EC	SR	Cc	η_e (%)*	N	[kW]	[m³/h]	[Pa]	[rpm]	VSD
B	T	1,08	1,04	66,5%	68,7	6,152	1754	8078,7	2954	NECESSARY

* η_e (%) = Eff. (%) x Cc

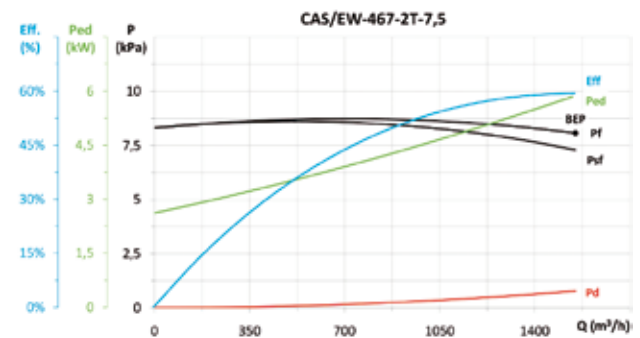

MC	EC	SR	Cc	η_e (%)*	N	[kW]	[m³/h]	[Pa]	[rpm]	VSD
B	T	1,08	1,04	61,8%	64,3	5,845	1550	8070,3	2936	NECESSARY

* η_e (%) = Eff. (%) x Cc

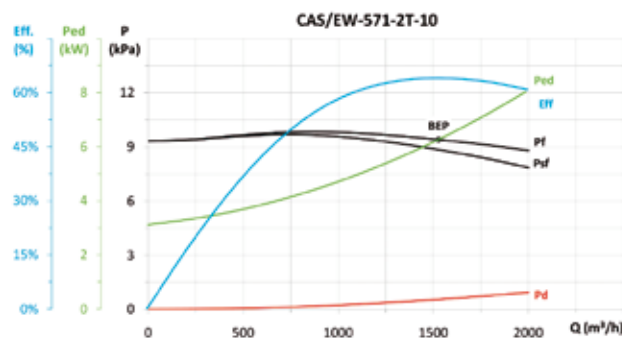

MC	EC	SR	Cc	η_e (%)*	N	[kW]	[m³/h]	[Pa]	[rpm]	VSD
B	T	1,09	1,04	66,6%	68,7	6,231	1528	9400,4	2953	NECESSARY

* η_e (%) = Eff. (%) x Cc

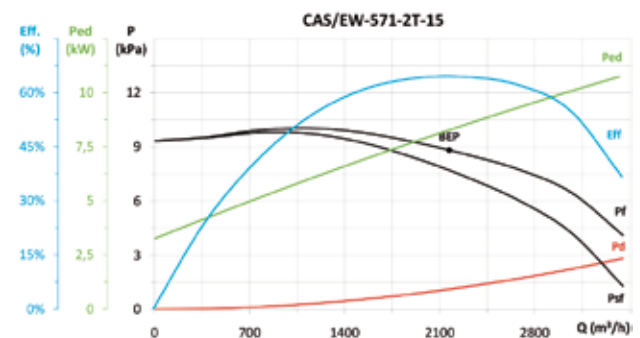

MC	EC	SR	Cc	η_e (%)*	N	[kW]	[m³/h]	[Pa]	[rpm]	VSD
B	T	1,09	1,04	67,1%	68,0	8,238	2170	8822,4	2951	NECESSARY

* η_e (%) = Eff. (%) x Cc

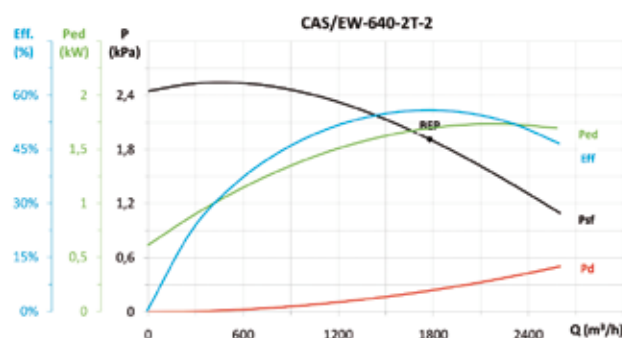

MC	EC	SR	Cc	η_e (%)*	N	[kW]	[m³/h]	[Pa]	[rpm]	VSD
A	S	1,02	1,07	59,8%	67,9	1,693	1778	1912,7	2886	NECESSARY

* η_e (%) = Eff. (%) x Cc

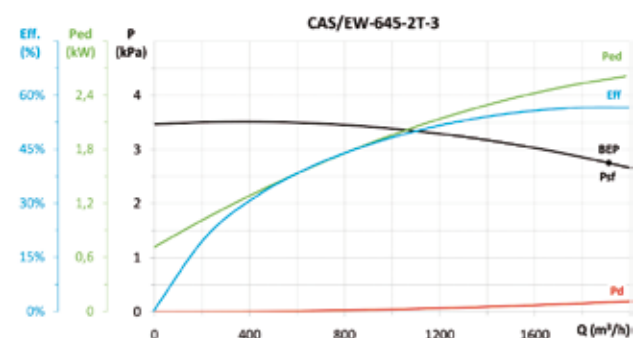

MC	EC	SR	Cc	η_e (%)*	N	[kW]	[m³/h]	[Pa]	[rpm]	VSD
A	S	1,03	1,06	60,1%	66,3	2,576	1912	2750,8	2913	NECESSARY

* η_e (%) = Eff. (%) x Cc



EFFICIENT WORK



Erp. Curvas características y datos Erp

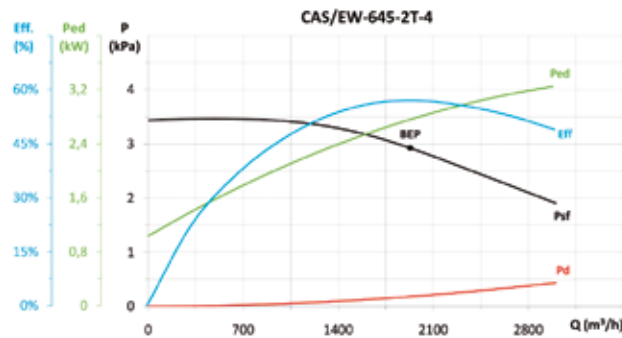

MC	EC	SR	Cc	η_e (%)*	N	[kW]	[m³/h]	[Pa]	[rpm]	VSD
A	S	1,03	1,06	60,3%	66,2	2,750	1930	2925,2	2932	NECESSARY

* η_e (%) = Eff. (%) x Cc

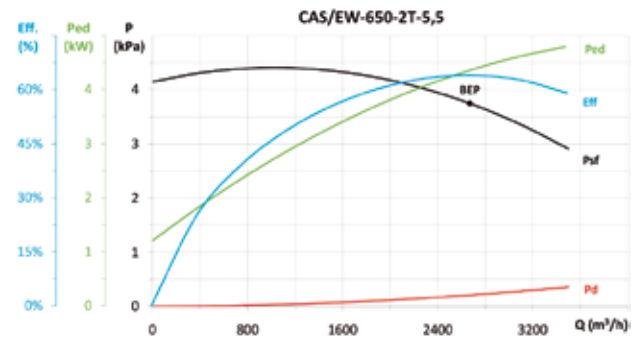

MC	EC	SR	Cc	η_e (%)*	N	[kW]	[m³/h]	[Pa]	[rpm]	VSD
A	S	1,04	1,04	66,8%	70,6	4,344	2671	3747,6	2908	NECESSARY

* η_e (%) = Eff. (%) x Cc

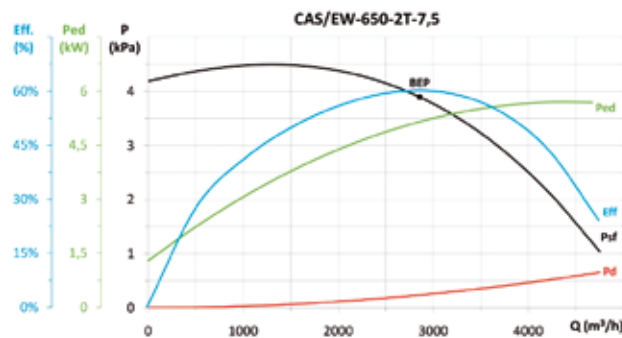

MC	EC	SR	Cc	η_e (%)*	N	[kW]	[m³/h]	[Pa]	[rpm]	VSD
A	S	1,04	1,04	62,6%	65,6	5,136	2858	3893,6	2944	NECESSARY

* η_e (%) = Eff. (%) x Cc

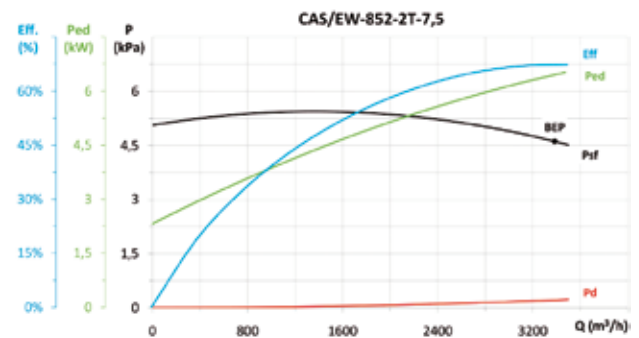

MC	EC	SR	Cc	η_e (%)*	N	[kW]	[m³/h]	[Pa]	[rpm]	VSD
A	S	1,05	1,04	70,1%	72,1	6,438	3385	4613,0	2930	NECESSARY

* η_e (%) = Eff. (%) x Cc

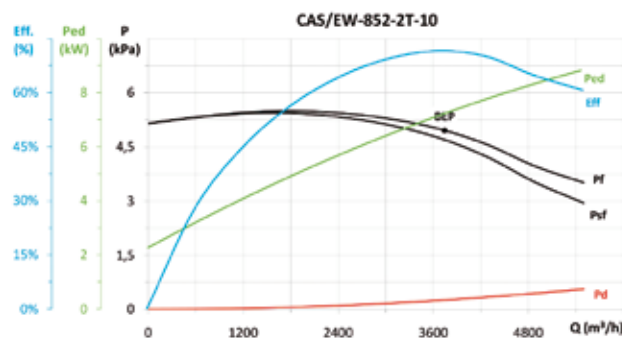

MC	EC	SR	Cc	η_e (%)*	N	[kW]	[m³/h]	[Pa]	[rpm]	VSD
B	T	1,05	1,04	74,5%	76,0	7,202	3744	4959,4	2946	NECESSARY

* η_e (%) = Eff. (%) x Cc

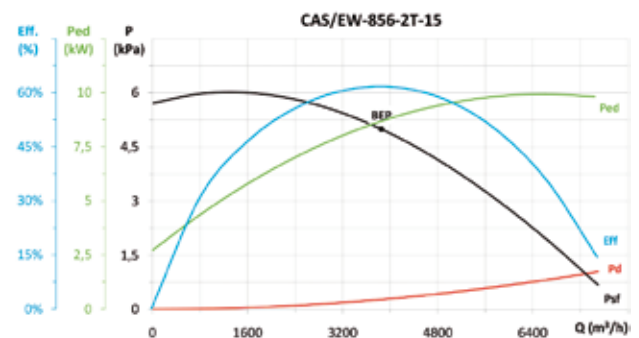

MC	EC	SR	Cc	η_e (%)*	N	[kW]	[m³/h]	[Pa]	[rpm]	VSD
A	S	1,05	1,04	64,2%	64,8	8,657	3851	4993,7	2949	NECESSARY

* η_e (%) = Eff. (%) x Cc

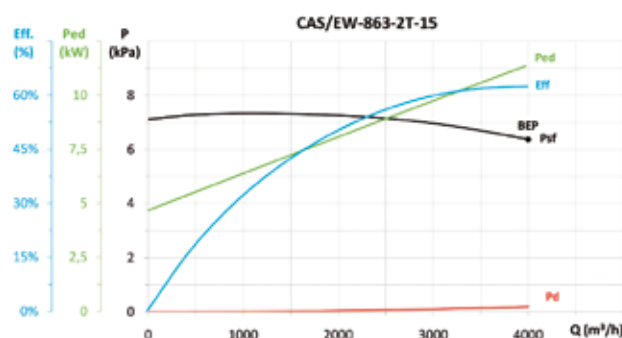

MC	EC	SR	Cc	η_e (%)*	N	[kW]	[m³/h]	[Pa]	[rpm]	VSD
A	S	1,06	1,04	64,9%	64,8	11,344	3998	6372,7	2933	NECESSARY

* η_e (%) = Eff. (%) x Cc

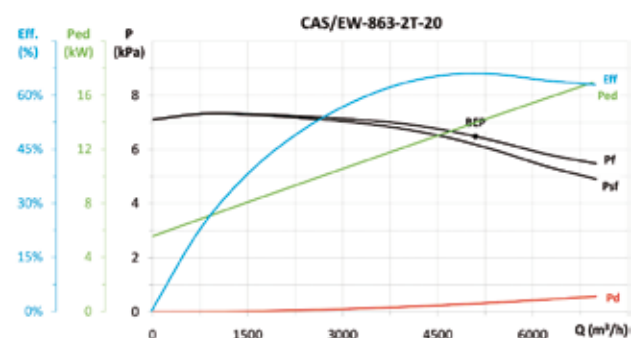

MC	EC	SR	Cc	η_e (%)*	N	[kW]	[m³/h]	[Pa]	[rpm]	VSD
B	T	1,06	1,04	68,7%	68,4	13,911	5097	6485,8	2955	NECESSARY

* η_e (%) = Eff. (%) x Cc



Erp. Curvas características y datos ErP

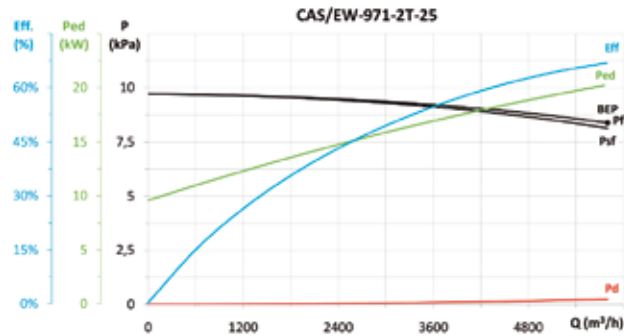

MC	EC	SR	Cc	η_e (%)*	N	[kW]	[m ³ /h]	[Pa]	[rpm]	VSD
B	T	1,08	1,04	69,5%	68,8	20,204	5800	8386,5	2946	NECESSARY

* η_e (%) = Eff. (%) x Cc

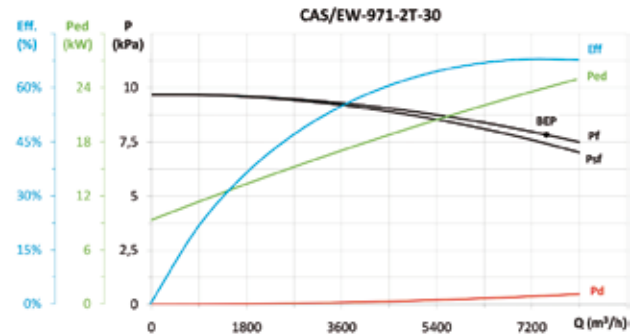

MC	EC	SR	Cc	η_e (%)*	N	[kW]	[m ³ /h]	[Pa]	[rpm]	VSD
B	T	1,08	1,04	70,7%	69,8	23,927	7478	7832,6	2956	NECESSARY

* η_e (%) = Eff. (%) x Cc

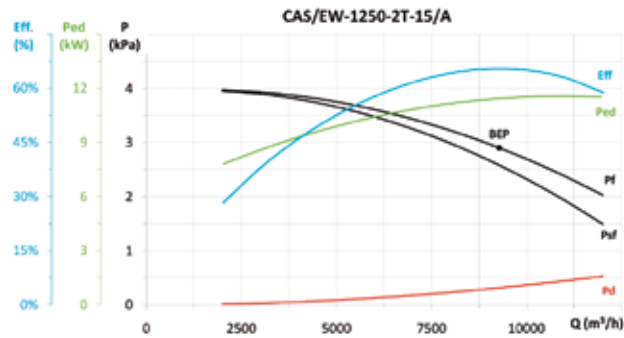

MC	EC	SR	Cc	η_e (%)*	N	[kW]	[m ³ /h]	[Pa]	[rpm]	VSD
B	T	1,03	1,04	68,1%	68,0	11,435	9279	2904,1	2932	NECESSARY

* η_e (%) = Eff. (%) x Cc

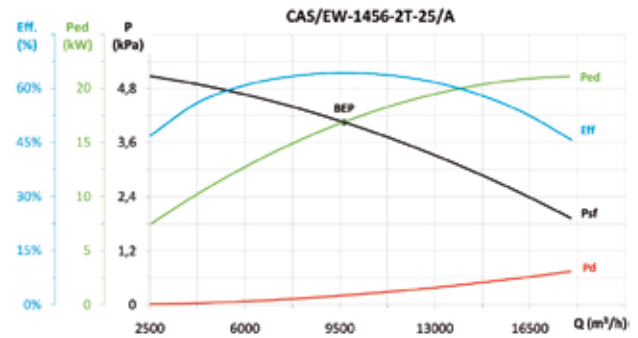

MC	EC	SR	Cc	η_e (%)*	N	[kW]	[m ³ /h]	[Pa]	[rpm]	VSD
A	S	1,04	1,04	66,8%	66,3	16,913	9659	4051,3	2955	NECESSARY

* η_e (%) = Eff. (%) x Cc

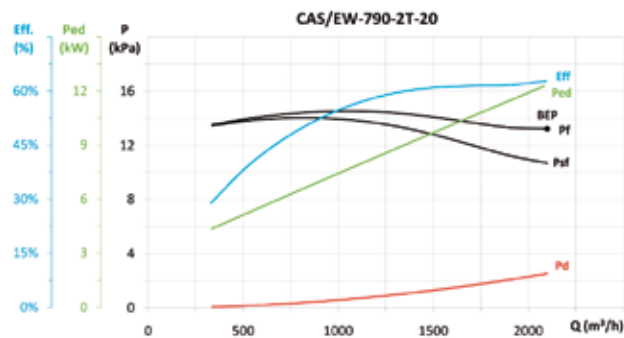

MC	EC	SR	Cc	η_e (%)*	N	[kW]	[m ³ /h]	[Pa]	[rpm]	VSD
B	T	1,13	1,04	65,3%	65,1	12,280	2100	13220	2959	NECESSARY

* η_e (%) = Eff. (%) x Cc

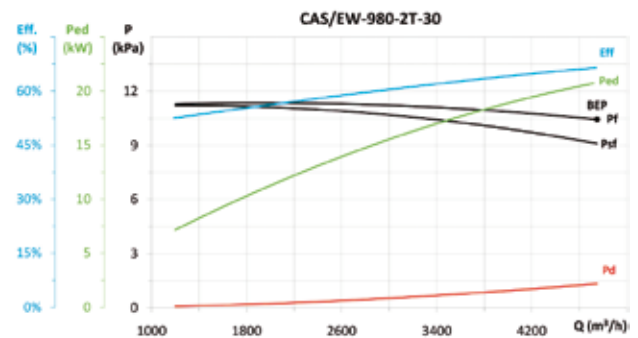

MC	EC	SR	Cc	η_e (%)*	N	[kW]	[m ³ /h]	[Pa]	[rpm]	VSD
B	T	1,10	1,04	69,1%	68,4	20,726	4750	10439	2962	NECESSARY

* η_e (%) = Eff. (%) x Cc

Accesorios

Ver apartado accesorios.





EFFICIENT WORK



F-400



MOTORES TRIFÁSICOS DE ALTA Eficiencia IE3

TCR/R/EW CJTCR/R/EW



VARIADOR VELOCIDAD
VSD: Variador electrónico de velocidad.
· VSD1/A-RFM
· VSD3/A-RFT
Suministro según pedido

CONTROL
Suministro como accesorio opcional

ALIMENTACIÓN
VSD1/A-RFM:
220-240 V 50/60 Hz
VSD3/A-RFT:
380-415 V 50/60 Hz

Extractores centrífugos y unidades de extracción 400°C/2h, con turbina a reacción equipados con motor asíncrono de alta eficiencia IE3 regulable electrónicamente.

TCR/R/EW: Extractores centrífugos 400°C/2h, para trabajar en el exterior de la zona de riesgo de incendios, de simple aspiración y gran robustez, equipados con turbina con álabes hacia atrás, equipados con motor asíncrono de alta eficiencia IE3 regulable electrónicamente.
CJTCR/R/EW: Unidades de extracción 400°C/2h con caja aislada acústicamente, para trabajar en el exterior de la zona de riesgo de incendios, de simple aspiración y gran robustez, equipados con motor asíncrono de alta eficiencia IE3 regulable electrónicamente.

Ventilador:

- Envoltente en chapa de acero
- Turbina con álabes a reacción, en chapa de acero de gran robustez, con pintura anticorrosiva
- Homologación según norma EN-12101-3-2002.

Motor y variador electrónico:

- Motores eficiencia IE3, regulables electrónicamente.
- Se suministrará el variador de velocidad VSD según pedido.
- Variador electrónico de velocidad (VSD) regulable mediante señal externa de 0-10 V.
- Se recomienda instalar filtros senoidales entre ventilador y variador electrónico de velocidad (VSD), cuando haya gran distancia entre ellos.
- Variador electrónico de velocidad (VSD), disponibles con entrada monofásica 220-240 V 50/60 Hz hasta 3cv (Tipo VSD1/A-RFM) o con entrada trifásica 380-415 V 50/60 Hz (Tipo VSD3/A-RFT).
- Por defecto se entrega el variador electrónico de velocidad (VSD) programado a velocidad constante.

Temperatura de trabajo (VSD):

- -25 °C +50 °C.
- Motores clase F, con rodamientos a bolas, protección IP55.
- Trifásicos 230/400 V 50 Hz (hasta 5,5 CV) y 400/690 V 50 Hz (potencias superiores a 5,5 CV).
- Temperatura máxima del aire a transportar: Servicio S1 -20 °C+ 250 °C en continuo, Servicio S2 200 °C/2h, 300 °C/2h y 400 °C/2h

Acabado:

- Anticorrosivo en resina de poliéster polimerizada a 190 °C, previo desengrase con tratamiento nanotecnológico libre de fosfatos.
- CJTCR/R/EW: Anticorrosivo en chapa de acero galvanizado



Código de pedido ventilador

TCR/R/EW — 1240 — 2T — IE3

TCR/R/EW: Extractores centrífugos 400°C/2h, con turbina a reacción de alta eficiencia, "efficient work"
CJTCR/R/EW: Unidades de extracción 400°C/2h, con turbina a reacción de alta eficiencia, "efficient work"

Tamaño turbina

Número de polos:
2T=2850 r/min
4T=1400 r/min
6T=900 r/min

Motores trifásicos IE3

Código de pedido con subministro de variador electrónico (VSD) incluido

TCR/R/EW — 1240 — 2T — IE3 — VSD1 — D

TCR/R/EW: Extractores centrífugos 400°C/2h, con turbina a reacción de alta eficiencia, "efficient work"
CJTCR/R/EW: Unidades de extracción 400°C/2h, con turbina a reacción de alta eficiencia, "efficient work"

Tamaño turbina

Número de polos:
2T=2850 r/min
4T=1400 r/min
6T=900 r/min

Motores trifásicos IE3

VSD1: Equipados con VSD1/A-RFM, variador electrónico de velocidad, alimentación monofásica 220-240 V 50/60 Hz.
VSD3: Equipados con VSD3/A-RFT, variador electrónico de velocidad, alimentación trifásica 380-415 V 50/60 Hz.

D: Versión estándar, suministro del VSD programado a velocidad constante.
P: Suministro con VSD programado para control de presión y transmisor de presión Si-Presión
K: Suministro con VSD programado e integrado en una caja BOXPRES KIT para el control de presión. Disponible sólo para ventiladores con potencia motor inferior o igual a 2,2 kW.

Características técnicas

Modelo	Velocidad min/max (r/min)	VSD monofásico 230 V 50/60 Hz		VSD trifásico 400 V 50/60 Hz		Intensidad máxima Motor 50 Hz		Potencia instalada (kW)	Caudal máximo min/max (m³/h)	Nivel presión sonora Lp dB(A)		Peso aprox. (Kg)	
		Intensidad máxima entrada (A)	Modelo VSD	Intensidad máxima entrada (A)	Modelo VSD	230V	400V (A)			TCR/R/EW min/max	CJTCR/R/EW min/max	TCR/R/EW min/max	CJTCR/R/EW min/max
TCR/R/EW CJTCR/R/EW	1240-2T 1160/2900	-	-	9,44	VSD3/A-RFT-5.5	13	7,5	-	4,00	4440 / 11100	66 / 86	61 / 81	93 147
TCR/R/EW CJTCR/R/EW	1240-4T 570/1420	8,32	VSD1/A-RFM-1	2,31	VSD3/A-RFT-1	2,82	1,62	-	0,75	2330 / 5800	51 / 71	46 / 66	71 125
TCR/R/EW CJTCR/R/EW	1445-2T 1175/2935	-	-	17,45	VSD3/A-RFT-10	-	13,9	8,06	7,50	6605 / 16500	67 / 87	62 / 82	126 210
TCR/R/EW CJTCR/R/EW	1445-4T 580/1455	11,87	VSD1/A-RFM-2	3,30	VSD3/A-RFT-2	4,07	2,34	-	1,10	3200 / 8030	52 / 72	47 / 67	93 177
TCR/R/EW CJTCR/R/EW	1650-4T 575/1440	15,78	VSD1/A-RFM-2	4,38	VSD3/A-RFT-2	5,41	3,11	-	1,50	4195 / 10500	54 / 74	48 / 68	114 189
TCR/R/EW CJTCR/R/EW	1650-6T 375/940	8,69	VSD1/A-RFM-1	2,41	VSD3/A-RFT-1	3,36	1,93	-	0,75	2955 / 7410	44 / 64	39 / 59	111 186
TCR/R/EW CJTCR/R/EW	1856-4T 575/1440	-	-	7,20	VSD3/A-RFT-5.5	10,7	6,15	-	3,00	6050 / 15150	59 / 79	54 / 74	152 273
TCR/R/EW CJTCR/R/EW	1856-6T 380/945	12,43	VSD1/A-RFM-2	3,45	VSD3/A-RFT-2	4,68	2,69	-	1,10	4040 / 10050	50 / 70	45 / 65	145 266
TCR/R/EW CJTCR/R/EW	2063-4T 585/1465	-	-	12,81	VSD3/A-RFT-7.5	-	10,3	5,97	5,50	9765 / 24450	60 / 80	55 / 75	225 380
TCR/R/EW CJTCR/R/EW	2063-6T 380/950	16,64	VSD1/A-RFM-2	4,62	VSD3/A-RFT-2	6,43	3,7	-	1,50	6440 / 16100	51 / 71	46 / 66	209 364
TCR/R/EW CJTCR/R/EW	2271-4T 590/1470	-	-	25,10	VSD3/A-RFT-15	-	21,4	12,4	11,00	13890 / 34610	65 / 85	59 / 79	315 508
TCR/R/EW CJTCR/R/EW	2271-6T 390/970	-	-	7,39	VSD3/A-RFT-5.5	12	6,91	-	3,00	9145 / 22750	56 / 76	51 / 71	280 473

Dimensiones mm

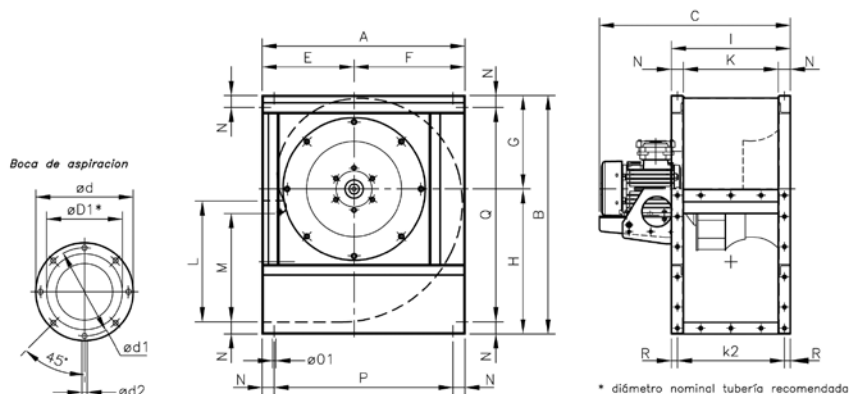

Modelo	A	B	C	ØD1*	Ød	Ød1	Ød2	E	F	G	H	I	M	N	Ø01	P	Q	R
TCR/R/EW 1240-2T	673	790	734	400	472	444	M.8	305	368	310	480	395	358.5	40	11	593	710	20
TCR/R/EW 1240-4T	673	790	634	400	472	444	M.8	305	368	310	480	395	358.5	40	11	593	710	20
TCR/R/EW 1445-2T	765	880	815	450	522	494	M.8	350	415	339	541	445	407	45	11	675	790	20
TCR/R/EW 1445-4T	765	880	727	450	522	494	M.8	350	415	339	541	445	407	45	11	675	790	20
TCR/R/EW 1650-4T	832	970	770.5	500	582	555	M.10	375	457	378	592	490	445	45	13	742	880	20
TCR/R/EW 1650-6T	832	970	770.5	500	582	555	M.10	375	457	378	592	490	445	45	13	742	880	20
TCR/R/EW 1856-4T	925	1084	857.5	560	645	615	M.10	415	510	424	660	550	493	50	13	825	984	25
TCR/R/EW 1856-6T	925	1084	828	560	645	615	M.10	415	510	424	660	550	493	50	13	825	984	25
TCR/R/EW 2063-4T	1037	1218	955	630	720	688	M.10	465	572	477	741	620	530	60	13	917	1098	30
TCR/R/EW 2063-6T	1037	1218	932	630	720	688	M.10	465	572	477	741	620	530	60	13	917	1098	30
TCR/R/EW 2271-4T	1173	1375	1149	710	800	768	M.12	525	648	538	837	690	603.5	65	13	1043	1245	32.5
TCR/R/EW 2271-6T	1173	1375	1112	710	800	768	M.12	525	648	538	837	690	603.5	65	13	1043	1245	32.5



EFFICIENT WORK



Dimensiones mm

Boca impulsión

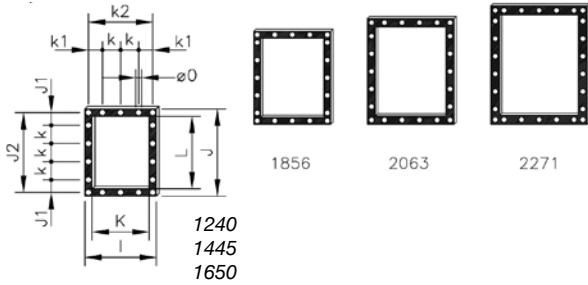

Modelo	I	J	J1	J2	K	k	k1	k2	L	Ø0
TCR/R/EW-1240	395	480	70	440	315	100	77.5	355	400	11
TCR/R/EW-1445	445	540	99	498	355	100	102.5	405	450	11
TCR/R/EW-1650	490	590	87.5	550	400	125	100	450	500	13
TCR/R/EW-1856	550	660	55	610	450	125	125	500	560	13
TCR/R/EW-2063	620	750	95	690	500	125	92.5	560	630	13
TCR/R/EW-2271	690	840	75	775	560	125	62.5	625	710	13

Suministro standard: LG-270

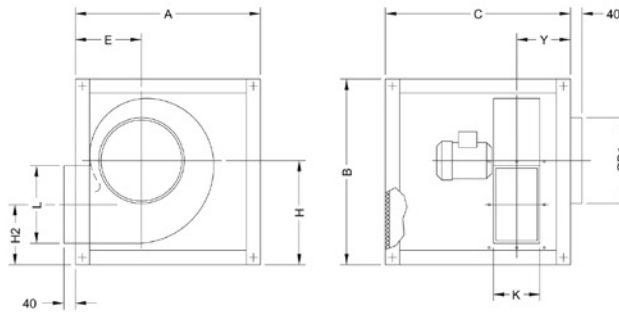

Modelo	A	B	C	ØD1	E	H	H2	K	L	Y
CJTTCR/R/EW-1240	970	970	970	400	312	549	308	315	400	307.5
CJTTCR/R/EW-1445	1070	1070	1070	450	357	610	339	355	450	333.5
CJTTCR/R/EW-1650	1160	1160	1160	500	382	660	365	400	500	355
CJTTCR/R/EW-1856	1260	1260	1050	560	422	727	399	450	560	360
CJTTCR/R/EW-2063	1400	1400	1200	630	472	810	444	500	630	395
CJTTCR/R/EW-2271	1555	1555	1355	710	532	906	560	560	715	430

Suministro bajo demanda: LG-0

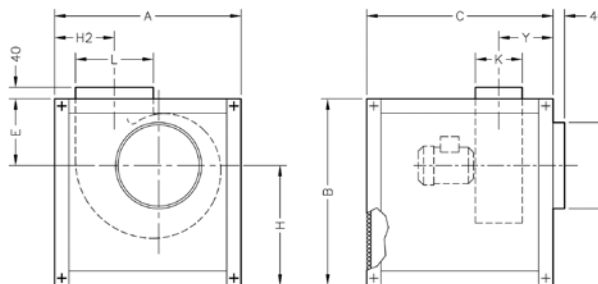

Modelo	A	B	C	ØD1	E	H	H2	K	L	Y
CJTTCR/R/EW-1240	970	970	970	400	533	437	322	315	400	307.5
CJTTCR/R/EW-1445	1070	1070	1070	450	586	484	367	355	450	333.5
CJTTCR/R/EW-1650	1160	1160	1160	500	634.5	525.5	391.5	400	500	355
CJTTCR/R/EW-1856	1260	1260	1050	560	681.5	578.5	442.5	450	560	360
CJTTCR/R/EW-2063	1400	1400	1200	630	759	641	482	500	630	395
CJTTCR/R/EW-2271	1555	1555	1355	710	838	717	518.5	560	715	430

Dimensiones mm

Suministro bajo demanda: LG-90

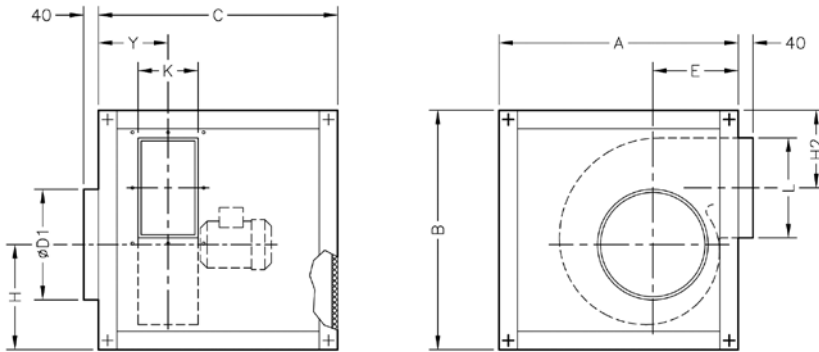

Detalle taladros boca impulsión

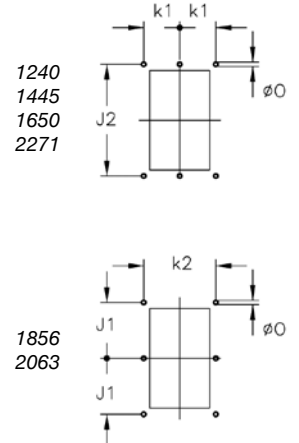

Modelo	A	B	C	ØD1	E	H	H2	K	L	Y
CJTCR/R/EW-1240	970	970	970	400	312	379	350	315	400	307.5
CJTCR/R/EW-1445	1070	1070	1070	450	357	408	391	355	450	333.5
CJTCR/R/EW-1650	1160	1160	1160	500	382	447	419	400	500	355
CJTCR/R/EW-1856	1260	1260	1050	560	422	495	438	450	560	360
CJTCR/R/EW-2063	1400	1400	1200	630	472	546	488	500	630	395
CJTCR/R/EW-2271	1555	1555	1355	710	532	607	532	560	715	430

Modelo	k1	k2	J1	J2	Ø0
CJTCR/R/EW-1240	177.5	-	-	440	11
CJTCR/R/EW-1445	202.5	-	-	498	11
CJTCR/R/EW-1650	225	-	-	550	13
CJTCR/R/EW-1856	-	500	305	-	13
CJTCR/R/EW-2063	-	560	345	-	13
CJTCR/R/EW-2271	312.5	-	-	775	13



Erp. Curvas características y datos ErP

Consultar curvas CMR/EW

Orientaciones

Suministro standard LG 270



Accesorios

Ver apartado accesorios.

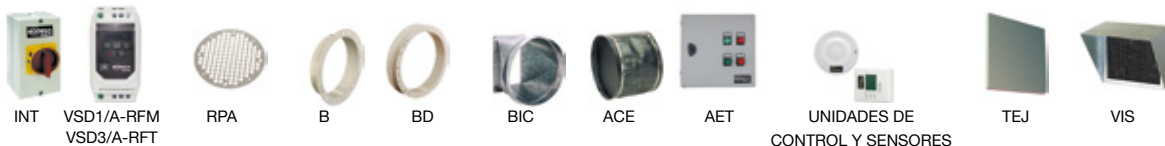



EFFICIENT WORK



MOTOR BRUSHLESS INDUSTRIAL E.C.

CJLINE/EW

Unidades de extracción 400°C/2h, con entrada y salida lineal, equipados con motor Brushless industrial E.C.



VARIADOR VELOCIDAD
VSD: Variador electrónico de velocidad.
VSD1/B
VSD3/B

Suministro incluido con el ventilador

CONTROL
Suministro como accesorio opcional

ALIMENTACIÓN
VSD1/B:
220-240 V 50/60 Hz
VSD3/B:
380-415 V 50/60 Hz

Unidades de extracción en línea 400°C/2h, para trabajar en el exterior de la zona de riesgo de incendio equipados con motor Brushless industrial E.C.

Ventilador:

- Estructura en chapa de acero galvanizado
- Turbina con álabes a reacción, en chapa de acero
- Homologación según norma EN-12101-3-2002
- Dirección aire sentido lineal

Motor y variador electrónico:

- Motores brushless industriales E.C. de muy alta eficiencia, equipados con variador electrónico de velocidad (VSD), regulable mediante señal externa de control 0-10 V.
- Se recomienda instalar el variador electrónico de velocidad (VSD) fuera de la zona de trabajo.
- La señal externa puede suministrarse a través de un control manual o automático con salida 0-10 V.
- Variador electrónico de velocidad (VSD), disponibles con entrada monofásica

220-240 V 50/60 Hz (Tipo VSD1/B) o trifásica 380-415 V 50/60 Hz (Tipo VSD3/B).

- Por defecto se entrega el variador electrónico de velocidad (VSD) programado a velocidad constante.
- Temperatura de trabajo ventilador: -25 °C +60 °C.
- Temperatura de trabajo (VSD): -25 °C +50 °C.

Acabado:

- Anticorrosivo en chapa de acero galvanizado



Código de pedido con suministro de variador electrónico (VSD) incluido

CJLINE/EW — 1131 — 4 — B — T — D

CJLINE/EW: Unidades de extracción 400 °C/2h, de alta eficiencia "Efficient work", con entrada y salida lineal

Tamaño turbina

Número de polos:
4=1410 r/min
6=960 r/min

Motores Brushless industriales E.C.

M: Equipados con VSD1/B, variador electrónico de velocidad, alimentación monofásica 220-240 V 50/60 Hz.

T: Equipados con VSD3/B, variador electrónico de velocidad, alimentación trifásica 380-415 V 50/60 Hz.

D: Versión estándar, suministro del VSD programado a velocidad constante.

P: Suministro con VSD programado para control de presión y transmisor de presión Si-Presión

K: Suministro con VSD programado e integrado en una caja BOXPRES KIT/B para el control de presión.

Características técnicas

Modelo	Velocidad min/max (r/min)	VSD monofásico 230 V 50/60 Hz		VSD trifásico 400 V 50/60 Hz		Potencia eléctrica máxima (W)	Caudal máximo min/max (m³/h)	Nivel presión sonora min/max dB(A)	Peso aprox. (Kg)
		Intensidad máxima entrada (A)	Modelo VSD	Intensidad máxima entrada (A)	Modelo VSD				
CJLINE/EW-1131-4	300 / 1410	1,44	VSD1/B-0.37	0,42	VSD3/B-0.75	175	410 / 1920	17 / 51	39
CJLINE/EW-1235-4	300 / 1410	2,79	VSD1/B-0.37	0,82	VSD3/B-0.75	340	625 / 2945	22 / 56	54
CJLINE/EW-1235-6	300 / 960	1,17	VSD1/B-0.37	0,34	VSD3/B-0.75	140	595 / 1900	25 / 50	55
CJLINE/EW-1640-4	300 / 1410	5,82	VSD1/B-0.75	1,37	VSD3/B-1.5	660	1000 / 4700	27 / 61	65
CJLINE/EW-1640-6	300 / 960	2,13	VSD1/B-0.37	0,62	VSD3/B-0.75	255	920 / 2950	29 / 54	66
CJLINE/EW/H-1650-4	300 / 1410	15,89	VSD1/B-1.5	3,74	VSD3/B-1.5	1825	2085 / 9800	40 / 74	99
CJLINE/EW-1845-4	300 / 1410	7,94	VSD1/B-0.75	1,87	VSD3/B-1.5	905	1415 / 6650	31 / 65	83
CJLINE/EW-1845-6	300 / 960	4,28	VSD1/B-0.75	1,00	VSD3/B-1.5	480	1340 / 4280	32 / 57	81
CJLINE/EW-1856-6	300 / 960	8,32	VSD1/B-1.5	1,96	VSD3/B-1.5	955	2420 / 7750	34 / 59	142
CJLINE/EW-2063-6	300 / 960	11,51	VSD1/B-1.5	2,71	VSD3/B-1.5	1325	3470 / 11100	36 / 61	185

Características acústicas

Los valores indicados, se determinan mediante medidas de nivel de presión y potencia sonora en dB(A) obtenidas en campo libre a una distancia equivalente a dos veces la envergadura del ventilador más el diámetro de la turbina, con un mínimo de 1,5 mts.

Espectro de potencia sonora Lw(A) en dB(A) por banda de frecuencia en Hz

Modelo	63	125	250	500	1000	2000	4000	8000	Modelo	63	125	250	500	1000	2000	4000	8000
CJLINE/EW-1131-4	42	51	57	56	60	60	52	46	CJLINE/EW/H-1650-4	64	74	82	84	83	85	76	66
CJLINE/EW-1235-4	49	58	64	63	67	66	59	53	CJLINE/EW-1845-4	60	66	71	72	75	77	69	63
CJLINE/EW-1235-6	43	52	58	57	61	60	53	47	CJLINE/EW-1845-6	52	58	63	64	67	69	61	55
CJLINE/EW-1640-4	56	62	67	68	71	73	65	59	CJLINE/EW-1856-6	58	64	69	70	73	72	65	60
CJLINE/EW-1640-6	49	55	60	61	64	66	58	52	CJLINE/EW-2063-6	60	66	72	72	76	76	68	61

Dimensiones mm

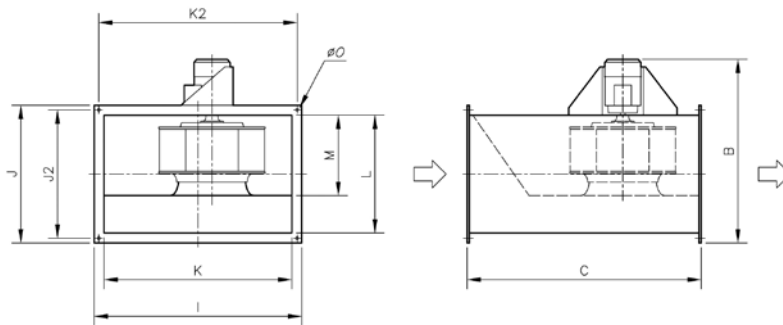

Modelo	B	C	I	J	J2	K	k2	L	M	ØO
CJLINE/EW-1131	760	710	620	510	483	560	593	450	175	10
CJLINE/EW-1235	830	800	680	560	533	620	653	500	213	10
CJLINE/EW-1640	890	900	770	620	593	710	743	560	262	10
CJLINE/EW-1650/H	942	1000	860	690	663	800	833	630	290	10
CJLINE/EW-1845	1010	1000	860	690	663	800	833	630	290	10
CJLINE/EW-1856	1280	1250	1060	860	833	1000	1033	800	378	10
CJLINE/EW-2063	1390	1400	1205	980	938	1125	1163	900	378	12



Erp. Curvas características y datos ErP

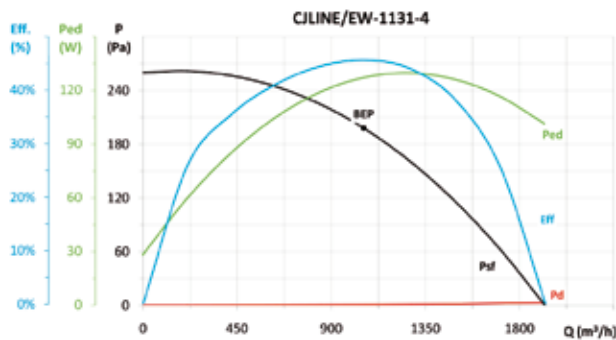

MC	EC	SR	Cc	η_e (%)*	N	[kW]	[m³/h]	[Pa]	[rpm]	VSD
C	S	1,00	1,15	52,5%	72,4	0,127	1055	198	1410	INCLUDED

* η_e (%) = Eff. (%) x Cc

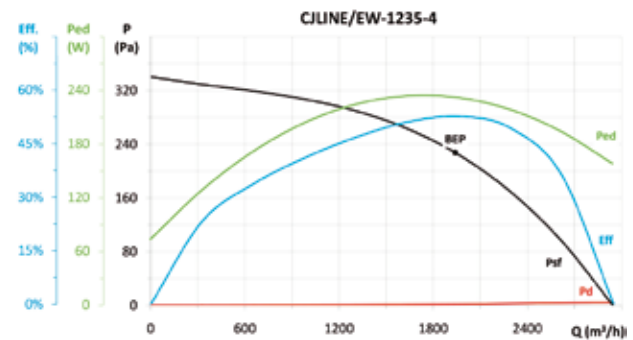

MC	EC	SR	Cc	η_e (%)*	N	[kW]	[m³/h]	[Pa]	[rpm]	VSD
C	S	1,00	1,13	59,6%	76,8	0,232	1940	227	1410	INCLUDED

* η_e (%) = Eff. (%) x Cc

Accesorios

Ver apartado accesorios.





EFFICIENT WORK



Erp. Curvas características y datos ErP

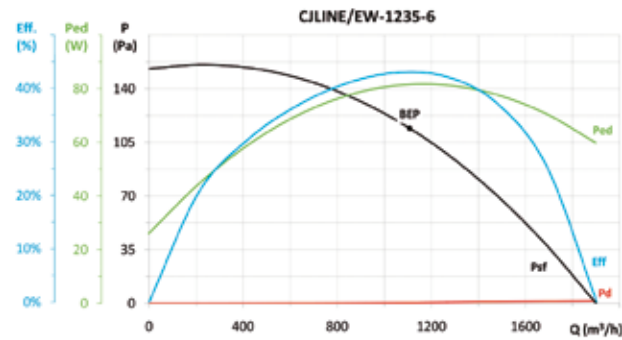

MC	EC	SR	Cc	η_e (%)*	N	[kW]	[m³/h]	[Pa]	[rpm]	VSD
C	S	-	-	-	-	0,082	1108	114	960	INCLUDED

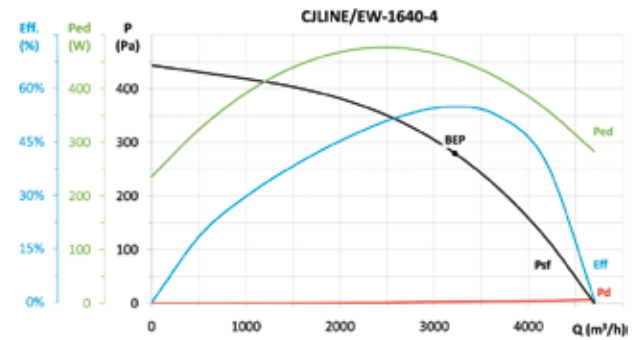

MC	EC	SR	Cc	η_e (%)*	N	[kW]	[m³/h]	[Pa]	[rpm]	VSD
C	S	1,00	1,11	61,1%	75,1	0,455	3221	280	1410	INCLUDED

* η_e (%) = Eff. (%) x Cc

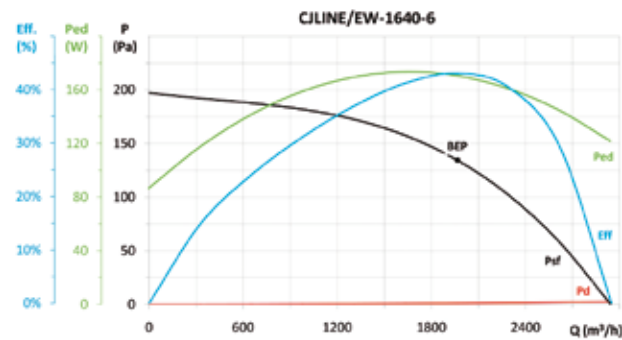

MC	EC	SR	Cc	η_e (%)*	N	[kW]	[m³/h]	[Pa]	[rpm]	VSD
C	S	1,00	1,14	49,1%	67,7	0,170	1965	134	960	INCLUDED

* η_e (%) = Eff. (%) x Cc

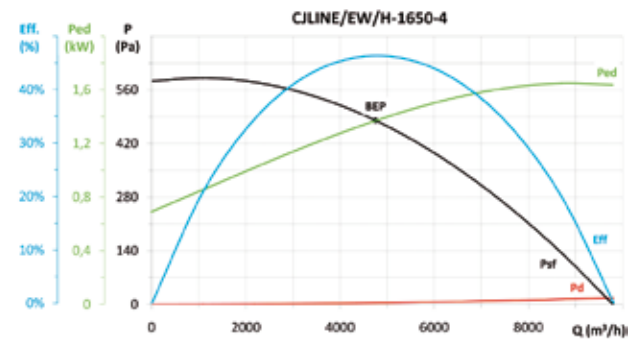

MC	EC	SR	Cc	η_e (%)*	N	[kW]	[m³/h]	[Pa]	[rpm]	VSD
C	S	1,00	1,08	50,0%	59,0	1,368	4752	480	1410	INCLUDED

* η_e (%) = Eff. (%) x Cc

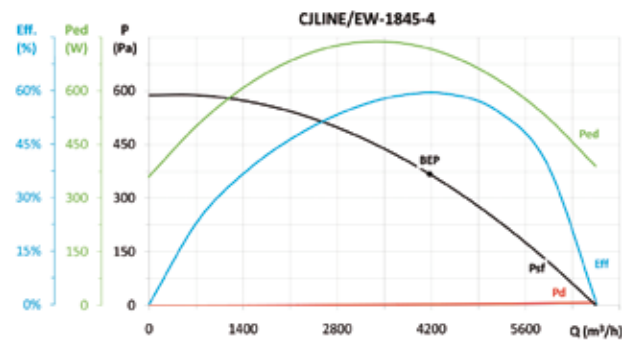

MC	EC	SR	Cc	η_e (%)*	N	[kW]	[m³/h]	[Pa]	[rpm]	VSD
C	S	1,00	1,10	65,2%	77,2	0,718	4174	368	1410	INCLUDED

* η_e (%) = Eff. (%) x Cc

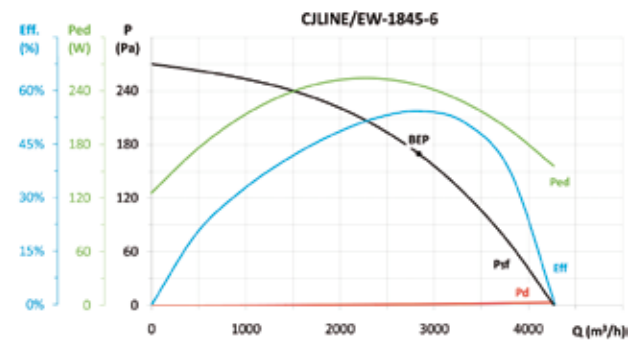

MC	EC	SR	Cc	η_e (%)*	N	[kW]	[m³/h]	[Pa]	[rpm]	VSD
C	S	1,00	1,13	61,3%	78,1	0,247	2836	170	960	INCLUDED

* η_e (%) = Eff. (%) x Cc

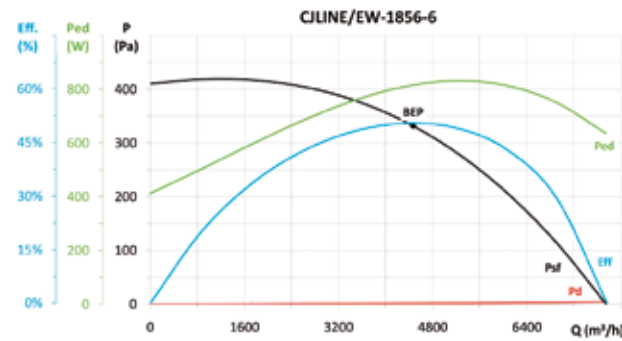

MC	EC	SR	Cc	η_e (%)*	N	[kW]	[m³/h]	[Pa]	[rpm]	VSD
C	S	1,00	1,09	55,2%	66,7	0,816	4468	332	960	INCLUDED

* η_e (%) = Eff. (%) x Cc

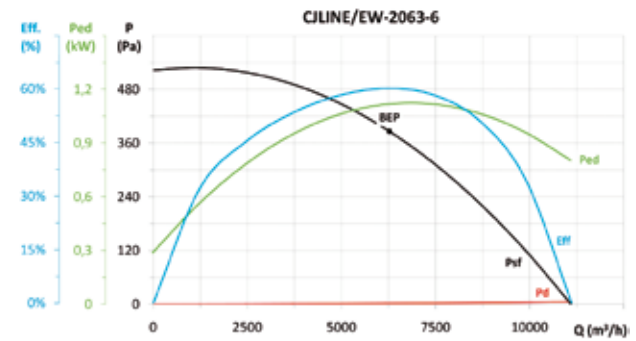

MC	EC	SR	Cc	η_e (%)*	N	[kW]	[m³/h]	[Pa]	[rpm]	VSD
C	S	1,00	1,08	65,3%	75,3	1,118	6275	386	960	INCLUDED

* η_e (%) = Eff. (%) x Cc

CJEC/EW



VARIADOR VELOCIDAD
VSD: Variador electrónico de velocidad.
VSD1/B
VSD3/B

Suministro incluido con el ventilador

CONTROL
Suministro como accesorio opcional

ALIMENTACIÓN
VSD1/B:
220-240 V 50/60 Hz
VSD3/B:
380-415 V 50/60 Hz

Unidades de extracción con puerta de gran dimensión para poder realizar el mantenimiento con gran facilidad, equipados con motor Brushless industrial E.C.

Ventilador:

- Estructura en chapa de acero galvanizado
- Turbina con álabes a reacción, en chapa de acero galvanizado
- Homologación según norma EN-12101-3-2002
- Posibilidad de montar la boca de impulsión en cualquier lateral de la caja, durante la instalación

Motor y variador electrónico:

- Motores brushless industriales E.C. de muy alta eficiencia, equipados con variador electrónico de velocidad (VSD), regulable mediante señal externa de control 0-10 V.
- Se recomienda instalar el variador electrónico de velocidad (VSD) fuera de la zona de trabajo.
- La señal externa puede suministrarse a través de un control manual o automático con salida 0-10 V.
- Variador electrónico de velocidad (VSD), disponibles con entrada monofásica

220-240 V 50/60 Hz (Tipo VSD1/B) o trifásica 380-415 V 50/60 Hz (Tipo VSD3/B).

- Por defecto se entrega el variador electrónico de velocidad (VSD) programado a velocidad constante.
- Temperatura de trabajo ventilador: -25 °C +60 °C.
- Temperatura de trabajo (VSD): -25 °C +50 °C.

Acabado:

- Anticorrosivo en chapa de acero galvanizado



MOTOR BRUSHLESS INDUSTRIAL E.C.

Código de pedido con suministro de variador electrónico (VSD) incluido

CJEC/EW — 280 — 4 — B — T — D

CJEC/EW: Unidades de extracción 400 °C/2h, de alta eficiencia "Efficient work", con salida de aire horizontal

Tamaño turbina

Número de polos:
4=1410 r/min
6=960 r/min

Motores Brushless industriales E.C.

M: Equipados con VSD1/B, variador electrónico de velocidad, alimentación monofásica 220-240 V 50/60 Hz.
T: Equipados con VSD3/B, variador electrónico de velocidad, alimentación trifásica 380-415 V 50/60 Hz.

D: Versión estándar, suministro del VSD programado a velocidad constante.
P: Suministro con VSD programado para control de presión y transmisor de presión Si-Presión
K: Suministro con VSD programado e integrado en una caja BOXPRES KIT/B para el control de presión.

Características técnicas

Modelo	Velocidad min/max (r/min)	VSD monofásico 230 V 50/60 Hz		VSD trifásico 400 V 50/60 Hz		Potencia eléctrica máxima (W)	Caudal máximo min/max (m³/h)	Nivel presión sonora Lp dB(A)		Peso aprox. (Kg)
		Intensidad máxima entrada (A)	Modelo VSD	Intensidad máxima entrada (A)	Modelo VSD			Aspiración min/max	Descarga min/max	
CJEC/EW-280-4	300 / 1410	1,14	VSD1/B-0.37	0,34	VSD3/B-0.75	140	290 / 1370	21 / 55	26 / 60	61
CJEC/EW-315-4	300 / 1410	1,44	VSD1/B-0.37	0,42	VSD3/B-0.75	175	350 / 1650	25 / 59	29 / 63	63
CJEC/EW-355-4	300 / 1410	2,79	VSD1/B-0.37	0,82	VSD3/B-0.75	340	640 / 3000	27 / 61	32 / 66	75
CJEC/EW-400-4	300 / 1410	5,82	VSD1/B-0.75	1,37	VSD3/B-1.5	660	905 / 4250	31 / 65	35 / 69	79
CJEC/EW-450-4	300 / 1410	7,94	VSD1/B-0.75	1,87	VSD3/B-1.5	905	1170 / 5500	34 / 68	38 / 72	89
CJEC/EW-500-4	300 / 1410	15,89	VSD1/B-1.5	3,74	VSD3/B-1.5	1825	1895 / 8900	36 / 70	41 / 75	110
CJEC/EW-560-6	300 / 960	11,51	VSD1/B-1.5	2,71	VSD3/B-1.5	1325	2970 / 9500	52 / 77	57 / 82	129

Características acústicas

Los valores indicados, se determinan mediante medidas de nivel de presión y potencia sonora en dB(A) obtenidas en campo libre a una distancia equivalente a dos veces la envergadura del ventilador más el diámetro de la turbina, con un mínimo de 1,5 mts.

Espectro de potencia sonora Lw(A) en dB(A) por banda de frecuencia en Hz

Modelo	Valores tomados a la aspiración con caudal máximo.								Valores tomados a la descarga con caudal máximo.							
	63	125	250	500	1000	2000	4000	8000	63	125	250	500	1000	2000	4000	8000
280-4	42	47	62	59	60	58	53	45	42	45	65	66	65	65	58	49
315-4	53	62	64	64	64	62	54	42	45	59	67	69	68	68	60	53
355-4	52	62	68	63	64	66	62	53	48	67	68	71	72	71	64	55
400-4	60	69	72	65	68	69	65	56	52	70	73	73	75	74	70	59
450-4	56	65	71	76	72	71	65	57	56	69	75	77	79	76	71	61
500-4	57	62	73	76	76	75	69	60	58	67	78	79	83	80	74	63
560-6	69	78	80	81	82	82	79	57	65	79	85	86	90	86	81	72



EFFICIENT WORK



Dimensiones mm

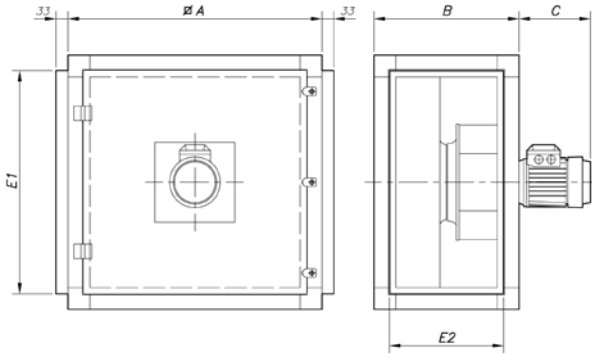

Modelo	ØA	B	C	E1	E2
CJEC/EW-280	700	400	200	618	318
CJEC/EW-315	700	400	200	618	318
CJEC/EW-355	800	505	200	718	423
CJEC/EW-400	800	505	225	718	423
CJEC/EW-450	900	550	225	818	468
CJEC/EW-500	900	550	260	818	468
CJEC/EW-560	1000	700	290	918	618



Erp. Curvas características y datos ErP

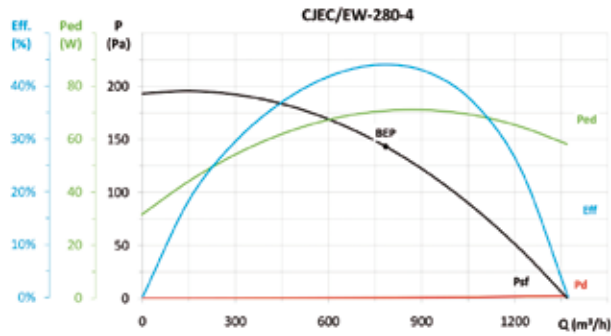

MC	EC	SR	Cc	η_e (%)*	N	[kW]	[m³/h]	[Pa]	[rpm]	VSD
C	S	-	-	-	-	0,071	784	143	1410	INCLUDED

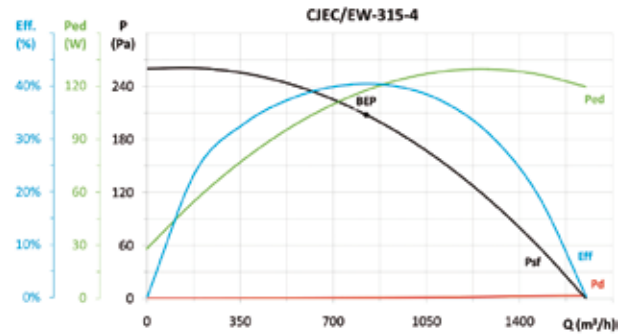

MC	EC	SR	Cc	η_e (%)*	N	[kW]	[m³/h]	[Pa]	[rpm]	VSD
C	S	-	-	-	-	0,118	824	208	1410	INCLUDED

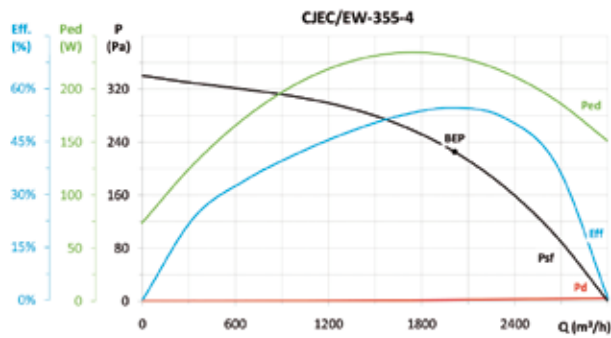

MC	EC	SR	Cc	η_e (%)*	N	[kW]	[m³/h]	[Pa]	[rpm]	VSD
C	S	1,00	1,13	61,8%	79,0	0,231	2012	225	1410	INCLUDED

* η_e (%) = Eff. (%) x Cc

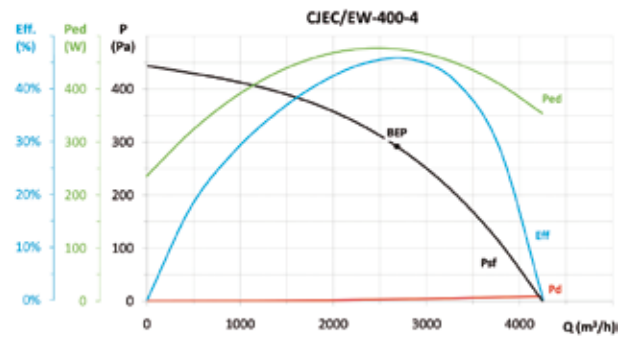

MC	EC	SR	Cc	η_e (%)*	N	[kW]	[m³/h]	[Pa]	[rpm]	VSD
C	S	1,00	1,11	50,8%	64,7	0,475	2685	292	1410	INCLUDED

* η_e (%) = Eff. (%) x Cc

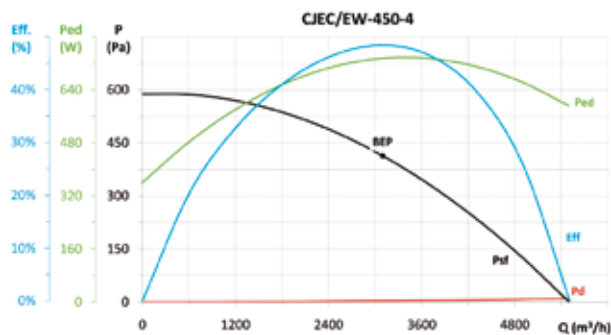

MC	EC	SR	Cc	η_e (%)*	N	[kW]	[m³/h]	[Pa]	[rpm]	VSD
C	S	1,00	1,10	53,1%	65,0	0,735	3097	414	1410	INCLUDED

* η_e (%) = Eff. (%) x Cc

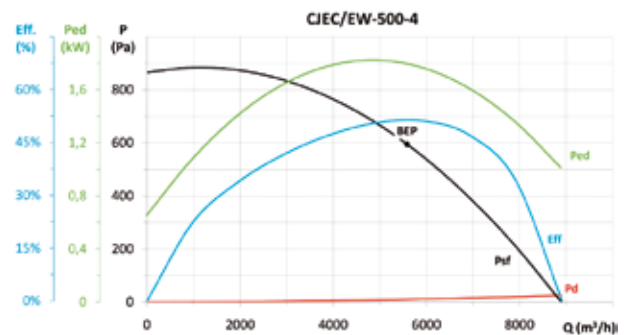

MC	EC	SR	Cc	η_e (%)*	N	[kW]	[m³/h]	[Pa]	[rpm]	VSD
C	S	1,01	1,07	55,0%	62,8	1,798	5587	595	1410	INCLUDED

* η_e (%) = Eff. (%) x Cc



Erp. Curvas características y datos ErP

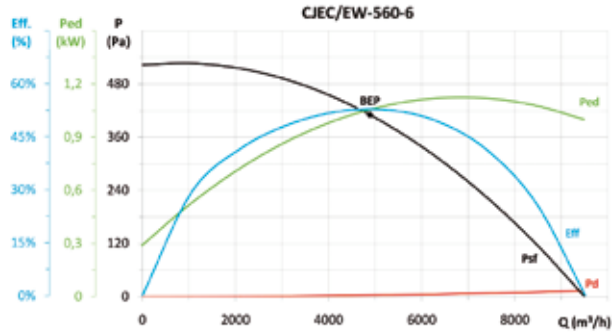

MC	EC	SR	Cc	η_{pe} (%)*	N	[kW]	[m³/h]	[Pa]	[rpm]	VSD
C	S	1,00	1,09	57,4%	67,6	1,055	4889	410	960	INCLUDED

* η_{pe} (%) = Eff. (%) x Cc

Instalaciones CJEC

Posibilidad de instalación de la serie CJEC cambiando la colocación de los paneles de aspiración e impulsión.

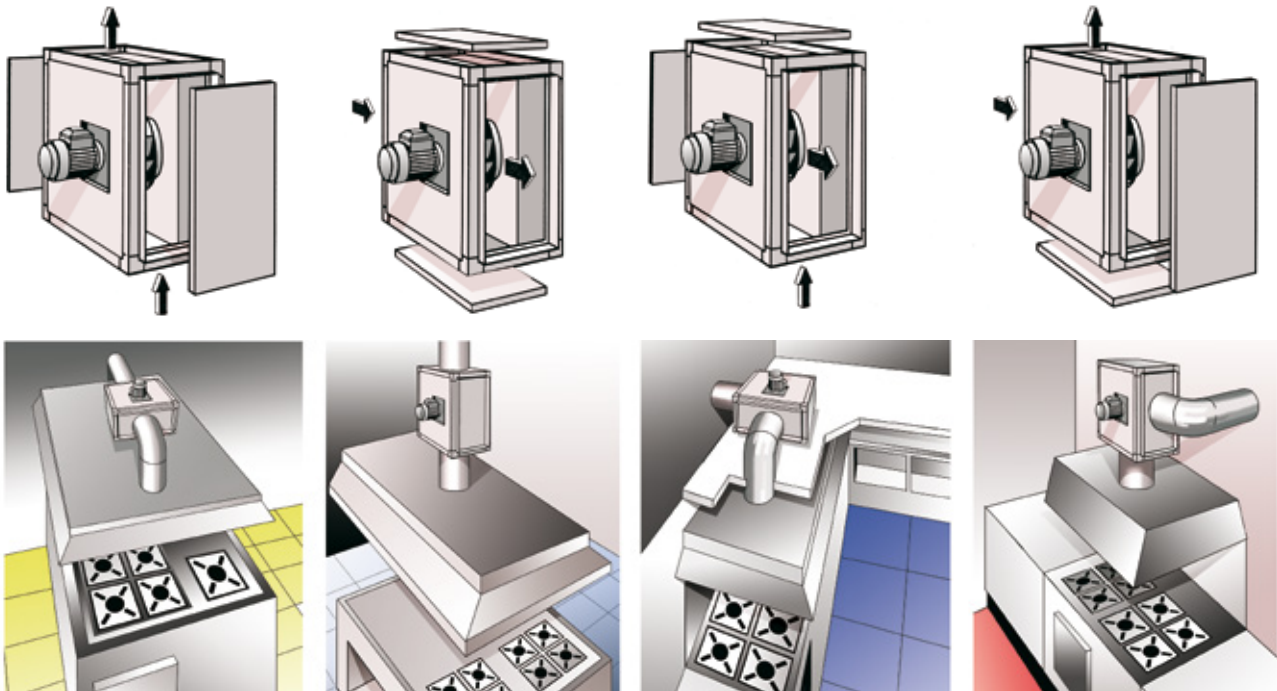

Accesorios

Ver apartado accesorios.





EFFICIENT WORK



CHT/EW CVT/EW



CHT

CVT



VARIADOR VELOCIDAD
VSD: Variador electrónico de velocidad.
- VSD1/B
- VSD3/B

Suministro incluido con el ventilador

CONTROL
Suministro como accesorio opcional

ALIMENTACIÓN
VSD1/B:
220-240 V 50/60 Hz
VSD3/B:
380-415 V 50/60 Hz

Extractores centrífugos de tejado 400 °C/2h, con salida de aire horizontal o vertical, equipados con motor Brushless industrial E.C.

CHT/EW: Extractores centrífugos de tejado 400 °C/2h, con salida de aire horizontal, sombrero en aluminio, equipados con motor Brushless industrial E.C.

CVT/EW: Extractores centrífugos de tejado 400 °C/2h, con salida de aire vertical, sombrero en aluminio, equipados con motor Brushless industrial E.C.

Ventilador:

- Base soporte en chapa de acero galvanizado
- Turbina con álabes a reacción, en chapa de acero galvanizado.
- Rejilla protección anti pájaros.
- Sombrero deflector anti lluvia en aluminio

Motor y variador electrónico:

- Motores brushless industriales E.C. de muy alta eficiencia, equipados con variador electrónico de velocidad (VSD), regulable mediante señal externa de control 0-10 V.
- Se recomienda instalar el variador electrónico de velocidad (VSD) fuera de la zona de trabajo.
- La señal externa puede suministrarse a través de un control manual o automático con salida 0-10 V.
- Variador electrónico de velocidad (VSD), disponibles con entrada monofásica

220-240 V 50/60 Hz (Tipo VSD1/B) o trifásica 380-415 V 50/60 Hz (Tipo VSD3/B).

- Por defecto se entrega el variador electrónico de velocidad (VSD) programado a velocidad constante.
- Temperatura de trabajo ventilador: -25 °C +60 °C.
- Temperatura de trabajo (VSD): -25 °C +50 °C.

Acabado:

- Anticorrosivo en chapa de acero galvanizado



MOTOR
BRUSHLESS
INDUSTRIAL E.C.



Código de pedido con suministro de variador electrónico (VSD) incluido

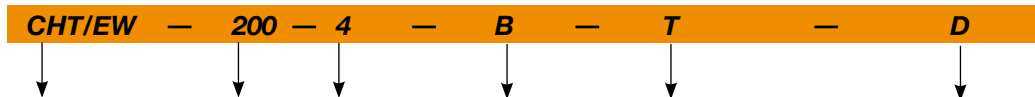

CHT/EW: Extractores centrífugos de tejado 400 °C/2h, de alta eficiencia "Efficient work", con salida de aire horizontal

Tamaño turbina

Número de polos:
4=1410 r/min
6=960 r/min

Motores Brushless industriales E.C.

M: Equipados con VSD1/B, variador electrónico de velocidad, alimentación monofásica 220-240 V 50/60 Hz.

T: Equipados con VSD3/B, variador electrónico de velocidad, alimentación trifásica 380-415 V 50/60 Hz.

D: Versión estándar, suministro del VSD programado a velocidad constante.

P: Suministro con VSD programado para control de presión y transmisor de presión Si-Presión
K: Suministro con VSD programado e integrado en una caja BOXPRES
KIT/B para el control de presión.

CVT/EW: Extractores centrífugos de tejado 400 °C/2h, de alta eficiencia "Efficient work", con salida de aire vertical

Características técnicas

Modelo	Velocidad min/max (r/min)	VSD monofásico 230 V 50/60 Hz		VSD trifásico 400 V 50/60 Hz		Potencia eléctrica máxima (W)	Caudal máximo min/max (m³/h)	Nivel presión sonora Lp dB(A)		Peso aprox. (Kg)
		Intensidad máxima entrada (A)	Modelo VSD	Intensidad máxima entrada (A)	Modelo VSD			Aspiración min/max	Descarga min/max	
CHT/EW CVT/EW 200-4	300 / 1410	1,14	VSD1/B-0.37	0,34	VSD3/B-0.75	140	310 / 1450	3 / 37	9 / 43	25
CHT/EW CVT/EW 225-4	300 / 1410	1,44	VSD1/B-0.37	0,42	VSD3/B-0.75	175	445 / 2100	7 / 41	13 / 47	25
CHT/EW CVT/EW 225-6	300 / 960	0,93	VSD1/B-0.37	0,27	VSD3/B-0.75	110	440 / 1400	5 / 30	11 / 36	26
CHT/EW CVT/EW 250-4	300 / 1410	2,79	VSD1/B-0.37	0,82	VSD3/B-0.75	340	660 / 3100	11 / 45	16 / 50	34
CHT/EW CVT/EW 250-6	300 / 960	1,17	VSD1/B-0.37	0,34	VSD3/B-0.75	140	625 / 2000	8 / 33	15 / 40	35
CHT/EW CVT/EW 315-4	300 / 1410	5,82	VSD1/B-0.75	1,37	VSD3/B-1.5	660	1055 / 4950	14 / 48	20 / 54	39
CHT/EW CVT/EW 315-6	300 / 960	2,13	VSD1/B-0.37	0,62	VSD3/B-0.75	255	1000 / 3200	12 / 37	18 / 43	39
CHT/EW CVT/EW 400-4	300 / 1410	7,94	VSD1/B-0.75	1,87	VSD3/B-1.5	905	1490 / 7000	21 / 55	27 / 61	57
CHT/EW CVT/EW 400-6	300 / 960	4,28	VSD1/B-0.75	1,00	VSD3/B-1.5	480	1405 / 4500	19 / 44	25 / 50	56
CHT/EW CVT/EW 450-4	300 / 1410	15,89	VSD1/B-1.5	3,74	VSD3/B-1.5	1825	2170 / 10200	25 / 59	30 / 64	66
CHT/EW CVT/EW 450-6	300 / 960	5,64	VSD1/B-0.75	1,32	VSD3/B-1.5	635	2155 / 6900	22 / 47	29 / 54	59
CHT/EW CVT/EW 500-6	300 / 960	11,51	VSD1/B-1.5	2,71	VSD3/B-1.5	1325	3750 / 12000	26 / 51	32 / 57	103



Características acústicas

Los valores indicados, se determinan mediante medidas de nivel de presión y potencia sonora en dB(A) obtenidas en campo libre a una distancia de 6 mts.

Espectro de potencia sonora Lw(A) en dB(A) por banda de frecuencia en Hz

Aspiración. Modelo	Valores tomados a la aspiración con 2/3 caudal máximo (2/3Qmax).							Descarga. Valores tomados a la descarga con 2/3 caudal máximo (2/3Qmax).								
	63	125	250	500	1000	2000	4000	8000	63	125	250	500	1000	2000	4000	8000
200-4	35	41	52	55	56	52	50	44	39	44	58	60	61	61	56	51
225-4	42	51	56	56	60	59	52	46	41	50	60	64	67	64	57	51
225-6	31	40	45	45	49	48	41	35	30	39	49	53	56	53	46	40
250-4	46	55	60	60	64	63	56	50	44	53	63	67	70	67	60	54
250-6	34	43	48	48	52	51	44	38	34	43	53	57	60	57	50	44
315-4	50	56	62	62	65	68	59	53	49	61	69	71	72	72	64	56
315-6	39	45	51	51	54	57	48	42	38	50	58	60	61	61	53	45
400-4	62	69	74	74	78	77	70	65	60	72	80	82	83	80	73	65
400-6	46	52	58	58	61	64	55	49	45	57	65	67	68	68	60	52
450-4	62	69	74	74	78	77	70	65	60	72	80	82	83	80	73	65
450-6	50	57	62	62	66	65	58	53	50	62	70	72	73	70	63	55
500-6	54	60	65	66	70	69	62	55	50	64	72	76	75	72	66	60

Dimensiones mm

CHT/EW	Diagrama de dimensiones					
	A	øD*	øF	G	H	øI
200	552	250	570	450	360	12
225	570	250	570	450	360	12
250	632	355	726	560	450	12
315	682	355	726	560	450	12
400	755	500	856	710	590	12
450	770	500	856	710	590	12
500	846	630	1075	900	750	14

CVT/EW	Diagrama de dimensiones						
	A	A1	øD*	øF	G	H	øI
200	500	308	250	530	450	360	12
225	517	308	250	530	450	360	12
250	580	380	355	705	560	450	12
315	630	380	355	705	560	450	12
400	690	475	500	900	710	590	12
450	705	475	500	900	710	590	12
500	775	545	630	1100	900	750	14

Accesorios

Ver apartado accesorios

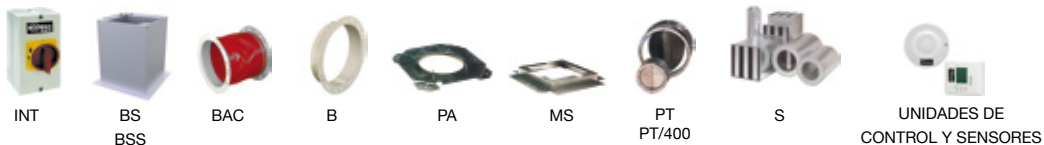



EFFICIENT WORK



Erp. Curvas características y datos ErP

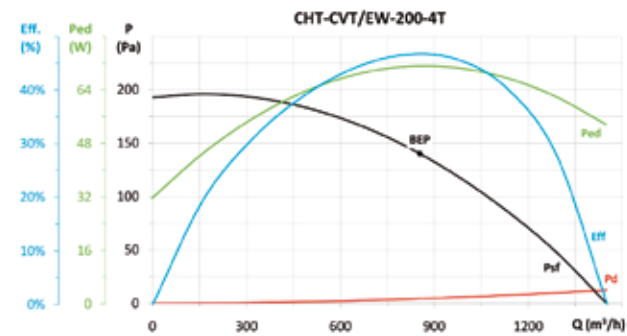

MC	EC	SR	Cc	η_e (%)*	N	[kW]	[m³/h]	[Pa]	[rpm]	VSD
C	S	-	-	-	-	0,071	853	140	1410	INCLUDED

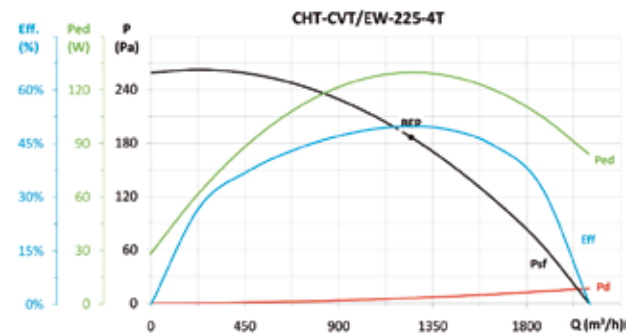

MC	EC	SR	Cc	η_e (%)*	N	[kW]	[m³/h]	[Pa]	[rpm]	VSD
C	S	1,00	1,15	57,3%	77,1	0,130	1247	187	1410	INCLUDED

* η_e (%) = Eff. (%) x Cc

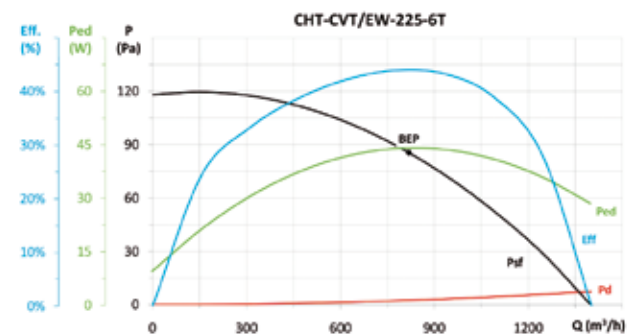

MC	EC	SR	Cc	η_e (%)*	N	[kW]	[m³/h]	[Pa]	[rpm]	VSD
C	S	-	-	-	-	0,044	818	86	960	INCLUDED

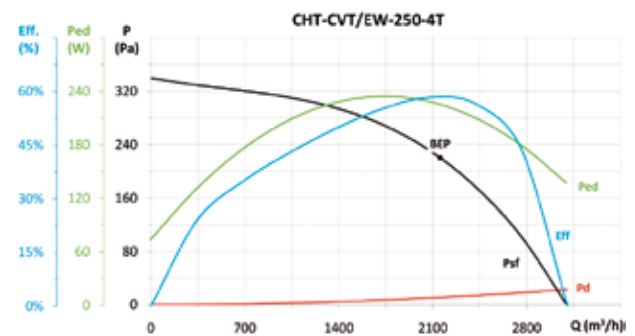

MC	EC	SR	Cc	η_e (%)*	N	[kW]	[m³/h]	[Pa]	[rpm]	VSD
C	S	1,00	1,13	66,3%	83,6	0,226	2156	220	1410	INCLUDED

* η_e (%) = Eff. (%) x Cc

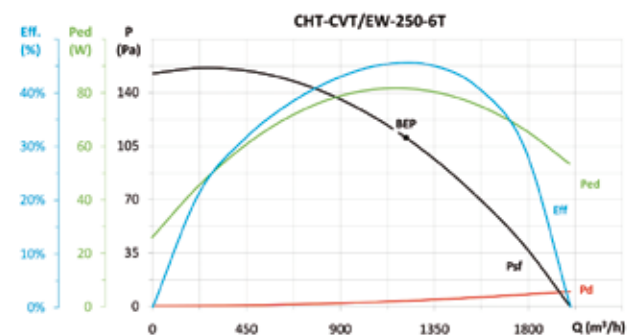

MC	EC	SR	Cc	η_e (%)*	N	[kW]	[m³/h]	[Pa]	[rpm]	VSD
C	S	-	-	-	-	0,082	1214	111	960	INCLUDED

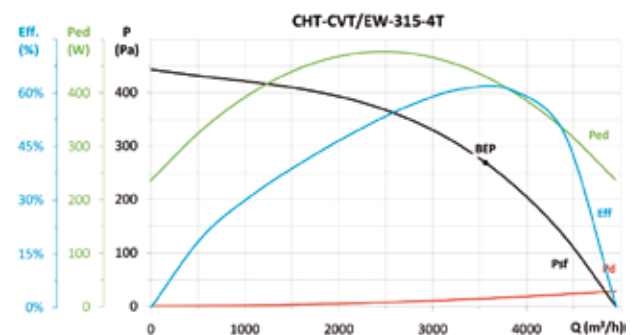

MC	EC	SR	Cc	η_e (%)*	N	[kW]	[m³/h]	[Pa]	[rpm]	VSD
C	S	1,00	1,11	68,8%	83,1	0,431	3562	269	1410	INCLUDED

* η_e (%) = Eff. (%) x Cc

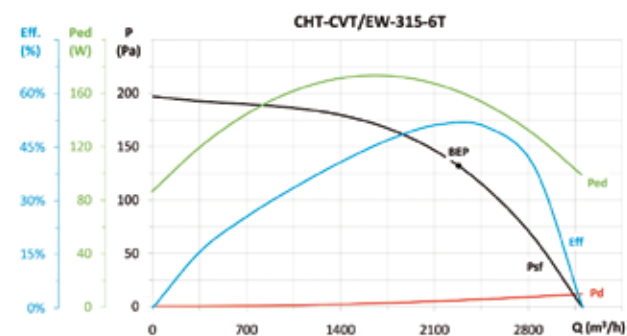

MC	EC	SR	Cc	η_e (%)*	N	[kW]	[m³/h]	[Pa]	[rpm]	VSD
C	S	1,00	1,14	59,2%	78,0	0,161	2281	132	960	INCLUDED

* η_e (%) = Eff. (%) x Cc

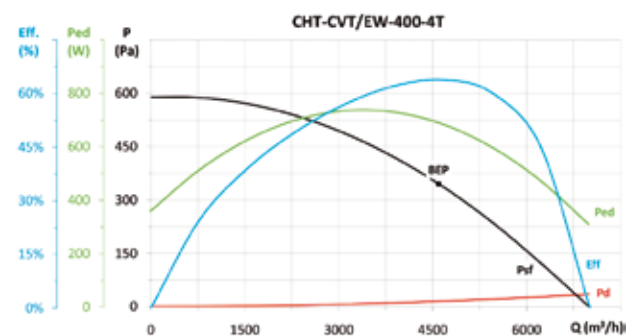

MC	EC	SR	Cc	η_e (%)*	N	[kW]	[m³/h]	[Pa]	[rpm]	VSD
C	S	1,00	1,10	70,2%	82,4	0,691	4594	345	1410	INCLUDED

* η_e (%) = Eff. (%) x Cc



Erp. Curvas características y datos ErP

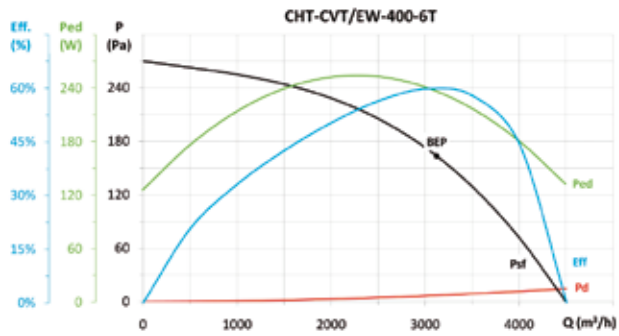

MC	EC	SR	Cc	η_e (%)*	N	[kW]	[m³/h]	[Pa]	[rpm]	VSD
C	S	1,00	1,13	67,9%	84,9	0,237	3124	164	960	INCLUDED

* η_e (%) = Eff. (%) x Cc

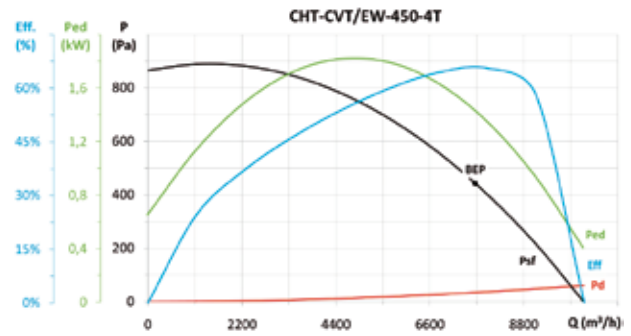

MC	EC	SR	Cc	η_e (%)*	N	[kW]	[m³/h]	[Pa]	[rpm]	VSD
C	S	1,00	1,08	70,8%	79,7	1,434	7663	443	1410	INCLUDED

* η_e (%) = Eff. (%) x Cc

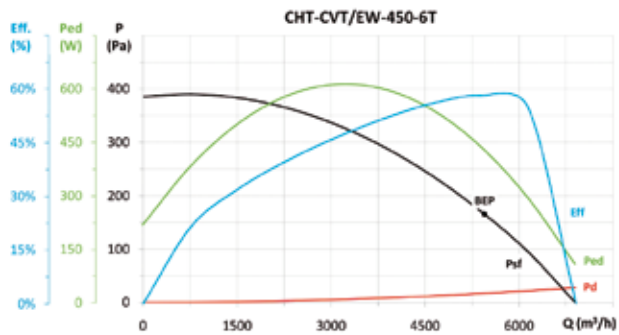

MC	EC	SR	Cc	η_e (%)*	N	[kW]	[m³/h]	[Pa]	[rpm]	VSD
C	S	1,00	1,11	64,8%	79,2	0,430	5449	165	960	INCLUDED

* η_e (%) = Eff. (%) x Cc

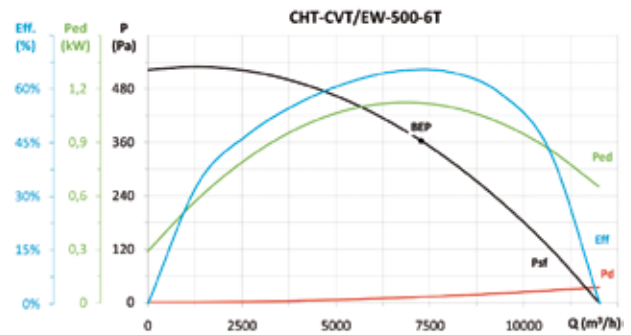

MC	EC	SR	Cc	η_e (%)*	N	[kW]	[m³/h]	[Pa]	[rpm]	VSD
C	S	1,00	1,08	71,0%	81,0	1,121	7265	364	960	INCLUDED

* η_e (%) = Eff. (%) x Cc



EFFICIENT WORK



HT-L/EW



MOTOR BRUSHLESS INDUSTRIAL E.C.



VARIADOR VELOCIDAD
VSD: Variador electrónico de velocidad.
· VSD1/B
· VSD3/B

Suministro incluido con el ventilador

CONTROL
Suministro como accesorio opcional

ALIMENTACIÓN
VSD1/B:
220-240 V 50/60 Hz
VSD3/B:
380-415 V 50/60 Hz

Extractores helicoidales de tejado, con base plana, equipados con motor Brushless industrial E.C.

Ventilador:

- Base soporte en chapa de acero galvanizada.
- Hélice en poliamida 6 reforzada con fibra de vidrio.
- Rejilla de protección antipajaros.
- Sombrero deflector anti lluvia en chapa de acero, con protección anticorrosiva.
- Dirección aire motor-hélice.

Motor y variador electrónico:

- Motores brushless industriales E.C. de muy alta eficiencia, equipados con variador electrónico de velocidad (VSD), regulable mediante señal externa de control 0-10 V.
- Se recomienda instalar el variador electrónico de velocidad (VSD) fuera de la zona de trabajo.
- La señal externa puede suministrarse a través de un control manual o automático con salida 0-10 V.
- Variador electrónico de velocidad (VSD), disponibles con entrada monofásica 220-240 V 50/60 Hz (Tipo VSD1/B) o trifásica 380-415 V 50/60 Hz (Tipo VSD3/B).

- Por defecto se entrega el variador electrónico de velocidad (VSD) programado a velocidad constante.
- Temperatura de trabajo ventilador: -25 °C +60 °C.
- Temperatura de trabajo (VSD): -25 °C +50 °C.

Acabado:

- Anticorrosivo en resina de poliéster polimerizada a 190 °C, previo desengrase con tratamiento nanotecnológico libre de fosfatos.

Bajo demanda:

- Posibilidad de suministro como VENTILADORES DE IMPULSIÓN.
- Hélice versión AL en fundición de aluminio.

Código de pedido con suministro de variador electrónico (VSD) incluido

HT-L/EW — 25 — 4 — B — T — D

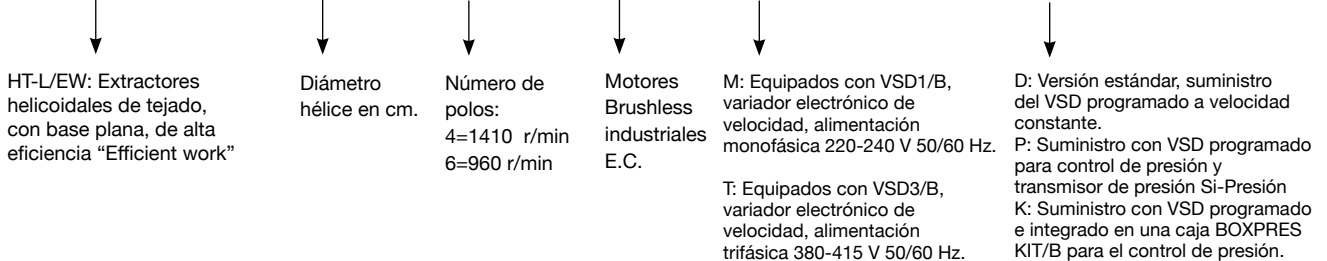

Características técnicas

Modelo	Velocidad min/max (r/min)	VSD monofásico 230 V 50/60 Hz		VSD trifásico 400 V 50/60 Hz		Potencia eléctrica máxima (W)	Caudal máximo min/max (m³/h)	Nivel de presión sonora		Peso aprox. (Kg)
		Intensidad máxima entrada (A)	Modelo VSD	Intensidad máxima entrada (A)	Modelo VSD			Aspiración min/max	Descarga min/max	
HT-L/EW-25-4	300 / 1410	1,44	VSD1/B-0.37	0,42	VSD3/B-0.75	175	230 / 1080	7 / 41	6 / 40	12,5
HT-L/EW-31-4	300 / 1410	1,44	VSD1/B-0.37	0,42	VSD3/B-0.75	175	385 / 1800	13 / 47	12 / 46	13,5
HT-L/EW-35-4	300 / 1410	1,44	VSD1/B-0.37	0,42	VSD3/B-0.75	175	555 / 2600	14 / 48	13 / 47	17,5
HT-L/EW-40-4	300 / 1410	2,79	VSD1/B-0.37	0,82	VSD3/B-0.75	340	980 / 4600	17 / 51	16 / 50	21
HT-L/EW-45-4	300 / 1410	3,96	VSD1/B-0.37	0,93	VSD3/B-0.75	450	1385 / 6500	21 / 55	20 / 54	30,5
HT-L/EW-50-4	300 / 1410	5,82	VSD1/B-0.75	1,37	VSD3/B-1.5	660	1810 / 8500	25 / 59	23 / 57	39
HT-L/EW-56-4	300 / 1410	7,94	VSD1/B-0.75	1,87	VSD3/B-1.5	905	2085 / 9800	27 / 61	23 / 57	37
HT-L/EW-56-6	300 / 960	2,93	VSD1/B-0.37	0,68	VSD3/B-0.75	330	2065 / 6600	23 / 48	21 / 46	46
HT-L/EW-63-4	300 / 1410	11,25	VSD1/B-0.75	2,65	VSD3/B-1.5	1295	2980 / 14000	29 / 63	25 / 59	65,8
HT-L/EW-63-6	300 / 960	4,28	VSD1/B-0.75	1,00	VSD3/B-1.5	480	2875 / 9200	27 / 52	24 / 49	61,8

Características acústicas a velocidad máxima

Los valores indicados, se determinan mediante medidas de nivel de presión y potencia sonora en dB (A) obtenidas en campo libre a una distancia de 6 mts.

Espectro de potencia sonora Lw(A) en dB(A) banda de frecuencia en [Hz]

Aspiración								Descarga								
Modelo	63	125	250	500	1000	2000	4000	8000	63	125	250	500	1000	2000	4000	8000
HT-L/EW-25-4	27	37	54	54	62	58	51	42	26	36	53	53	61	57	50	41
HT-L/EW-31-4	33	43	60	60	68	64	57	48	32	42	59	59	67	63	56	47
HT-L/EW-35-4	34	44	61	61	69	65	58	49	33	43	60	60	68	64	57	48
HT-L/EW-40-4	28	45	57	65	70	70	66	59	27	44	56	64	69	69	65	58
HT-L/EW-45-4	32	49	61	69	74	74	70	63	30	47	59	67	72	72	68	61
HT-L/EW-50-4	36	53	65	73	78	78	74	67	34	51	63	71	76	76	72	65
HT-L/EW-56-4	38	55	67	75	80	80	76	69	34	51	63	71	76	76	72	65
HT-L/EW-56-6	25	42	54	62	67	67	63	56	23	40	52	60	65	65	61	54
HT-L/EW-63-4	40	57	69	77	82	82	78	71	36	53	65	73	78	78	74	67
HT-L/EW-63-6	29	46	58	66	71	71	67	60	26	43	55	63	68	68	64	57

Dimensiones mm

Modelo	A	B	C	D	E	ØF	G	H	ØI	ØJ
HT-L/EW-25-4	400	176	44	40	140	620	450	360	12	346
HT-L/EW-31-4	423	176	67	40	140	620	500	410	12	416
HT-L/EW-35-4	472	228	64	40	140	770	560	450	12	486
HT-L/EW-40-4	478	228	82	40	128	770	630	530	12	536
HT-L/EW-45-4	512	266	88	50	108	960	710	590	12	596
HT-L/EW-50-4	558	296	83	50	129	1090	800	680	12	676
HT-L/EW-56-4	590	296	117	40	137	1090	900	750	14	758
HT-L/EW-56-6	589	296	117	40	136	1090	900	750	14	758
HT-L/EW-63-4	714	357	136	40	182	1285	1000	850	14	735
HT-L/EW-63-6	667	357	136	40	135	1285	1000	850	14	735

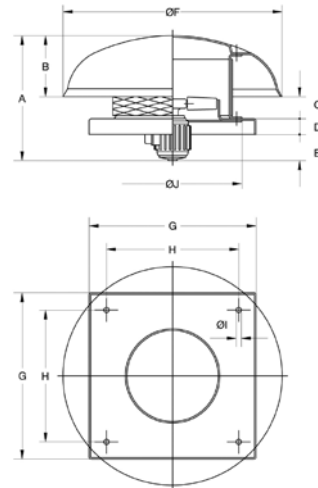

Accesorios

Ver apartado accesorios.



INT



BTUB



MS



PA



OP



S



BS

BSS UNIDADES DE CONTROL Y SENSORES



Erp. Curvas características y datos ErP

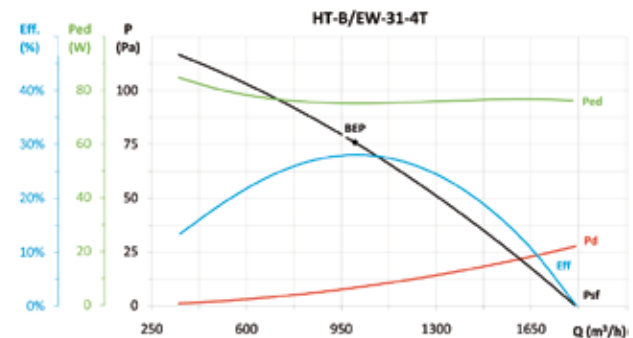
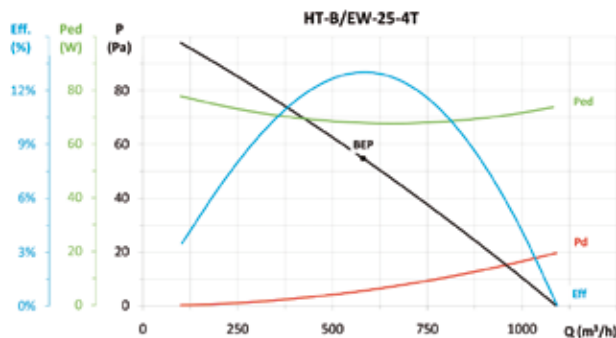



EFFICIENT WORK



Erp. Curvas características y datos ErP

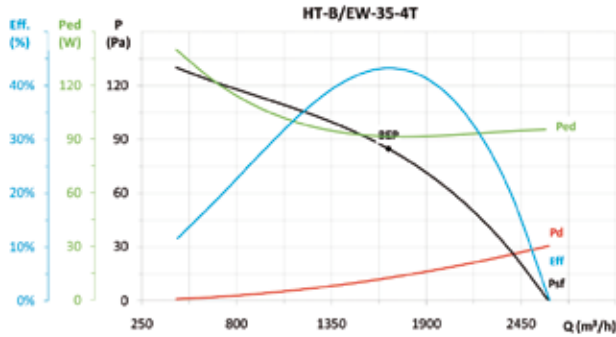

MC	EC	SR	Cc	η_e (%)*	N	[kW]	[m³/h]	[Pa]	[rpm]	VSD
A	S	-	-	-	-	0,091	1681	85	1410	INCLUDED

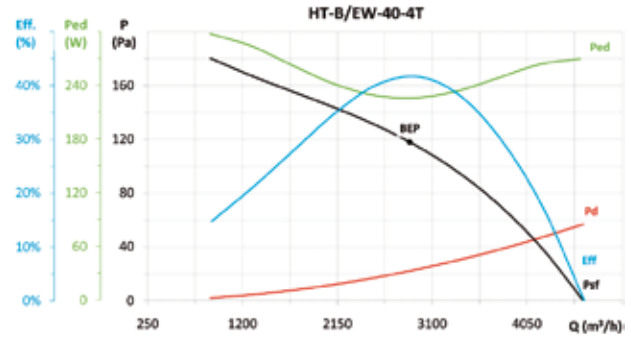

MC	EC	SR	Cc	η_e (%)*	N	[kW]	[m³/h]	[Pa]	[rpm]	VSD
A	S	1,00	1,13	47,2%	57,7	0,226	2875	118	1410	INCLUDED

* η_e (%) = Eff. (%) x Cc

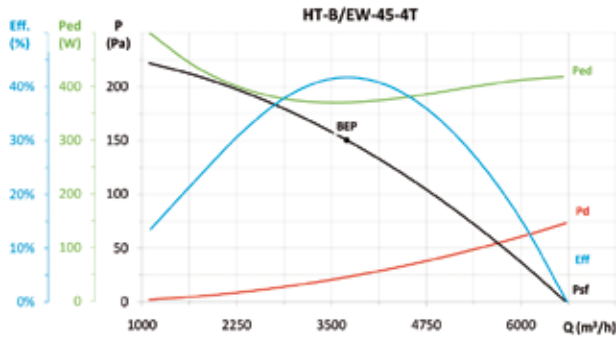

MC	EC	SR	Cc	η_e (%)*	N	[kW]	[m³/h]	[Pa]	[rpm]	VSD
A	S	1,00	1,12	46,7%	55,7	0,370	3701	150	1410	INCLUDED

* η_e (%) = Eff. (%) x Cc

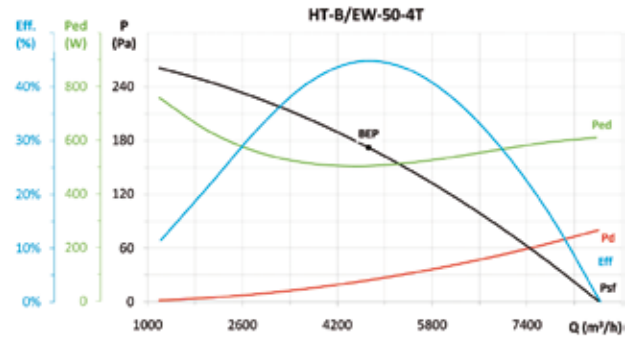

MC	EC	SR	Cc	η_e (%)*	N	[kW]	[m³/h]	[Pa]	[rpm]	VSD
A	S	1,00	1,11	49,6%	57,8	0,505	4727	172	1410	INCLUDED

* η_e (%) = Eff. (%) x Cc

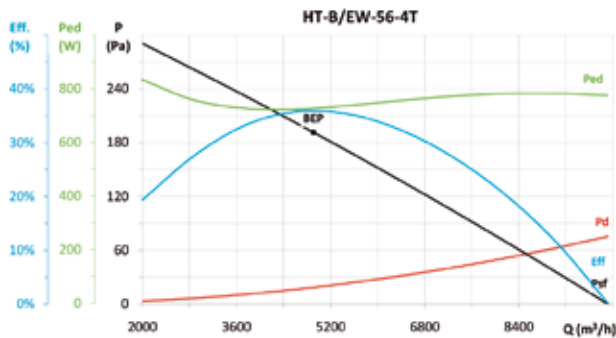

MC	EC	SR	Cc	η_e (%)*	N	[kW]	[m³/h]	[Pa]	[rpm]	VSD
A	S	1,00	1,10	39,4%	46,6	0,727	4907	192	1410	INCLUDED

* η_e (%) = Eff. (%) x Cc

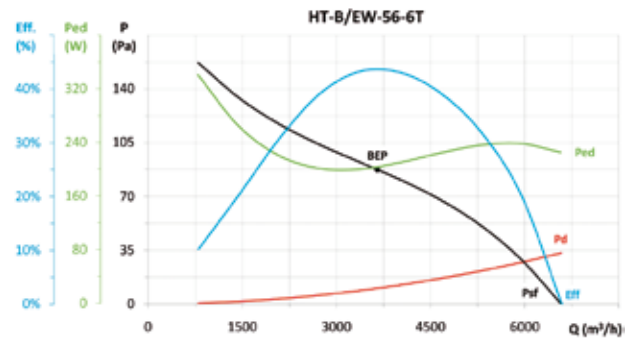

MC	EC	SR	Cc	η_e (%)*	N	[kW]	[m³/h]	[Pa]	[rpm]	VSD
A	S	1,00	1,14	49,6%	60,3	0,203	3651	87	960	INCLUDED

* η_e (%) = Eff. (%) x Cc

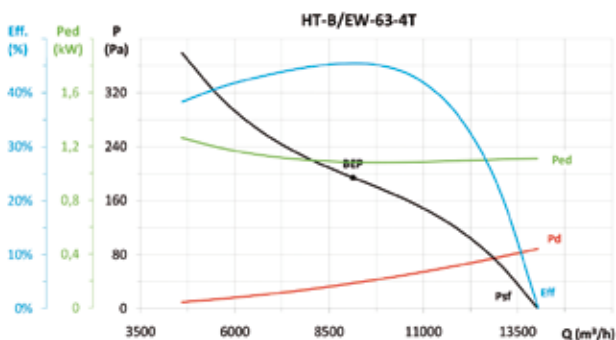

MC	EC	SR	Cc	η_e (%)*	N	[kW]	[m³/h]	[Pa]	[rpm]	VSD
C	S	1,00	1,09	49,4%	55,5	1,083	9132	194	1410	INCLUDED

* η_e (%) = Eff. (%) x Cc

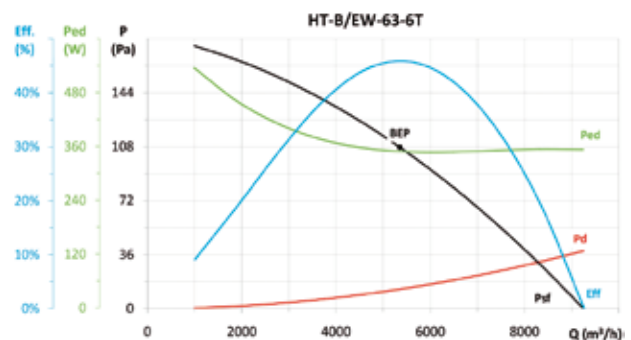

MC	EC	SR	Cc	η_e (%)*	N	[kW]	[m³/h]	[Pa]	[rpm]	VSD
A	S	1,00	1,12	51,4%	60,6	0,349	5352	108	960	INCLUDED

* η_e (%) = Eff. (%) x Cc

HT/EW

MOTORES TRIFÁSICOS DE ALTA Eficiencia IE3

VARIADOR VELOCIDAD
 VSD: Variador electrónico de velocidad.
 . VSD1/A-RFM
 . VSD3/A-RFT
 Suministro según pedido

CONTROL
 Suministro como accesorio opcional

ALIMENTACIÓN
 VSD31A-RFT:
 220-240 V 50/60 Hz
 VSD3/A-RFT:
 380-415 V 50/60 Hz

Extractores helicoidales de tejado, con base plana, equipados con motor asíncrono de alta eficiencia IE3 regulable electrónicamente.

Ventilador:

- Base soporte en chapa de acero galvanizada.
- Hélice en poliamida 6 reforzada con fibra de vidrio, excepto modelos 100 de 4 polos en aluminio.
- Rejilla de protección antipajaros.
- Sombrerete deflector antilluvia en poliéster, excepto modelo 71 en chapa de acero con protección anticorrosiva.
- Dirección aire motor-hélice.

Motor y variador electrónico:

- Motores eficiencia IE3, regulables electrónicamente.
- Se suministrará el variador de velocidad VSD según pedido.
- Variador electrónico de velocidad (VSD) regulable mediante señal externa de 0-10 V.
- Se recomienda instalar filtros senoidales entre ventilador y variador electrónico de velocidad (VSD), cuando haya gran distancia entre ellos.
- Variador electrónico de velocidad (VSD), disponibles con entrada monofásica 220-240 V 50/60 Hz hasta 3cv (Tipo VSD1/A-RFM) o con entrada trifásica 380-415 V 50/60 Hz (Tipo VSD3/A-RFT).
- Por defecto se entrega el variador electrónico de velocidad (VSD) programado a velocidad constante.

Temperatura de trabajo ventilador:

- -25 °C +60 °C.
- Temperatura de trabajo (VSD): -25 °C +50 °C.
- Motores clase F, con rodamientos a bolas, protección IP55.
- Trifásicos 230/400 V 50 Hz (hasta 5,5 CV) y 400/690 V 50 Hz. (potencias superiores a 5,5 CV)

Bajo demanda:

- Posibilidad de suministro como VENTILADORES DE IMPULSIÓN.
- Hélice versión AL en fundición de aluminio.

Código de pedido del ventilador

HT/EW — 71 — 4T — 2 — IE3

HT/EW: Extractores helicoidales de tejado, con base plana, de alta eficiencia "Efficient work"

Diámetro hélice en cm.

 Número de polos:
 4=1410 r/min
 6=960 r/min

Potencia motor en CV

Motores trifásicos IE3

HT/EW — 71 — 4T — 2 — IE3 — VSD1 — D

HT/EW: Extractores helicoidales de tejado, con base plana, de alta eficiencia "Efficient work"

Diámetro hélice en cm.

 Número de polos:
 4=1410 r/min
 6=960 r/min

Potencia motor en CV

Motores trifásicos IE3

VSD1: Equipados con VSD1/A-RFM, variador electrónico de velocidad, alimentación monofásica 220-240 V 50/60 Hz.

VSD3: Equipados con VSD3/A-RFT, variador electrónico de velocidad, alimentación trifásica 380-415 V 50/60 Hz.

 D: Versión estándar, suministro del VSD programado a velocidad constante.
 P: Suministro con VSD programado para control de presión y transmisor de presión Si-Presión
 K: Suministro con VSD programado e integrado en una caja BOXPRES KIT para el control de presión. Disponible sólo para ventiladores con potencia motor inferior o igual a 2,2 kW.

Accesorios

Ver apartado accesorios.





EFFICIENT WORK



Características técnicas

Modelo	Velocidad min/max (r/min)	VSD monofásico 230 V 50/60 Hz		VSD trifásico 400 V 50/60 Hz		Intensidad máxima Motor 50 Hz			Potencia instalada (kW)	Caudal máximo min/max (m³/h)	Nivel de presión sonora		Peso aprox. (Kg)
		Intensidad máxima entrada (A)	Modelo VSD	Intensidad máxima entrada (A)	Modelo VSD	230V	400V	690V			Aspiración min/max Lp dB(A)	Descarga min/max Lp dB(A)	
HT/EW-71-4T-2	575/1440	15,78	VSD1/A-RFM-2	4,38	VSD3/A-RFT-2	5,41	3,11	-	1,50	7190 / 18000	49 / 69	47 / 67	64,0
HT/EW-71-6T-0,75	370/925	6,90	VSD1/A-RFM-1	1,92	VSD3/A-RFT-1	2,52	1,45	-	0,55	4880 / 12200	38 / 58	36 / 56	64,9
HT/EW-80-4T-3	575/1435	23,15	VSD1/A-RFM-3	6,43	VSD3/A-RFT-3	7,93	4,56	-	2,20	10500 / 26200	53 / 73	50 / 70	87,8
HT/EW-80-6T-1,5	380/945	12,43	VSD1/A-RFM-2	3,45	VSD3/A-RFT-2	4,68	2,69	-	1,10	7240 / 18000	44 / 64	41 / 61	81,8
HT/EW-90-4T-4	575/1440	-	-	7,20	VSD3/A-RFT-5.5	10,7	6,15	-	3,00	12580 / 31500	57 / 77	54 / 74	94,0
HT/EW-90-6T-2	380/950	16,64	VSD1/A-RFM-2	4,62	VSD3/A-RFT-2	6,43	3,7	-	1,50	8480 / 21200	48 / 68	45 / 65	91,0
HT/EW-100-4T-7,5	585/1465	-	-	12,81	VSD3/A-RFT-7.5	-	10,3	5,97	5,50	14775 / 37000	60 / 80	57 / 77	114,0
HT/EW-100-4T-10	585/1465	-	-	17,32	VSD3/A-RFT-10	-	13,9	8,06	7,50	17570 / 44000	64 / 84	61 / 81	125,0
HT/EW-100-6T-2	380/950	16,64	VSD1/A-RFM-2	4,62	VSD3/A-RFT-2	6,43	3,7	-	1,50	10000 / 25000	51 / 71	48 / 68	102,0
HT/EW-100-6T-3	380/950	23,83	VSD1/A-RFM-3	6,62	VSD3/A-RFT-3	9,08	5,22	-	2,20	11280 / 28200	55 / 75	52 / 72	106,0

Características acústicas a velocidad máxima

Los valores indicados, se determinan mediante medidas de nivel de presión y potencia sonora en dB (A) obtenidas en campo libre a una distancia de 6 mts.

Espectro de potencia sonora Lw(A) en dB(A) banda de frecuencia en [Hz]

Modelo	Aspiración								Descarga							
	63	125	250	500	1000	2000	4000	8000	63	125	250	500	1000	2000	4000	8000
HT/EW-71-4T	46	63	75	83	88	88	84	77	44	61	73	81	86	86	82	75
HT/EW-71-6T	35	52	64	72	77	77	73	66	33	50	62	70	75	75	71	64
HT/EW-80-4T	57	78	85	90	93	89	82	71	54	75	82	87	90	86	79	68
HT/EW-80-6T	48	69	76	81	84	80	73	62	45	66	73	78	81	77	70	59
HT/EW-90-4T	61	82	89	94	97	93	86	75	58	79	86	91	94	90	83	72
HT/EW-90-6T	52	73	80	85	88	84	77	66	49	70	77	82	85	81	74	63
HT/EW-100-4T-7,5	64	85	92	97	100	96	89	78	61	82	89	94	97	93	86	75
HT/EW-100-4T-10	68	89	96	101	104	100	93	82	65	86	93	98	101	97	90	79
HT/EW-100-6T-2	55	76	83	88	91	87	80	69	52	73	80	85	88	84	77	66
HT/EW-100-6T-3	59	80	87	92	95	91	84	73	56	77	84	89	92	88	81	70

Dimensiones mm

Modelo	A	B	C	D	E	ØF	G	H	ØI	ØJ
HT/EW-71-4T	740	357	166	40	178	1285	1000	850	14	815
HT/EW-71-6T	689	357	166	40	178	1285	1000	850	14	815
HT/EW-80-4T	840	357	244	50	189	1285	1150	1000	14	905
HT/EW-80-6T	804	357	244	50	153	1285	1150	1000	14	905
HT/EW-90-4T	892	440	213	50	189	1580	1150	1000	14	1020
HT/EW-90-6T	896	440	213	50	193	1580	1150	1000	14	1020
HT/EW-100-4T	997	440	284	50	223	1580	1250	1100	14	1120
HT/EW-100-6T-2	940	440	284	50	166	1580	1250	1100	14	1120
HT/EW-100-6T-3	957	440	284	50	183	1580	1250	1100	14	1120

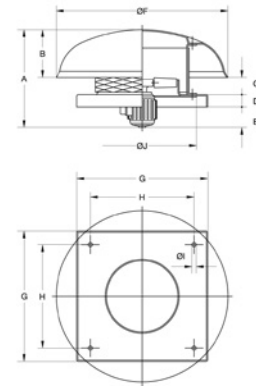

Erp. Curvas características y datos ErP

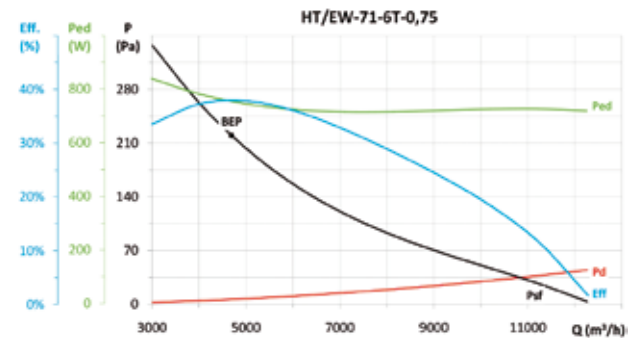
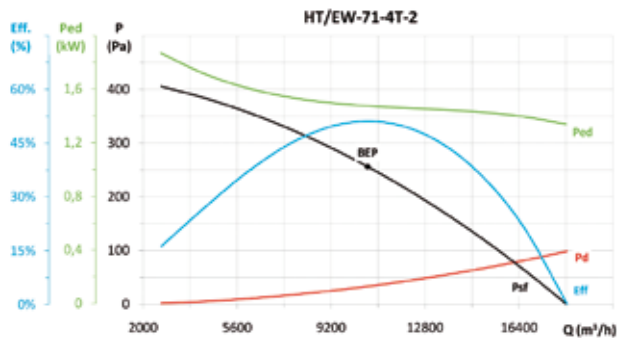

MC	EC	SR	Cc	η _e (%)*	N	[kW]	[m³/h]	[Pa]	[rpm]	VSD
C	S	1,00	1,08	55,0%	60,3	1,476	10600	256	1451	NECESSARY

*η_e (%) = EFF. (%) x Cc

MC	EC	SR	Cc	η _e (%)*	N	[kW]	[m³/h]	[Pa]	[rpm]	VSD
C	S	1,00	1,10	41,6%	48,7	0,755	4694	220	929	NECESSARY

*η_e (%) = EFF. (%) x Cc

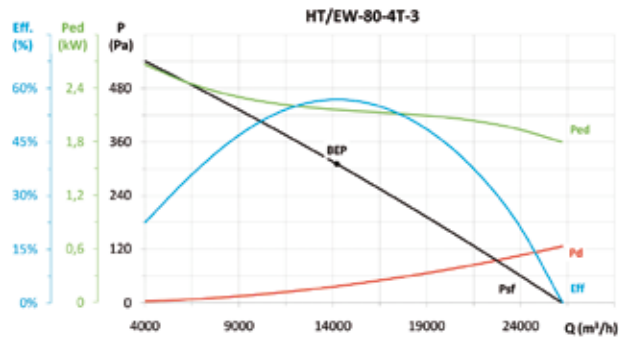
Erp. Curvas características y datos ErP

MC	EC	SR	Cc	η_b (%)*	N	[kW]	[m³/h]	[Pa]	[rpm]	VSD
C	S	1,00	1,06	60,5%	64,7	2,159	14211	311	1447	NECESSARY

* η_e (%) = Eff. (%) x Cc

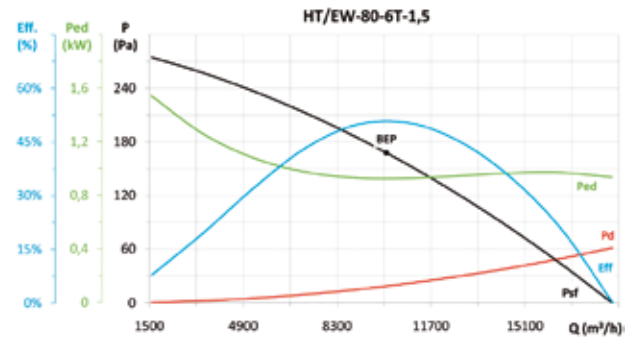

MC	EC	SR	Cc	η_b (%)*	N	[kW]	[m³/h]	[Pa]	[rpm]	VSD
C	S	1,09	1,09	55,4%	62,0	0,924	10084	168	964	NECESSARY

* η_e (%) = Eff. (%) x Cc

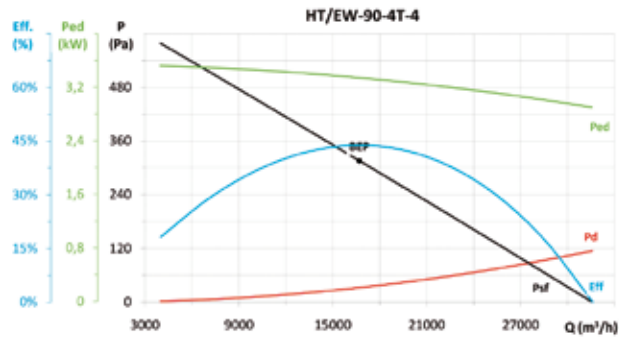

MC	EC	SR	Cc	η_b (%)*	N	[kW]	[m³/h]	[Pa]	[rpm]	VSD
C	S	1,00	1,05	46,1%	49,1	3,342	16694	316	1444	NECESSARY

* η_e (%) = Eff. (%) x Cc

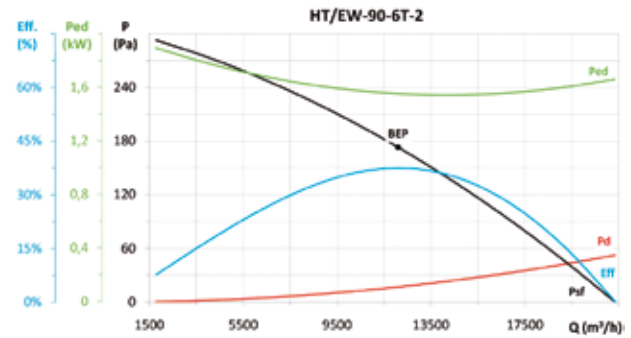

MC	EC	SR	Cc	η_b (%)*	N	[kW]	[m³/h]	[Pa]	[rpm]	VSD
C	S	1,00	1,07	40,3%	45,4	1,552	12101	173	959	NECESSARY

* η_e (%) = Eff. (%) x Cc

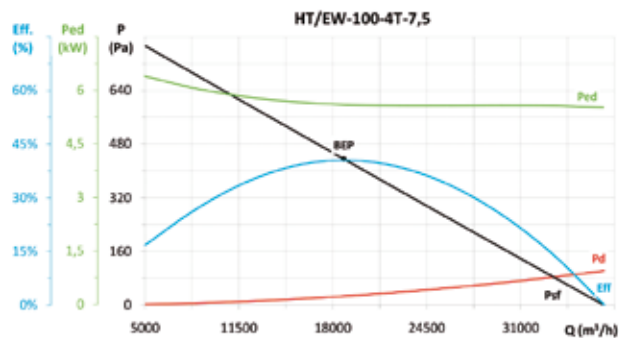

MC	EC	SR	Cc	η_b (%)*	N	[kW]	[m³/h]	[Pa]	[rpm]	VSD
C	S	1,00	1,07	41,5%	46,2	1,754	13902	176	954	NECESSARY

* η_e (%) = Eff. (%) x Cc

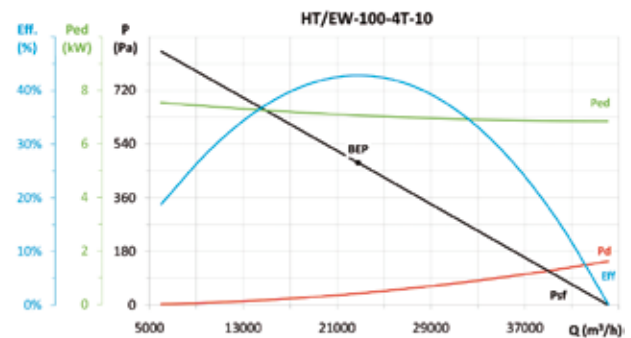

MC	EC	SR	Cc	η_b (%)*	N	[kW]	[m³/h]	[Pa]	[rpm]	VSD
C	S	1,00	1,06	37,8%	41,8	2,328	15556	192	958	NECESSARY

* η_e (%) = Eff. (%) x Cc

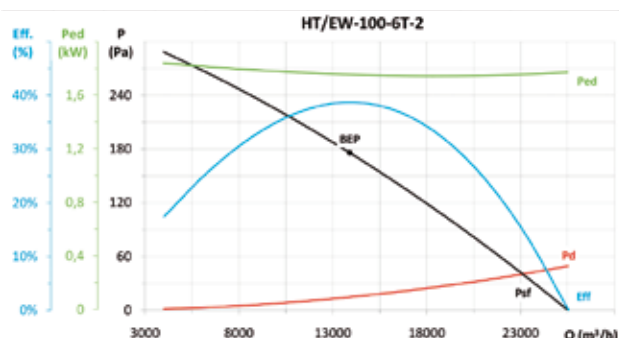

MC	EC	SR	Cc	η_b (%)*	N	[kW]	[m³/h]	[Pa]	[rpm]	VSD
C	S	1,00	1,06	37,8%	41,8	2,328	15556	192	958	NECESSARY

* η_e (%) = Eff. (%) x Cc

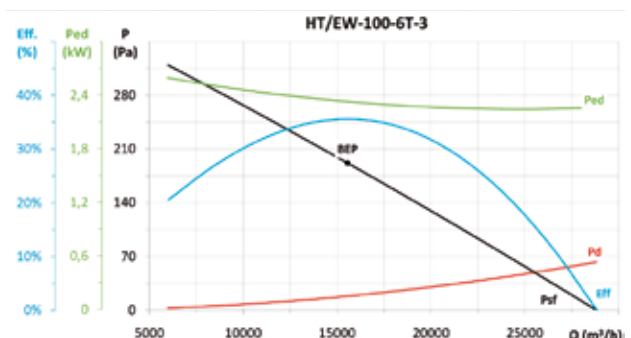

MC	EC	SR	Cc	η_b (%)*	N	[kW]	[m³/h]	[Pa]	[rpm]	VSD
C	S	1,00	1,06	37,8%	41,8	2,328	15556	192	958	NECESSARY

* η_e (%) = Eff. (%) x Cc



EFFICIENT WORK



KIT SOBREPRESIÓN

El sistema de presurización de escaleras, vías de escape o de confinamiento, permite controlar de forma automática el caudal y mantener una presión diferencial de 50 Pa en una sola etapa, según norma UNE EN 12101-6-2006

KIT SOBREPRESIÓN DE ESCALERAS
Para equipos trifásicos



KIT SOBREPRESIÓN DE ESCALERAS
Para equipos monofásicos



KIT SOBREPRESIÓN CON
VENTILADOR DE RESERVA



KIT SOBREPRESIÓN DE ESCALERAS

- Kit sobrepresión de escaleras, formado por un cuadro de control (BOXPRES KIT) y unidades de impulsión (CJHCH o CJBD), para la presurización de las escaleras y rutas de escape. También disponible para equipos monofásicos NEOLINEO Y CJBC.

KIT SOBREPRESIÓN CON VENTILADOR DE RESERVA

- Kit de sobrepresión con ventilador de reserva, formado por un cuadro de control (BOXPRES KIT II), que incorpora un sistema de conmutación automático para mantener la sobrepresión en caso de fallo del ventilador principal, y unidades de impulsión de aire con ventilador de reserva serie TWIN o CJHCH/DUPLEX.

BOXPRES



- Fácil instalación
- Solución compacta y autónoma
- Mantenimiento preventivo
- Fácil puesta en marcha
- Instalación segura y funcional



- El buen funcionamiento de los sistemas de presurización, depende no solo del buen diseño de los mismos, sino también de la buena regulación que realice el sistema, por lo que es de vital importancia contar con elementos de regulación calibrados y de gran precisión, que permitan simultanear las dos situaciones presentes en caso de incendio, de forma rápida y estable.
- El cuadro de control BOXPRES, además de cumplir con las máximas exigencias, simplifica al máximo el trabajo del instalador.

Incluye:

- Variador de frecuencia programado a 50 Pa
- Sonda de presión diferencial
- Magneto térmico
- Led de línea y fallo
- Pulsador de chequeo

BOXPRES, es un equipo con todas sus conexiones entre sí realizadas y probadas

- Listo para funcionar y desempeñar su función sobre el control de la presión de la instalación.
- Posibilidad de chequeo de la instalación para evitar fallos
- Solo se debe conectar la línea de alimentación, el ventilador de impulsión y la señal de incendio.

Los cuadros para equipos monofásicos incluyen:

- Regulador de tensión programado a 50 Pa
- Sonda de presión diferencial externa al equipo.

Código de pedido

KIT SOBREPRESIÓN — 7.100

↓

Kit sobrepresión: Conjunto de sobrepresión para escaleras
Kit sobrepresión II: Conjunto de sobrepresión con ventilador de reserva

↓

Caudal máximo



Características técnicas

Modelo	Alimentación	Salida	Unidad de impulsión	Caudal (m³/h)	Nivel sonoro irradiado* dB(A)
KIT SOBREPRESION-1060-LED	230 Vac II	230 Vac II	NEOLINEO-200	1060	38
KIT SOBREPRESION-2300-LED	230 Vac II	230 Vac II	NEOLINEO-315	2300	47
KIT SOBREPRESION-2880-LED	230 Vac II	230 Vac II	CJBC-2828-6M 1/3	2880	61
KIT SOBREPRESION-7100-LED	230 Vac II	230 Vac III	CJHCH-45-4T-0,5	7100	55
KIT SOBREPRESION-7800-LED	230 Vac II	230 Vac III	CJBD-3333-6T-1,5	7800	55
KIT SOBREPRESION-12900-LED	230 Vac II	230 Vac III	CJHCH-56-4T-1	12900	60
KIT SOBREPRESION-17000-LED	230 Vac II	230 Vac III	CJHCH-63-4T-1,5	17000	61
KIT SOBREPRESION-7100-BOX	400 Vac III	400 Vac III	CJHCH-45-4T-0,5	7100	55
KIT SOBREPRESION-7800-BOX	400 Vac III	400 Vac III	CJBD-3333-6T-1,5	7800	55
KIT SOBREPRESION-12900-BOX	400 Vac III	400 Vac III	CJHCH-56-4T-1	12900	60
KIT SOBREPRESION-17000-BOX	400 Vac III	400 Vac III	CJHCH-63-4T-1,5	17000	61
KIT SOBREPRESION II-6240-BOX	400 Vac III	400 Vac III	TWIN-12/12-6T-1,5	6240	55
KIT SOBREPRESION II-9520-BOX	400 Vac III	400 Vac III	TWIN-15/15-6T-3	9520	54
KIT SOBREPRESION II-12900-BOX	400 Vac III	400 Vac III	CJHCH/DUPLEX-56-4T-1-H	12900	60
KIT SOBREPRESION II-17000-BOX	400 Vac III	400 Vac III	CJHCH/DUPLEX-63-4T-1,5-H	17000	61
SONDA TPDA SI-PRESIÓN c/DISPLAY					
SONDA TPDA 984M.523 P04					
SONDA TPDA 984M.523 P14 LED					
BOXPRES KIT-3A 230Vac	230 Vac II	230 Vac II			
BOXPRES KIT-10A 230Vac	230 Vac II	230 Vac II			
BOXPRES KIT-0,75KW 230Vac	230 Vac II	230 Vac III			
BOXPRES KIT-1,5KW 230Vac	230 Vac II	230 Vac III			
BOXPRES KIT-0,75KW 400Vac	400 Vac III	400 Vac III			
BOXPRES KIT-1,5KW 400Vac	400 Vac III	400 Vac III			
BOXPRES KIT-2,2KW 400Vac	400 Vac III	400 Vac III			
BOXPRES KIT II - 1,5KW 400Vac	400 Vac III	400 Vac III			
BOXPRES KIT II - 2,2KW 400Vac	400 Vac III	400 Vac III			

Dimensiones mm

CJHCH

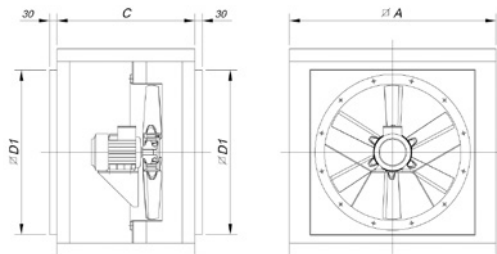

Modelo	∅A	C	∅D1
CJHCH-40/45/50	700	550	565
CJHCH-56/63	825	550	690

CJBD

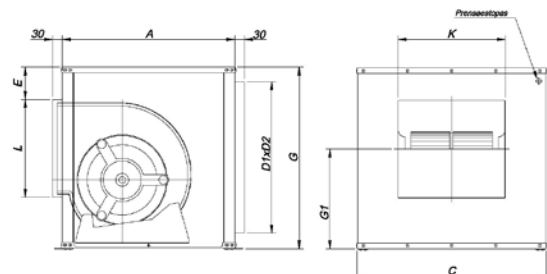

Modelo	Equiv. pulgadas	A	B	C	E	D1xD2	G1	L	K
CJBD-3333	12/12	650	650	700	92	556X606	379	358	400



EFFICIENT WORK



Dimensiones mm

TWIN

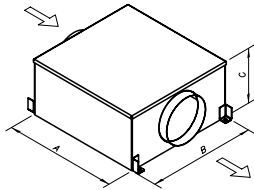

Modelo	A	B	C
TWIN-12/12	1103	1139	610
TWIN 15/15	1279	1639	698

CJHCH/DUPLEX

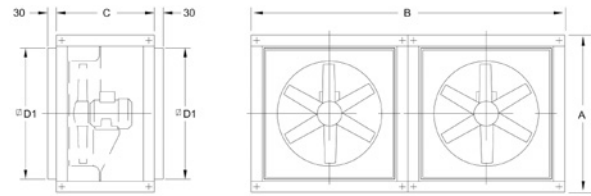

Modelo	ØA	B	C	ØD1
CJHCH/DUPLEX-56/63	825	1650	550	690

NEOLINEO

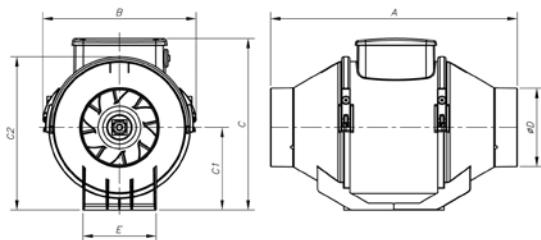

Modelo	A	B	C	C1	C2	øD	E
NEOLINEO-200	300	234,5	260,5	125,5	235	196	140
NEOLINEO-315	448	361,5	392,5	188,5	359	312	220,5

CJBC

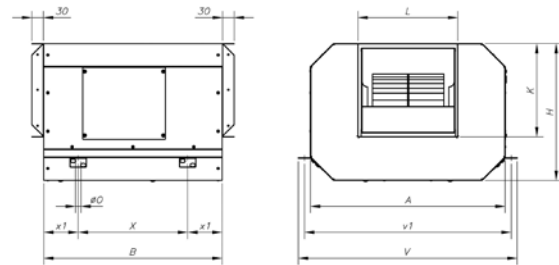

Modelo	A	B	H	K	L	øO	V	v1	X	x1
CJBC-2828-6M-1/3	696	645	460	290	320	15	755	725	445	100

BOXPRESS KIT SOBREPRESIÓN

Características técnicas y dimensiones

Modelo	Potencia kW	Alimentación (V/Hz)	Salida (V/Hz)	Intensidad salida (A)	Tamaño	Medidas (largo x ancho x fondo)
BOXPRES KIT-3A 230Vac	-	230 Vac II	230 Vac II	3	-	255 x 170 x 140 mm
BOXPRES KIT-10A 230Vac	-	230 Vac II	230 Vac II	10	-	255 x 170 x 140 mm
BOXPRES KIT-0,75kW 230Vac	0,75	230 V II / 50Hz	230 V III / 50Hz	4,3	1	270 x 270 x 170 mm
BOXPRES KIT-1,5kW 230Vac	1,5	230 V II / 50Hz	230 V III / 50Hz	7	1	270 x 270 x 170 mm
BOXPRES KIT-0,75KW 400Vac	0,75	400 V III / 50Hz	400 V III / 50Hz	2,2	1	270 x 270 x 170 mm
BOXPRES KIT-1,5KW 400Vac	1,5	400 V III / 50Hz	400 V III / 50Hz	4,1	1	270 x 270 x 170 mm
BOXPRES KIT-2,2KW 400Vac	2,2	400 V III / 50Hz	400 V III / 50Hz	5,8	2	360 x 360 x 205 mm

BOXPRES KIT-3A / KIT-10A

Conexión alimentación y motor

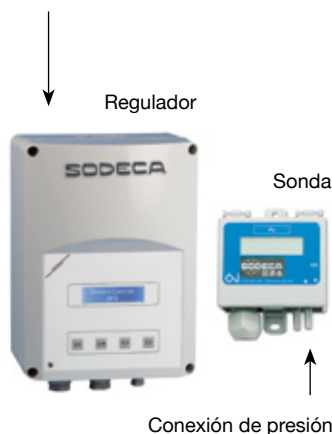

Prensaestopas de entrada cable a equipo Tamaño 1

M 20 x 1,5mm
Conexión Alimentación y motor
M 12 x 1,5mm
Conexión Señal Incendio
Conexión de presión



Prensaestopas de entrada cable a equipo Tamaño 2

M 20 x 1,5mm
Conexión Alimentación y motor
M 12 x 1,5mm
Conexión Señal Incendio
Conexión de presión





BOXPRES KIT SOBREPRESIÓN II

Para equipos con ventilador de reserva.

Características técnicas y dimensiones

Modelo	Potencia kW	Alimentación (V/Hz)	Salida (V/Hz)	Intensidad salida (A)	Tamaño	Medidas (largo x ancho x fondo)
BOXPRES KIT II - 1,5KW 400Vac	1,5	400 V III / 50Hz	400 V III / 50Hz	4,1	1	270 x 270 x 170 mm
BOXPRES KIT II - 2,2KW 400Vac	2,2	400 V III / 50Hz	400 V III / 50Hz	5,4	2	360 x 360 x 205 mm

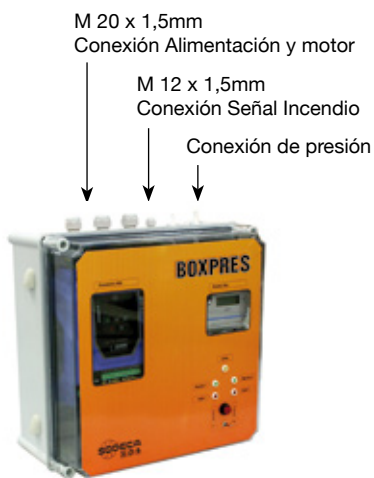
* Los dos motores nunca funcionan simultáneamente

**Prensaestopas de entrada cable a equipo
Tamaño 1**

**Prensaestopas de entrada cable a equipo
Tamaño 2**

Ejemplo de aplicación

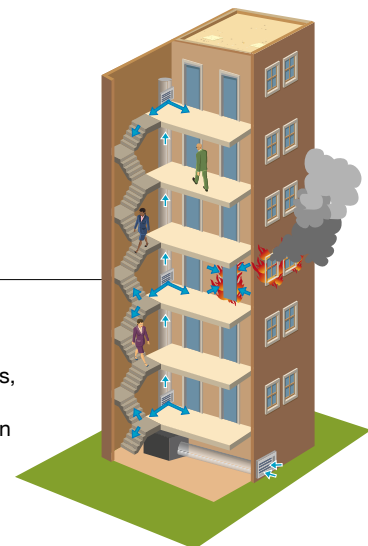
Método de control de humo por Sobrepresión, este sistema consiste en la presurización mediante inyección de aire en habitáculos que son utilizados como vías de escape de personas en caso de incendio, tales como cajas de escalera, pasillos, corredores, elevadores, etc. Sobre todo en edificios de altura con gran ocupación. Este método está basado en el control del humo mediante la velocidad del aire y la barrera artificial que crea la sobre presión del aire sobre el humo, para que este no pueda entrar en las vías de escape.





EFFICIENT WORK



ACCESORIOS

Variadores electrónicos de velocidad

VSD1/B VSD3/B



Variador electrónico de velocidad para motores Brushless

102

VSD1/A-RFM VSD3/A-RFT



Variador electrónico de velocidad para motores AC

102

Unidades de control y sensores

MTP010



Control de velocidad motor brushless 0-10V

103

SI-CO2



Detector de calidad de aire

103

SI-TEMP +HUMEDAD



Sensor de temperatura y humedad relativa con display

103

SI-FUENTE DE ALIMENTACIÓN



Fuente de alimentación 24V dc/ac

103

SI-PIR



Detector de presencia

103

SI-SMOKE



Detector de humo de tabaco

103

SI-TEMP



Sensor de temperatura

104

SI-PRESIÓN



Transmisor de presión

104

SI-TIMER



Temporizador

104

KIT CAUDAL CONSTANTE



Conjunto compuesto de transmisor de presión y convertidor de frecuencia

104

SI CONTROL PRESIÓN



Control de presión con sonda incorporada

104

SI-HUMEDAD



Sensor de humedad relativa

104

BOXPRES KIT BOXPRES KIT/B



105

En línea



DUO



Kits de entrada y salida



Rejillas rectangulares



Rejillas de protección serie SV



Rejillas de protección serie NEOLINE



Bocas de salida



Bocas de captación



Bocas de aspiración/impulsión



Persianas de sobrepresión



Rejillas circulares



Baterías eléctricas



Válvulas de mariposa



Compuertas antirretorno

117



Accesorios



Cajas de filtro de aire



C/FILTER/CL



Conducto de instalación en serie

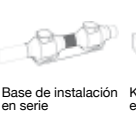

Base de instalación en serie



Kit de instalación en paralelo



SR



ARE



PSA

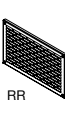

RR



TAC/CL



STUB



S

117

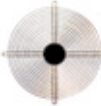

ACCESORIOS

<p>INT</p>  <p>Interruptores de seguridad paro-marcha, para cumplir la Norma UNE-EN 60204-1</p> <p>108</p>	<p>AET</p>  <p>Cuadro eléctrico de arranque estrella / triángulo y protección de ventiladores trifásicos</p> <p>108</p>	<p>PL</p>  <p>Persianas de sobrepresión</p> <p>108</p>	<p>P</p>  <p>Persianas de sobrepresión en aluminio</p> <p>108</p>	<p>R</p>  <p>Rejilla de protección para la aspiración de ventiladores helicoidales</p> <p>108</p>
<p>RI</p>  <p>Rejilla de protección para la impulsión de ventiladores helicoidales.</p> <p>109</p>	<p>RT</p>  <p>Rejilla de protección para la aspiración o impulsión de ventiladores helicoidales tubulares.</p> <p>109</p>	<p>RPA</p>  <p>Rejilla de protección para la aspiración de ventiladores centrifugos</p> <p>109</p>	<p>PV</p>  <p>Pabellón de aspiración con reja incorporada</p> <p>109</p>	<p>BTUB</p>  <p>Brida de acoplamiento para ventiladores helicoidales</p> <p>110</p>
<p>B</p>  <p>Brida de acoplamiento para ventiladores centrifugos</p> <p>110</p>	<p>BD</p>  <p>Brida de acoplamiento doble para ventiladores centrifugos</p> <p>110</p>	<p>BAC</p>  <p>Brida de acoplamiento doble y elástica para ventiladores helicoidales</p> <p>111</p>	<p>PS</p>  <p>Conjunto de pies soporte, para ventiladores tubulares.</p> <p>111</p>	<p>PSB</p>  <p>Conjunto de pies soporte, para ventiladores centrifugos de baja presión</p> <p>111</p>
<p>MS</p>  <p>Marco soporte para facilitar el montaje en obra</p> <p>111</p>	<p>TEJ</p>  <p>Tejadillos para intemperie</p> <p>111</p>	<p>VIS</p>  <p>Viseras de impulsión con rejilla de protección.</p> <p>112</p>	<p>PA</p>  <p>Placa de adaptación para montaje de accesorios, en extractores de tejado</p> <p>112</p>	<p>BS BSS</p>  <p>Base soporte elevada y base soporte elevada con silenciador</p> <p>112</p>
<p>PT PT/H</p>  <p>Obturadores de cierre automático para trabajo vertical o horizontal</p> <p>113</p>	<p>BIC</p>  <p>Brida de conversión de rectangular a circular, para ventiladores centrifugos</p> <p>113</p>	<p>ACE</p>  <p>Acoplamiento elástico para amortiguar vibraciones</p> <p>114</p>	<p>REG</p>  <p>Registro de regulación manual</p> <p>114</p>	<p>CJACUS</p>  <p>Cajas acústicas para ventiladores centrifugos</p> <p>114</p>
<p>OP</p>  <p>Obturadores de sobrepresión para extractores de tejado</p> <p>114</p>	<p>S</p>  <p>Silenciadores para acoplar a la aspiración o impulsión</p> <p>115</p>			



EFFICIENT WORK



Variadores electrónicos de velocidad



VSD1/B
VSD3/B

Variador electrónico de velocidad para motores Brushless

Características:

- Convertidores para la alimentación de motores síncronos Industrial Brushless y motores síncronos de reluctancia variable.
- Alimentación del convertidor:
 - Monofásico (VSD1/B): 220-240V 50/60 Hz
 - Trifásico (VSD3/B): 380-400V 50/60 Hz
- De acuerdo a las Directivas de Compatibilidad Electromagnética 92/31/CEE y 93/68/CEE y de acuerdo a la Directiva de Baja tensión 73/23/CEE
- Entrada paro/marcha para deshabilitar/habilitar el variador.
- Entrada 0-10V para el control de velocidad.
- Conexión a bus ModBus RTU disponible.

VSD1/B

Modelo	VSD1/B-0,37kW	VSD1/B-0,75kW	VSD1/B-1,5kW	VSD1/B-2,2kW
Intensidad máxima (A)	2,3	4,3	7,0	10,5
Potencia (kW)	0,37	0,75	1,5	2,2
Entrada				
Tipo entrada	Monofásica	Monofásica	Monofásica	Monofásica
Voltage (V)	220-240 V	220-240 V	220-240 V	220-240 V
Frecuencia (Hz)	50-60 Hz	50-60 Hz	50-60 Hz	50-60 Hz
Salida				
Tipo Salida	Trifásica	Trifásica	Trifásica	Trifásica
Voltage (V)	120-230 V	120-230 V	120-230 V	120-230 V
Frecuencia (Hz)	0-500 Hz	0-500 Hz	0-500 Hz	0-500 Hz
Refrigeración	Forzada	Forzada	Forzada	Forzada

VSD3/B

Modelo	VSD3/B-0,75kW	VSD3/B-1,5kW	VSD3/B-2,2kW
Intensidad máxima (A)	2,2	4,1	5,8
Potencia (kW)	0,75	1,5	2,2
Entrada			
Tipo entrada	Trifásica	Trifásica	Trifásica
Voltage (V)	380-480 V	380-480 V	380-480 V
Frecuencia (Hz)	50-60 Hz	50-60 Hz	50-60 Hz
Salida			
Tipo Salida	Trifásica	Trifásica	Trifásica
Voltage (V)	120-480 V	120-480 V	120-480 V
Frecuencia (Hz)	0-500 Hz	0-500 Hz	0-500 Hz
Refrigeración	Forzada	Forzada	Forzada



VSD1/A-RFM
VSD3/A-RFT

Variador electrónico de velocidad para motores AC

Características:

- Convertidores para la variación de velocidad mediante tensión y frecuencia, de ventiladores helicoidales y centrífugos con motores trifásicos asíncronos
- Alimentación del convertidor:
 - Monofásico (VSD1/B): 200-240V 50/60 Hz
 - Trifásico (VSD3/B): 380-480V 50/60 Hz
- De acuerdo a las Directivas de Compatibilidad Electromagnética 92/31/CEE y 93/68/CEE y de acuerdo a la Directiva de Baja tensión 73/23/CEE
- Entrada paro/marcha para deshabilitar/habilitar el variador.
- Entrada 0-10V para el control de velocidad.
- Conexión a bus ModBus RTU disponible.

VSD1/A-RFM

Modelo	VSD1/A-RFM-0,5	VSD1/A-RFM-1	VSD1/A-RFM-2	VSD1/A-RFM-3
Potencia (CV)	0,50	1,00	2,00	3,00
Potencia (kW)	0,37	0,75	1,50	2,20
Intensidad máxima(A)	2,3	4,3	7,0	10,5
Entrada				
Tipo entrada	Monofásica	Monofásica	Monofásica	Monofásica
Voltage (V)	200-240 V	200-240 V	200-240 V	200-240 V
Frecuencia (Hz)	50-60 Hz	50-60 Hz	50-60 Hz	50-60 Hz
Salida				
Tipo Salida	Trifásica	Trifásica	Trifásica	Trifásica
Voltage (V)	200-240 V	200-240 V	200-240 V	200-240 V
Frecuencia (Hz)	0-500 Hz	0-500 Hz	0-500 Hz	0-500 Hz
Refrigeración	Forzada	Forzada	Forzada	Forzada

VSD3/A-RFT

Modelo	VSD3/A-RFT-1	VSD3/A-RFT-2	VSD3/A-RFT-3	VSD3/A-RFT-5.5	VSD3/A-RFT-7.5	VSD3/A-RFT-10	VSD3/A-RFT-15	VSD3/A-RFT-20	VSD3/A-RFT-25	VSD3/A-RFT-30
Potencia (CV)	1,00	2,00	3,00	5,50	7,50	10,00	15,00	20,00	25,00	30,00
Potencia (kW)	0,75	1,50	2,20	4,00	5,50	7,50	11,00	15,00	18,50	22,00
Intensidad máxima(A)	2,2	4,1	5,8	9,5	14,0	18,0	24,0	30,0	39,0	46,0
Entrada										
Tipo entrada	Trifásica	Trifásica	Trifásica	Trifásica	Trifásica	Trifásica	Trifásica	Trifásica	Trifásica	Trifásica
Voltage (V)	380-480 V	380-480 V	380-480 V	380-480 V	380-480 V	380-480 V	380-480 V	380-480 V	380-480 V	380-480 V
Frecuencia (Hz)	50-60 Hz	50-60 Hz	50-60 Hz	50-60 Hz	50-60 Hz	50-60 Hz	50-60 Hz	50-60 Hz	50-60 Hz	50-60 Hz
Salida										
Tipo Salida	Trifásica	Trifásica	Trifásica	Trifásica	Trifásica	Trifásica	Trifásica	Trifásica	Trifásica	Trifásica
Voltage (V)	380-480 V	380-480 V	380-480 V	380-480 V	380-480 V	380-480 V	380-480 V	380-480 V	380-480 V	380-480 V
Frecuencia (Hz)	0-500 Hz	0-500 Hz	0-500 Hz	0-500 Hz	0-500 Hz	0-500 Hz	0-500 Hz	0-500 Hz	0-500 Hz	0-500 Hz
Refrigeración	Forzada	Forzada	Forzada	Forzada	Forzada	Forzada	Forzada	Forzada	Forzada	Forzada



Unidades de control y sensores



MTP010

Potenciómetro 10 kΩ para control de velocidad

- Potenciómetro para el control de velocidad de ventiladores equipados con motor brushless o motor asíncrono con VSD.
- Entrega una tensión entre 0 y 10V DC de una forma progresiva.
- Puede usarse como un interruptor.
- Cuerpo resistente a humedad.
- Posibilidad de montaje en superficie o empotrado.



SI-CO2

Detector de calidad de aire

Activa automáticamente el sistema de ventilación cuando el incremento de la contaminación, en función de la ocupación del local, excede del valor prefijado

Modelo	Alimentación	Salida	Consumo (W)	Reglajes	Altura instalación	Temperatura de utilización
SI-CO2-GAQ24	24V ac	0-10V	5	Temporización 10s-30 min	1,5-2,5 m	-20° +50° C



SI-TEMP+HUMEDAD

Opción: Sondas de conducto para temperaturas y humedad opcionales

Sensor de temperatura y humedad relativa con display

Controla independientemente la temperatura y la humedad relativa del aire ambiente del local. Activa automáticamente el sistema de ventilación cuando detecta una temperatura o humedad superior al punto de consigna. Una vez la temperatura o humedad ambiente ha descendido por debajo del punto de consigna, el ventilador permanece en funcionamiento por un tiempo prefijado, regulable mediante reloj interno

Modelo	Alimentación	Salida	Reglajes	Altura instalación	Temperatura de utilización
SI-TEMP+HUMEDAD	24V ac	0-10V dc	$\Delta T = 0,5^{\circ}C$ y $\Delta HR = 2\%$	1,5-2,5 m	+10° +40° C



SI-FUENTE DE ALIMENTACIÓN

Fuente de alimentación 24V dc/ac

Alimenta los sensores inteligentes de 24V dc/ac, a partir de una entrada de tensión de 230V monofásica

Modelo	Alimentación	Salida	Potencia (VA)
SI-FUENTE DE ALIMENTACIÓN dc	230 V	24V dc	30
SI-FUENTE DE ALIMENTACIÓN ac	230/400 V	24/48V ac	25



SI-PIR-TF-Cenital



SI-PIR-TF-Mural

SI-PIR

Detector de presencia

Activa automáticamente el sistema de ventilación cuando detecta la presencia de personas en su radio de acción y se mantiene en funcionamiento por un tiempo prefijado, regulable mediante reloj interno

Modelo	Alimentación	Salida	Ángulo detección	Reglajes	Altura instalación	Temperatura de utilización
SI-PIR	230V	230V	360°C	Temporización 5s-30 min	2,4-4,2 m	-20° +50° C
SI-PIR-TFT-550-B	24V ac/24V dc	24V ac/24V dc	110°C	Temporización 5s-30 min	1,8-3,6 m	-20° +50° C
SI-PIR-TF-25-360	24V ac/24V dc	24V ac/24V dc	360°C	Temporización 10s-30 min	2,4-4,2 m	-20° +50° C

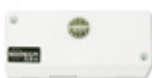

SI-SMOKE

Detector de humo de tabaco

Activa automáticamente el sistema de ventilación cuando el humo de tabaco y otros contaminantes, exceden del valor prefijado en el sensor, y se mantiene en funcionamiento por un tiempo prefijado, regulable mediante reloj interno

Modelo	Alimentación	Salida	Intensidad máx (A)	Reglajes	Altura instalación	Temperatura de utilización
SI-SMOKE	220-240V ac	220-240V ac	3,0	Temporización 3min-20 min	1,5-2,0 m	-20° +50° C



EFFICIENT WORK



SI-TEMP

Sensor de temperatura

Activa automáticamente el sistema de ventilación cuando detecta una temperatura superior al punto de consigna. Una vez la temperatura ambiente ha descendido por debajo del punto de consigna, el ventilador permanece en funcionamiento por un tiempo prefijado, regulable mediante reloj interno. El rango de temperatura oscila entre +10°C a 40°C

Modelo	Alimentación	Salida	Intensidad máx (A)	Reglajes	Altura instalación	Temperatura de utilización
SI-TEMP	220-240V ac	220-240V ac	3,0	Temporización 3min-20 min	1,5-2,0 m	+10° +40° C



SI-PRESIÓN

Transmisor de presión

Controla la presión en instalaciones de ventilación en presión constante, y la transforma en una señal eléctrica, para regular el sistema de ventilación y mantener siempre la misma presión

Modelo	Alimentación	Salida	Consumo máximo (VA)	Ø Conectores	Rango de presión
SI-PRESIÓN TPDA	24V ac/24V dc	0-10V/4-20mA	4	6,2 mm	0-2500 Pa
SI-PRESIÓN TPDA c/DISPLAY	24V ac/24V dc	0-10V/4-20mA	4	6,2 mm	0-2500 Pa



SI-TIMER

Temporizador

Ajusta el tiempo de funcionamiento del sistema de ventilación al cual está conectado. El sistema de ventilación se activa automáticamente con el encendido del interruptor de la luz y continua funcionando por un tiempo prefijado regulable mediante reloj interno

Modelo	Alimentación	Salida	Intensidad máx (A)	Reglajes	Temperatura de utilización
SI-TIMER	220-240V ac	220-240V dc	3,0	Temporización 3min-20 min	-20° +50° C



+



KIT CAUDAL CONSTANTE

Conjunto compuesto de transmisor de presión y convertidor de frecuencia, diseñado para aumentar la velocidad del ventilador a medida que el filtro se ensucia y mantener un caudal constante en la instalación



SI CONTROL PRESIÓN

Control de presión con sonda incorporada

Control de presión con sonda incorporada. Permite controlar un variador o un motor EC, para mantener la presión deseada, haciendo uso de una sonda de presión incorporada en el equipo. El equipo se alimenta a 230 VAC y envía señales de control 0-10V



SI-HUMEDAD

Sensor de humedad relativa

Sensor de humedad relativa para instalación en pared.

Modelo	Alimentación	Salida	rango uso
SI-HUMEDAD	24 V AC	0-10V / 4-20mA	-10°C...50°C



CENTRAL CO

Centrales de detección de monóxido, para el control de la ventilación en aparcamientos

Para cumplir el Real Decreto 2367/1985 y el Código Técnico de la Edificación.

Las centrales de detección de monóxido de carbono, han sido diseñadas para su aplicación en aparcamientos de vehículos subterráneos, túneles u otros lugares donde pueden acumularse concentraciones peligrosas de CO.

El sistema consiste en la instalación de una central de 1 a 3 módulos de zonas con display indicador y cada módulo permite la conexión de hasta 32 detectores conectados con 2 hilos, con una distancia máxima hasta el último detector de 2km.

Los detectores pueden ser distribuidos a lo largo de 2000 metros de longitud y cada detector cubre 200m2 de superficie como máximo, tal y como define la actual normativa

A través de la tarjeta opcional FM-TC500 se puede controlar un regulador de velocidad serie RFM o RFT, con el fin de reducir el consumo energético y el nivel acústico de los extractores.

Estos sistemas tienen como resultado un importante ahorro energético.

- Sistema Certificado según norma UNE 23300/84.
- Certificación LOM 09MOGA3054.
- Central modular y ampliable.
- Hasta 19000 m2 de gestión.
- Versiones de 1, 2, y 3 módulos de zonas.
- Indicación de la concentración por zona.
- 2 salidas de relés de extracción por zona.
- 1 salida de relé de alarma por

- zona.
- Hasta 32 detectores por zona.
- Conexión de los detectores a 2 hilos.
- Modo de funcionamiento para bajo consumo.
- Opción de Control por Variador de Velocidad para reducir consumo energético y nivel acústico.
- Opción de Control remoto del sistema e integración con sistemas de análisis energético.

Modelo	Aplicación
FMC-C-501	Central para 1 zona
FMC-C-502	Central para 2 zona
FMC-C-503	Central para 3 zona
FM-M-509	Módulo ampliación de zona
FM-DP500	Detector de CO de pared
FM-D500	Detector de CO de techo
FM-TC500	Tarjeta control por variador

CENTRALES: Serie FMC-C-501/502/503

- Para 1, 2 o 3 zonas según modelo
- Tensión de Alimentación: 90 ~264VAC
- Potencia: 45 W
- Módulo ampliación de zona FM-M-509
- Conexionado de la zona: 2 hilos
- Distancia máxima de la línea de zona: 2 km. con cable 1,5 mm²
- N° detectores por zona: 32 detectores

Detector CO: Serie FM-DP500/FM-D500

- Detector CO de pared o techo según modelo
- Tecnología: Célula electroquímica
- Vida útil: 5 años
- Resolución: 1 ppm
- Tiempo de reacción: 10 segundos
- Temperatura almacenamiento: -10°C a + 80°C
- Área de trabajo: 200m² limitado por norma
- Índice IP de FM-D500: IP20
- Índice IP de FM-DP500: IP 54

Tarjeta Control por variador. Serie FM-TC500

- Módulo con salidas PWM que permite atacar los motores de extracción mediante reguladores de velocidad (Ahorro energético).
- Módulo de comunicaciones para realizar acciones de tele mantenimiento y tele gestión.
- Protocolo abierto de comunicaciones para integración con otros sistemas.



BOXPRES KIT BOXPRES KIT/B

- El buen funcionamiento de los sistemas de presurización, depende no solo del buen diseño de los mismos, sino también de la buena regulación que realice el sistema, por lo que es de vital importancia contar con elementos de regulación calibrados y de gran precisión, que permitan simultanear las dos situaciones presentes en caso de incendio, de forma rápida y estable.
- El cuadro de control BOXPRES, además de cumplir con las máximas exigencias, simplifica al máximo el trabajo del instalador.
- Incluye:
 - Variador de frecuencia programado a 50 Pa
 - Sonda de presión diferencial
 - Magneto térmico
 - Led de línea y fallo
 - Pulsador de chequeo
- BOXPRES, es un equipo con todas sus conexiones entre sí realizadas y probadas
 - Listo para funcionar y desempeñar su función sobre el control de la presión de la instalación.
 - Posibilidad de chequeo de la instalación para evitar fallos
 - Solo se debe conectar la línea de alimentación, el ventilador de impulsión y la señal de incendio.

Boxpres Kit sobrepresión para motores asíncronos trifásicos.

Modelo	Variador incluido	Potencia kW	Alimentación (V/Hz)	Salida (V/Hz)	Intensidad salida (A)	Tamaño	Medidas (largo x ancho x fondo)
BOXPRES KIT-0,37kW 230Vac	VSD1/A-RFM-0.5	0,37	230 V II / 50Hz	230 V III / 50Hz	2,2	1	270 x 270 x 170 mm
BOXPRES KIT-0,75kW 230Vac	VSD1/A-RFM-1	0,75	230 V II / 50Hz	230 V III / 50Hz	4,3	1	270 x 270 x 170 mm
BOXPRES KIT-1,5kW 230Vac	VSD1/A-RFM-2	1,50	230 V II / 50Hz	230 V III / 50Hz	7,0	1	270 x 270 x 170 mm
BOXPRES KIT-2,2kW 230Vac	VSD1/A-RFM-3	2,20	230 V II / 50Hz	230 V III / 50Hz	10,5	2	360 x 360 x 205 mm
BOXPRES KIT-0,75KW 400Vac	VSD3/A-RFT-1	0,75	400 V III / 50Hz	400 V III / 50Hz	2,2	1	270 x 270 x 170 mm
BOXPRES KIT-1,5KW 400Vac	VSD3/A-RFT-2	1,50	400 V III / 50Hz	400 V III / 50Hz	4,1	1	270 x 270 x 170 mm
BOXPRES KIT-2,2KW 400Vac	VSD3/A-RFT-3	2,20	400 V III / 50Hz	400 V III / 50Hz	5,8	2	360 x 360 x 205 mm

Boxpres Kit sobrepresión para motores Brushless Industrial E.C.

Modelo	Variador incluido	Potencia kW	Alimentación (V/Hz)	Salida (V/Hz)	Intensidad salida (A)	Tamaño	Medidas (largo x ancho x fondo)
BOXPRES KIT/B-0,37kW 230Vac	VSD1/B-0.37	230 V II / 50Hz	230 V III / 50Hz	2,2	1	270 x 270 x 170 mm	
BOXPRES KIT/B-0,75kW 230Vac	VSD1/B-0.75	230 V II / 50Hz	230 V III / 50Hz	4,3	1	270 x 270 x 170 mm	
BOXPRES KIT/B-1,5kW 230Vac	VSD1/B-1.5	230 V II / 50Hz	230 V III / 50Hz	7,0	1	270 x 270 x 170 mm	
BOXPRES KIT/B-2,2kW 230Vac	VSD1/B-2.2	230 V II / 50Hz	230 V III / 50Hz	10,5	2	360 x 360 x 205 mm	
BOXPRES KIT/B-0,75KW 400Vac	VSD3/B-0.75	400 V III / 50Hz	400 V III / 50Hz	2,2	1	270 x 270 x 170 mm	
BOXPRES KIT/B-1,5KW 400Vac	VSD3/B-1.5	400 V III / 50Hz	400 V III / 50Hz	4,1	1	270 x 270 x 170 mm	
BOXPRES KIT/B-2,2KW 400Vac	VSD3/B-2.2	400 V III / 50Hz	400 V III / 50Hz	5,8	2	360 x 360 x 205 mm	

**Prensaestopas de entrada cable a equipo
Tamaño 1**

- M 20 x 1,5mm
Conexión Alimentación y motor
- M 12 x 1,5mm
Conexión Señal Incendio
- Conexión de presión

**Prensaestopas de entrada cable a equipo
Tamaño 2**

- M 20 x 1,5mm
Conexión Alimentación y motor
- M 12 x 1,5mm
Conexión Señal Incendio
- Conexión de presión





EFFICIENT WORK



Reguladores electrónicos de velocidad



Para extractores monofásicos, posibilidad de montaje en superficie o empotrados

Modelo	Tensión entrada	Protección	Int. Máx(A)
RM-00	230 V-50/60 Hz	IP-44	0,5
RM-01	230 V-50/60 Hz	IP-44	1
RM-02	230 V-50/60 Hz	IP-44	2

DUO



Interruptor cambio de velocidad y paro, para pequeños ventiladores con motor de 2 velocidades

Modelo	Tensión entrada	Int. Máx(A)
DUO	230 V-50/60 Hz	16

Control velocidad motor brushless



Modelo	Tensión de salida	Valor resistivo
MTP	0-10VDC	10KΩ

Bocas de captación



De material plástico para embocar en conducto

Modelo	Medidas ext.	Conducto
BC-135x235	135x235mm	100mm
BC-140x340	140x340mm	100mm
BC-240x240	240x240mm	150mm

Bocas de salida



De material plástico para instalar en el exterior

Modelo	Medidas exteriores
SA-140x140	140x140mm
SA-240x240	240x240mm

Bocas de aspiración/impulsión



De material plástico con difusor

Modelo	Para conducto	Color
BA-100/B	100mm	Blanco
BI-100/B	100mm	Blanco

Kits de entrada y salida



Compuesto de 2 rejillas y tubo flexible

Modelo	Conducto	Paso de aire
KIT-120	120mm	100cm ²
KIT-160	160mm	100cm ²
KIT-200	200mm	100cm ²

Rejillas rectangulares



De material plástico para adaptar en agujero rectangular

Modelo	Medidas Ext.	Para agujero de
R-140 x 140	140 x 140 mm	102 x 102 mm
R-189 x 189	189 x 189 mm	150 x 150 mm
R-240 x 140	240 x 140 mm	202 x 102 mm
R-340 x 140	340 x 140 mm	308 x 108 mm

Rejillas circulares



De material plástico con sistema universal de muelle para adaptar en agujero circular

Modelo	Medidas ext.	Para agujero de
RC-100/B	106 mm	40 a 80 mm
RC-125/B	155 mm	80 a 125 mm
RC-150/B	175 mm	125 a 160 mm
RC-200/B	235 mm	165 a 220 mm
RC-250/B	270 mm	220 a 260 mm

Rejillas de protección serie NEOLINEO



Previene contra contactos con la turbina y posibles entradas de objetos

Modelo	Aplicable a los modelos	Modelo	Aplicable a los modelos
G 100	NEOLINEO-100	G 200	NEOLINEO-200
G 125	NEOLINEO-125	G 250	NEOLINEO-250
G 150	NEOLINEO-150	G 315	NEOLINEO-315
G 160	NEOLINEO-160		

Persianas de sobrepresión



De material plástico que se adapta directamente sobre la pared en que se instala el ventilador

Modelo	Medidas exteriores
PL-140x140	140x140mm
PL-180x180	180x180mm
PL-240x240	240x240mm
PL-340x340	340x340mm
PL-440x440	440x440mm

Rejillas de protección serie SV



Previene contra contactos con la turbina y posibles entradas de objetos

Modelo	Aplicable a los modelos
RAI-125	SV-125
RAI-150	SV-150
RAI-200	SV-200
RAI-250	SV-250
RAI-315	SV-315
RAI-350	SV-350
RAI-400	SV-400

Base de instalación en serie



Placa de adaptación entre dos ventiladores de la serie NEOLINEO

Modelo	Aplicable a los modelos
SF 500	NEOLINEO-100,125,150,160,200
SF 700	NEOLINEO-250,315

Kit de instalación en paralelo



Conjunto de piezas para la instalación en paralelo de dos ventiladores de la serie NEOLINEO

Modelo	Aplicable a los modelos	Modelo	Aplicable a los modelos
PF100	NEOLINEO-100	PF160	NEOLINEO-160
PF125	NEOLINEO-125	PF200	NEOLINEO-200
PF150	NEOLINEO-150	PF250	NEOLINEO-250

Conducto de instalación en serie



Conducto de unión entre dos ventiladores de la serie NEOLINEO

Modelo	Aplicable a los modelos	Modelo	Aplicable a los modelos
C100	NEOLINEO-100	C200	NEOLINEO-200
C125	NEOLINEO-125	C250	NEOLINEO-250
C150	NEOLINEO-150	C315	NEOLINEO-315
C160	NEOLINEO-160		

Accesorios



De fácil instalación, para realizar montajes en sistemas de aspiración localizada

Modelo	Características
TUB-100	Conducto de diámetro 100 mm y longitud 1 m
UN-100	Unión entre conducto y accesorios
COD-100	Codo 90° diámetro 100 mm
BRIDA-100	Bridas de sujeción del conducto
REDU-100-125	Reducción de tubería a diferentes diámetros
TUB-125	Conducto de diámetro 125 mm y longitud 1 m
UN-125	Unión entre conducto y accesorios
COD-125	Codo 90° diámetro 125 mm
BRIDA-125	Bridas de sujeción del conducto
REDU-125-100	Reducción de tubería a diferentes diámetros

Cajas de filtro de aire



Cajas de filtro rectangulares, para conductos circulares, equipados con filtros G3 -G4

Modelo	Caja de filtros G3-G4 para conductos de
AIRFILTER-100-G3/G4	100mm
AIRFILTER-125-G3/G4	125mm
AIRFILTER-160-G3/G4	160mm
AIRFILTER-200-G3/G4	200mm
AIRFILTER-250-G3/G4	250mm
AIRFILTER-315-G3/G4	315mm
AIRFILTER-355-G3/G4	355mm
AIRFILTER-400-G3/G4	400mm

Baterías eléctricas



Se adapta a la boca de impulsión

Modelo	Batería eléctrica para conducto de
BE-100	100 mm de 0,4 kW 230 V
BE-125	125 mm de 1,2 kW 230 V
BE-160	160 mm de 2,4 kW 230 V
BE-200	200 mm de 5 kW 400 V
BE-250	250 mm de 6 kW 400 V
BE-315	315 mm de 7,5 kW 400 V
BE-355	355 mm de 9 kW 400 V
BE-400	400 mm de 9 kW 400 V

Compuertas antiretorno



Para intercalar en conductos circulares

Modelo	Aplicable a los modelos	Modelo	Aplicable a los modelos
S 100	NEOLINEO-100	S 200	NEOLINEO-200
S 125	NEOLINEO-125	S 250	NEOLINEO-250
S 150	NEOLINEO-150	S 315	NEOLINEO-315
S 160	NEOLINEO-160		

Válvulas de mariposa



Para intercalar en conductos circulares

Modelo	Válvula de mariposa para	Modelo	Válvula de mariposa para
V-100	100mm	V-250	250mm
V-125	125mm	V-315	315mm
V-160	160mm	V-355	355mm
V-200	200mm	V-400	400mm

STUB



Soporte ventilador

Modelo	Aplicable a los modelos
STUB-200	TUB
STUB-225	TUB
STUB-250	TUB

ARE

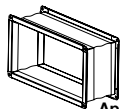

Acoplamiento rectangular elástico

Modelo	Aplicable a los modelos	Modelo	Aplicable a los modelos
ARE-200	CL-200	ARE-315	CL-315
ARE-225	CL-225	ARE-355	CL-355
ARE-250	CL-250	ARE-400	CL-400
ARE-280	CL-280	ARE-450	CL-450

RR

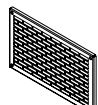

Rejilla de protección para la aspiración o impulsión

Modelo	Aplicable a los modelos	Modelo	Aplicable a los modelos
RR-200	CL-200	RR-315	CL-315
RR-225	CL-225	RR-355	CL-355
RR-250	CL-250	RR-400	CL-400
RR-280	CL-280	RR-450	CL-450

CJFILTER/CL

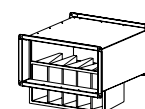

Cajas de filtro de aire rectangulares

Modelo	Aplicable a los modelos	Modelo	Aplicable a los modelos
CJFILTER/CL-200	CL-200	CJFILTER/CL-315	CL-315
CJFILTER/CL-225	CL-225	CJFILTER/CL-355	CL-355
CJFILTER/CL-250	CL-250	CJFILTER/CL-400	CL-400
CJFILTER/CL-280	CL-280	CJFILTER/CL-450	CL-450

SR



Silenciadores rectangulares

Modelo	Aplicable a los modelos	Modelo	Aplicable a los modelos
SR-200	CL-200	SR-315	CL-315
SR-225	CL-225	SR-355	CL-355
SR-250	CL-250	SR-400	CL-400
SR-280	CL-280	SR-450	CL-450

TAC/CL

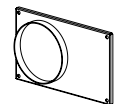

Tapa de acoplamiento circular

Modelo	Aplicable a los modelos	Modelo	Aplicable a los modelos
TAC/CL-200	CL-200	TAC/CL-315	CL-315
TAC/CL-225	CL-225	TAC/CL-355	CL-355
TAC/CL-250	CL-250	TAC/CL-400	CL-400
TAC/CL-280	CL-280	TAC/CL-450	CL-450

PSA

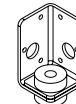

Pie soporte techo

Modelo	Aplicable a los modelos
PSA-200	CL-200, CL-225, CL-250, CL-280, CL-315, CL-355, CL-400, CL-450

SC



Silenciadores para acoplar a la aspiración o a la impulsión

Características:

- Silenciadores circulares para acoplar a la aspiración o impulsión de extractores en línea.
- Silenciadores equipados con cuello para acople de conductos circulares.



Modelo	Ød1	ød2	L	M	Atenuación acústica							
					63	125	250	500	1000	2000	4000	8000
S-125	125	225	600	720	1,1	2,9	8,8	19,4	27,2	34,1	27,2	13,4
S-160	160	260	600	720	1	2,9	7,2	16,5	23,4	29,6	20,3	9,2
S-200	200	300	600	720	0,95	2,9	7	14,6	20,3	25,8	15,6	6,8
S-250	250	355	600	720	0,22	2,1	7,2	12,5	18,8	23	10,3	5,15
S-315	315	415	600	720	0,2	2,1	7,2	10,3	15	20	7	3,9
S-355	355	450	700	820	3,6	4,2	6,5	13,2	14,2	4	7,9	7,2



EFFICIENT WORK



INT Interruptores de seguridad paro-marcha para cumplir la Norma UNE-EN 60204-1

Características:

- Interruptores para instalar al lado del ventilador y de esta forma poder cortar la corriente antes de manipular el ventilador
- Protección IP65
- Ventiladores trifásicos o de 2 velocidades, utilizar interruptor de 6 polos
- Ventiladores monofásicos, utilizar interruptor de 3 polos

Modelo	Intensidad (A)	Intensidad (Kw)	Entrada cables (mm)	Modelo	Intensidad (A)	Intensidad (Kw)	Entrada cables (mm)
INT-CA 10/3CA	20	5,5	19	INT-CA 10/6CA	20	5,5	19
INT-KG 10/3CA	20	5,5	23	INT-KG 10/6CA	20	5,5	23
INT-KG 20/3CA	25	7,5	29	INT-KG 20/6CA	25	7,5	29
INT-KG 32/3CA	32	11	29	INT-KG 32/6CA	32	11	29
INT-KG 41/3CA	40	15	37,5	INT-KG 41/6CA	40	15	37,5
INT-KG 64/3CA	63	22	37,5	INT-KG 64/6CA	63	22	37,5
INT-KG 80/3CA	80	30	37,5	INT-KG 80/6CA	80	30	37,5
INT-KG 100/3CA	100	37	37,5	INT-KG 100/6CA	100	37	37,5



AET

Cuadro eléctrico de arranque estrella / triángulo y protección de ventiladores trifásicos, con pulsadores de paro y marcha

Características:

- Paro y marcha mediante pulsador
- Visualización de estado mediante pilotos luminosos
- Incorpora relé térmico regulable para protección del motor
- Totalmente cableado
- Caja metálica para montaje en superficie, protección IP-65

Para ventilador con motor trifásico 230V/400V Alimentación 3x230V			Para ventilador con motor trifásico 400V/690V Alimentación 3x400V+N		
Modelo	Intensidad regulación relé térmico (A)	Potencia motor 3x230/400V (kW)	Modelo	Intensidad regulación relé térmico (A)	Potencia motor 3x400/690V (kW)
AET-01-3/230	4-6,3	2,2	AET-01-5,5/400	4-6,3	4
AET-01-4/230	5-8	3,0	AET-01-7,5/400	5-8	5,5
AET-01-5,5/230	7-10	4,0	AET-01-10/400	7-10	7,5
AET-01-7,5/230	12-18	5,5	AET-01-15/400	12-18	11
AET-01-10/230	12-18	7,5	AET-01-20/400	12-18	15
AET-01-15/230	18-26	11,0	AET-02-30/400	18-26	18,5/22,0
AET-01-20/230	24-36	15,0	AET-02-40/400	28-40	30
AET-01-25/230	28-40	18,5	AET-02-50/400	34-50	37
AET-02-30/230	34-50	22,0	AET-02-60/400	45-65	45
AET-02-40/230	45-65	30,0	AET-02-75/400	45-65	55
AET-02-50/230	63-85	37,0			



PL Persianas de sobrepresión en material plástico

Características:

- La persiana de sobrepresión se adapta directamente sobre la pared en que se instala el ventilador
- Apertura mediante sobrepresión por el flujo de aire
- Se cierran cuando el ventilador está en reposo
- Construcción en material plástico
- Velocidad máxima recomendable de 12m/seg. para los modelos 80,90 y 100

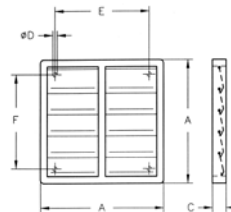

Modelo	Dimensiones				
	A	C	ØD	E	F
PL-20	240	28	5,2	193	167
PL-25	294	26	5	232	232
PL-31	347	26	5	276	276
PL-35	397	26	5	310	310
PL-40	459	26	5	364	364
PL-45	501	26	5	395	395
PL-50	549	31	5	445	445
PL-56	605	28	5	522	522
PL-63	696	31	5	626	626
PL-71	760	40	5	692	692
PL-80	840	40	5	772	772
PL-90	940	40	5	872	87
PL-100	1040	40	5	972	972



P Persianas de sobrepresión en aluminio

Características:

- La persiana de sobrepresión se adapta directamente sobre la pared en que se instala el ventilador
- Apertura mediante sobrepresión por el flujo de aire
- Se cierran cuando el ventilador está en reposo
- Construcción en chapa de aluminio
- Velocidad máxima recomendable de 18m/seg. para los modelos 90 y 100

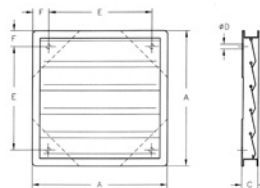

Modelo	Dimensiones				
	A	C	ØD	E	F
P-25	290	51	6	187	51,5
P-35	400	81	6	266	67
P-45	500	51	6	347	76,5
P-56	600	51	6	447	76,5
P-63	715	72	6	535	90
P-71	780	72	6	605	87,5
P-80	875	72	6	675	100
P-90	970	72	6	755	107,5
P-100	1070	72	6	850	110



R Rejilla de protección para la aspiración de ventiladores helicoidales

Modelo	HC	HCH
R-35/B	-	35
R-40	-	40
R-45	-	45
R-56	-	56-4T/M-0,75, 56-4T-1, 56-6T/M-0,33, 56-6T-0,5, 56-6T-0,75
R-56 - 1,5	-	56-4T-1,5, 56-4T-2
R-63 - 0,5	-	63-4T-1, 63-6T/M-0,5, 63-6T-0,75
R-63 - 1,5	-	63-4T-1,5, 63-4T-2, 63-6T-1
R-63 - 4	-	63-4T-3, 63-4T-4
R-71	-	71-4T-1,5, 71-4T-2, 71-6T/M-0,75, 71-6T-1, 71-6T-1,5
R-71/C	71	
R-71-3	-	71-4T-3, 71-4T-4
R-80	-	80-6T-1, 80-6T-1,5, 80-8T-0,5, 80-8T-0,75

Modelo	HC	HCH
R-80/C	80	
R-80 - 5,5	-	80-4T-3, 80-4T-4, 80-4T-5,5, 80-6T-2, 80-6T-3, 80-8T-1
R-90	-	90-4T-4, 90-4T-5,5, 90-6T-2, 90-6T-3, 90-8T-1, 90-8T-1,5, 90-8T-2
R-90/C	90	
R-90 - 7,5	-	90-4T-7,5, 90-4T-10, 90-6T-4, 90-8T-3
R-100	-	100-6T-3, 100-8T-1,5, 100-8T-2
R-100/C	100	
R-100-7,5/C	100 4T/H	
R-100 - 10	-	100-4T-7,5, 100-4T-10, 100-6T-4, 100-6T-5,5, 100-8T-1,5, 100-8T-2
R-100 - 20	-	100-4T-15, 100-4T-20



RI

Rejilla de protección para la impulsión de ventiladores helicoidales.

Modelo	HEP	HCD	HC	HRE	HCH
RI-20	-	20	-	-	-
RI-25/E	-	-	-	25	-
RI-25	25	25	25	-	-
RI-31/E	-	-	-	31	-
RI-31	31	30	31	-	-
RI-35/E	-	-	-	35	-
RI-35/B	-	-	-	-	35
RI-35/C	35	35	35	-	-
RI-40	40	40	40	-	40

Modelo	HEP	HCD	HC	HRE	HCH
RI-45	45	-	45	-	45
RI-50	50	-	50	-	-
RI-56	56	-	56	-	56
RI-63	63	-	63	-	63
RI-71	-	-	71	-	71
RI-80	-	-	80	-	80
RI-90	-	-	90	-	90
RI-100	-	-	100	-	100

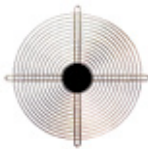

RT

Rejilla de protección para la aspiración o impulsión de ventiladores helicoidales tubulares.

Modelo	HEPT	HCT	HGT	HPX
RT-25	-	25	-	-
RT-31/B	-	31	-	-
RT-31	31	-	-	-
RT-35	35	35	-	35
RT-40	40	40	-	-

Modelo	HEPT	HCT	HGT	HPX
RT-45	45	45	-	45
RT-50	50	50	-	50
RT-56	56	56	-	56
RT-63	63	63	-	63
RT-71	-	71	-	71

Modelo	HEPT	HCT	HGT	HPX
RT-80	-	80	-	80
RT-90	-	90	-	90
RT-100	-	100	-	100
RT-125	-	-	125	-
RT-125/CC	-	-	125	-



RPA

Rejilla de protección para la aspiración de ventiladores centrífugos

Características:

- Previene contra contactos con la turbina y posibles entradas de objetos, según norma UNE-100250
- Construida en chapa de acero

Aplicable a los modelos

Modelo	CMA CMAT	CMC	CB	CBP	CAS	CA	CAM	CMP	CMT	CMR-X CMR
RPA-10	-	-	-	-	-	-	-	38	-	-
RPA-11	218	-	-	-	-	-	-	-	-	-
RPA-13	324	-	-	-	-	234	-	-	-	-
RPA-15	325/426	-	-	-	242	142	-	512	-	-
RPA-17	527	-	-	-	248	148	-	514	-	-
RPA-18	528	-	-	-	254	154	-	-	-	-
RPA-20	531	-	-	-	260	-	-	616	-	-
RPA-23	-	628/630	-	-	680/160/166/172	540/545	-	718	922	-
RPA-25	540/545	835/840	820	-	790	-	-	620/820	1025	-
RPA-28	-	-	-	-	463/467	-	550/752	922	1128	-
RPA-31	-	-	1428	-	-571/640/645/650/980/1080-	-	760	1025	1231	-
RPA-35	-	-	-	-	-852/990/1090	-	-	1128	1435/1640	-
RPA-38	-	-	1733	-	-	-	880	1231	-	1031
RPA-42	-	-	-	-	856	-	-	1435	1845	1135
RPA-44	-	-	-	-	1250/A	-	-	-	-	-
RPA-47	-	-	2240	-	863/971	-	-	1640	2050	1240
RPA-48	-	-	-	-	1456/A	-	-	-	-	-
RPA-52	-	-	-	1445	-	-	-	1845	-	1445
RPA-55	-	-	-	-	-	-	-	-	-	-
RPA-60	-	-	-	1650	-	-	-	2050	-	1650
RPA-65	-	-	-	-	1663/A	-	-	-	-	-
RPA-66	-	-	-	1856	-	-	-	-	-	1856
RPA-73	-	-	-	-	-1671/A-2071/A	-	-	2563	-	2063
RPA-81	-	-	-	-	2080/A	-	-	-	-	2271
RPA-88	-	-	-	-	-	-	-	-	-	2380
RPA-90	-	-	-	-	-	-	-	-	-	2590
RPA-100	-	-	-	-	-	-	-	-	-	28100



PV

Pabellón de aspiración aplicable a las series HEPT, HCT, HGT, HTP

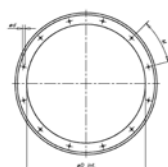

Modelo	øA	øB	øD	ød	E	M	H
PV-315	398	355	320	10	1,5	8x45°	165
PV-355	438	395	359	10	1,5	8x45°	165
PV-400	484	450	401	12	1,5	8x45°	165
PV-450	534	500	450	12	1,5	8x45°	165
PV-500	584	560	504	12	1,5	12x30°	165
PV-560	664	620	565	12	1,5	12x30°	165
PV-630	734	690	634	12	1,5	12x30°	165
PV-710	812	770	711	12	2	16x22,5°	250

Modelo	øA	øB	øD	ød	E	M	H
PV-800	904	860	797	12	2	16x22,5°	250
PV-900	1004	970	894	14	2	16x22,5°	250
PV-1000	1105	1070	1003	14	2	16x22,5°	250
PV-1250	1370	1320	1240	14	2	20x18°	250
PV-1400	1533	1470	1413	15	3	20x18°	250
PV-1600	1705	1680	1585	19	3	24x15°	315
PV-1800	1908	1830	1788	19	3	24x15°	315
PV-2000	2113	2080	1993	19	3	24x15°	315



EFFICIENT WORK



BTUB

Brida de acoplamiento para ventiladores helicoidales

Modelo	HEPT	HCT	HGT	HPX	HT*
BTUB-250	-	25	-	-	25
BTUB-280	-	31	-	-	-
BTUB-315	31	-	-	-	31
BTUB-355	35	35	-	-	35
BTUB-400	40	40	-	-	40
BTUB-450	45	45	-	45	45

Modelo	HEPT	HCT	HGT	HPX	HT*
BTUB-500	50	50	-	50	50
BTUB-560	56	56	-	56	56
BTUB-630	63	63	-	63	63
BTUB-710	-	71	-	71	71
BTUB-800	-	80	-	80	80
BTUB-900	-	90	-	90	90

Modelo	HEPT	HCT	HGT	HPX	HT*
BTUB-1000	-	100	-	100	100
BTUB-1250	-	-	125	-	-
BTUB-1400	-	-	140	-	-
BTUB-1600	-	-	160	-	-

* Para la instalación es necesario utilizar accesorio PA



B Brida de acoplamiento para ventiladores centrífugos

Características:

- Se adapta a la boca de aspiración y de impulsión
- Facilita la instalación al conducto

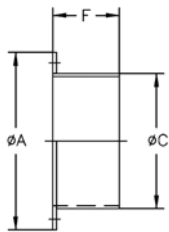

	A	C	F
B-52-E	100	52	67
B-63	110	63	60
B-80	150	80	60
B-80-E	150	80	60
B-100	150	100	60
B-100-E	170	100	60
B-112	160	112	60
B-125	180	125	60
B-140	190	140	60
B-150	210	150	60
B-160	220	160	60
B-160/1	220	160	60
B-180	240	180	60
B-200	260	200	60

	A	C	F
B-224	280	224	60
B-250/1	310	250	80
B-250/2	310	250	80
B-250/3	310	250	80
B-250/4	310	250	80
B-250/5	310	250	80
B-280/1	350	280	80
B-280/2	350	280	80
B-280/3	350	280	80
B-315/1	350	315	80
B-315/2	380	315	80
B-315/3	380	315	80
B-315/4	380	315	80
B-355/1	430	355	80

	A	C	F
B-355/2	430	355	80
B-355/3	430	355	80
B-355/4	430	355	80
B-400/1	480	400	80
B-400/2	480	400	80
B-400/3	480	400	80
B-400/4	480	400	80
B-450/1	530	450	80
B-450/2	530	450	80
B-450/3	530	450	80
B-500/1	590	500	80
B-500/2	590	500	80
B-500/3	590	500	80
B-500/4	590	500	80

	A	C	F
B-500/5	590	500	80
B-560/1	650	560	80
B-560/2	650	560	80
B-560/3	650	560	80
B-630/1	720	630	80
B-630/2	720	630	80
B-630/3	720	630	80
B-630/4	720	630	80
B-710/1	800	710	80
B-710/2	800	710	80
B-710/3	800	710	80
B-800	890	800	100
B-900/1	1000	900	100
B-1000/1	1100	1000	100

Modelo	CHT/CVT	CHRE
B-52-E	-	-
B-63	-	-
B-80	-	-
B-80-E	-	-
B-100	-	-
B-100-E	-	-
B-112	-	-
B-125	-	-
B-140	-	-
B-150	-	-
B-160	-	-

Modelo	CHT/CVT	CHRE
B-160/1	-	722
B-180	-	825
B-200	-	-
B-224	-	-
B-250/1	-	-
B-250/2	-	-
B-250/3	200/225	1131
B-250/4	-	-
B-250/5	-	-
B-280/1	-	-
B-280/2	-	-

Modelo	CHT/CVT	CHRE
B-280/3	-	-
B-315/1	-	-
B-315/2	-	-
B-315/3	-	-
B-315/4	-	-
B-355/1	-	-
B-355/2	-	-
B-355/3	250/315	1135/1240
B-355/4	-	-
B-400/1	-	-
B-400/2	-	-

Modelo	CHT/CVT	CHRE
B-400/3	-	-
B-400/4	-	-
B-450/1	-	-
B-450/2	-	-
B-450/3	-	-
B-500/1	-	-
B-500/2	-	-
B-500/3	-	-
B-500/4	400/450	1445/1650
B-560/1	-	-
B-560/2	-	-

Modelo	CHT/CVT	CHRE
B-560/3	-	-
B-630/1	-	-
B-630/2	-	-
B-630/3	500	-
B-630/4	-	-
B-710/1	-	-
B-710/2	560/630	-
B-710/3	-	-
B-800	-	-
B-900/1	-	-
B-1000/1	-	-



BD Brida de acoplamiento doble para ventiladores centrífugos

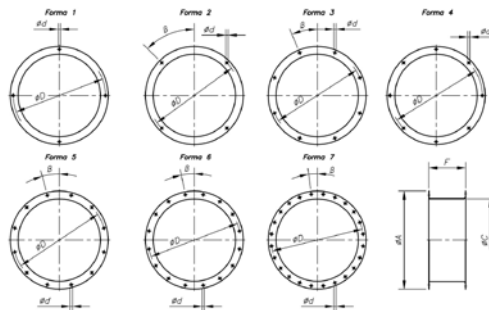

Características:

- Se adapta a la boca de aspiración
- Facilita la instalación al conducto con brida

	ØA	ØC	ØD	Ød	F	β	Forma
BD-200	260	200	225	7	80	15°	2
BD-224	280	224	254	7	80	-	1
BD-250/1	310	250	280	10	80	45°	2
BD-280	350	280	320	10	100	-	4
BD-315/3	390	315	355	10	100	22°30'	3
BD-355/3	430	355	395	10	100	22°30'	3
BD-400/1	480	400	450	12	100	22°30'	3
BD-400/2	480	400	450	12	100	22°30'	3
BD-450/1	530	450	500	12	100	22°30'	3
BD-450/2	530	450	500	12	100	22°30'	3
BD-500/2	590	500	560	12	100	15°	5
BD-560	650	560	620	12	120	15°	5
BD-630/2	720	630	690	12	120	15°	5
BD-710	800	710	770	12	120	11°15'	6
BD-800	890	800	860	12	140	11°15'	6
BD-900/1	1000	900	958	12	140	11°15'	6
BD-1000/1	1100	1000	1067	14	140	7°30'	7

Modelo	Aplicable a los modelos			
	CB	CMP	CMR-X CMR	CMC
BD-112	-	512	-	-
BD-140	-	514	-	-
BD-160	-	616	-	628/630
BD-180	-	718	-	-
BD-200	820	620/820	-	835/840
BD-224	-	922	-	-
BD-250/1	-	1025	-	-
BD-250/2	1428	-	-	-
BD-280	-	1128	-	-
BD-315/1	1733	-	-	-

Modelo	Aplicable a los modelos			
	CB	CMP	CMR-X CMR	CMC
BD-315/2	-	-	1031	-
BD-315/3	-	1231	-	-
BD-355/1	-	-	1135	-
BD-355/2	2240	-	-	-
BD-355/3	-	1435	-	-
BD-400/1	-	1640	-	-
BD-400/2	-	-	1240	-
BD-450/1	-	1845	-	-
BD-450/2	-	-	1445	-
BD-500/1	-	2050	-	-

Modelo	Aplicable a los modelos			
	CB	CMP	CMR-X CMR	CMC
BD-500/2	-	-	1650	-
BD-560	-	-	1856	-
BD-630/1	-	2563	-	-
BD-630/2	-	-	2063	-
BD-710	-	-	2271	-
BD-800	-	-	2380	-
BD-900/1	-	-	2590	-
BD-1000/1	-	-	28100	-



BAC

Brida de acoplamiento doble y elástica para ventiladores helicoidales

Características:

- Se adapta a la boca de aspiración e impulsión
- Facilita la instalación al conducto con brida
- Evita la transmisión de vibraciones

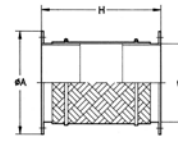

	ØD*	ØA*	H
BAC-250	250	310	340
BAC-355	355	430	340
BAC-400	400	480	340
BAC-450	450	530	340
BAC-500	500	590	340
BAC-560	560	650	340
BAC-630	630	720	340
BAC-710	710	800	340
BAC-800	800	890	340
BAC-900	900	1000	340
BAC-1000	1000	1100	340
BAC-1250	1250	1365	340

*Diámetro nominal tubería

Modelo	HEPT	HCT	HGT	CHT	HT	HPX	CHRE
BAC-160	-	-	-	-	-	-	722
BAC-180	-	-	-	-	-	-	825
BAC-250	-	25	-200/225	25	-	-	1131
BAC-315/B	-	31	-	-	-	-	-
BAC-315	31	-	-	-	31	-	-
BAC-355	35	35	-250/315	35	-	351135/1240	-
BAC-400	40	40	-	-	40	-	-
BAC-450	45	45	-	-	45	45	-

Modelo	HEPT	HCT	HGT	CHT	HT	HPX	CHRE
BAC-500	50	50	-400/450	50	-	50 1145/1650	-
BAC-560	56	56	-	-	56	56	-
BAC-630	63	63	-	500	63	63	-
BAC-710	-	71	-560/630	71	71	-	-
BAC-800	-	80	-	-	80	80	-
BAC-900	-	90	-	-	90	90	-
BAC-1000	-	100	-	-	100	100	-
BAC-1250	-	-	125	-	-	-	-



PS

Conjunto de pies soporte, para ventiladores tubulares.

Características:

- Al fijarse a la brida facilita la fijación sobre superficies planas

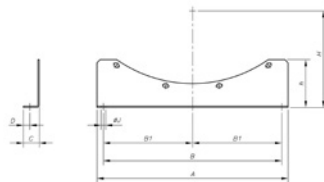

	A	B	B1	C	D	h	H	ØJ	HEPT	HCT	HGT	HPX
PS-25/31	275	225	-	25	10,5	90	165	10	-	25	-	-
	275	225	-	25	10,5	90	191,5	10	-	31	-	-
	275	225	-	25	10,5	90	205	10	31	-	-	-
PS-35/40	240	200	-	30	13	60	230	10	35	35	-	35
	240	200	-	30	13	60	255,5	10	40	40	-	-
PS-45/50	450	400	200	35	14,5	125	278	12	45	45	-	45
	450	400	200	35	14,5	125	305	12	50	50	-	50
PS-56/63	520	430	215	40	17	155	338	13	56	56	-	56
	520	430	215	40	17	155	385,5	13	63	63	-	63
PS-71	490	450	225	50	21	150	445	13	-	71	-	71
PS-80	600	560	280	50	21	150	490	13	-	80	-	80
PS-90	620	560	280	60	28	175	547,5	18	-	90	-	90
PS-100	680	560	280	60	28	185	597,5	18	-	100	-	100
PS-125	1000	900	300	60	28	285	726,5	18	-	-	125	-



PSB

Conjunto de pies soporte, para ventiladores centrífugos de baja presión

Características:

- Conjunto de 2 piezas, que facilita la fijación sobre superficies planas

Modelo	Aplicable a los modelos
PSB-1428	CB-1428
PSB-1733	CB-1733
PSB-19	CBD-1919, CBX-1919

Modelo	Aplicable a los modelos
PSB-25	CBD-2520, CBD-2525, CBX-2525
PSB-28	CBD-2821, CBD-2828, CBX-2828
PSB-33	CBD-3325, CBD-3333, CBX-3333

Modelo	Aplicable a los modelos
PSB-39	CBD-3939, CBX-3939
PSB-47	CBX-4747



MS

Marco soporte para facilitar el montaje en obra

Características:

- Utilizado para facilitar el montaje del ventilador en conductos de obra

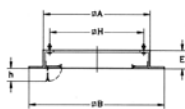

	ØA	ØB	E	ØH	h
MS-348	348	520	60	295	70
MS-393	393	565	60	320	70
MS-443	443	615	60	360	70
MS-493	493	665	60	410	70
MS-553	553	725	60	450	70

	ØA	ØB	E	ØH	h
MS-623	623	795	60	530	70
MS-701	701	875	60	590	90
MS-791	791	965	60	680	90
MS-891	891	1065	60	750	90
MS-991	991	1165	60	850	90
MS-1086	1086	1260	60	900	90
MS-1140	1140	1314	60	1000	90
MS-1240	1240	1414	60	1100	90

Modelo	CHT	HT	CHRE
MS-348	-	-	722
MS-393	-	-	825
MS-443	200/225	25	1131
MS-493	-	31	-
MS-553	250/315	35	1135/1240
MS-623	-	40	-
MS-701	400/450	45	1445/1650
MS-791	-	50	-
MS-891	500	56	-
MS-991	-	63/71	-
MS-1086	560/630	-	-
MS-1140	-	80/90	-
MS-1240	-	100	-



TEJ

Tejadillos para intemperie

Características:

- Evita la entrada de agua, en unidades de ventilación instaladas en el exterior

Aplicable a los modelos

	A	B	E	CJMP	CJTCH/R	CJS
TEJ-820	500	550	26	820	-	-
TEJ-922	710	710	26	922	-	-
TEJ-1025	760	760	26	1025	-	-
TEJ-1128	820	820	26	1128	-	-
TEJ-1231	900	900	26	1231	-	1240/1850
TEJ-1435	980	980	26	1435	-	-

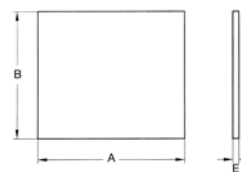

Aplicable a los modelos

	A	B	E	CJMP	CJTCH/R	CJS
TEJ-1640	1071	1070	26	1640	1240	2056/2263-6T
TEJ-1845	1170	1170	26	1845	1445	2263-4T/2071/2280
TEJ-1856	1360	1150	26	-	1856	-
TEJ-2050	1260	1260	26	2050	1650	-
TEJ-2063	1500	1300	26	-	2063	-
TEJ-2271	1655	1455	26	-	2271	-



EFFICIENT WORK

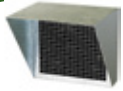

VIS Viseras de impulsión con rejilla de protección.

Características:

- Evita la entrada de objetos y agua al interior del ventilador

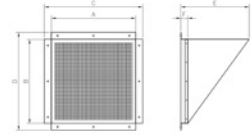

	A	B	C	D	E	F	CJTX-C	
VIS-7/7	269	246	309	286	200	50	7/7	
VIS-9/9	335	300	375	340	200	50	9/9	
VIS-10/10	364	326	404	366	250	50	10/10	
VIS-12/12	425	380	465	420	250	50	12/12	
VIS-15/15	513	441	573	501	300	50	15/15	
VIS-18/18	582	510	642	570	350	50	18/18	
VIS-20/20	641	641	741	741	400	50	20/20	
VIS-22/22	695	735	795	835	450	50	22/22	
VIS-25/25	805	836	905	936	500	50	25/25	
VIS-30/28	930	972	1030	1072	600	50	30/28	
	A	B	C	D	E	F	CJBDT	
VIS-CJBDT-9/9	310	270	-	-	200	80	9/9	
VIS-CJBDT-10/10	336	298	-	-	200	80	10/10	
VIS-CJBDT-12/12	397	351	-	-	300	80	12/12	
VIS-CJBDT-15/15	480	414	-	-	300	80	15/15	
VIS-CJBDT-18/18	552	493	-	-	300	80	18/18	
VIS-CJBDT-20/20	612	615	-	-	500	80	20/20	
VIS-CJBDT-22/22	666	706	-	-	500	80	22/22	
	A	B	C	D	E	F	CJMP	CJTCR/R
VIS-820	132	157	-	-	170	56,5	820	-
VIS-922	142	216	-	-	215	56,5	922	-
VIS-1025	167	251	-	-	240	56,5	1025	-
VIS-1128	182	296	-	-	270	56,5	1128	-

VIS-1231	202	321	-	-	290	56,5	1231	-
VIS-1240	317	401	-	-	350	56,5	-	1240
VIS-1435	232	281	-	-	260	56,5	1435	-
VIS-1445	357	451	-	-	385	56,5	-	1445
VIS-1640	252	321	-	-	290	56,5	1640	-
VIS-650	402	501	-	-	420	56,5	-	1650
VIS-1845	286	361	-	-	320	56,5	1845	-
VIS-1856	452	561	-	-	-	-	-	1856
VIS-2050	317	451	-	-	385	56,5	2050	-
VIS-2063	502	631	-	-	515	56,5	-	2063
VIS-2271	562	716	-	-	575	56,5	-	2271
	A	B	C	D	E	F	CJLINE	CJS
VIS-1131	560	450	-	-	250	100	1131	-
VIS-1235	620	500	-	-	250	100	1235	-
VIS-1640/E	710	560	-	-	250	100	1640	-
VIS-1845/E	800	630	-	-	250	100	1845/1650/H	-
VIS-1856/E	1000	800	-	-	250	100	1856-1856/H	-
VIS-2063/E	1120	900	-	-	250	100	2063-2063/H	-
VIS-2271/E	1190	900	-	-	250	100	2271-2271/H	-
VIS-2880	1250	1000	-	-	250	100	2880	-
VIS-100	600	600	698	698	485	-	-	1240/1850
VIS-200	725	725	823	823	576	-	-	2056/2263-6T
VIS-300	800	800	898	898	630	-	-	2263-4T/2071-6T-3
VIS-400	860	860	958	958	674	-	-	-2071-4T/6T-5,5/2880



PA

Placa de adaptación para montaje de accesorios, en extractores de tejado

Características:

- Se utiliza para el montaje de los accesorios PT, B, BTUB, BAC. Permite separar el ventilador de su base sin desmontar el conjunto de accesorios

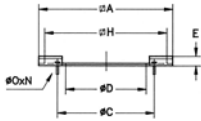

	∅A	∅C	∅D	E	∅H	∅O	N
PA-345	345	200	165	20	245	M.8	4x90°
PA-390	390	210	190	20	320	M.8	4x90°
PA-440/250	440	280	249	20	360	M.6	4x90°
PA-490	490	355	314	20	410	M.8	8x45°
PA-550	550	395	354	20	450	M.6	8x45°
PA-620	620	450	399	20	530	M.10	8x45
PA-700/500	700	560	499	20	590	M.10	12x30°
PA-700/450	700	500	449	20	590	M.10	8x45°
PA-790	790	560	499	20	680	M.10	12x30°

	∅A	∅C	∅D	E	∅H	∅O	N
PA-890/630	890	690	629	20	750	M.10	12x30°
PA-890/560	890	620	559	20	750	M.10	12x30°
PA-990/630	990	690	629	20	850	M.10	12x30°
PA-990/710	990	770	709	20	850	M.10	16x22°30'
PA-1085	1085	770	704,5	20	900	M.10	16x22°30'
PA-1138/800	1138	860	799	25	1000	M.10	16x22°30'
PA-1138/900	1138	970	899	25	1000	M.12	16x22°30'
PA-1238	1238	1070	999	25	1100	M.12	16x22°30'

Modelo	CHT	HT	CHRE
PA-345	-	-	722
PA-390	-	-	825
PA-440/250	200/225	25	1131
PA-490	-	31	-
PA-550	250/315	35	1135/1240
PA-620	-	40	-
PA-700/500	400/450	-	1445/1650
PA-700/450	-	45	-
PA-790	-	50	-
PA-890/630	500	-	-
PA-890/560	-	56	-
PA-990/630	-	63	-
PA-990/710	-	71	-
PA-1085	560/630	-	-
PA-1138/800	-	80	-
PA-1138/900	-	90	-
PA-1238	-	100	-



BS BSS

Base soporte elevada y base soporte elevada con silenciador

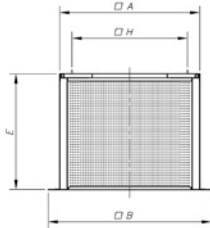

Modelo	A	B	H	E	CHT/CVT	HT	CHRE
BS BSS - 348	348	520	295	800	-	-	722
BS BSS - 393	393	565	320	800	-	-	825
BS BSS - 443	449	616	360	800	200/225	25	1131
BS BSS - 493	493	665	410	800	-	31	-
BS BSS - 553	554	724	450	800	250/315	35	1135/1240
BS BSS - 623	623	795	530	800	-	40	-
BS BSS - 701	706	876	590	900	400/450	45	1445-1650
BS BSS - 791	791	965	680	900	-	50	-
BS BSS - 891	896	1076	750	900	500	56	-
BS BSS - 991	991	1165	850	900	-	63/71	-
BS BSS - 1086	1092	1272	900	900	560/630	-	-
BS BSS - 1140	1140	1314	1000	900	-	80/90	-
BS BSS - 1240	1240	1414	1100	900	-	100	-

PT

Obtadores de cierre automático para trabajo vertical y horizontal versión 400 certificada 400°C/2h

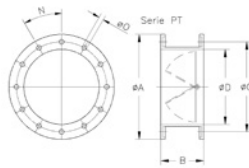

	ØA	B	ØC	ØD*	ØO	N	CHT/CVT	CHRE
PT-160	220	150	200	160	10	4x90°		722
PT-180	240	150	210	180	10	4x90°		825
PT-250	310	150	280	250	10	4x90°	200/225	1131
PT-355	435	200	395	355	10	8x45°	250/315	1135/1240
PT-500	600	280	560	500	12	12x30°	400/450	1445/1650
PT-630	730	355	690	630	12	12x30°		500
PT-710	810	400	770	710	12	16x22°30'	560/630	

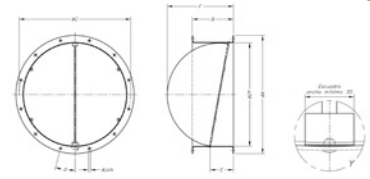
PT/H

	ØA	B	ØC	ØD*	E	F	ØJ	ØK	ØL	ØM	ØN
PT-450/H	540	254	500	460	185	340	22° 30'	12			8x45°
PT-500/H	600	254	560	514	185	346	15°	12			12x30°
PT-560/H	660	254	620	560	185	363	15°	12			12x30°
PT-630/H	730	254	690	640	185	409	15°	12			12x30°
PT-710/H	810	254	770	710	185	443	11°15'	12			16x22°30'
PT-800/H	900	254	860	800	185	488	11°15'	12			16x22°30'
PT-900/H	1015	254	970	900	185	555	11°15'	15			16x22°30'
PT-1000/H	1115	254	1070	1000	185	609	11°15'	15			16x22°30'
PT-1250/H	1365	254	1320	1250	185	736,5	9°	15			20x18°

BIC

Brida conversión de rectangular a circular para ventiladores centrífugos

Características:

- Se adapta a la boca de impulsión
- Facilita la instalación al conducto circular

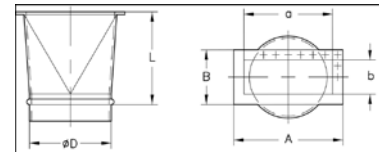

Modelo	L	D	a	b	A	B	Aplicable a modelos
BIC-820-CB	300	200	160	130	213	184	CB-820
BIC-1428	300	250	286	202	350	260	CB-1428
BIC-1733	300	280	339	240	415	315	CB-1733
BIC-2240	450	355	400	300	478	372	CB-2240
BIC-628	200	150	86	86	130	130	CMC-628
BIC-630	200	150	86	86	130	130	CMC-630
BIC-835	200	200	91	91	141	141	CMC-835
BIC-840	200	200	91	91	141	141	CMC-840
BIC-242	200	100	95	60	155	120	CAS/CAST-242
BIC-248	200	112	105	66	165	126	CAS/CAST-248
BIC-254	200	125	115	75	175	135	CAS/CAST-254
BIC-260	200	150	125	85	185	145	CAS/CAST-260
BIC-463	200	200	125	85	185	145	CAS/CAST-463
BIC-467	250	224	130	90	190	150	CAS/CAST-467
BIC-571	250	250	145	95	205	155	CAS/CAST-571
BIC-640	250	250	200	125	260	185	CAS/CAST-640
BIC-645	250	250	224	140	284	200	CAS/CAST-645
BIC-650	250	250	250	160	310	220	CAS/CAST-650
BIC-680	250	180	100	71	160	131	CAS-680
BIC-790	250	180	112	80	172	140	CAS-790
BIC-852	250	280	280	180	340	240	CAS/CAST-852
BIC-856	280	355	280	180	340	240	CAS/CAST-856
BIC-863	280	355	315	200	375	260	CAS/CAST-863
BIC-971	280	400	355	224	425	294	CAS/CAST-971
BIC-980	300	250	200	140	270	210	CAS/CAST-980
BIC-990	300	280	224	160	294	230	CAS-990
BIC-1080	300	250	200	140	270	210	CAS-1080
BIC-1090	300	280	224	160	294	230	CAS-1090
BIC-1250	450	400	400	280	480	360	CAS/CAST-1250/A
BIC-1456	450	450	450	315	530	395	CAS/CAST-1456/A
BIC-1663	450	500	500	355	580	435	CAS/CAST-1663/A
BIC-1671	450	630	560	400	660	500	CAS-1671/A-2071/A
BIC-2080	450	710	630	450	730	550	CAS-2080/A
BIC-540	300	180	140	120	224	206	CAM-540
BIC-545	300	180	170	135	255	222	CAM-545
BIC-550	300	224	200	150	296	246	CAM-550
BIC-752	300	224	200	160	296	256	CAM-752
BIC-760	300	250	220	180	316	276	CAM-760
BIC-880	300	315	290	190	360	249	CAM-880
BIC-1445/E	450	450	450	355	538	445	CBP-1445
BIC-1650/E	450	500	500	400	590	490	CBP-1650
BIC-1856/E	450	560	560	450	660	550	CBP-1856

Modelo	L	D	a	b	A	B	Aplicable a modelos
BIC-512	300	112	86	75	118	104	CMP-512
BIC-514	300	140	107	83	147	122	CMP-514
BIC-616	300	160	125	103	172	153	CMP-616
BIC-620	300	200	100	105	153	159	CMP-620
BIC-718	300	180	146	115	192	169	CMP-718
BIC-820	300	200	156	160	213	184	CMP-820
BIC-922	300	224	216	140	282	204	CMP-922
BIC-1025	300	250	250	165	314	229	CMP-1025
BIC-1128	300	280	300	180	364	244	CMP-1128
BIC-1231	300	315	320	200	384	266	CMP-1231
BIC-1435	300	355	280	228	344	294	CMP-1435
BIC-1640	300	400	320	250	404	336	CMP-1640
BIC-1845	450	450	360	284	444	370	CMP-1845
BIC-2050	450	500	450	315	545	412	CMP-2050
BIC-2563	450	630	600	410	706	512	CMP-2563
BIC-922-T	300	180	216	140	282	204	CMT-922
BIC-1025-T	300	200	250	165	314	229	CMT-1025
BIC-1128-T	300	224	300	180	364	244	CMT-1128
BIC-1231-T	300	250	320	200	384	266	CMT-1231
BIC-1435-T	300	280	280	228	344	294	CMT-1435
BIC-1640-T	300	280	320	250	404	336	CMT-1640
BIC-1845-T	450	355	360	284	444	370	CMT-1845
BIC-2050-T	450	400	450	315	545	412	CMT-2050
BIC-622	250	152	150	120	191,5	180	CMR-622
BIC-625	250	165	167,5	125	207,5	185	CMR-625
BIC-728	250	185	187,5	136,5	234,5	196,5	CMR-728
BIC-731	250	200	211	130,5	250,5	190,5	CMR-731
BIC-1031	300	315	315	250	385	320	CMR-1031
BIC-1135	450	355	355	280	425	350	CMR-1135
BIC-1240	450	400	400	315	480	395	CMR-1240
BIC-1445	450	450	450	355	540	445	CMR-1445
BIC-1650	450	500	500	400	590	490	CMR-1650
BIC-1856	450	560	560	450	660	550	CMR-1856
BIC-2063	450	630	630	500	750	620	CMR-2063
BIC-2271	450	710	710	560	840	690	CMR-2271
BIC-2380	600	800	800	560	920	680	CMR-2380
BIC-2380/E	600	800	1120	560	1246	690	CMR-2380-X
BIC-2590	600	900	900	630	1020	750	CMR-2590
BIC-28100	600	1000	1000	710	1120	830	CMR-28100
BIC-1840	150	370	273	210	353	303	CPV-1840
BIC-2045	190	400	330	270	420	360	CPV-2045



EFFICIENT WORK



ACE

Acoplamiento elástico para amortiguar vibraciones

Características:

- Se utiliza entre la boca del ventilador y el conducto para evitar la transmisión de vibraciones

Aplicable a los modelos (ASPIRACIÓN)

Aplicable a los modelos (IMPULSIÓN)

CMAT	Aplicable a los modelos (ASPIRACIÓN)									Aplicable a los modelos (IMPULSIÓN)										
	CMA	CB	CAS	CA	CAM	CMP	CMT	CBP	CMR-X	CMC	CMA	CAS	CA	CAM	CB	CMP	CMT	CMR-X	CMC	
ACE-52	-	-	-	-	-	-	-	-	-	-	-	-	-	-	-	-	-	-	-	234
ACE-63	-	-	-	-	-	-	-	-	-	-	218/324	-	-	-	-	-	-	-	-	142
ACE-80	218/324	-	-	-	-	-	-	-	-	-	325	-	-	148/154/160/166	-	-	-	-	-	-
ACE-100	325	-	242	234/142	-	-	-	-	-	-	426/527	242	172	-	-	-	-	-	-	-
ACE-112	426	-	248	148	-	512	-	-	-	-	-	248	-	-	-	512	-	-	-	-
ACE-125	527/528	-	254	154	-	-	-	-	-	-	528	254	-	-	-	-	-	-	-	-
ACE-140	-	-	-	-	-	514	-	-	-	-	-	-	-	-	-	514	-	-	-	-
ACE-150	531	-	260	160	-	-	-	-	-	628/630	531/540	260	-	-	-	-	-	-	-	628/630
ACE-160	-	-	680	-	-	616	-	-	-	-	-	-	-	-	-	616	-	-	-	-
ACE-180	540/545	-	790	166/172	540/545	718	922	-	-	-	545	680/790	-	540/545	-	718	922	-	-	-
ACE-200	-	820	463	-	-	620/820	1025	-	-	835/840	-	463	-	-	820	620/820	1025	-	-	835/840
ACE-224	-	-	467	-	550/752	922	1128	-	-	-	-	467	-	550/752	-	922	1128	-	-	-
ACE-250	-	1428	571/640/645 850/980/1090	-	760	1025	1231	-	-	-	-	570/640/645 850/980/1090	-	760	1428	1025	1231	-	-	-
ACE-280	-	-	852/990/1090	-	-	1128	1435/1640	-	-	-	-	852/990/1090	-	-	1733	1128	1435/1640	-	-	-
ACE-315	-	1733	-	-	880	1231	-	-	1031	-	-	-	-	880	-	1231	-	-	1031	-
ACE-355	-	2240	856/863/1250/A	-	-	1435	1845	-	1135	-	-	856/863	-	-	2240	1435	1845	-	-	1135
ACE-400	-	-	971/1456/A	-	-	1640	2050	-	1240	-	-	971/1250/A	-	-	-	1640	2050	-	-	1240
ACE-450	-	-	-	-	-	1845	-	1445	1445	-	-	1456/A	-	-	-	1845	-	-	1445	-
ACE-500	-	-	-	-	-	2050	-	1650	1650	-	-	1663/A	-	-	-	2050	-	-	1650	-
ACE-560	-	-	1663/A	-	-	-	-	-	1856	1856	-	-	-	-	-	-	-	-	1856	-
ACE-630	-	-	1671/A-2071/A	-	-	2563	-	-	2063	-	-	1671/A-2071/A	-	-	-	2563	-	-	2063	-
ACE-710	-	-	2080/A	-	-	-	-	-	2271	-	-	2080/A	-	-	-	-	-	-	2271	-
ACE-800	-	-	-	-	-	-	-	-	2380	-	-	-	-	-	-	-	-	-	2380	-
ACE-900	-	-	-	-	-	-	-	-	2590	-	-	-	-	-	-	-	-	-	2590	-
ACE-1000	-	-	-	-	-	-	-	-	28100	-	-	-	-	-	-	-	-	-	28100	-



REG

Registro de regulación manual

Características:

- Su construcción permite incorporarlos en los sistemas de conductos, para la regulación del caudal

Modelo	L	ØD*	Modelo	L	ØD*
REG-80	100	80	REG-250	100	250
REG-100	100	100	REG-280	100	280
REG-112	100	112	REG-315	100	315
REG-125	100	125	REG-355	100	355
REG-140	100	140	REG-400	100	400
REG-150	100	150	REG-450	150	450
REG-160	100	160	REG-500	150	500
REG-180	100	180	REG-560	150	560
REG-200	100	200	REG-630	250	630
REG-224	100	224	REG-800	250	800



CJACUS

Cajas acústicas para ventiladores centrífugos

Características:

- Caja de ventilación construida en chapa galvanizada con aislamiento acústico
- Pies soporte y silent-blocks incluidos
- CJACUS/C: Con conexión de aspiración e impulsión al exterior, por medio de conductos. Rejilla para la refrigeración del motor incluida
- CJACUS/L: Con aspiración libre por medio de rejilla, incorporada en la caja y conexión de impulsión al exterior

Aplicable a los modelos

Modelo	CAS	CA	CAM
CJACUS-0	640	154	540
CJACUS-1	254/645	160	545
CJACUS-2	260/463/650	166	550/752
CJACUS-3	467/852/856	172	-
CJACUS-4	571/863	-	760
CJACUS-5	971	-	880



OP

Obturadores de sobrepresión para extractores de tejado

OP-25	HT-25	OP-40	HT-40	OP-56	HT-56	OP-80	HT-80
OP-31	HT-31	OP-45	HT-45	OP-63	HT-63	OP-90	HT-90
OP-35	HT-35	OP-50	HT-50	OP-71	HT-71	OP-100	HT-100



S Silenciadores para acoplar a la aspiración o impulsión.

Características:

- Silenciadores circulares o rectangulares para acoplar a la aspiración o impulsión, de ventiladores centrífugos o helicoidales

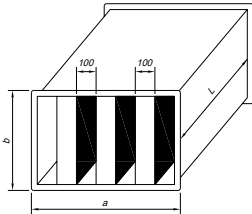

ASPIRACIÓN / IMPULSIÓN (Sección rectangular)

	L	a	b	Kg	Amortiguación de sustitución (dB) en banda de octavos (Hz)						Aplicable
					125	250	500	1000	2000	4000	
SR-1000/900/900	900	1000	900	64	4	10	21	37	44	37	HCH/HCT/THT-63
SR-1200/900/900	900	1200	900	74	4	10	21	37	44	37	HCH/HCT/THT-71
SR-1400/1200/900	900	1400	1200	102	4	12	25	41	47	42	HCH/HCT/THT-80
SR-1800/1200/1200	1200	1800	1200	169	4	12	25	41	47	42	HCH/HCT/THT-90
SR-1800/1500/1200	1200	1800	1504	195	4	12	25	41	47	42	HCH/HCT/THT-100

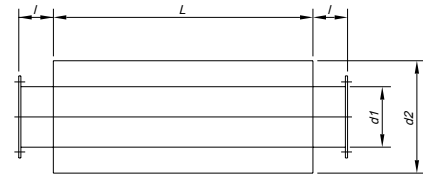
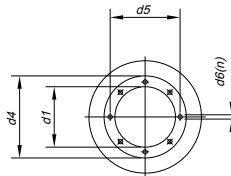

ASPIRACIÓN / IMPULSIÓN (Sección circular)

	L	d1	d2	l	d3	d4	d5	d6	n	Kg	Amortiguación de sustitución (dB) en banda de octavos (Hz)						Aplicable
											125	250	500	1000	2000	4000	
SC-630/900	900	630	800	100	630	720	690	12	12x30°	44	5	8	14	12	13	9	HCH/HCT/THT-63
SC-710/900	900	710	900	100	710	800	770	12	16x22°30'	65	5	8	13	11	12	8	HCH/HCT/THT-71
SC-800/900	900	800	1000	100	800	900	860	12	16x22°30'	70	4	8	11	9	9	8	HCH/HCT/THT-80
SC-900/1200	1200	900	1120	100	900	1000	970	15	16x22°30'	87	5	7	11	11	7	5	HCH/HCT/THT-90
SC-1000/1200	1200	1000	1200	100	1000	1100	1070	15	16x22°30'	95	4	7	11	10	7	6	HCH/HCT/THT-100

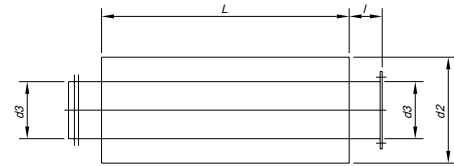
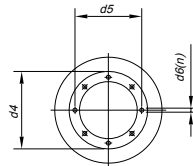

ASPIRACIÓN

	L	d2	d3	d4	d5	d6	n	Kg	Amortiguación de sustitución (dB) en banda de octavos (Hz)						Aplicable	
									125	250	500	1000	2000	4000		
S-160/600-A	600	260	160	220	200	10	4x90°	6	3	11	22	33	42	29		CHRE-722
S-180/600-A	600	300	180	240	210	10	4x90°	7	4	8	15	31	28	20		CHRE-825
S-250/600-A	600	450	250	310	280	10	4x90°	14	5	12	20	24	23	14		CVT-CHT-200/225 HT-25 / CHRE-1131
S-315/900-A	900	500	315	390	355	10	8x45°	22	4	12	21	26	19	15		HT-31
S-355/900-A	900	560	355	430	395	10	8x45°	25	4	12	20	24	18	14		CVT-CHT-250/315 HT-35 / CHRE-1135/1240
S-400/900-A	900	600	400	480	450	12	8x45°	29	5	12	19	22	18	13		HT-40
S-450/900-A	900	630	450	530	500	12	8x45°	32	5	12	18	20	16	12		HT-45
S-500/900-A	900	710	500	590	560	12	12x30°	35	4	11	18	16	14	11		CVT-CHT-400/450 HT-50 / CHRE-1445/1650
S-560/900-A	900	750	560	650	620	12	12x30°	41	4	10	16	14	13	10		HT-56
S-630/900-A	900	800	630	720	690	12	12x30°	44	5	8	14	12	13	9		CVT-CHT-500 / HT-63
S-710/900-A	900	900	710	800	770	12	16x22°30'	65	5	8	13	11	12	8		CVT-CHT-560/630 HT-71
S-800/900-A	900	1000	800	900	860	12	16x22°30'	70	4	8	11	9	9	8		HT-80
S-900/1200-A	1200	1120	900	1000	970	12	16x22°30'	85	5	7	11	11	7	6		HT-90
S-1000/1200-A	1200	1200	1000	1100	1070	12	16x22°30'	95	4	7	11	10	7	6		HT-100



EFFICIENT WORK



Índice Alfabético de Referencias. VENTILADORES

CAS-L/EW	66	CMA/EW	40	HEPT/EW	17
CAS/EW	70	CMP-L/EW	45	HFT/EW	26
CBD/B/EW	34	CMP/EW	51	HT-L/EW	90
CBD/EW	34	CMR-L/EW	57	HT/EW	93
CHT/EW	86	CMR/EW	60	NEOLINEO/EW	13
CJBD/EW	36	CVT/EW	86	OVERPRESSURE KIT	96
CJBD/EW/AL	36	HC/EW	22	SV/ECO	11
CJEC/EW	83	HCH/EW	26	TCR/R/EW	76
CJLINE/EW	80	HCT/EW	26		
CJTGR/R/EW	76	HEP/EW	15		



Índice Alfabético de Referencias. ACCESORIOS

ACE	114	OP	114	SI-CO2	103
AET	108	P	108	SI-FUENTE DE ALIMENTACIÓN	103
B	110	PA	112	SI-HUMEDAD	104
BAC	111	PL	108	SI-PIR	103
BD	110	PS	111	SI-PRESIÓN	104
BIC	113	PSB	111	SI-SMOKE	103
BOXPRES KIT	105	PT	113	SI-TEMP	104
BOXPRES KIT/B	105	PT/H	113	SI-TEMP+HUMEDAD	103
BS	112	PV	109	SI-TIMER	104
BSS	112	R	108	TEJ	111
BTUB	110	REG	114	VIS	112
CJACUS	114	RI	109	VSD1/A-RFM	102
INT	108	RPA	109	VSD1/B	102
KIT CAUDAL CONSTANTE	104	RT	109	VSD3/A-RFT	102
MS	111	S	115	VSD3/B	102
MTP010	103	SI CONTROL PRESIÓN	104		

QUICKFAN
SODECA SELECTOR

NUEVO
SOFTWARE DE
SELECCIÓN



Nuestra **nueva herramienta** que le facilitará la elección del producto más adecuado para su instalación de ventilación.

QUICKFAN

SODECA SELECTOR



BÚSQUEDA
FÁCIL



INFORMES
PERSONALIZABLES



SIEMPRE
ACTUALIZADO



SODECA





Ctra. de Berga, km 0,7
E-08580 SANT QUIRZE DE BESORA
(Barcelona - Spain)
Tel. +34 93 852 91 11
Fax +34 93 852 90 42
comercial@sodeca.com
Export sales: ventilation@sodeca.com
www.sodeca.com



Red Comercial España

Barcelona

Ctra. De Berga, km. 0'700
08580 Sant Quirze de Besora (Barcelona)
Tel. 938529111 - Fax 938529042
comercial@sodeca.com
Provincias: Barcelona, Tarragona, Lleida y Girona

Baleares

Sr. José Ignacio Francisco Sánchez
Móvil: 682 912 100
ifrancisco@sodeca.com
Provincias: Baleares

Bilbao

Pitalven S.L.
Sr. Jon Garin
Pza. Jaro de Arana, 3 4º
48012 Bilbao
Tel./Fax 944214223
Móvil 615749646
jgarin@sodeca.com
Provincias: Vizcaya, Guipúzcoa, Álava,
Santander, Navarra y Rioja

Canarias

Stra. Mª del Mar Castilla
Carretera General del Sobradillo, 45, A
El Sobradillo 38107
Santa Cruz de Tenerife
Tfno./fax 822.174.111
mcastilla@sodeca.com
Provincias: Islas Canarias

Córdoba

Sr. Juan Manuel Ceballos
Imprenta de la Alborada, parc.224, nº 1
14014 Córdoba
Tel. 957325512 - Fax 957325274

Móvil 689637163

jceballos@sodeca.com
Provincias: Sevilla, Huelva, Cádiz, Córdoba,
Jaén, Cáceres y Badajoz

A Coruña

Sr. Ricard Fernández
Rua a Granxa, 6 (Lorbe)
15177 Oleiros
Tel./Fax 981628196
Móvil 615145104
rfernandez@sodeca.com
Provincias: A Coruña, Lugo, Ourense y
Pontevedra

Gijón

Sr. Roberto González
Cean Bermúdez, 12 bajo
33208/ Gijón (Asturias)
Tel. 985149581 - Fax 985165313
Móvil 629073929
rgonzalez@sodeca.com
Provincias: Asturias y León

Madrid

Stra. Almudena Hernández
C. Tabernillas, 6
28005 Madrid
Tel. 913667045
Fax 913666045
Móvil 670744420
sodecacentro@sodeca.com
Provincias: Madrid, Toledo, Ciudad Real,
Guadalajara, Segovia, Ávila, Cuenca y Zamora
Móvil 682823139
sodecacastilla@sodeca.com
Provincias: Salamanca, Valladolid,
Palencia y Burgos

Murcia

Sr. Francisco José Hurtado
Apartado de Correos 6103
30080 Murcia
Tel. 675767025 - Fax 968970250
hurtado@sodeca.com
Provincias: Murcia, Almería, Granada y
Málaga

Valencia

Tacifer s.l.
Sr. Javier Talens
Timoneda, 8, 1º
46008 Valencia
Tel. 963841480 - Fax 963820207
Móvil 670696289
javiertalens@sodeca.com
csebastian@sodeca.com
Provincias: Valencia, Castellón, Alicante y
Albacete

Zaragoza

Hernández Silbe s.l.
Stra. Silvia Hernández
Alfonso I, casa 15
50410 Cuarte de Huerva - Zaragoza
Tel. 630263224 - Fax 976937430
sodecaragon@sodeca.com
Provincias: Huesca, Zaragoza, Teruel y Soria



SODECA EXPORT

Ctra. de Berga, km 0,7
E-08580 SANT QUIRZE
DE BESORA
Barcelona - SPAIN
Tel. +34 93 852 91 11
Fax +34 93 852 90 42
ventilation@sodeca.com

SODECA-PORTUGAL DECIFLEX

Sr. Luiz Araújo
Rua Veloso Salgado 1120/1138
4450-801 Leça de Palmeira
Tel. +351 229 991 100
Fax. +351 229 991 119
geral@deciflex.com

SODECA AMÉRICA USA - CANADÁ - MÉXICO AMÉRICA DEL SUR

Sr. Francisc Bertran
Sodeca Ventiladores Ltda
Avda. Puerta Sur 03380
San Bernardo, SANTIAGO, CHILE
ventas.chile@sodeca.com
Tel. +56 (02) 2840 5582

SODECA ÁREA CARIBE

Sr. Carlos A. Hernández Gil
Residencial Miramar N° 120B-7ma
Ave. N° 1805 entre 18 y 20.
Miramar Playa, CIUDAD DE LA
HABANA, CUBA
Tel. 00537 20 43721
sodeca@enet.cu



Ctra. de Berga, km 0,7
E-08580 SANT QUIRZE DE BESORA
(Barcelona - Spain)
Tel. +34 93 852 91 11
Fax +34 93 852 90 42
comercial@sodeca.com
Export sales: ventilation@sodeca.com

www.sodeca.com

