

# THT/WALL

**Extractores dinámicos murales con compuerta de apertura motorizada, para la evacuación de humo en caso de incendio, 400 °C/2h y 300 °C/2h**



Extractores dinámicos murales de apertura motorizada, con posibilidad de ser conectados a conducto de extracción. Especialmente diseñados para la rápida y eficaz evacuación de humo y gases nocivos en caso de incendio. Apto para instalación en naves industriales, edificios comerciales o cualquier otro tipo de edificación. Puede utilizarse para la ventilación ambiental.

**Ventilador:**

- Brida de fijación a pared y pie soporte aro helicoidal para la correcta y fácil instalación.
- Homologación según norma EN 12101-3, con certificaciones n°: 0370-CPR-0305 (F400) y 0370-CPR-0973 (F300).
- Envoltente tubular en chapa de acero con tratamiento anticorrosivo en resina de poliéster.
- Hélice de ángulo variable en fundición de aluminio.
- Cable de potencia apantallado con protección EMC.
- Dirección aire motor-hélice.

**Compuerta de aluminio extruido:**

- Estructura de gran robustez para resistir severas condiciones climáticas.
- Diseñado para asegurar la estanqueidad a la entrada de agua.
- Perfil de aluminio con rotura de puente térmico.
- Plafón central y estructura dotados de aislante térmico de altas prestaciones.
- Resistividad térmica del conjunto menor que 0,89 W/m<sup>2</sup>·K.
- Indicadores de posición en ambas posiciones (abierto y cerrado).

- Versiones de montaje en apertura superior e inferior.
- Sistema de apertura manual.
- Valor del aislamiento acústico al ruido aéreo según UNE-EN ISO 10140-2: Rw = 27 (0;-2) dB.

**Motor:**

- Motores clase H para uso continuo S1 y uso emergencia S2. Con rodamientos a bolas, protección IP55 y 1 o 2 velocidades según modelo.
- Motores con eficiencia IE3.
- Trifásico 230/400 V 50 Hz (hasta 3 kW) y 400/690 V 50 Hz (potencias superiores a 3 kW).
- Temperatura máxima del aire a transportar: Servicio S1 -25 °C +40 °C en continuo, apto también para climas cálidos con temperaturas hasta 50 °C. Servicio S2 300 °C/2h, 400 °C/2h.

**Actuador:**

- Fiabilidad mayor a 20.000 dobles ciclos.
- Tensión de alimentación 230 V AC 50/60 Hz.
- Temperatura de trabajo: -25 °C +60 °C.
- Protección en el borde principal al cerrar la compuerta.
- El tope en la posición de cierre está regulado por un control de final de carrera electrónico.

**Acabado compuerta:**

- Anticorrosivo en aluminio extruido.
- Color estándar RAL 7016. Bajo demanda cualquier color de la carta RAL.

**Bajo demanda:**

- Actuador con tensión de alimentación 24 V DC.

## Código de pedido

De tamaño 40 a tamaño 56

**THT/WALL - A/B - 56 - 4T - 2 - F400**

THT/WALL: Extractores dinámicos murales con compuerta de apertura motorizada, para la evacuación de humo en caso de incendio, 400 °C/2h y 300 °C/2h

Apertura compuerta  
A/B = Instalación abatible o basculante

Diámetro hélice en cm

Número de polos motor  
2=3000 r/min 50 Hz  
4=1500 r/min 50 Hz  
6=1000 r/min 50 Hz

T = Trifásico

Potencia motor (CV)

F300: Homologación 300 °C/2h  
F400: Homologación 400 °C/2h

De tamaño 63 a tamaño 125

**THT/WALL - A - 125 - 4T / 6 - 30 - F400**

THT/WALL: Extractores dinámicos murales con compuerta de apertura motorizada, para la evacuación de humo en caso de incendio, 400 °C/2h y 300 °C/2h

Apertura compuerta  
A = Abatible (Bisagras parte inferior)  
B = Basculante (Bisagras parte superior)

Diámetro hélice en cm

Número de polos motor  
4=1500 r/min 50 Hz  
6=1000 r/min 50 Hz

T = Trifásico

Número de palas:  
6 palas  
9 palas  
12 palas

Potencia motor (CV)

F300: Homologación 300 °C/2h  
F400: Homologación 400 °C/2h

## Características técnicas

Modelo	Velocidad (r/min)	Intensidad máxima admisible (A)			Potencia instalada (kW)	Ángulo inclinación palas (°)	Caudal máximo (m³/h)	Nivel presión sonora <sup>1</sup> dB (A)		Peso aprox. (Kg)
		230V	400V	690V				Aspiración	Descarga	
THT/WALL-40-2T-1 IE3	2850	2,76	1,59		0,75	16	6100	62	62	62
THT/WALL-40-2T-1.5 IE3	2880	3,93	2,26		1,10	20	7040	61	61	63
THT/WALL-45-2T-2 IE3	2880	4,91	2,84		1,50	16	9400	61	61	67
THT/WALL-45-2T-3 IE3	2840	7,14	4,13		2,20	22	11325	61	61	68
THT/WALL-50-2T-4 IE3	2880	9,61	5,52		3,00	16	13860	66	66	84
THT/WALL-50-2T-5.5 IE3	2870		7,20	4,17	4,00	20	15900	66	66	100
THT/WALL-56-2T-5.5 IE3	2870		7,20	4,17	4,00	16	18820	68	68	105
THT/WALL-56-2T-7.5 IE3	2910		10,10	5,80	5,50	22	22510	68	68	107
THT/WALL-56-4T-2 IE3	1440	5,89	3,38		1,50	36	15020	54	54	84
THT/WALL-63-4T-3 IE3	1425	7,86	4,52		2,20	32	22170	58	58	131
THT/WALL-63-4T-4 IE3	1430	11,01	6,33		3,00	38	24240	59	59	132
THT/WALL-63-6T-1 IE3	940	3,36	1,93		0,75	38	15890	48	48	121
THT/WALL-71-4T-3 IE3	1425	7,86	4,52		2,20	22	25100	60	60	124
THT/WALL-71-4T-4 IE3	1430	11,01	6,33		3,00	28	27480	60	60	133
THT/WALL-71-4T-5.5 IE3	1440		7,95	4,61	4,00	38	32250	61	61	143
THT/WALL-71-6T-1.5 IE3	945	4,73	2,72		1,10	34	19930	51	51	123
THT/WALL-80-4T-3 IE3	1425	7,86	4,52		2,20	12	25460	65	65	138
THT/WALL-80-4T-4 IE3	1430	11,01	6,33		3,00	16	30270	64	64	147
THT/WALL-80-4T-5.5 IE3	1440		7,95	4,61	4,00	18	32770	63	63	153
THT/WALL-80-4T-7.5 IE3	1460		10,40	6,04	5,50	26	39640	63	63	154
THT/WALL-80-6T-1.5 IE3	945	4,73	2,72		1,10	18	21470	53	53	137
THT/WALL-80-6T-2 IE3	945	6,25	3,62		1,50	26	25970	54	54	146
THT/WALL-90-4T-7.5 IE3	1460		10,40	6,04	5,50	18	46140	67	67	222
THT/WALL-90-4T-10 IE3	1460		14,20	8,17	7,50	22	50140	66	66	233
THT/WALL-90-4T-15 IE3	1460		20,70	11,99	11,00	30	59390	68	68	242
THT/WALL-90-6T-3 IE3	950	9,78	5,62		2,20	24	34000	56	56	195
THT/WALL-90-6T-4 IE3	970	12,80	6,36		3,00	30	38910	59	59	221
THT/WALL-100-4T-10 IE3	1460		14,20	8,17	7,50	16	57420	69	69	239
THT/WALL-100-4T-15 IE3	1460		20,70	11,99	11,00	22	66300	69	69	292
THT/WALL-100-4T-20 IE3	1460		27,80	16,03	15,00	28	76160	70	70	307
THT/WALL-100-6T-5.5 IE3	970	8,37	4,82		4,00	26	47780	60	60	239
THT/WALL-100-6T-7.5 IE3	970	12,30	7,07		5,50	32	53520	62	62	276
THT/WALL-125-4T/6-20 IE3	1460		27,80	16,03	15,00	10	78600	77	77	462
THT/WALL-125-4T/6-25 IE3	1465		35,40	20,39	18,50	14	92550	76	76	530
THT/WALL-125-4T/6-30 IE3	1470		42,20	24,44	22,00	16	98830	75	75	544
THT/WALL-125-4T/6-40 IE3	1475		53,30	31,02	30,00	22	117450	75	75	625
THT/WALL-125-4T/6-50 IE3	1480		66,40	38,26	37,00	26	131050	75	75	673
THT/WALL-125-4T/9-25 IE3	1465		35,40	20,39	18,50	10	79650	77	77	539
THT/WALL-125-4T/9-30 IE3	1470		42,20	24,44	22,00	12	88290	76	76	553
THT/WALL-125-4T/9-40 IE3	1475		53,30	31,02	30,00	16	104040	75	75	634
THT/WALL-125-4T/9-50 IE3	1480		66,40	38,26	37,00	20	118400	75	75	682
THT/WALL-125-4T/12-30 IE3	1475		42,20	24,44	22,00	10	62900	78	78	569
THT/WALL-125-4T/12-40 IE3	1470		53,30	31,02	30,00	14	79180	77	77	650
THT/WALL-125-4T/12-50 IE3	1480		66,40	38,26	37,00	18	95715	76	76	693
THT/WALL-125-6T/6-5.5 IE3	970		8,37	4,82	4,00	10	51500	67	67	395
THT/WALL-125-6T/6-7.5 IE3	970		12,30	7,07	5,50	14	60640	65	65	402
THT/WALL-125-6T/6-10 IE3	960		15,20	8,83	7,50	20	72650	64	64	427
THT/WALL-125-6T/6-15 IE3	955		22,50	13,07	11,00	26	85850	64	64	457
THT/WALL-125-6T/6-20 IE3	950		29,00	16,78	15,00	30	92850	66	66	530
THT/WALL-125-6T/9-10 IE3	960		15,20	8,83	7,50	14	63490	67	67	436
THT/WALL-125-6T/9-15 IE3	955		22,50	13,07	11,00	20	77550	65	65	466
THT/WALL-125-6T/9-20 IE3	950		29,00	16,78	15,00	26	92950	65	65	539
THT/WALL-125-6T/9-25 IE3	975		36,10	20,77	18,50	32	96500	67	67	569
THT/WALL-125-6T/12-25 IE3	975		36,10	20,77	18,50	28	91680	67	67	579
THT/WALL-125-6T/12-30 IE3	975		42,30	24,35	22,00	32	102050	68	68	621
THT/WALL-125-6T/12-40 IE3	980		55,80	32,13	30,00	38	115950	72	72	739

<sup>1</sup> Los valores de los niveles sonoros, son presiones en dB(A) medidos a 10 metros, en campo libre.

## Características técnicas del exutorio dinámico según normas EN-12101-3

Modelo	Homologación (°C)	Clase aislamiento motor	Durabilidad	Temperatura ambiente mínima (°C)	Carga de viento (Pa)
THT/WALL	F300 y F400	Clase H	RE >20000	-25	WL 200



### Erp. (Energy Related Products)

Información de la Directiva 2009/125/EC descargable desde la web de SODECA o programa de selección QuickFan.

## Características acústicas

Los valores indicados se obtienen en condiciones de laboratorio según la norma ISO 3744.  
Espectro de potencia sonora Lw(A) en dB(A) por banda de frecuencia en Hz

### Valores tomados a la aspiración con caudal máximo

	63	125	250	500	1000	2000	4000	8000
40-2-1	48	64	76	84	89	87	83	76
40-2-1.5	47	63	75	83	88	86	82	75
45-2-2	47	60	74	86	87	86	82	74
45-2-3	47	64	74	81	88	86	83	75
50-2-4	58	74	84	91	92	89	88	89
50-2-5.5	58	74	84	91	92	89	88	89
56-2-5.5	53	66	84	92	94	93	88	81
56-2-7.5	53	66	84	92	94	93	88	81
56-4-2	52	64	73	79	79	79	73	65
63-4-3	56	68	77	83	83	83	77	69
63-4-4	57	69	78	84	84	84	78	70
63-6-1	49	59	69	73	74	72	65	57
71-4-3	56	72	79	85	85	85	81	73
71-4-4	63	75	79	85	85	86	83	75
71-4-5.5	64	76	80	86	86	87	84	76
71-6-1.5	47	65	74	77	77	72	65	56
80-4-3	55	71	84	91	91	88	82	74
80-4-4	54	70	83	90	90	87	81	73
80-4-5.5	53	69	82	89	89	86	80	72
80-4-7.5	53	69	82	89	89	86	80	72
80-6-1.5	53	68	75	78	79	76	70	62
80-6-2	59	69	75	79	80	78	73	65
90-4-7.5	59	75	86	92	93	91	86	78
90-4-10	58	74	85	91	92	90	85	77
90-4-15	60	76	87	93	94	92	87	79
90-6-3	52	67	78	82	82	78	71	63
90-6-4	60	70	80	85	85	82	76	68
100-4-10	64	80	87	94	95	93	89	81
100-4-15	71	83	87	93	94	94	91	83
100-4-20	72	84	88	94	95	95	92	84
100-6-5.5	57	72	82	85	86	83	75	67
100-6-7.5	59	74	84	87	88	85	77	69
125-4/6-20	69	85	96	103	104	102	95	87
125-4/6-25	68	84	95	102	103	101	94	86
125-4/6-30	67	83	94	101	102	100	93	85
125-4/6-40	67	83	94	101	102	100	93	85
125-4/6-50	67	83	94	101	102	100	93	85
125-4/9-25	67	81	94	102	104	101	96	88
125-4/9-30	66	80	93	101	103	100	95	87
125-4/9-40	65	79	92	100	102	99	94	86
125-4/9-50	65	79	92	100	102	99	94	86
125-6/6-5.5	64	79	89	92	93	90	85	77
125-6/6-7.5	62	77	87	90	91	88	83	75
125-6/6-10	61	76	86	89	90	87	82	74
125-6/6-15	61	76	86	89	90	87	82	74
125-6/6-20	63	78	88	91	92	89	84	76
125-6/9-10	61	76	87	93	94	88	84	77
125-6/9-15	59	74	85	91	92	86	82	75
125-6/9-20	59	74	85	91	92	86	82	75
125-6/9-25	61	76	87	93	94	88	84	77
125-4/12-30	68	82	95	103	105	102	97	89
125-4/12-40	67	81	94	102	104	101	96	88
125-4/12-50	66	80	93	101	103	100	95	87
125-6/12-25	61	76	87	93	94	88	84	77
125-6/12-30	62	77	88	94	95	89	85	78
125-6/12-40	66	81	92	98	99	93	89	82

### Valores tomados a la descarga con caudal máximo

	63	125	250	500	1000	2000	4000	8000
40-2-1	48	64	76	84	89	87	83	76
40-2-1.5	47	63	75	83	88	86	82	75
45-2-2	47	60	74	86	87	86	82	74
45-2-3	47	64	74	81	88	86	83	75
50-2-4	58	74	84	91	92	89	88	89
50-2-5.5	58	74	84	91	92	89	88	89
56-2-5.5	53	66	84	92	94	93	88	81
56-2-7.5	53	66	84	92	94	93	88	81
56-4-2	52	64	73	79	79	79	73	65
63-4-3	56	68	77	83	83	83	77	69
63-4-4	57	69	78	84	84	84	78	70
63-6-1	49	59	69	73	74	72	65	57
71-4-3	56	72	79	85	85	85	81	73
71-4-4	63	75	79	85	85	86	83	75
71-4-5.5	64	76	80	86	86	87	84	76
71-6-1.5	47	65	74	77	77	72	65	56
80-4-3	55	71	84	91	91	88	82	74
80-4-4	54	70	83	90	90	87	81	73
80-4-5.5	53	69	82	89	89	86	80	72
80-4-7.5	53	69	82	89	89	86	80	72
80-6-1.5	53	68	75	78	79	76	70	62
80-6-2	59	69	75	79	80	78	73	65
90-4-7.5	59	75	86	92	93	91	86	78
90-4-10	58	74	85	91	92	90	85	77
90-4-15	60	76	87	93	94	92	87	79
90-6-3	52	67	78	82	82	78	71	63
90-6-4	60	70	80	85	85	82	76	68
100-4-10	64	80	87	94	95	93	89	81
100-4-15	71	83	87	93	94	94	91	83
100-4-20	72	84	88	94	95	95	92	84
100-6-5.5	57	72	82	85	86	83	75	67
100-6-7.5	59	74	84	87	88	85	77	69
125-4/6-20	69	85	96	103	104	102	95	87
125-4/6-25	68	84	95	102	103	101	94	86
125-4/6-30	67	83	94	101	102	100	93	85
125-4/6-40	67	83	94	101	102	100	93	85
125-4/6-50	67	83	94	101	102	100	93	85
125-4/9-25	67	81	94	102	104	101	96	88
125-4/9-30	66	80	93	101	103	100	95	87
125-4/9-40	65	79	92	100	102	99	94	86
125-4/9-50	65	79	92	100	102	99	94	86
125-6/6-5.5	64	79	89	92	93	90	85	77
125-6/6-7.5	62	77	87	90	91	88	83	75
125-6/6-10	61	76	86	89	90	87	82	74
125-6/6-15	61	76	86	89	90	87	82	74
125-6/6-20	63	78	88	91	92	89	84	76
125-6/9-10	61	76	87	93	94	88	84	77
125-6/9-15	59	74	85	91	92	86	82	75
125-6/9-20	59	74	85	91	92	86	82	75
125-6/9-25	61	76	87	93	94	88	84	77
125-4/12-30	68	82	95	103	105	102	97	89
125-4/12-40	67	81	94	102	104	101	96	88
125-4/12-50	66	80	93	101	103	100	95	87
125-6/12-25	61	76	87	93	94	88	84	77
125-6/12-30	62	77	88	94	95	89	85	78
125-6/12-40	66	81	92	98	99	93	89	82

## Dimensiones mm

A = Abatible

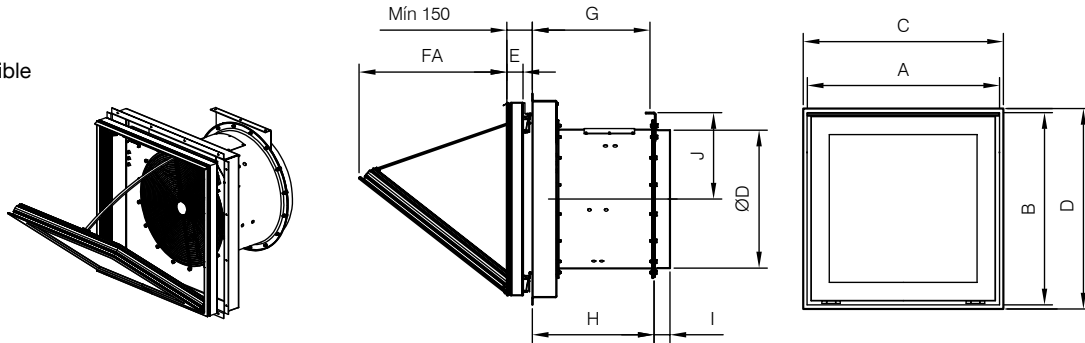

B = Basculante

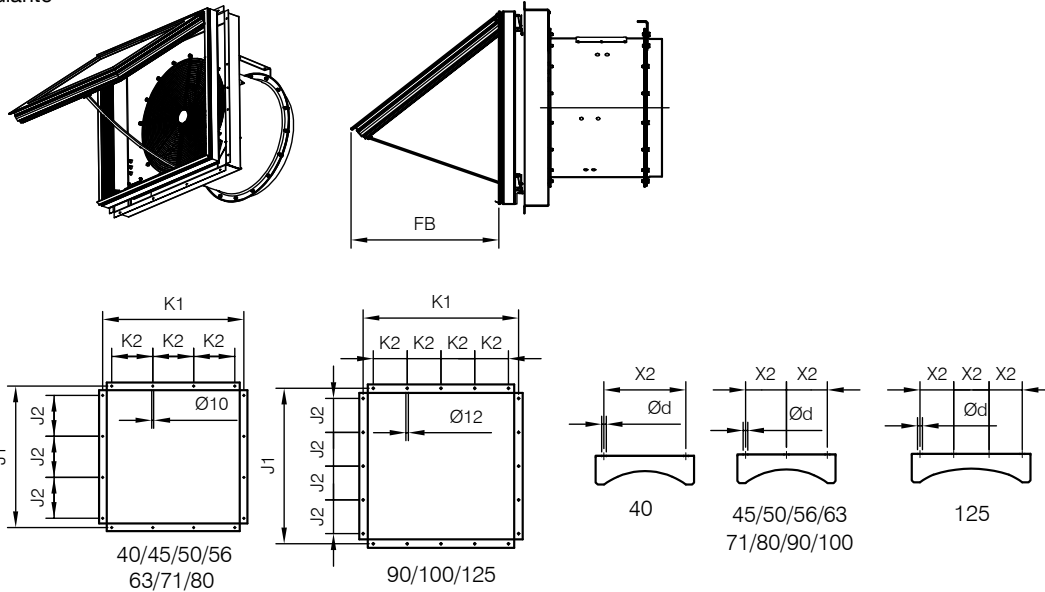

	A	B	C	D	ØD*	I	J	H	G	E	FA	FB	J1	J2	K1	K2	X2	ød
THT/WALL-40	640	590	650	600	400	80	255	530	510	82	460	460	740	200	740	200	200	10
THT/WALL-45	640	590	650	600	450	80	280	530	510	82	460	460	740	200	740	200	200	12
THT/WALL-50	690	690	700	700	500	80	305	530	510	82	551	551	830	220	830	220	200	12
THT/WALL-56	690	690	700	700	560	80	340	530	510	82	551	551	830	220	830	220	215	13
THT/WALL-56-2T-7.5	690	690	700	700	560	80	340	630	610	82	551	551	830	220	830	220	215	13
THT/WALL-63	990	990	1000	1000	630	80	385	630	605	82	875	875	1090	300	1090	300	215	13
THT/WALL-63-6T-1	990	990	1000	1000	630	80	385	530	505	82	875	875	1090	300	1090	300	215	13
THT/WALL-71	990	990	1000	1000	710	80	445	630	605	82	875	875	1090	300	1090	300	225	13
THT/WALL-80	990	990	1000	1000	800	100	490	630	605	82	875	875	1090	300	1090	300	280	13
THT/WALL-90	1190	1190	1200	1200	900	100	550	730	705	82	922	922	1310	250	1310	250	280	18
THT/WALL-90-4T-15	1190	1190	1200	1200	900	100	550	830	805	82	922	922	1310	250	1310	250	280	18
THT/WALL-100	1190	1190	1200	1200	1000	100	600	730	705	82	922	922	1310	250	1310	250	280	18
THT/WALL-100-4T-15	1190	1190	1200	1200	1000	100	600	830	805	82	922	922	1310	250	1310	250	280	18
THT/WALL-100-4T-20	1190	1190	1200	1200	1000	100	600	830	805	82	922	922	1310	250	1310	250	280	18
THT/WALL-125	1490	1490	1500	1500	1250	100	725	1050	1025	82	1176	955	1660	300	1660	300	300	18
THT/WALL-125-4T/6-20	1490	1490	1500	1500	1250	100	725	850	825	82	1176	955	1660	300	1660	300	300	18
THT/WALL-125-4T/6-50	1490	1490	1500	1500	1250	100	725	1150	1125	82	1176	955	1660	300	1660	300	300	18
THT/WALL-125-4T/9-50	1490	1490	1500	1500	1250	100	725	1150	1125	82	1176	955	1660	300	1660	300	300	18
THT/WALL-125-4T/12-50	1490	1490	1500	1500	1250	100	725	1150	1125	82	1176	955	1660	300	1660	300	300	18
THT/WALL-125-6T/6-5.5	1490	1490	1500	1500	1250	100	725	850	825	82	1176	955	1660	300	1660	300	300	18
THT/WALL-125-6T/6-7.5	1490	1490	1500	1500	1250	100	725	850	825	82	1176	955	1660	300	1660	300	300	18
THT/WALL-125-6T/6-10	1490	1490	1500	1500	1250	100	725	850	825	82	1176	955	1660	300	1660	300	300	18
THT/WALL-125-6T/6-15	1490	1490	1500	1500	1250	100	725	850	825	82	1176	955	1660	300	1660	300	300	18
THT/WALL-125-6T/9-10	1490	1490	1500	1500	1250	100	725	850	825	82	1176	955	1660	300	1660	300	300	18
THT/WALL-125-6T/9-15	1490	1490	1500	1500	1250	100	725	850	825	82	1176	955	1660	300	1660	300	300	18

\* Diámetro nominal tubería recomendada.  
 (C x D) Dimensión nominal de apertura de pared.  
 FA es la apertura cuando la compuerta es abatible.  
 FB es la apertura cuando la compuerta es basculante.

### Curvas características

Q= Caudal en m<sup>3</sup>/h, m<sup>3</sup>/s y cfm

Pe= Presión estática en mmH<sub>2</sub>O, Pa e inwg

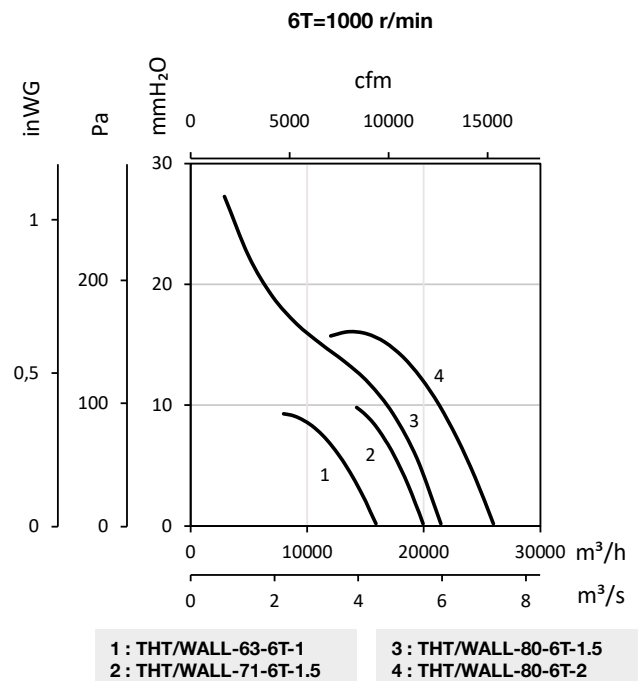
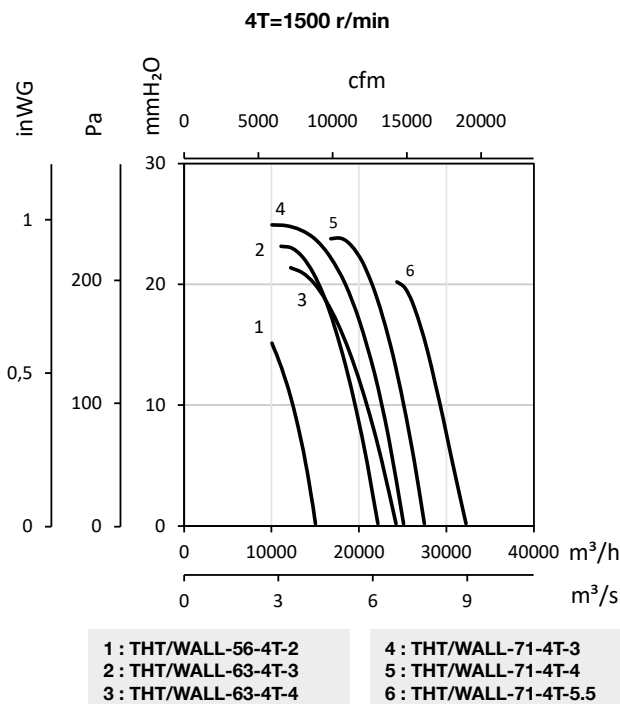
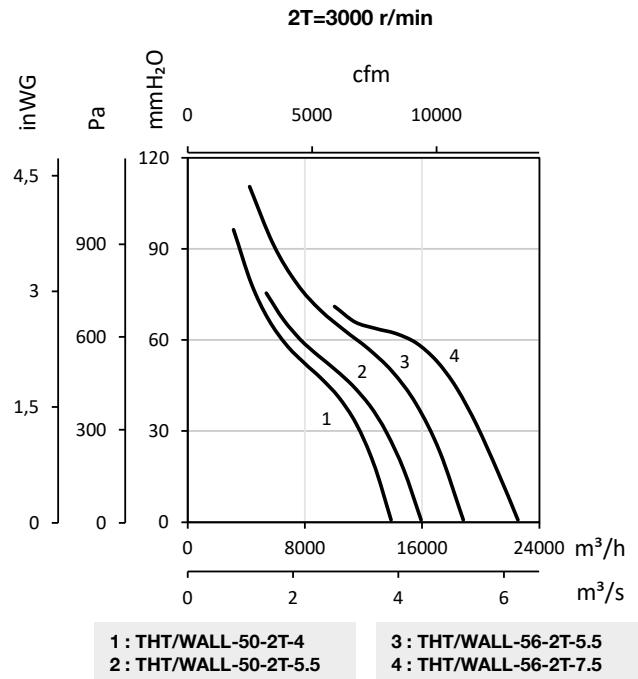
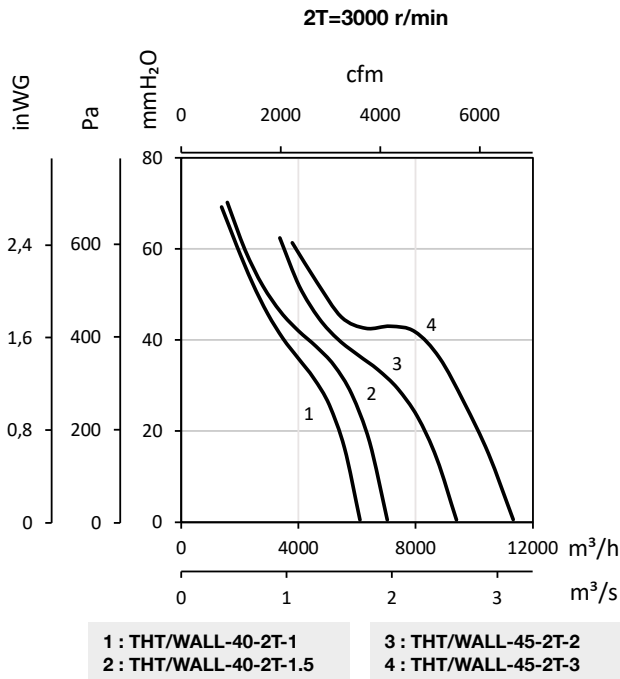

## Curvas características

Q= Caudal en m<sup>3</sup>/h, m<sup>3</sup>/s y cfm

Pe= Presión estática en mmH<sub>2</sub>O, Pa e inwg

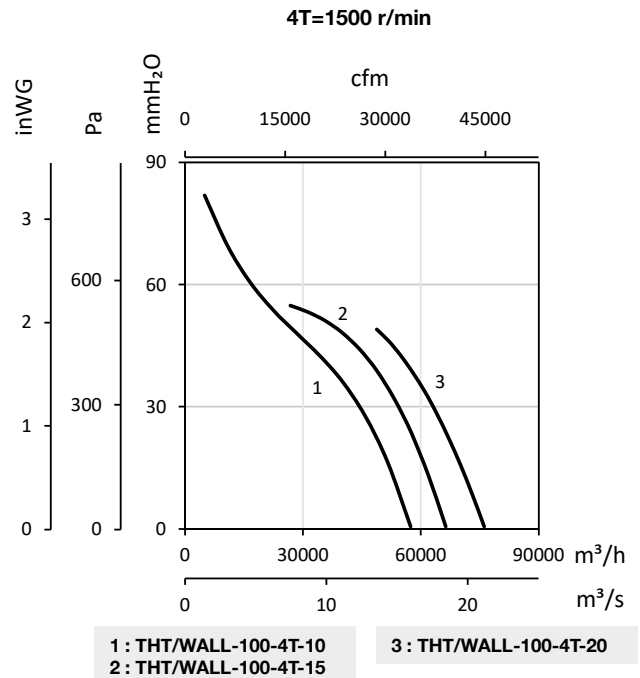
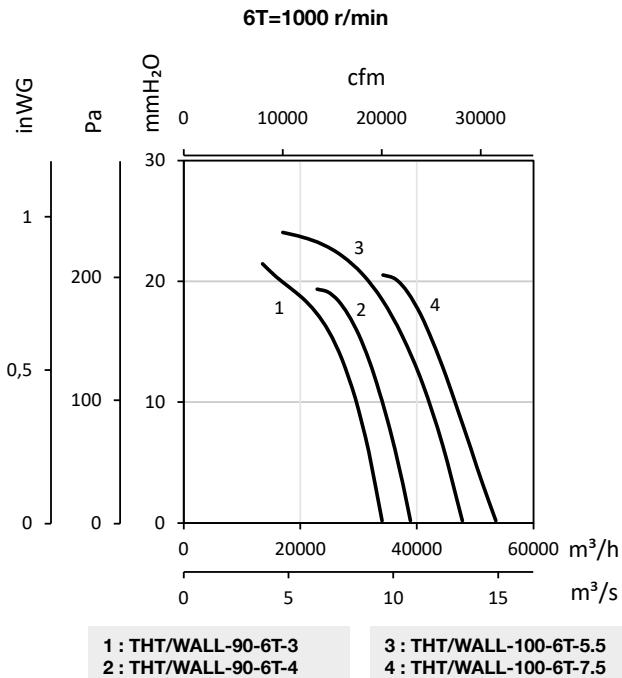
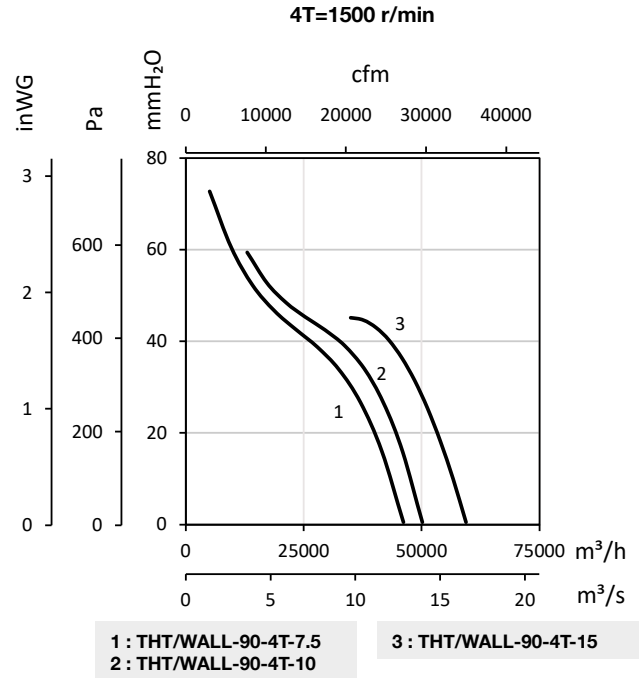
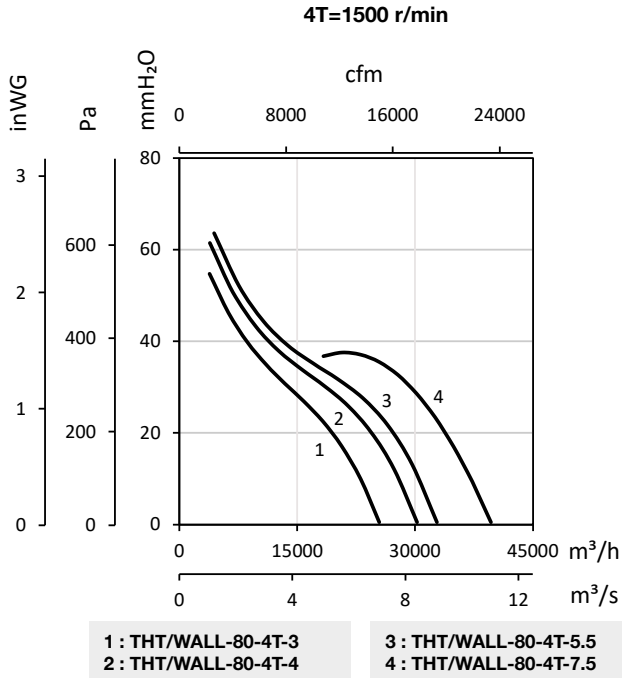

### Curvas características

Q= Caudal en m<sup>3</sup>/h, m<sup>3</sup>/s y cfm

Pe= Presión estática en mmH<sub>2</sub>O, Pa e inwg

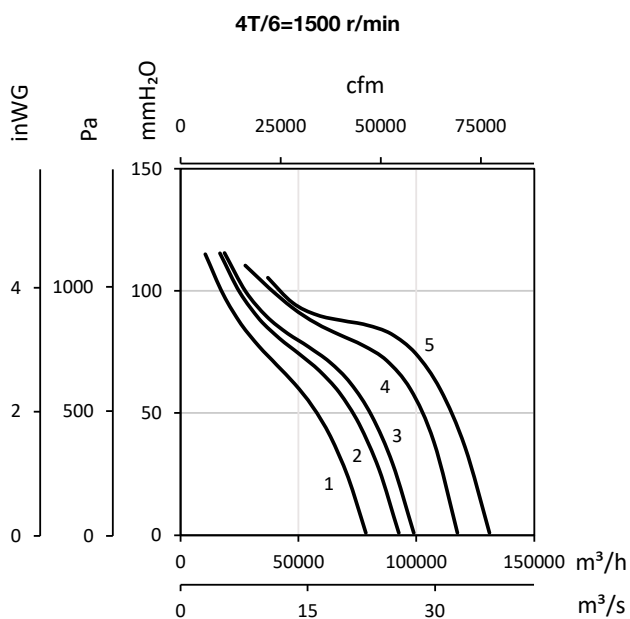

1 : THT/WALL-125-4T/6-20  
2 : THT/WALL-125-4T/6-25  
3 : THT/WALL-125-4T/6-30

4 : THT/WALL-125-4T/6-40  
5 : THT/WALL-125-4T/6-50

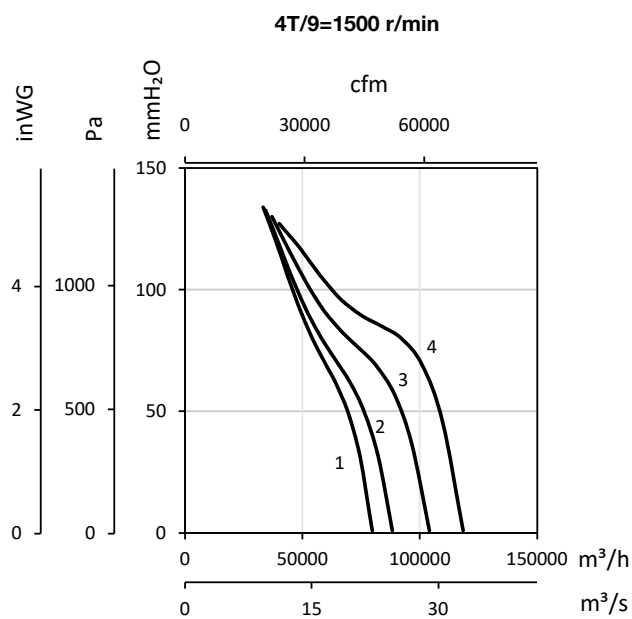

1 : THT/WALL-125-4T/9-25  
2 : THT/WALL-125-4T/9-30

3 : THT/WALL-125-4T/9-40  
4 : THT/WALL-125-4T/9-50

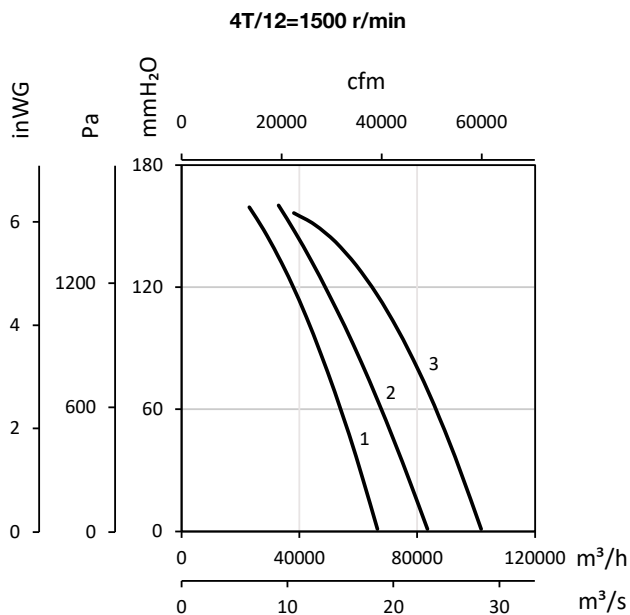

1 : THT/WALL-125-4T/12-30  
2 : THT/WALL-125-4T/12-40

3 : THT/WALL-125-4T/12-50

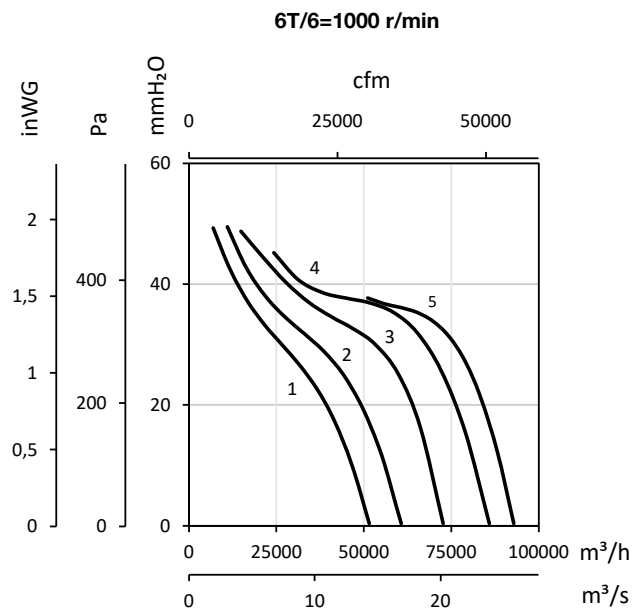

1 : THT/WALL-125-6T/6-5.5  
2 : THT/WALL-125-6T/6-7.5  
3 : THT/WALL-125-6T/6-10

4 : THT/WALL-125-6T/6-15  
5 : THT/WALL-125-6T/6-20

## Curvas características

Q= Caudal en m<sup>3</sup>/h, m<sup>3</sup>/s y cfm

Pe= Presión estática en mmH<sub>2</sub>O, Pa e inwg

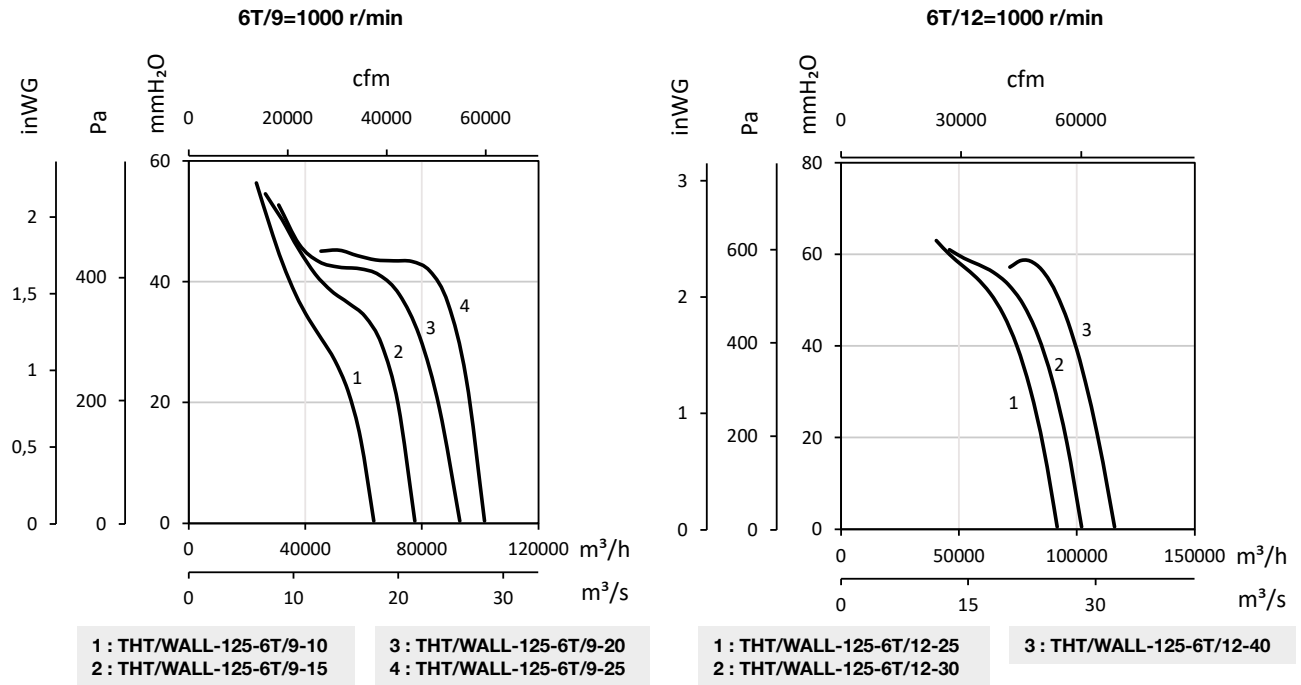

## Accesorios

