

CRF

- CON BAJO NIVEL SONORO
- MOTOR ROTOR EXTERNO
- REJILLA PROTECCIÓN ANTIPÁJAROS
- CUERPO ABATIBLE FÁCIL INSPECCIÓN

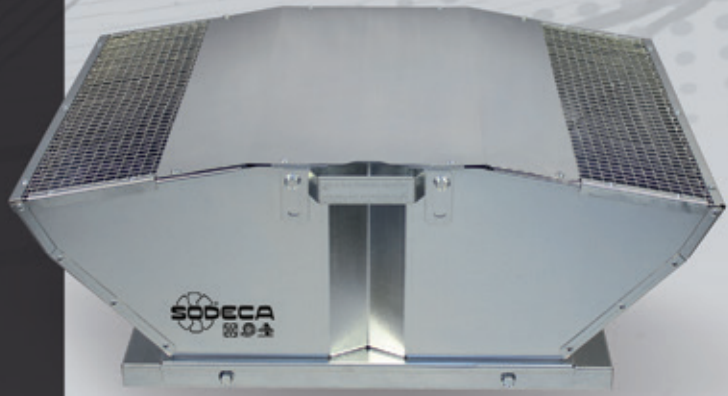

CRF/EW

- VENTILADOR DE ALTA EFICIENCIA
- MOTOR BRUSHLESS INDUSTRIAL E.C.
- POTENCIÓMETRO DE REGULACIÓN DE VELOCIDAD INCORPORADO
- CON BAJO NIVEL SONORO
- MOTOR ROTOR EXTERNO
- REJILLA PROTECCIÓN ANTIPÁJAROS
- CUERPO ABATIBLE FÁCIL INSPECCIÓN



EFFICIENT WORK

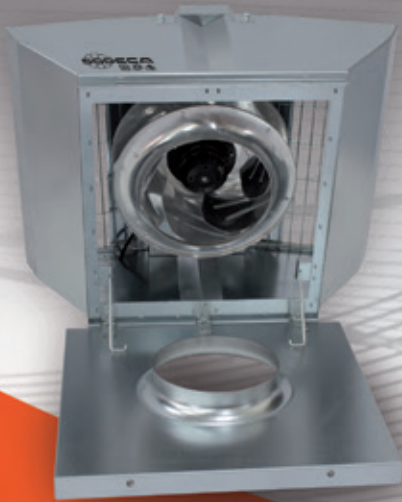
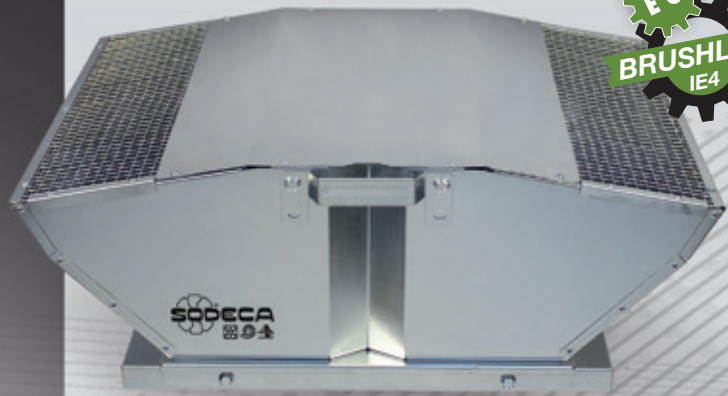

CRF CRF/EW

EXTRACTORES
CENTRÍFUGOS DE TEJADO



CRF



Extractores centrifugos de tejado, con bajo nivel sonoro

Extractores centrifugos de tejado, de bajo nivel sonoro, con motor de rotor exterior.



Ventilador:

- Construcción en chapa de acero galvanizado.
- Turbina con álabes a reacción, en chapa de aluminio excepto modelos 225 y 250 en chapa de acero.
- Rejilla de protección antipájaros.
- Cuerpo abatible para facilitar la inspección y el mantenimiento.

Motor:

- Motores clase F, de rotor exterior, protección IP54
- Monofásicos 230V.-50/60Hz, excepto modelos 450 y 500 230V.-50Hz
- Trifásicos 400V.-50/60Hz, excepto modelos 450 y 500 400V.-50Hz
- Temperatura máxima del aire a transportar: -25°C.+ 50°C.

Acabado:

- Anticorrosivo en chapa de acero galvanizado.

Bajo demanda:

- El variador electrónico de velocidad (VSD) se suministra bajo demanda

Código de pedido

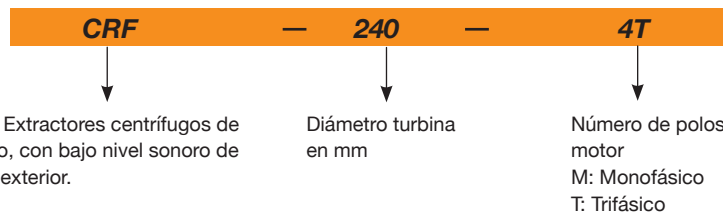

Características técnicas

Modelo	Velocidad (r/min)	Intensidad máxima admisible (A)		Potencia eléctrica máxima (kW)	Caudal máximo (m³/h)	Nivel presión sonora dB(A) ⁽¹⁾		Peso (Kg)	VSD Recomendado	ERP
		230V	400V			Aspiración	Descarga			
CRF-225-4M	1420	0,20		0,04	650	31	37	11	VSD1/M-0.5	2018
CRF-250-4M	1440	0,31		0,06	950	32	38	12	VSD1/M-0.5	2018
CRF-250-4T	1450		0,28	0,06	950	32	38	12	VSD3/A-RFT-1	2018
CRF-315-4M	1400	0,60		0,14	2000	39	45	17	VSD1/M-0.5	2018
CRF-315-4T	1430		0,35	0,14	2000	39	45	17	VSD3/A-RFT-1	2018
CRF-315-6M	940	0,38		0,08	1280	28	34	17	VSD1/M-0.5	2016
CRF-315-6T	900		0,20	0,07	1280	28	34	17	VSD3/A-RFT-1	2016
CRF-355-4M	1400	0,75		0,17	2500	43	48	24	VSD1/M-0.5	2018
CRF-355-4T	1400		0,45	0,18	2500	43	48	24	VSD3/A-RFT-1	2018
CRF-355-6M	930	0,46		0,10	1800	31	38	24	VSD1/M-0.5	2018
CRF-355-6T	950		0,32	0,10	1800	31	38	24	VSD3/A-RFT-1	2018
CRF-400-4M	1350	1,20		0,26	2810	46	52	28	VSD1/M-0.5	2018
CRF-400-4T	1380		0,60	0,27	2810	46	52	28	VSD3/A-RFT-1	2018
CRF-400-6M	940	0,72		0,14	2400	35	41	28	VSD1/M-0.5	2018
CRF-400-6T	900		0,40	0,15	2400	35	41	28	VSD3/A-RFT-1	2018
CRF-450-4M	1400	3,20		0,55	5400	53	59	42	VSD1/M-0.5	2018
CRF-450-4T	1340		1,00	0,55	5400	53	59	42	VSD3/A-RFT-1	2018
CRF-450-6M	930	1,30		0,26	3700	42	48	42	VSD1/M-0.5	2018
CRF-450-6T	920		1,00	0,30	3700	42	48	42	VSD3/A-RFT-1	2018
CRF-500-4T	1400		2,50	1,10	7600	57	62	51	VSD3/A-RFT-2	2018
CRF-500-6M	920	1,80		0,40	5200	45	52	51	VSD1/M-0.5	2018
CRF-500-6T	950		1,25	0,45	5200	45	52	51	VSD3/A-RFT-1	2018

(1) Los valores de los niveles sonoros, son presiones en db(A), medidos a 6 metros, y a 2/3 del caudal máximo (2/3 Qmáx.)

Características acústicas

Espectro de potencia sonora Lw(A) en dB(A) por banda de frecuencia en Hz.

Valores tomados a la aspiración con 2/3 caudal máximo (2/3Qmax).

Modelo	63	125	250	500	1000	2000	4000	8000
225	29	35	46	49	50	46	44	38
250	30	36	47	50	51	47	45	39
315-4	40	49	54	54	58	57	50	44
315-6	29	38	43	43	47	46	39	33
355-4	44	53	58	58	62	61	54	48
355-6	32	41	46	46	50	49	42	36
400-4	48	54	60	60	63	66	57	51
400-6	37	43	49	49	52	55	46	40
450-4	55	61	67	67	70	73	64	58
450-6	44	50	56	56	59	62	53	47
500-4	60	67	72	72	76	75	68	63
500-6	48	55	60	60	64	63	56	51

Valores tomados a la descarga con 2/3 caudal máximo (2/3Qmax).

Modelo	63	125	250	500	1000	2000	4000	8000
225	33	38	52	54	55	55	50	45
250	34	39	53	55	56	56	51	46
315-4	39	48	58	62	65	62	55	49
315-6	28	37	47	51	54	51	44	38
355-4	42	51	61	65	68	65	58	52
355-6	32	41	51	55	58	55	48	42
400-4	47	59	67	69	70	70	62	54
400-6	36	48	56	58	59	59	51	43
450-4	54	66	74	76	77	77	69	61
450-6	43	55	63	65	66	66	58	50
500-4	58	70	78	80	81	78	71	63
500-6	48	60	68	70	71	68	61	53

Para obtener los espectros de potencia sonora Lwa en dB(A) en la aspiración a caudal máximo (Qmax), sumar al nivel de presión sonora LpA dado en las curvas características, los valores de la tabla siguiente:

Banda de frecuencia en Hz								
63	125	250	500	1000	2000	4000	8000	
2	9	15	15	18	18	11	5	

Dimensiones mm

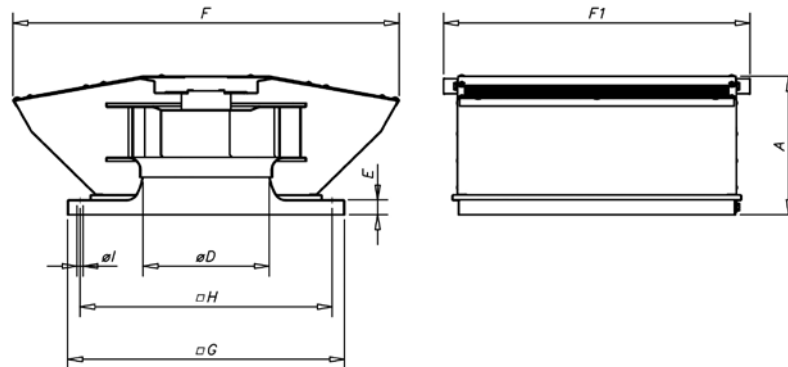

Modelo	A	ØD*	E	F	F1	G	H	øI
CRF-225	185	200	30	475	420	355	305	12
CRF-250	185	250	30	515	460	400	350	12
CRF-315	265	250	30	690	510	450	400	12
CRF-355	280	355	30	780	620	560	510	12
CRF-400	280	355	30	780	620	560	510	12
CRF-450	400	500	30	1110	775	710	660	12
CRF-500	400	500	30	1110	775	710	660	12

(*) Diámetro nominal tubería recomendada

Curvas características

Q= Caudal en m³/h, m³/s y cfm.

Pe= Presión estática en mmH₂O, Pa e inwg.

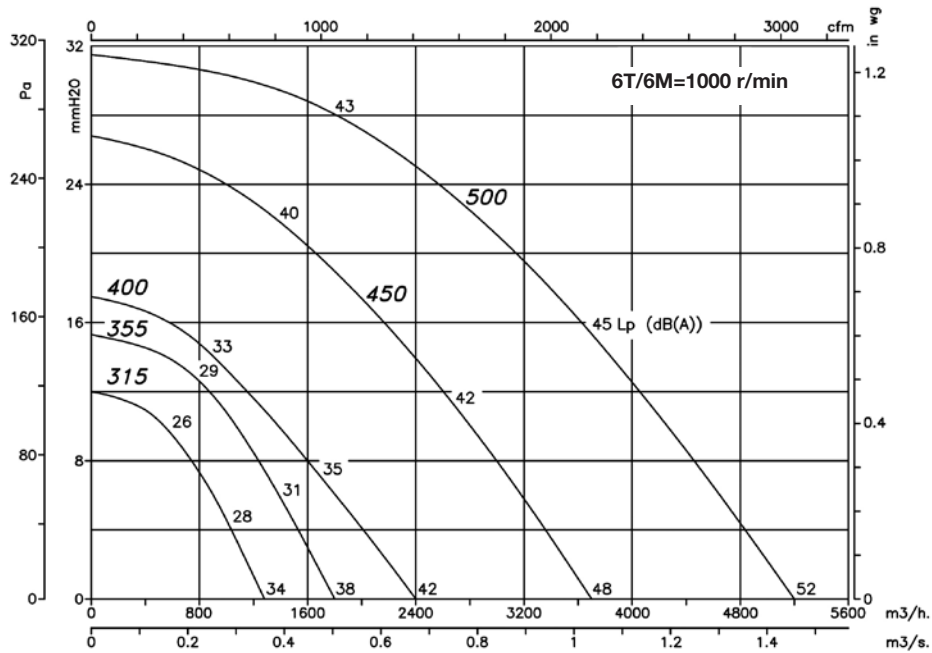
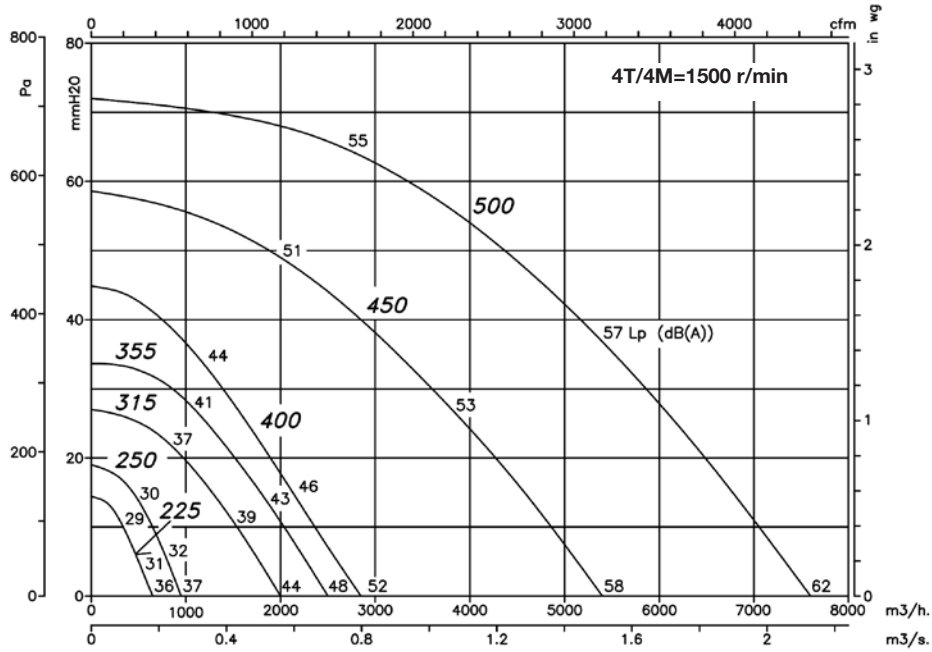

Los niveles sonoros Lp (dB(A)) indicados en las curvas, son presiones medidas a 6 metros, a la aspiración y en campo libre

Accesorios



CRF/EW



MOTOR BRUSHLESS CON VSD INTEGRADO



Extractores centrífugos de tejado, con bajo nivel sonoro, equipados con motor de rotor exterior Brushless E.C.

Extractores centrífugos de tejado, de bajo nivel sonoro, con motor de rotor exterior, equipados con motor Brushless E.C y potenciómetro de regulación de velocidad incorporado

Ventilador:

- Construcción en chapa de acero galvanizado.
- Turbina con álabes a reacción construida en material plástico.
- Rejilla de protección antipájaros.
- Cuerpo abatible para facilitar la inspección y el mantenimiento

Motor:

- Motores EC de rotor exterior, de alta eficiencia y regulables mediante señal 0-10V. Protección IP54.
- Monofásicos 230V.-50/60Hz., y trifásicos 400V.-50/60Hz
- Temperatura máxima del aire a transportar: -25°C.+ 50°C.

Acabado:

- Anticorrosivo en chapa de acero galvanizado.

Código de pedido

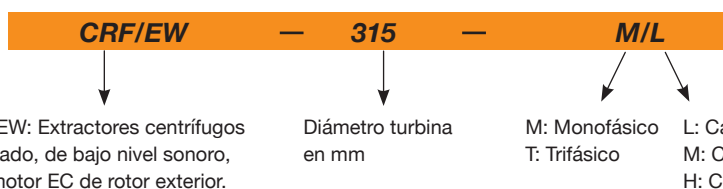

Características técnicas

Modelo	Velocidad máxima (r/min)	Intensidad máxima admisible (A)		Potencia eléctrica máxima (kW)	Caudal máximo (m³/h)	NPS a Velocidad máxima (dBA) ⁽¹⁾		Peso aprox. (Kg)	ERP
		230V	400V			Aspiración	Descarga		
CRF/EW-190-M	3200	0,75		0,083	695	42	45	10	2018
CRF/EW-250-M	2510	1,40		0,170	1305	44	47	12	2018
CRF/EW-315-M/L	1524	1,20		0,150	2170	35	38	16	2018
CRF/EW-315-M/H	2360	2,20		0,500	3365	49	52	18	2018
CRF/EW-400-M/L	1170	1,10		0,250	4020	39	42	26	2018
CRF/EW-400-M/M	1500	2,20		0,500	5285	45	48	27	2018
CRF/EW-400-M/H	1700	3,30		0,750	5830	49	52	28	2018
CRF/EW-400-T	2060		2,10	1,320	6330	51	58	29	2018
CRF/EW-500-M	1100	3,30		0,750	7950	43	49	48	2018
CRF/EW-500-T/L	1350		2,10	1,320	9560	48	54	50	2018
CRF/EW-500-T/H	1700		4,00	2,650	10625	53	60	59	2018

(1) Los valores de los niveles sonoros, son presiones en dB(A), medidos a 6 metros, y a 2/3 del caudal máximo (2/3 Qmax.)

Características acústicas

Espectro de potencia sonora Lw(A) en dB(A) por banda de frecuencia en Hz.

Valores tomados a la aspiración con 2/3 caudal máximo (2/3Qmax).

Modelo	63	125	250	500	1000	2000	4000	8000
190-M	28	45	51	58	60	61	57	52
250-M	34	49	55	60	62	61	59	50
315-M/L	29	51	48	53	53	51	47	40
315-M/H	46	61	63	66	65	66	61	55
400-M/L	35	55	52	57	55	53	51	53
400-M/M	46	60	57	63	61	59	54	57
400-M/H	39	63	62	68	65	63	58	60
400-T	40	53	65	71	68	68	63	63
500-M	41	55	56	60	62	61	57	50
500-T/L	45	57	60	65	65	65	62	56
500-T/H	50	63	66	70	71	71	68	62
560-T/L	50	67	71	73	72	69	66	66
560-T/H	54	71	75	76	76	72	70	69
630-T/L	57	68	73	71	74	71	67	61
630-T/H	50	70	76	77	83	82	78	75

Valores tomados a la descarga con 2/3 caudal máximo (2/3Qmax).

Modelo	63	125	250	500	1000	2000	4000	8000
190-M	31	48	54	61	63	64	60	55
250-M	37	52	58	63	65	64	62	53
315-M/L	32	54	51	56	56	54	50	43
315-M/H	49	64	66	69	68	69	64	58
400-M/L	38	58	55	60	58	56	54	56
400-M/M	49	63	60	66	64	62	57	60
400-M/H	42	66	65	71	68	66	61	63
400-T	45	56	68	73	78	76	70	66
500-M	43	56	59	67	69	65	59	53
500-T/L	46	59	63	71	75	69	65	59
500-T/H	52	65	69	77	81	75	71	65
560-T/L	53	66	70	75	80	73	69	65
560-T/H	57	70	73	79	83	77	72	68
630-T/L	60	71	75	80	81	75	70	64
630-T/H	57	80	88	86	90	87	82	77

Dimensiones mm

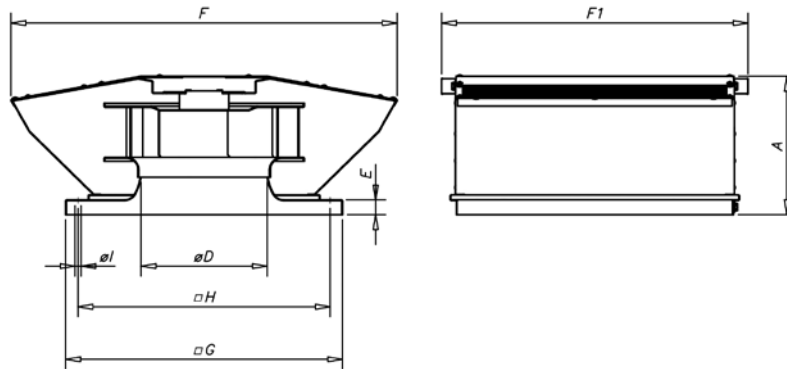

Modelo	A	ØD*	E	F	F1	G	H	øI
CRF/EW-190	185	200	30	475	420	355	305	12
CRF/EW-250	185	250	30	515	460	400	350	12
CRF/EW-315	265	250	30	690	510	450	400	12
CRF/EW-400	280	355	30	780	620	560	510	12
CRF/EW-500	400	500	30	1110	775	710	660	12

(*) Diámetro nominal tubería recomendada

Curvas características y datos ErP

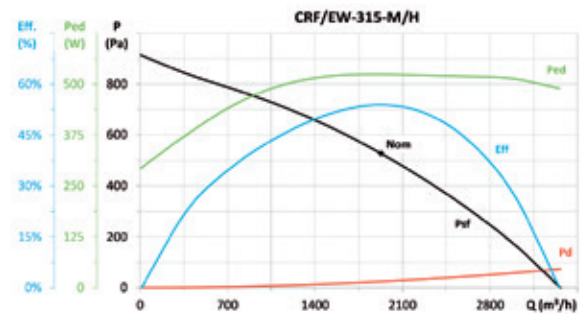
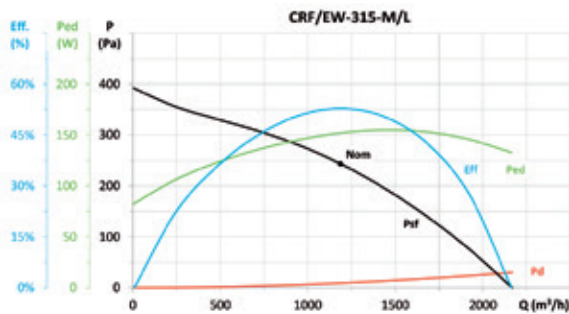
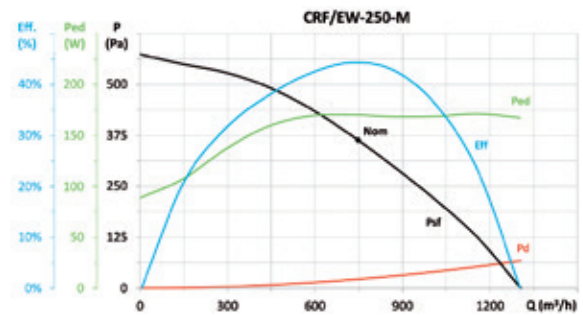
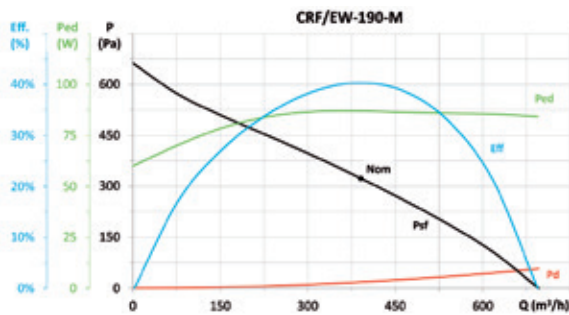

Curvas características y datos ErP

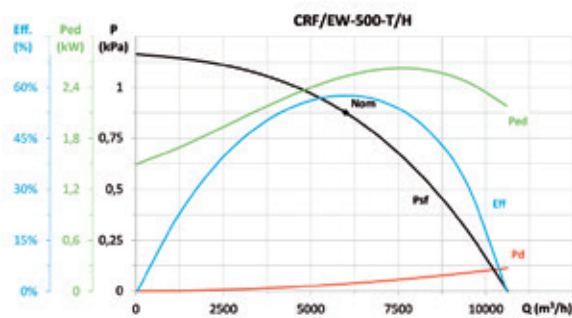
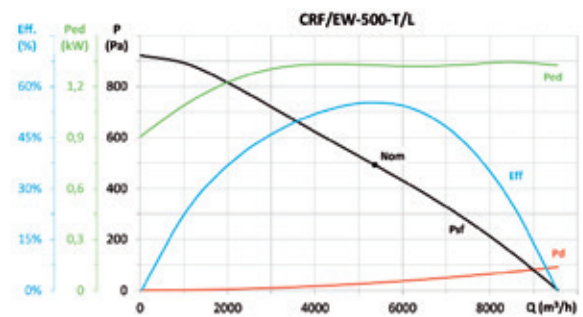
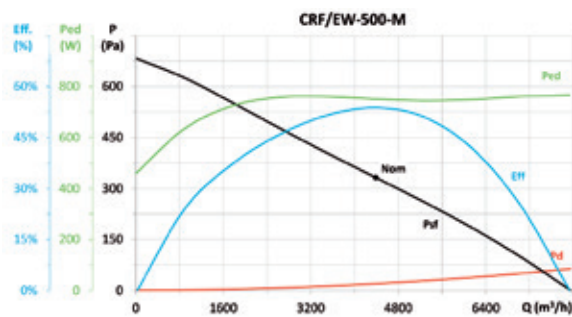
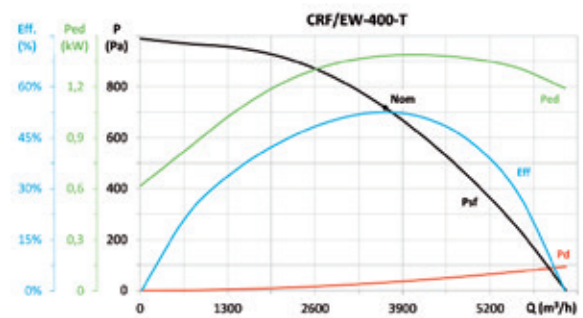
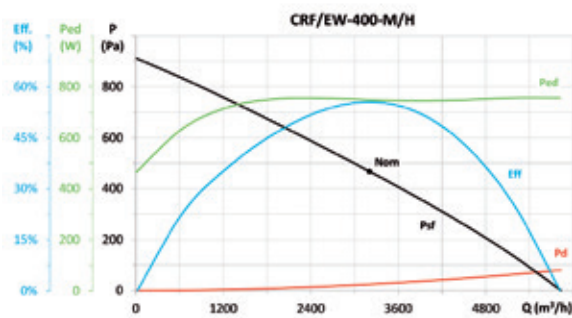
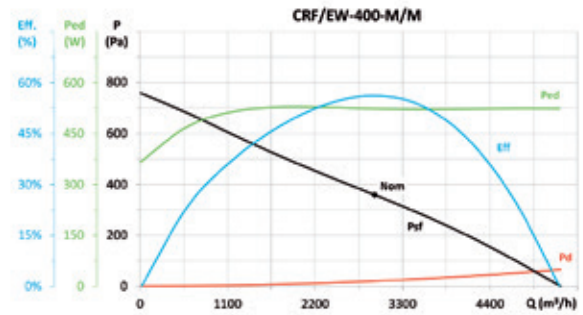
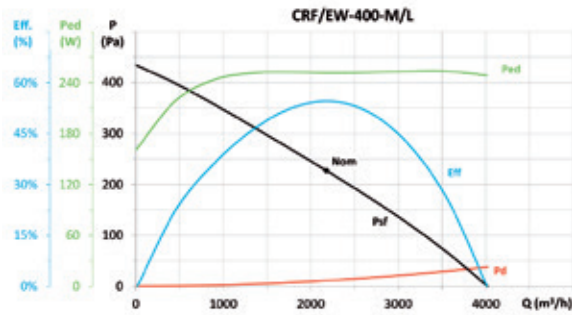

Accesorios

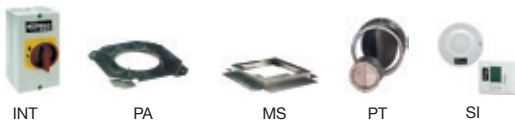

EFFICIENT WORK FANS



SOLution DEvelopment CAPacity

Fast and flexible industrial fan solutions and tailored fans

Large experience in smoke control systems and ATEX applications

Wide range of certified products for specific markets

VENTILADORES
HELICOIDALES Y
EXTRACTORES DE TEJADO



VENTILADORES
CENTRÍFUGOS Y EXTRACTORES
EN LÍNEA



EXTRACTORES
PARA EVACUACIÓN
DE HUMOS



VENTILADORES HEAVY DUTY
Y EXTRACTORES PARA
ATMÓSFERAS EXPLOSIVAS ATEX



RECUPERADORES DE CALOR,
UNIDADES DE FILTRACIÓN
Y TRATAMIENTO DE AIRE



CORTINAS DE AIRE PARA
APLICACIONES COMERCIALES E
INDUSTRIALES



SISTEMAS DE VENTILACIÓN PARA
VIVIENDAS



SOLICÍTENOS INFORMACIÓN

www.sodeca.com



SODECA Group



HEADQUARTER
Sodeca S.L.U.
Ctra. de Berga, km 0,7
E-08580 SANT QUIRZE DE
BESORA
Barcelona, SPAIN
Tel. +34 93 852 91 11
Fax +34 93 852 90 42
General sales:
comercial@sodeca.com
Export sales:
ventilation@sodeca.com

CHILE
Sodeca Ventiladores Ltda
Sr. Frederic Cousquer
Santa Bernardita 12.005
(Esquina con Puerta Sur)
Bodegas 24 a 26
03380 San Bernardo,
Santiago, CHILE
Tel. +56 22 840 5582
ventas.chile@sodeca.com

COLOMBIA
Sodeca Colombia S.A.S
Sra. Luisa Stella Prieto
Avenida 1 de Mayo
N°72N - 45/47 Sur
Bogotá, COLOMBIA
Tel. +57 1 293 7272
ventascolombia@sodeca.co

PORTUGAL
Sodeca Portugal Lda
PORTO
Rua Veloso Salgado 1120/1138
4450-801 Leça de Palmeira,
Tel. +351 229 991 100
Fax. +351 229 991 119
geral@sodeca.pt

FINLAND
Sodeca Finland Oy
Mr. Kai Yli-Sipilä
Metsälinnankatu 30, PL2,
FI-32700 Huittinen,
FINLAND
Tel. +358 400 320 125
orders.finland@sodeca.com

PORTUGAL
Sodeca Portugal Lda
LISBOA
Parque Empresarial da Granja
Pavilhão 8
2625-607 Vialonga,
Tel. +351 219 748 491
Fax. +351 219 748 493
geral@sodeca.pt

RUSSIA
Sodeca, L.L.C.
Mr. Stanislav Alifanov
Myasisheva str, 1, room 603
Business Center "Chaika"
140180 Zhukovskiy,
Moscow, RUSSIA
Tel. +7 495 955 90 50
alifanov@sodeca.com

UNITED KINGDOM
Sodeca Fans UK Ltd
Mr. Mark Newcombe
Pacific House
Relay Point
Tamworth, B77 5PA
UNITED KINGDOM
Tel. +44 (0) 1827 264 435
Mob. +44 (0) 7488 517433
sales@sodeca.co.uk

ZONA CARIBE
Sodeca Cuba
Sr. Carlos Hernández
Residencial Miramar
Apto. N° 108
Ave. 7ma N° 1805 entre 18 y 20
Miramar Playa, Havana, CUBA
Tel. +537 20 43721
carlos@sodeca.co.cu