



APLICACIONES PARA:



APLICACIONES INDUSTRIALES



ATMÓSFERAS EXPLOSIVAS ATEX



CONSTRUCCIONES NAVALES



OFF-SHORE



INDUSTRIA QUÍMICA

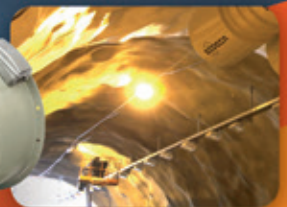

MINERÍA Y OBRAS PÚBLICAS

# VENTILADORES **HEAVY DUTY** PARA APLICACIONES INDUSTRIALES Y EXTRACTORES PARA **ATMÓSFERAS EXPLOSIVAS ATEX**



ATEX 94/9/CE

CALIDAD ACABADO  
C3H, C4H, C5M





## NUESTRO COMPROMISO CON EL MEDIO AMBIENTE

Sodeca ha iniciado una nueva etapa de estudio y diseño de nuevas tendencias de ventilación que ayuden a la preservación del medio ambiente y al ahorro energético que tanto preocupa a la sociedad actual.



### EFFICIENT WORK

SODECA presenta los nuevos ventiladores eficientes **"Efficient Work"** de alto rendimiento, equipados con motorizaciones de alta tecnología para lograr un ahorro energético superior. Estos nuevos productos sobrepasan los requisitos de la directiva Ecodesing ErP 2009/125/CE y su reglamentación (EU) 327/2011 para ventiladores, colaborando con el objetivo KIOTO adoptado por la UE para la reducción de emisiones de CO<sup>2</sup>.

**SODECA** centra su actividad en la producción de ventiladores industriales, sistemas de ventilación y extractores para la evacuación de humos en caso de incendio, desde 1983 año de su fundación.

Los ventiladores y extractores de **SODECA** están presentes en todos los países Europeos y en gran parte del mundo, gracias a la calidad del producto y a los métodos de investigación y desarrollo utilizados.

Nuestros procedimientos de calidad utilizados y certificados por BUREAU VERITAS, según ISO 9001:2008, son otra de las razones que sitúan a **SODECA** como uno de los mejores y más reconocidos fabricantes de ventiladores de Europa.

Sin duda el factor más importante para alcanzar nuestros objetivos, es el factor humano, grandes profesionales que trabajan a su servicio, ofreciendo no sólo equipos de ventilación, sino soluciones a cualquier necesidad de ventilación planteada por nuestros clientes.

Les ofrecemos la posibilidad de visitar nuestras instalaciones en Sant Quirze de Besora, con más de 16.000 m<sup>2</sup> de superficie construida, donde podrá ver nuestra fabricación de ventiladores, con las más altas exigencias de calidad, cumpliendo con las normativas de ISO y AMCA.

Este catálogo es solo un pequeño detalle de nuestras posibilidades, no dude en contactar con nosotros, ponemos toda nuestra experiencia y nuestro equipo humano a su disposición.



Instalaciones centrales de SODECA S.L.U., en Sant Quirze de Besora



# ATMÓSFERAS EXPLOSIVAS ATEX

Todos los extractores y ventiladores SODECA para atmósferas explosivas cumplen con las exigencias de la directiva europea ATEX 94/9/CE y han estado diseñados de acuerdo a la norma EN-14986 "Diseño de ventiladores para trabajar en atmósferas potencialmente explosivas". De esta forma se garantiza la calidad de los productos y se asegura al máximo la seguridad de las personas e instalaciones.

## CERTIFICADOS ATMÓSFERAS EXPLOSIVAS ATEX



EAC

### Diseño de los ventiladores:

De acuerdo a la norma EN-14986 y para evitar la ignición en el caso de fricción o impacto entre la parte móvil y la estática, se fabrican con materiales combinables entre sí para prevenir posibles chispas.

#### Ventiladores centrífugos:

##### Para prevenir chispas generadas por la turbina:

- . Boca de aspiración de cobre
- . Casquillos de protección para proteger las uniones atornilladas/remachadas
- . Verificación de las distancias entre componentes

#### Ventiladores helicoidales:

##### - Para prevenir chispas generadas por la hélice:

- . Banda de recubrimiento de cobre o aluminio sobre la cara interior del aro
- . Verificación de las distancias entre componentes

Siguiendo la normativa, todas las partes del ventilador que no están soldadas entre sí, y están fijadas mecánicamente mediante otros sistemas, o son diferentes piezas recubiertas de pintura que pueden aislar la conductividad, están unidas mediante tomas de tierra, para evitar las diferencias de potencial entre estas partes no soldadas o pintadas.

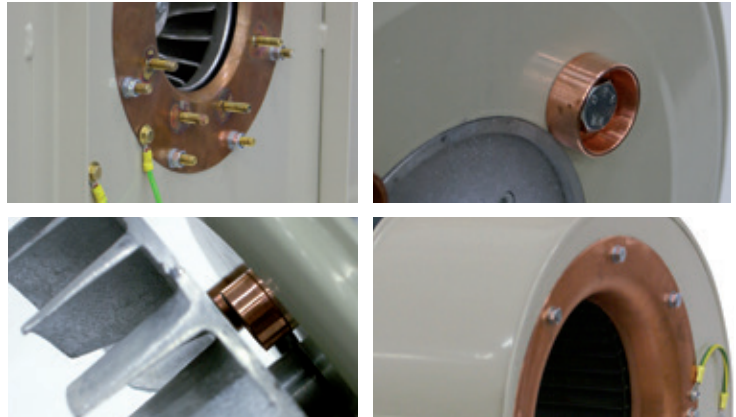

Sodeca se ha especializado desde sus orígenes en el diseño y la fabricación de ventiladores y sus accesorios para aplicaciones industriales.

La unión de la experiencia adquirida durante décadas de trabajo con ventiladores, junto con la tecnología aportada por ingenieros distribuidos en diferentes departamentos, ha permitido que Sodeca se sitúe entre los mayores fabricantes de ventilación industrial del mundo.

Las aplicaciones industriales requieren gran capacidad de adaptación a las especificaciones de cada proyecto y flexibilidad en la fabricación, para cumplir con las necesidades reales de cada cliente.

Para cumplir con este objetivo Sodeca dispone de una línea de productos Standard y una línea de productos de fabricación especial, para la construcción de ventiladores adaptados a las exigencias de nuestros clientes.

Para los diferentes proyectos podemos utilizar motores que cumplen las normativas más exigentes del mercado:

NEMA super premium efficiency

NEMA premium efficiency

NEMA high efficiency

U.L. motors

C.S.A. motors

## Extractores para **ATMÓSFERAS EXPLOSIVAS ATEX**

Una zona ATEX es una mezcla de aire con **gas** inflamable, **vapor** de líquido inflamable, **niebla** de líquido combustible o **polvo** combustible, que de inflamarse lo hacen en todo su conjunto a la vez.



### Sensibilidad a la inflamación de los gases:

<b>LIE</b>	Límite inferior de explosividad » % volumen.
<b>LSE</b>	Límite superior de explosividad » % volumen.
<b>EMI</b>	Energía mínima de Inflamación » 10-6 μ Joules
<b>Flash Point</b>	Temperatura mínima de un líquido forma gases inflamables
<b>Temperatura de Ignición</b>	Temperatura a la que inflama un gas (T1, T2, T3, T4, T5 y T6)

### Sensibilidad a la inflamación de sólidos:

<b>LIE ó CME</b>	Concentración mínima explosiva » g/m <sup>3</sup>
<b>CLO</b>	Concentración límite de Oxígeno » % volumen
<b>EMI</b>	Energía mínima de Inflamación » 10-3 μ Joules
<b>TMI</b>	Temperatura mínima de inflamación en °C: - En nube TMI n (nube de polvo en contacto con una superficie caliente). - En capa TMI c ignición de una capa de 5 mm. - (límite de T el menor de: 2/3 de TMI n o TMI c -75°C)

### Resumen de definiciones de las zonas

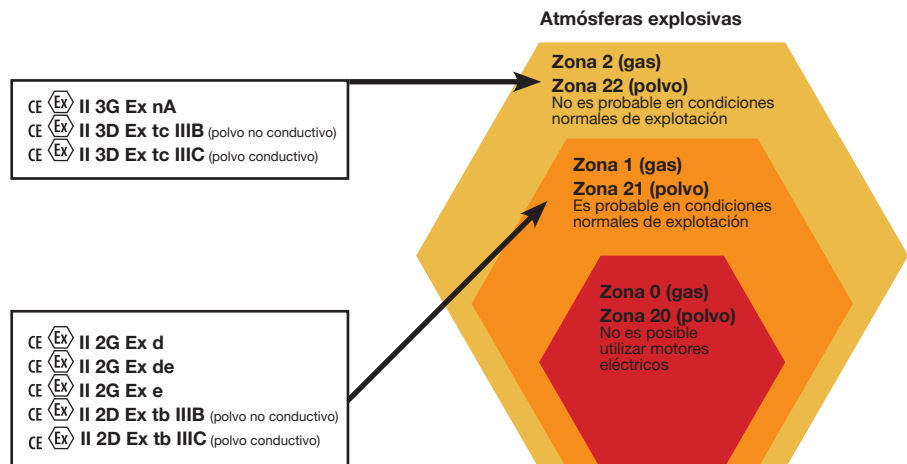

#### Definición de zonas:

Gases y vapores / Polvos:

- **Zona 0 / Zona 20:**  
Presente continuamente, durante largos periodos de tiempo o frecuentemente. No es posible utilizar motores eléctricos.
- **Zona 1 / Zona 21:**  
Es probable en condiciones normales de funcionamiento
- **Zona 2 / Zona 22:**  
No es probable la creación de zona ATEX en condiciones de funcionamiento normal

#### Grupos y categorías de aparatos:

**GRUPO I: equipos para trabajos subterráneos y de superficie de minas con peligro por grisú o polvos explosivos.**

- Categoría M1: deben permanecer operativos
- Categoría M2: se debe poder cortar la alimentación de energía

**GRUPO II: Otras zonas de riesgo**

- Categoría 1: nivel de protección muy alto. Zona muy probable.
- Categoría 2: nivel de protección alto. Zona probable.
- Categoría 3: nivel de protección normal. Zona poco probable.

### Selección de la categoría en función de la zona:

ZONA	CATEGORÍA
0 o 20	1
1 o 21	1 o 2
2 o 22	1, 2 o 3

### Selección de zona en función de la categoría:

CATEGORÍA	ZONA
1	Todas
2	1, 21, 2 o 22
3	2 o 22

### Grupo de explosión y clase de temperatura

Grupo de explosión	Clase de temperatura					
	T1	T2	T3	T4	T5	T6
<b>II A</b>	Acetona Etano Acetato etílico Cloruro de etilo Amoníaco Benceno Ácido acético	Óxido de carbono Metano Metanol Cloruro de metilo Propano Gas ciudad Tolueno	Acetato amílico-i Butano Alcohol butílico-n Ciclo-hexano Dicloroetano 1, 2 Anhídrido acético	Gasolina Carburantes Otto Carburante aviación Aceites combustib. Hexano	Acetal-dehido	
<b>II B</b>		Alcohol etílico Etileno Óxido de etileno	Hidrógeno sufarado	Eter etílico		
<b>II C</b>	Hidrógeno	Acetileno				Sulfuro de carbono

### Clase de temperatura y temperatura de ignición:

Clase de temperatura	Temperatura de ignición
T1	>450°C
T2	>300°C
T3	>200°C
T4	>135°C
T5	>100°C
T6	>85°C

### Valores de explosividad de sólidos combustibles

Producto	Kmax	Pmax	EMI	CLO	TMIn	TIMc
Harina de maíz	127	6.7	300	--	530	460
Harina de arroz	40	6.7	>10	--	370	480
Harina de trigo	47	8.2	>300	11%	460	470
Harina de Malta	100	7.8	>10	11%	310	460
Almidón de maíz	143	10.6	>100	9%	440	400
Almidón de arroz	220	10.0	>10	--	470	390
Almidón de patata	89	9.4	>3000	--	520	570

### Marcado según ATEX

Marcado de motores de acuerdo con la directiva ATEX

CE	0081	Ex	II	2	G/D
Marcado CE	Identificación del organismo certificador (Ej. LCIE)	Marcado CE para los productos Ex	Agrupamiento de aparatos eléctricos	Categoría del equipo (2 ó 3)	Gas o Polvo



### Marcado según EN

Marcado estándar adicional para motores

Ex	d	II	C	T4	Gb
Aparato protegido contra explosiones	Tipo de protección	Grupos (todos excepto minas)	Grupos según Gas (necesario sólo para antideflagrantes)	Clase de temperatura	Nivel de protección contra explosión



### Valores de explosividad de gases combustibles

	Grupo de gas	%vol LIE	g/mol M		Grupo de gas	%vol LIE	g/mol M
metano	I	5,0	16,04	cloroetano	IIA	3,6	64,51
acetato de amilo	IIA	1,1	130,19	cloroetano	IIIA	5,0	106,97
acetato de butilo	IIA	1,2	116,16	cloroetileno(cloruro de vinilo)	IIA	3,8	62,50
acetato de etilo	IIA	2,1	88,11	clorometano	IIA	7,6	50,49
acetato de metilo	IIA	3,1	74,08	cloropropano	IIA	2,6	78,54
acetato de propilo	IIA	1,7	102,13	cloruro de acetilo	IIA	5,0	78,50
acetona	IIA	2,2	55,06	cloruro de alilo	IIA	3,3	76,53
acetonitrilo	IIA	3,0	41,05	creso	IIIA	1,0	108,14
ácido acético	IIA	4,0	60,05	decahidronaftaleno(decalina)	IIA	0,7	138,25
aldehído acético	IIA	4,0	44,05	decano	IIA	0,81	42,28
amoníaco	IIA	15,0	17,03	diacetona-alcoho	IIIA	1,8	116,16
anilina	IIA	1,2	107,13	dicloroetano	IIA	5,6	98,96
benceno	IIA	1,2	78,11	dicloroetileno	IIA	6,5	96,94
bromobutano	IIA	2,6	137,02	dicloropropano	IIA	3,4	112,99
bromoetano	IIA	6,7	108,97	dietilamina	IIA	1,7	73,14
butano	IIA	1,5	58,12	dimetilamina	IIA	2,8	45,08
butano	IIIA	1,4	74,12	dimetilnilina	IIA	1,2	121,18
butil metil cetona	IIA	1,2	100,16	dipropiléter	IIA		102,18
butilamina	IIA	1,7	73,14	estireno	IIA	1,1	104,15
ciclobutano	IIA	1,8	56,11	etano	IIA	3,0	30,07
ciclohexano	IIA	1,2	84,16	etano	IIIA	3,3	46,07
ciclohexano	IIIA	1,2	100,16	etil metil cetona	IIA	1,8	72,11
ciclohexanona	IIA	1,3	98,14	etilbenceno	IIA	1,0	106,17
ciclopentano	IIA	1,1	70,13	etilmercaptano	IIA	2,8	62,13
clorobenceno	IIA	1,1	112,56	feno	IIIA	1,3	94,11
clorobutano	IIA	1,8	92,57	formiato de etilo	IIA	2,7	74,08



**APLICACIONES INDUSTRIALES**



**APLICACIONES ATMÓSFERAS EXPLOSIVAS ATEX**



**APLICACIONES NAVALES**

## Valores de explosividad de gases combustibles

	Grupo de gas	%vol LIE	g/mol M		Grupo de gas	%vol LIE	g/mol M
formiato de metilo	IIA	5	60,05	trimetilamina	IIA	2,0	59,11
gasolina		0,7	73,95	xileno	IIA	1,0	106,17
heptano	IIA	1,1	100,20	1,2-epoxipropano (óxido de propileno)	IIB	1,9	58,08
hexano	IIA	1,2	86,18	1,3,5-trioxano	IIB	3,6	90,08
hexano	IIIA	1,2	102,18	1,3-butadieno	IIB	1,4	54,09
keroseno	IIA	0,7	87,00	1,4-dioxano	IIB	1,9	88,11
metilamina	IIA	4,9	31,06	ácido cianhídrico	IIB	46,5	27,03
metilciclohexano	IIA	1,1	98,19	acrilato de etilo	IIB	1,7	100,12
monóxido de carbono	IIA	12,5	28,01	acrilato de metilo	IIB	2,4	86,09
naftaleno	IIA	0,9	128,17	acrilonitrilo	IIB	2,8	53,06
nitroetano	IIA	4,0	75,07	alcohol tetrahidrofurfúrico	IIB	1,5	102,13
nitrometano	IIA	7,1	61,04	ciclopropano	IIB	2,4	42,08
nonano	IIA	0,7	128,26	éter dibutílico	IIB	0,9	130,23
nonano	IIIA	8,0	144,26	éter dietílico	IIB	1,9	74,12
octano	IIA	6,0	114,23	etil metil éter	IIB	2,0	60,10
pentano	IIA	1,4	72,15	etileno	IIB	2,7	28,05
pentano	IIIA	1,2	88,15	furano	IIB	2,3	68,08
petróleo	IIA	1,0	87,00	gas de coquería	IIB	5,0	
piridina	IIA	1,7	79,10	metilacetileno (propino)	IIB	1,7	40,06
propano	IIA	2,0	44,10	nitrato de isopropilo	IIB	2,0	105,09
propano	IIIA	2,1	60,10	óxido de etileno (epoxietano)	IIB	2,6	44,05
propeno (propileno)	IIA	2,0	42,08	tetrahidrofurano	IIB	1,5	72,11
propilamina	IIA	2,0	59,11	acetileno	IIC	1,5	26,04
tolueno	IIA	1,2	92,14	disulfuro de carbono	IIC	1,0	76,13
trietilamina	IIA	1,2	53,15	hidrógeno	IIC	4,0	2,02



**APLICACIONES  
OFF-SHORE**



**APLICACIONES  
INDUSTRIA QUÍMICA**



**APLICACIONES  
MINERÍA Y OBRAS  
PUBLICAS**

# CUMPLIMIENTO DE NORMAS

Los ventiladores y extractores de SODECA, cumplen con las siguientes normativas:

<b>CALIDAD</b>	
<b>ISO 9001:2008</b>	Sistemas de gestión de la calidad. Requisitos. Quality management systems -- Requirements
<b>ENSAYOS</b>	
<b>ISO 5801</b>	Ventiladores industriales. Ensayos de comportamiento en circuitos normalizados. Industrial fans -- Performance testing using standardized airways
<b>AMCA 210-07</b>	Ventiladores industriales. Métodos de ensayos de ventiladores y su representación de ensayos. Laboratory Methods of Testing Fans for Aerodynamic Performance Rating
<b>UNE-EN ISO 5801</b>	Ventiladores. Dispositivos e instalaciones para el ensayo de ventiladores.
<b>UNE-EN ISO 13350</b>	Ventiladores industriales. Ensayos de comportamiento de ventiladores de chorro. Industrial fans -- Performance testing of jet fans
<b>ISO 13348</b>	Industrial fans -- Tolerances, methods of conversion and technical data presentation
<b>VENTILADORES PARA ALTA TEMPERATURA</b>	
<b>EN 12101-3</b>	Sistemas de control de humos y calor. Parte 3: Especificaciones para aireadores extractores de humos y calor mecánicos. Smoke and heat control systems - Part 3: Specification for powered smoke and heat exhaust ventilators
<b>ACÚSTICA</b>	
<b>ISO 3744</b>	Acústica. Determinación de los niveles de potencia acústica de fuentes de ruido a partir de la presión acústica. Método de ingeniería para condiciones de campo libre sobre un plano reflectante. Acoustics -- Determination of sound power levels of noise sources using sound pressure -- Engineering method in an essentially free field over a reflecting plane
<b>EQUILIBRADO Y VIBRACIONES</b>	
<b>ISO 1940-1</b>	Vibraciones mecánicas. Calidad de equilibrado Mechanical vibration -- Balance quality requirements for rotors in a constant (rigid) state -- Part 1: Specification and verification of balance tolerances
<b>ISO 10816-1</b>	Vibraciones mecánicas. Evaluación de las vibraciones de máquinas Mechanical vibration -- Evaluation of machine vibration by measurements on non-rotating parts -- Part 1: General guidelines
<b>ISO 14694</b>	Ventiladores industriales. Especificaciones para equilibrado y niveles de vibración Industrial fans -- Specifications for balance quality and vibration levels
<b>SEGURIDAD (Declaración de Conformidad CE)</b>	
<b>EN ISO 12100</b>	Seguridad de las máquinas. Conceptos básicos, principios generales para el diseño. Parte 1: Terminología básica, metodología. Safety of machinery -- Basic concepts, general principles for design -- Part 1: Basic terminology, methodology
<b>EN ISO 12100</b>	Seguridad de las máquinas. Conceptos básicos, principios generales para el diseño. Parte 2: Principios técnicos. Safety of machinery -- Basic concepts, general principles for design -- Part 2: Technical principles
<b>UNE EN 60204-1</b>	Seguridad de las máquinas. Equipo eléctrico de las máquinas. Parte 1: Requisitos generales. Safety of machinery - Electrical equipment of machines - Part 1: General requirements
<b>ISO 13857</b>	Seguridad de máquinas. Distancias de seguridad para impedir que se alcancen zonas peligrosas con los miembros superiores e inferiores. Safety of machinery -- Safety distances to prevent danger zones being reached by upper and lower limbs
<b>UNE-EN ISO 12499</b>	Ventiladores industriales. Seguridad mecánica en los ventiladores Industrial fans -- Mechanical safety of fans -- Guarding
<b>DIRECTIVAS Y REGLAMENTOS</b>	
<b>Directiva 2006/42/CE</b>	Directiva de máquinas Machinery Directive
<b>Directiva 2006/95/CE</b>	Directiva de baja tensión Low Voltage Directive
<b>Directiva 2004/108/CE</b>	Directiva compatibilidad electromagnética EMC Directive
<b>Reglamento 305/2011</b>	Directiva productos de construcción Construction Products Directive (CPR)
<b>Directiva 2009/125/CE</b>	Directiva de requisitos de diseño ecológico para productos que utilizan energía. Ecodesign Requirements for Energy-related Products Directive

## EJECUCIONES ATEX

<b>Directiva ATEX 94/9/CE</b>	Aparatos y sistemas de protección para uso en atmósferas potencialmente explosivas Equipment and protective systems intended for use in potentially explosive atmospheres
<b>EN 14986</b>	Diseño de ventiladores para trabajar en atmósferas potencialmente explosivas. Design of fans working in potentially explosive atmospheres
<b>EN 13463-1</b>	Equipos no eléctricos destinados a atmósferas potencialmente explosivas. Parte 1: Requisitos y metodología básica. Non-electrical equipment for use in potentially explosive atmospheres - Part 1: Basic method and requirements
<b>EN 1127-1</b>	Atmósferas explosivas. Prevención y protección contra la explosión. Parte 1: Conceptos básicos y metodología. Explosive atmospheres - Explosion prevention and protection - Part 1: Basic concepts and methodology







# HEAVY DUTY FANS FOR INDUSTRIAL APPLICATIONS



Sodeca se ha especializado desde sus orígenes en el diseño y la fabricación de ventiladores y sus accesorios para aplicaciones industriales.

La unión de la experiencia adquirida durante décadas de trabajo con ventiladores, junto con la tecnología aportada por ingenieros distribuidos en diferentes departamentos, ha permitido que Sodeca se sitúe entre los mayores fabricantes de ventilación industrial del mundo.

Las aplicaciones industriales requieren gran capacidad de adaptación a las especificaciones de cada proyecto y flexibilidad en la fabricación, para cumplir con las necesidades reales de cada cliente.

Para cumplir con este objetivo Sodeca dispone de una línea de productos Standard y una línea de productos de fabricación especial, para la construcción de ventiladores adaptados a las exigencias de nuestros clientes.

Durante años se ha invertido de forma constante, en el desarrollo de procesos y aplicaciones internas, para conseguir la fabricación y el suministro de ventiladores industriales especiales, con un tiempo de diseño y fabricación extremadamente reducido.

El trabajo en equipo de nuestro departamento de ingeniería, junto con universidades y centros tecnológicos, así como la estrecha colaboración entre los departamentos de diseño de nuestros colaboradores externos, hace posible conseguir innovadoras soluciones de ventilación industrial en un corto plazo de tiempo.

A lo largo de nuestra historia hemos desarrollado todo tipo de tecnología en ventiladores para aplicaciones industriales que actualmente están repartidos por todo el mundo, nuestro objetivo es seguir invirtiendo en este sector para seguir siendo uno de los fabricantes de ventiladores industriales más reconocidos en el mundo.



# STANDARDS COMPLIANCE FOR RAILWAY AND ROLLING EQUIPMENT

## Related standards:

**GOST 30630.0.0-99** Environment stability test methods for machines, instruments and other industrial products.

**GOST 28231-89** (IEC 68-2-47-82) Basic methods of testing for exposure to external factors. Part 2. Testing. Fastening of elements, tools and other products in the course of dynamic testing. Including shock (Ea), multiple shock (Eb), vibration (Fc and Fd), linear acceleration (Ga) and Guidance.

**GOST 30630.1.1-99** Methods of testing for resistance of machinery, instruments and other technical products to externally acting mechanical factors. Determining dynamic characteristics of a structure.

**GOST 30630.1.2-99** Methods of testing for resistance of machinery, instruments and other technical products to externally acting mechanical factors. Vibration testing.

- . Testing for stability under exposure to sinusoidal or accidental wide-band vibration.
- . Long-run testing for durability under exposure to sinusoidal or accidental wide-band vibration (long-run chatter testing).
- . Testing for durability under exposure to multiple mechanical shocks (shock strength testing).

**GOST 30631-99** General requirements to machinery, instruments and other technical products with regard to resistance to externally acting mechanical factors during operation.

**GOST 17516.1** 1990-MAY-23

Electrotechnical articles general requirements for stability to effect of environmental mechanical factors – Incorporates Amendment 1: 11/21/1997

**UNE-EN 61373** Aplicaciones Ferroviarias, Material rodante, Ensayos de choque y vibración. Railway applications. Rolling equipment. Shock and vibration tests

## Vibrations

The table presented below shows the vibration requirements for mounted equipment in A-Class vehicle. Sodeca fans complies GOST vibration requirements which are the most restrictive.

### EN Standard

Standard number	Vibration type	Vibration RMS X Axis [m/s <sup>2</sup> ]	Vibration RMS Y Axis [m/s <sup>2</sup> ]	Vibration RMS Z Axis [m/s <sup>2</sup> ]	Vibration frequency [Hz]
EN 61373-2011	Increased random vibrations	2,83	2,09	4,25	-
	Standard random vibrations	0,50	0,37	0,75	-

### GOST Standard

Standard number	Vibration type	Vibration amplitude X Axis [m/s <sup>2</sup> ]	Vibration amplitude Y Axis [m/s <sup>2</sup> ]	Vibration amplitude Z Axis [m/s <sup>2</sup> ]	Vibration frequency [Hz]
GOST 17516.1-1990 + GOST 16692.2 & GOST 30631-1999 + GOST 30630.0.0	Long term sinusoidal vibrations	15	15	15	10-100
GOST 30631-1999 + GOST 30630.0.0	Short term sinusoidal vibrations	10	10	10	10-100

The next two figures shows displacement and stress maps for a Sodeca fan under the vibration required by GOST standard in the Y axis. The test method consists in 687 repetitions 7 minutes long. The vibration is simulated with a sinusoidal acceleration of 15 m/s<sup>2</sup> amplitude and frequency 100 Hz. At the end of the test the fan has to endure 28.8 million of cycles.

Fan's displacement map after the test. The displacement that is shown in the image has been increased to make it visible. The maximum displacement is 1.06 mm.

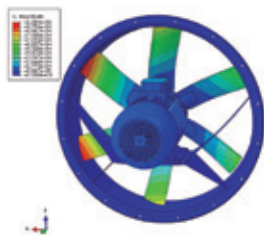

Fan's stress map after the test. The maximum stress is 69.7 MPa for steel parts and 65 MPa for aluminium parts. It is the maximum for all axes.

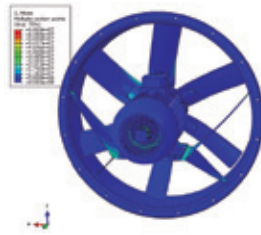

The cast aluminium's fatigue limit for 28.8 million cycles is about 80 MPa. All Aluminium parts have a stress below 65 MPa, so all this parts meet the requirements. The steel's fatigue limit is much higher than aluminium, so all steel parts meets too the requirements.

ASCAMM technology centre studies Sodeca fans to assure the compliance with GOST and EN standards for products mounted in railway and rolling equipment. ASCAMM uses numerical simulations to check the fan design under the vibration and shock conditions required by the standards.



## Impacts

The table presented below shows the impact requirements for mounted equipment in A-Class vehicle. Sodeca fans complies EN-61737 impact requirements which are the most restrictive.

Impact requirements	EN 61373-2011
Acceleration X Axis [m/s <sup>2</sup> ]	50
Acceleration Y Axis [m/s <sup>2</sup> ]	30
Acceleration Z Axis [m/s <sup>2</sup> ]	30
Duration [m/s]	30

**GOST 17516.1-1990 + GOST 16692.2 & GOST 30631-1999 + GOST 30630.0.0**  
30 m/s<sup>2</sup> (only one axis) Duration: 2-20 ms

The next two figures shows displacement and stress maps for a Sodeca fan under the impact requirement of EN-61373-2011 standard. The fan receives an impact with 30 m/s<sup>2</sup> acceleration and 30 ms duration in the Y axis.

Fan's displacement map after impact. The displacement that is shown in the image has been increased to make it visible. The maximum displacement is 0.12 mm.

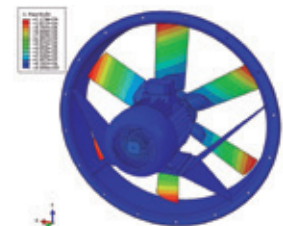

Fan's stress map after the impact. The maximum stress is 23.5 MPa for all axes; it is situated in the steel frame.

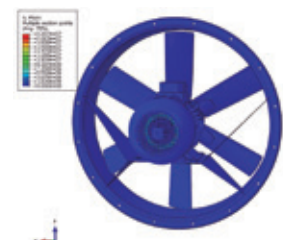

The test result confirms that the fan can resist the impact required by the standard, because 23.5 MPa is a stress value too low for steels.

# TYPE APPROVAL CERTIFICATE FOR MARINE AND OFFSHORE APPLICATIONS

Los extractores SODECA para aplicaciones navales & off-shore, son reconocidos por su calidad y buen funcionamiento en estas aplicaciones, por la mayoría de constructores de barcos, así como empresas de defensa civil del mundo. Los extractores bajo demanda pueden cumplir con los diferentes requerimientos de las sociedades de clasificación y certificación.

Los motores marinos utilizados están certificados por la mayoría de entidades internacionales de clasificación naval:

ABS:	América Bureau of shipping
BV:	Bureau Veritas
CCS:	China Classification Societies
CR:	China Corporation Register of Shipping
DNV:	Det Norske Veritas
GL:	Germanischer Lloyd
KR:	Korean Register of shipping
LR:	Lloyd's Register of Shipping
NK:	Nippon Kaiji Kyokai
RINA:	Registro Italiano Navale
RS:	Russian Maritime Register of Shipping

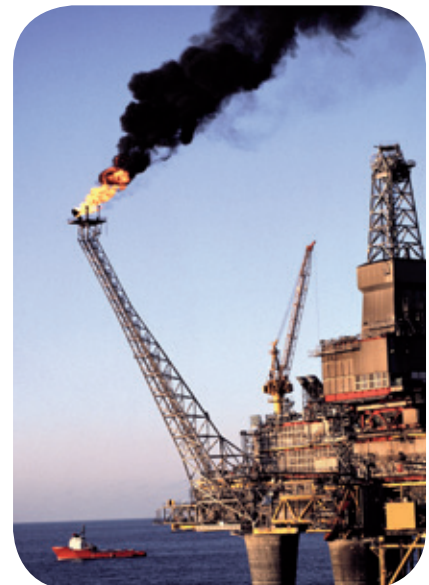

# HEAVY DUTY FANS

PARA APLICACIONES INDUSTRIALES, NAVALES & OFF-SHORE, INDUSTRIA QUÍMICA, MINERÍA, OBRAS PÚBLICAS, PLANTAS DE ENERGÍA Y APLICACIONES FERROVIARIAS



## CENTRIFUGOS

<b>CMRS</b>  Ventiladores centrífugos de media presión y simple aspiración, de gran robustez, equipados con turbina con álabes hacia atrás 14	<b>CASB</b>  Ventiladores centrífugos de alta presión y simple aspiración con envolvente y turbina en chapa de acero 20	<b>CAB</b>  Ventiladores centrífugos de alta presión y simple aspiración de gran robustez. 26	<b>CMRS-X</b>  Ventiladores accionados a transmisión, equipados con motor eléctrico y turbina con álabes a reacción 31
<b>CASB-X</b>  Ventiladores centrífugos accionados a transmisión, equipados con motor eléctrico 39	<b>CMP/MAR</b>  Extractores centrífugos de media presión equipados con turbina multipala para aplicaciones marinas 48	<b>CMPI</b>  Extractores centrífugos de media presión equipados con turbina multipala construidos en acero inoxidable AISI-304 52	<b>CMRG</b>  Extractores centrífugos de media presión y simple aspiración, galvanizados en caliente, para trabajar en ambientes químicos, agresivos o marinos. 56
<b>CPV</b>  Ventiladores centrífugos anticorrosivos de simple aspiración fabricados en polipropileno 62	<b>CMRH</b>  Ventiladores accionados a transmisión, con motor eléctrico para trabajo horizontal 67		

## HELICOIDALES

<b>HFW</b>  Ventiladores tubulares galvanizados en caliente 72	<b>HTP</b>  Extractores axiales tubulares de alta presión 77	<b>HBA</b>  Ventiladores helicoidales tubulares bifurcados, con motor fuera del flujo de aire 93	<b>HTMH</b>  Extractores de cubierta multifuncional para grandes caudales 122
<b>HPX/SEC</b>  Ventiladores para extremas condiciones en hornos y secaderos 95	<b>HGT HGTX</b>  Ventiladores helicoidales tubulares de gran diámetro con motor directo o motor exterior 97	<b>HCT/MAR HFT/MAR</b>  Extractores helicoidales tubulares para aplicaciones marinas y navales 119	

# EXTRACTORES PARA: **ATMÓSFERAS EXPLOSIVAS ATEX**



## HCDF



Extractores helicoidales con marco cuadrado, con Certificación ATEX Ex d

131

## HDF



Extractores helicoidales con marco circular, con Certificación ATEX Ex d

131

## HC/ATEX

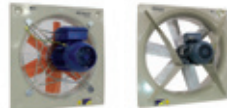

Extractores helicoidales murales, con Certificación ATEX y posible marcado Ex e, EX d, Ex tc y Ex tb

134

## HCH/ATEX



Extractores helicoidales murales de gran robustez, con Certificación ATEX

140

## HCT/ATEX



Extractores helicoidales tubulares de gran robustez, con Certificación ATEX

140

## HTM/ATEX



Extractores tubulares móviles, con Certificación ATEX

147

## HPX/ATEX



Extractores helicoidales tubulares, con motor exterior y Certificación ATEX

149

## CPV/ATEX



Extractores centrifugos anticorrosivos en material plástico, con certificación ATEX

152

## CMA/ATEX



Extractores centrifugos de media presión en fundición de aluminio, con certificación ATEX

155

## CMP/ATEX



Extractores centrifugos de media presión equipados con turbina multipala, con certificación ATEX

158

## CMP/AL C JMP/AL



Ventiladores en aluminio con certificado para salas de calderas de gas natural

166

## CMR/ATEX



Extractores centrifugos de media presión y gran robustez, equipados con turbina a reacción, con certificación ATEX

168

## CAS/ATEX



Extractores centrifugos de alta presión y simple aspiración, con certificación ATEX

171

## CA/ATEX



Extractores centrifugos de alta presión y simple aspiración en fundición de aluminio, con certificación ATEX

176

## HT/ATEX



Extractores helicoidales de tejado, con Certificación ATEX y posible marcado Ex e, Ex d, Ex tc y Ex tb

179

## RFHD



Extractores centrifugos de tejado con salida horizontal y certificación ATEX Ex d

182

## CVT/ATEX CHT/ATEX



Extractores centrifugos de tejado con salida horizontal o vertical, con Certificación ATEX

186

## KIT SOBREPRESIÓN



190

# CMRS

**Ventiladores centrifugos de media presión y simple aspiración, de gran robustez, equipados con turbina con álabes hacia atrás**



Ventilador:

- Envoltorio en chapa de acero
- Turbina con álabes a reacción, en chapa de acero de gran robustez, especialmente diseñada para transportar aire limpio o ligeramente polvoriento
- Motor directamente acoplado

Motor:

- Motores de eficiencia IE3 para potencias iguales o superiores a 7,5kW, excepto monofásicos, 2 velocidades y 8 polos
- Motores clase F, con rodamientos a bolas, protección IP55
- Trifásicos 230/400V-50Hz (hasta 4kW) y 400/690V-50Hz (potencias superiores a 4kW)
- Temperatura máxima del aire a transportar: -20°C + 120°C

Acabado:

- Anticorrosivo en resina de poliéster polimerizada a 190 °C, previo desengrase con tratamiento nanotecnológico libre de fosfatos.

Bajo demanda:

- Bobinados especiales para diferentes tensiones
- Ventilador preparado para transportar aire hasta 250°C
- Ventilador en acero inoxidable
- Certificación ATEX Categoría 2
- Motores de eficiencias IE2 e IE3 para cualquier potencia



Turbina a reacción de alto rendimiento, y gran robustez

## Código de pedido

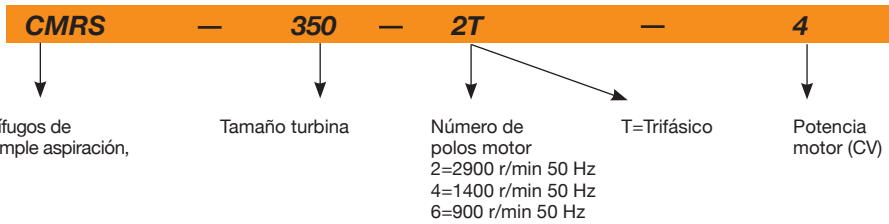

## Características técnicas

Modelo	Velocidad (r/min)	Intensidad máx admisible (A)			Potencia instalada (kW)	Caudal máximo (m3/h)	Nivel Presión Sonora dB(A)	Peso aprox (Kg)
		230 V	400 V	690 V				
CMRS-350-2T-4	2900	10,18	5,88		3,00	7750	77	77
CMRS-350-4T-0.5	1380	1,84	1,06		0,37	3900	65	50
CMRS-400-2T-5.5	2880	13,30	7,63		4,00	9700	79	98
CMRS-400-2T-7.5	2920		10,40	6,00	5,50	12100	82	107
CMRS-400-4T-0.75	1420	2,28	1,31		0,55	5400	67	69
CMRS-450-2T-10 IE3	2935		13,90	8,06	7,50	13600	83	141
CMRS-450-2T-15 IE3	2950		20,10	11,70	11,00	17200	84	198
CMRS-450-4T-1	1410	3,10	1,79		0,75	6850	69	78
CMRS-450-4T-1.5	1420	4,33	2,50		1,10	7700	70	84
CMRS-500-2T-20 IE3	2950		27,10	15,70	15,00	19400	88	231
CMRS-500-2T-25 IE3	2950		33,30	19,30	18,50	24300	89	250
CMRS-500-4T-2	1430	5,96	3,44		1,50	9750	71	117
CMRS-500-4T-3	1445	8,36	4,83		2,20	10850	72	129
CMRS-500-6T-0.75	910	2,59	1,49		0,55	6900	61	107
CMRS-560-4T-4	1445	10,96	6,33		3,00	13600	73	148
CMRS-560-4T-5.5	1440	14,10	8,12		4,00	17300	73	160
CMRS-560-6T-1	945	3,90	2,20		0,75	8650	62	129
CMRS-560-6T-1.5	945	4,88	2,82		1,10	9650	65	135
CMRS-630-4T-7.5	1460		10,60	6,10	5,50	19100	75	193
CMRS-630-4T-10 IE3	1465		13,90	8,06	7,50	24600	75	227
CMRS-630-6T-2	955	6,42	3,71		1,50	12200	66	167
CMRS-630-6T-3	955	9,30	5,30		2,20	15350	68	177
CMRS-710-4T-15 IE3	1470		20,70	12,00	11,00	27550	78	352
CMRS-710-4T-20 IE3	1470		28,40	16,50	15,00	34900	78	377
CMRS-710-6T-4	960	11,90	6,80		3,00	17200	70	276
CMRS-710-6T-5.5	960	16,50	9,46		4,00	21700	71	287
CMRS-800-4T-25 IE3	1470		34,90	20,20	18,50	38250	81	480
CMRS-800-4T-30 IE3	1470		40,90	23,70	22,00	48250	83	503
CMRS-800-6T-7.5	965		12,30	7,10	5,50	24400	74	357

Características técnicas

Modelo	Velocidad (r/min)	Intensidad máx admisible (A)			Potencia instalada (kW)	Caudal máximo (m3/h)	Nivel Presión Sonora dB(A)	Peso aprox (Kg)
		230 V	400 V	690 V				
CMRS-800-6T-10 IE3	975		14,70	8,52	7,50	30900	74	412
CMRS-900-4T-50 IE3	1480		65,60	38,00	37,00	54300	85	810
CMRS-900-4T-60 IE3	1480		79,40	46,00	45,00	69550	85	849
CMRS-900-6T-15 IE3	975		21,50	12,50	11,00	34650	76	521
CMRS-900-6T-20 IE3	975		28,00	16,20	15,00	42600	76	583
CMRS-1000-4T-75 IE3	1480		96,90	56,20	55,00	76650	87	1082
CMRS-1000-4T-100 IE3	1485		130,00	75,40	75,00	96150	88	1319
CMRS-1000-6T-25 IE3	980		35,20	20,40	18,50	48750	77	783
CMRS-1000-6T-30 IE3	980		41,70	24,20	22,00	61800	78	810
CMRS-1120-6T-40 IE3	985		54,20	31,40	30,00	71500	80	1081
CMRS-1120-6T-50 IE3	985		66,60	38,60	37,00	85950	80	1261
CMRS-1250-6T-75 IE3	990		102,00	59,10	55,00	98300	83	1618
CMRS-1250-6T-100 IE3	990		136,00	78,80	75,00	121200	84	1947
CMRS-1400-6T-125 IE3	990		163,00	94,50	90,00	142150	87	2328
CMRS-1400-6T-150 IE3	992		199,00	115,00	110,00	173400	88	2476



Erp. Características del punto de máxima eficiencia (BEP)

<b>MC</b>	Categoría de medición	<b>ηe[%]</b>	Eficiencia
<b>EC</b>	Categoría de eficiencia	<b>N</b>	Grado de eficiencia
	<b>S</b> Estática	<b>[kW]</b>	Potencia eléctrica
	<b>T</b> Total	<b>[m³/h]</b>	Caudal
<b>VSD</b>	Variador de velocidad	<b>[mmH₂O]</b>	Presión estática o total (Según EC)
<b>SR</b>	Relación específica	<b>[RPM]</b>	Velocidad

Modelo	MC	EC	VSD	SR	ηe [%]	N	[kW]	[m³/h]	[mmH₂O]	[RPM]
CMRS-350-2T-4	B	T	NO	1,01	68,9%	74,1	3,22	5375	151,37	2909
CMRS-350-4T-0.5	B	T	NO	1,00	51,4%	66,0	0,41	2077	37,03	1410
CMRS-400-2T-5.5	B	T	NO	1,02	71,0%	74,6	4,54	7095	166,64	2883
CMRS-400-2T-7.5	B	T	NO	1,02	64,3%	66,9	5,69	6843	196,27	2928
CMRS-400-4T-0.75	B	T	NO	1,00	57,9%	70,1	0,70	3653	40,80	1425
CMRS-450-2T-10 IE3	B	T	NO	1,02	69,5%	70,4	8,23	9917	211,65	2935
CMRS-450-2T-15 IE3	B	T	NO	1,03	69,3%	69,5	9,46	9179	261,99	2960
CMRS-450-4T-1	B	T	NO	1,00	67,6%	78,5	0,90	5106	43,87	1414
CMRS-450-4T-1.5	B	T	NO	1,01	61,4%	71,1	1,20	4557	59,25	1429
CMRS-500-2T-20 IE3	B	T	NO	1,02	72,1%	71,8	14,09	14752	252,78	2956
CMRS-500-2T-25 IE3	B	T	NO	1,03	73,8%	73,3	17,06	14514	318,32	2957
CMRS-500-4T-2	B	T	NO	1,01	68,4%	76,6	1,68	6605	63,93	1435
CMRS-500-4T-3	B	T	NO	1,01	64,3%	71,2	2,22	6865	76,33	1453
CMRS-500-6T-0.75	B	T	NO	1,00	57,8%	70,1	0,67	4520	31,68	922
CMRS-560-4T-4	B	T	NO	1,01	68,5%	73,6	3,27	10166	80,96	1449
CMRS-560-4T-5.5	B	T	NO	1,01	63,4%	67,8	3,86	10373	86,71	1450
CMRS-560-6T-1	B	T	NO	1,00	62,9%	74,1	0,84	6860	28,36	953
CMRS-560-6T-1.5	B	T	NO	1,00	58,4%	67,9	1,24	6860	38,87	951
CMRS-630-4T-7.5	B	T	NO	1,01	69,8%	72,2	5,93	14449	105,24	1462
CMRS-630-4T-10 IE3	B	T	NO	1,01	69,5%	71,6	6,19	12133	130,02	1474
CMRS-630-6T-2	B	T	NO	1,00	59,6%	67,9	1,64	8230	43,60	961
CMRS-630-6T-3	B	T	NO	1,00	63,1%	70,0	2,21	11941	42,93	963
CMRS-710-4T-15 IE3	B	T	NO	1,01	69,2%	69,2	10,09	17818	143,77	1475
CMRS-710-4T-20 IE3	B	T	NO	1,02	67,6%	67,7	10,30	14917	171,44	1481
CMRS-710-6T-4	B	T	NO	1,01	67,9%	73,1	3,16	12584	62,51	965
CMRS-710-6T-5.5	B	T	NO	1,01	66,1%	70,7	3,69	12910	69,32	969
CMRS-800-4T-25 IE3	B	T	NO	1,02	76,0%	75,4	18,44	28002	183,75	1472
CMRS-800-4T-30 IE3	B	T	NO	1,02	71,9%	71,2	19,69	25219	206,07	1475
CMRS-800-6T-7.5	B	T	NO	1,01	71,4%	74,1	5,62	17719	83,15	969
CMRS-800-6T-10 IE3	B	T	NO	1,01	73,9%	76,1	6,22	19365	87,19	981
CMRS-900-4T-50 IE3	B	T	NO	1,02	72,2%	71,0	33,02	34349	254,74	1483
CMRS-900-4T-60 IE3	B	T	NO	1,03	70,2%	68,8	36,75	36275	260,99	1485
CMRS-900-6T-15 IE3	B	T	NO	1,01	78,2%	78,5	9,42	27074	99,84	980
CMRS-900-6T-20 IE3	B	T	NO	1,01	67,6%	67,6	10,60	22448	117,22	984
CMRS-1000-4T-75 IE3	B	T	NO	1,03	73,8%	72,0	54,83	53731	276,32	1481
CMRS-1000-4T-100 IE3	B	T	NO	1,03	71,7%	69,7	63,44	53731	310,63	1488
CMRS-1000-6T-25 IE3	B	T	NO	1,01	73,1%	72,6	17,19	37016	124,62	983
CMRS-1000-6T-30 IE3	B	T	NO	1,01	76,8%	76,3	17,19	38047	127,35	985
CMRS-1120-6T-40 IE3	B	T	NO	1,02	73,1%	72,1	25,10	41891	160,68	988
CMRS-1120-6T-50 IE3	B	T	NO	1,02	76,2%	75,0	30,96	46933	184,42	988





Dimensiones mm

Boca impulsión

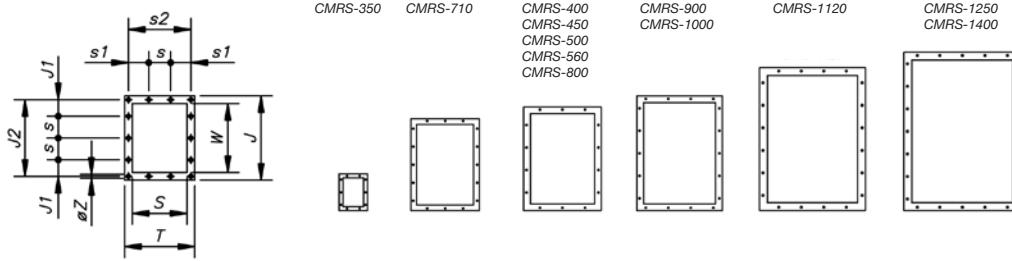

	T	J	J1	J2	S	s	s1	s2	W	ØZ
CMRS-350-2T-4	336	441	77,5	405	256	125	87,5	300	361	12
CMRS-350-4T-0.5	336	441	77,5	405	256	125	87,5	300	361	12
CMRS-400-2T-5.5	368	484	36,5	448	288	125	41	332	404	12
CMRS-400-2T-7.5	368	484	36,5	448	288	125	41	332	404	12
CMRS-400-4T-0.75	368	484	36,5	448	288	125	41	332	404	12
CMRS-450-2T-10	402	533	61	497	322	125	58	366	453	12
CMRS-450-2T-15	402	533	61	497	322	125	58	366	453	12
CMRS-450-4T-1	402	533	61	497	322	125	58	366	453	12
CMRS-450-4T-1.5	402	533	61	497	322	125	58	366	453	12
CMRS-500-2T-20	441	587	88	551	361	125	77,5	405	507	12
CMRS-500-2T-25	441	587	88	551	361	125	77,5	405	507	12
CMRS-500-4T-2	441	587	88	551	361	125	77,5	405	507	12
CMRS-500-4T-3	441	587	88	551	361	125	77,5	405	507	12
CMRS-500-6T-0.75	441	587	88	551	361	125	77,5	405	507	12
CMRS-560-4T-4	504	669	74,5	629	404	160	72	464	569	14
CMRS-560-4T-5.5	504	669	74,5	629	404	160	72	464	569	14
CMRS-560-6T-1	504	669	74,5	629	404	160	72	464	569	14
CMRS-560-6T-1.5	504	669	74,5	629	404	160	72	464	569	14
CMRS-630-4T-7.5	553	738	109	698	453	160	96,5	513	638	14
CMRS-630-4T-10	553	738	109	698	453	160	96,5	513	638	14
CMRS-630-6T-2	553	738	109	698	453	160	96,5	513	638	14
CMRS-630-6T-3	553	738	109	698	453	160	96,5	513	638	14
CMRS-710-4T-15	607	815	67,5	775	507	160	123,5	567	715	14
CMRS-710-4T-20	607	815	67,5	775	507	160	123,5	567	715	14
CMRS-710-6T-4	607	815	67,5	775	507	160	123,5	567	715	14
CMRS-710-6T-5.5	607	815	67,5	775	507	160	123,5	567	715	14
CMRS-800-4T-25	689	921	35,5	871	569	200	119,5	639	801	14
CMRS-800-4T-30	689	921	35,5	871	569	200	119,5	639	801	14
CMRS-800-6T-7.5	689	921	35,5	871	569	200	119,5	639	801	14
CMRS-800-6T-10	689	921	35,5	871	569	200	119,5	639	801	14
CMRS-900-4T-50	758	1018	84	968	638	200	54	708	898	14
CMRS-900-4T-60	758	1018	84	968	638	200	54	708	898	14
CMRS-900-6T-15	758	1018	84	968	638	200	54	708	898	14
CMRS-900-6T-20	758	1018	84	968	638	200	54	708	898	14
CMRS-1000-4T-75	835	1127	108,5	1017	715	200	92,5	785	1007	14
CMRS-1000-4T-100	835	1127	108,5	1017	715	200	92,5	785	1007	14
CMRS-1000-6T-25	835	1127	108,5	1017	715	200	92,5	785	1007	14
CMRS-1000-6T-30	835	1127	108,5	1017	715	200	92,5	785	1007	14
CMRS-1120-6T-40	941	1270	105	1210	801	200	140,5	881	1130	18
CMRS-1120-6T-50	941	1270	105	1210	801	200	140,5	881	1130	18
CMRS-1250-6T-75	1038	1407	73,5	1347	898	200	89	978	1267	18
CMRS-1250-6T-100	1038	1407	73,5	1347	898	200	89	978	1267	18
CMRS-1400-6T-125	1147	1561	150,5	1501	1007	200	143,5	1087	1421	18
CMRS-1400-6T-150	1147	1561	150,5	1501	1007	200	143,5	1087	1421	18

**Curvas Características**

Q= Caudal en m<sup>3</sup>/h, m<sup>3</sup>/s y cfm

Pe= Presión estática en mmH<sub>2</sub>O, Pa e inwg

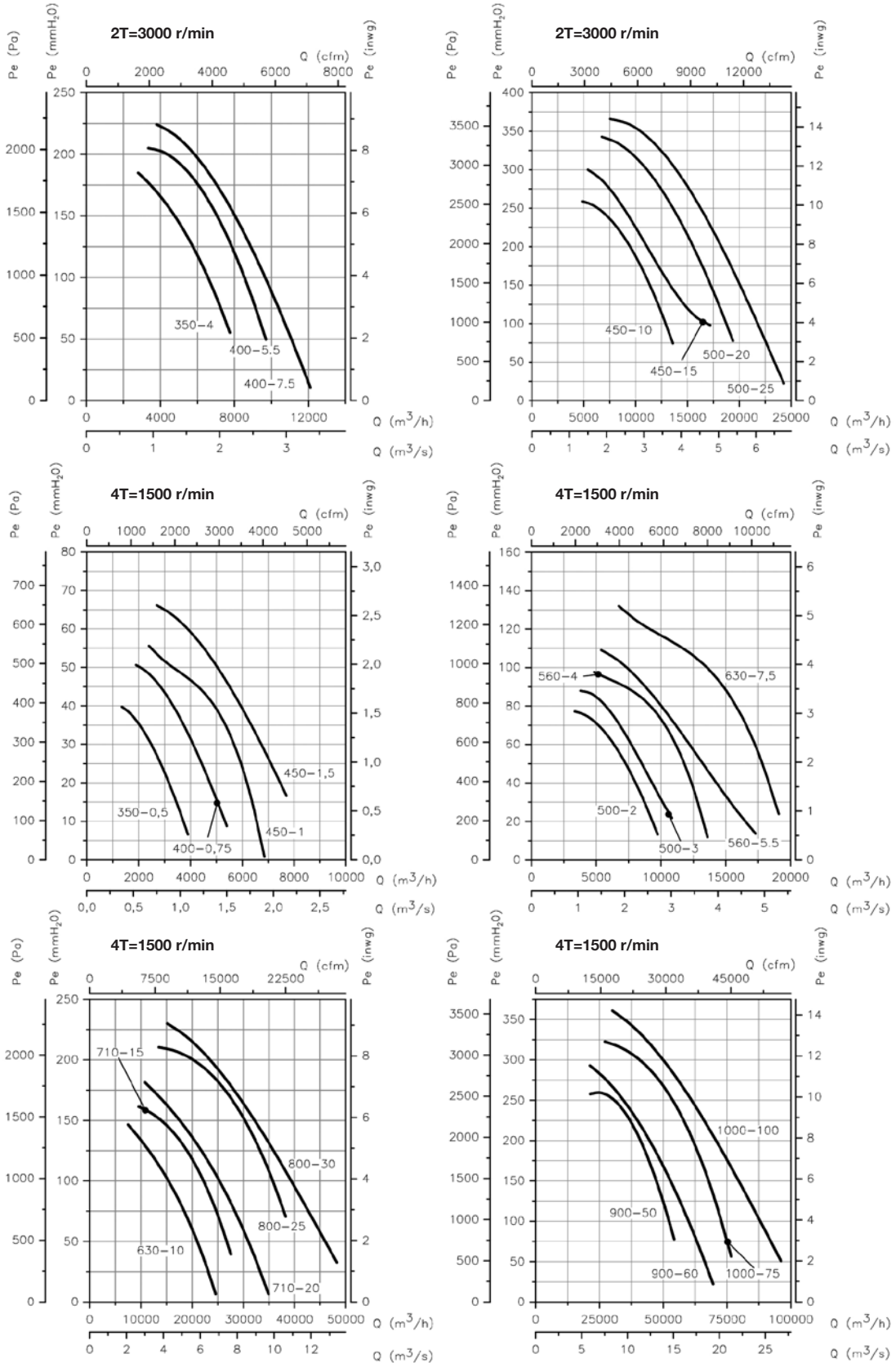

**Curvas Características**

Q= Caudal en m<sup>3</sup>/h, m<sup>3</sup>/s y cfm

Pe= Presión estática en mmH<sub>2</sub>O, Pa e inwg

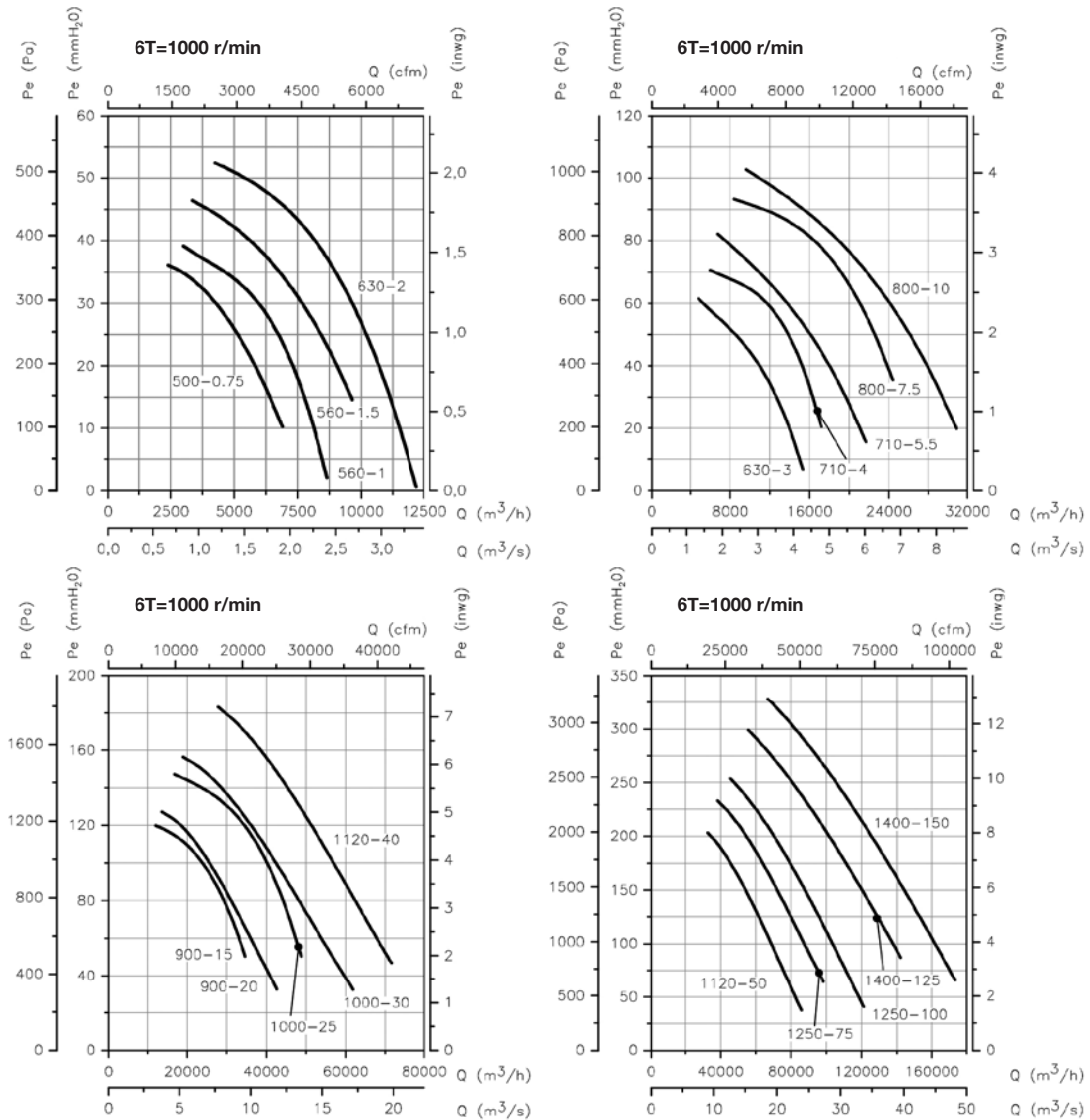

**Orientaciones**

Suministro estándar LG270, otras posiciones bajo demanda.  
 Modelos del 350 al 710 orientables. Medidas especiales en posiciones 180 y 225.  
 Modelos del 800 al 900 orientables. Medidas especiales excepto posición 315.  
 Modelos del 1000 al 1400 no orientables. Medidas especiales excepto posición 315.

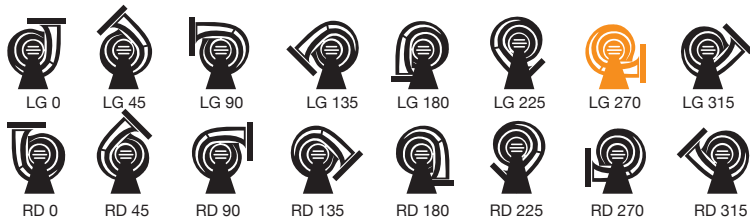

**Accesorios**

Ver apartado accesorios.



# CASB

**Ventiladores centrifugos de alta presión y simple aspiración de gran robustez, con envolvente y turbina en chapa de acero**

**HEAVY DUTY**



Ventilador:

- Envolvente en chapa de acero
- Turbina con álabes hacia atrás, en chapa de acero de gran robustez, especialmente diseñada para transportar aire limpio y aire polvoriento o ligeramente granulado
- Motor directamente acoplado

Motor:

- Motores de eficiencia IE3 para potencias iguales o superiores a 7,5kW, excepto monofásicos, 2 velocidades y 8 polos
- Motores clase F, con rodamientos a bolas, protección IP55
- Trifásicos 230/400V-50Hz (hasta 4kW) y 400/690V-50Hz (potencias superiores a 4kW)
- Temperatura máxima del aire a transportar: -20°C + 120°C

Acabado:

- Anticorrosivo en resina de poliéster polimerizada a 190 °C, previo desengrase con tratamiento nanotecnológico libre de fosfatos.

Bajo demanda:

- Bobinados especiales para diferentes tensiones
- Ventilador preparado para transportar aire hasta 250°C
- Ventilador en acero inoxidable
- Certificación ATEX Categoría 2
- Motores de eficiencias IE2 e IE3 para cualquier potencia

## Código de pedido

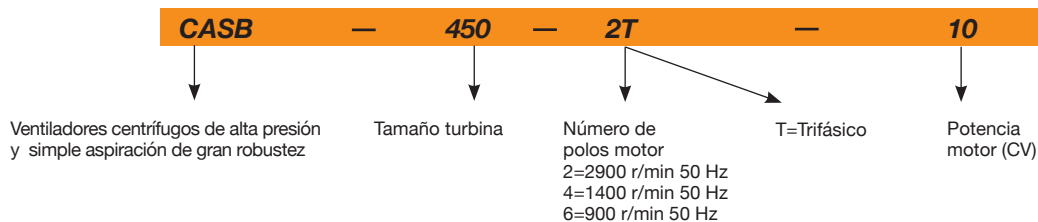

## Características técnicas

Modelo	Velocidad (r/min)	Intensidad máx admisible (A)			Potencia instalada (kW)	Caudal máximo (m³/h)	Nivel Presión Sonora dB(A)	Peso aprox (Kg)
		230 V	400 V	690 V				
CASB-350-2T-3	2860	7,75	4,48		2,20	3950	70	68
CASB-400-2T-5.5	2880	13,30	7,63		4,00	5550	74	105
CASB-450-2T-10 IE3	2935		13,90	8,06	7,50	7900	77	150
CASB-500-2T-15 IE3	2950		20,10	11,70	11,00	10800	80	230
CASB-500-4T-1.5	1420	4,33	2,50		1,10	5020	62	129
CASB-560-2T-20 IE3	2950		27,10	15,70	15,00	13750	83	282
CASB-560-2T-25 IE3	2950		33,30	19,30	18,50	15900	83	292
CASB-560-4T-3	1445	8,36	4,83		2,20	7800	65	138
CASB-630-2T-40 IE3	2965		53,50	31,00	30,00	19450	86	382
CASB-630-2T-50 IE3	2965		65,60	38,00	37,00	22700	88	392
CASB-630-4T-5.5	1440	14,10	8,12		4,00	10780	71	217
CASB-710-4T-7.5	1460		10,60	6,10	5,50	13000	71	272
CASB-710-4T-10 IE3	1465		13,90	8,06	7,50	15300	73	281
CASB-800-4T-15 IE3	1470		20,70	12,00	11,00	19300	76	421
CASB-800-4T-20 IE3	1470		28,40	16,50	15,00	22450	76	396
CASB-800-6T-5.5	960	16,50	9,46		4,00	13700	66	337
CASB-900-4T-30 IE3	1470		40,90	23,70	22,00	27550	78	581
CASB-900-4T-40 IE3	1480		56,10	32,50	30,00	31800	79	672
CASB-900-6T-10 IE3	975		14,70	8,52	7,50	19550	68	486
CASB-1000-4T-50 IE3	1480		65,60	38,00	37,00	38600	82	752
CASB-1000-4T-60 IE3	1480		79,40	46,00	45,00	42900	84	759
CASB-1000-6T-15 IE3	975		21,50	12,50	11,00	26750	73	614
CASB-1000-6T-20 IE3	975		28,00	16,20	15,00	29700	73	640

## Características técnicas

Modelo	Velocidad (r/min)	Intensidad máx admisible (A)			Potencia instalada (kW)	Caudal máximo (m³/h)	Nivel Presión Sonora dB(A)	Peso aprox (Kg)
		230 V	400 V	690 V				
CASB-1120-4T-75 IE3	1480	96,90	56,20	55,00	55100	86	1143	
CASB-1120-4T-100 IE3	1485	130,00	75,40	75,00	63050	86	1215	
CASB-1120-6T-25 IE3	980	35,20	20,40	18,50	38000	76	969	
CASB-1120-6T-30 IE3	980	41,70	24,20	22,00	41600	77	991	
CASB-1250-4T-150 IE3	1490	192,00	111,00	110,00	78600	89	1466	
CASB-1250-4T-175 IE3	1490	230,00	133,00	132,00	87500	90	1537	
CASB-1250-6T-40 IE3	985	54,20	31,40	30,00	51550	79	1222	
CASB-1250-6T-50 IE3	985	66,60	38,60	37,00	57400	79	1319	
CASB-1400-6T-60 IE3	990	83,40	48,30	45,00	64350	81	1829	
CASB-1400-6T-100 IE3	990	136,00	78,80	75,00	85800	83	1951	



## Erp. Características del punto de máxima eficiencia (BEP)

<b>MC</b>	Categoría de medición	<b>ηe [%]</b>	Eficiencia
<b>EC</b>	Categoría de eficiencia	<b>N</b>	Grado de eficiencia
<b>S</b>	Estática	<b>[kW]</b>	Potencia eléctrica
<b>T</b>	Total	<b>[m³/h]</b>	Caudal
<b>VSD</b>	Variador de velocidad	<b>[mmH₂O]</b>	Presión estática o total (Según EC)
<b>SR</b>	Relación específica	<b>[RPM]</b>	Velocidad

Modelo	MC	EC	VSD	SR	ηe [%]	N	[kW]	[m³/h]	[mmH₂O]	[RPM]
CASB-350-2T-3	B	T	NO	1,02	60,7%	67,3	2,32	3006	171,40	2878
CASB-400-2T-5.5	B	T	NO	1,02	64,2%	68,7	3,75	3826	230,96	2903
CASB-450-2T-10 IE3	B	T	NO	1,03	68,7%	70,4	6,90	6156	282,49	2946
CASB-500-2T-15 IE3	B	T	NO	1,03	73,0%	72,9	11,58	9875	314,16	2951
CASB-500-4T-1.5	B	T	NO	1,01	63,8%	73,0	1,33	4592	67,93	1421
CASB-560-2T-20 IE3	B	T	NO	1,03	71,7%	71,3	15,61	11911	344,81	2952
CASB-560-2T-25 IE3	B	T	NO	1,04	73,2%	72,5	19,29	12502	414,47	2951
CASB-560-4T-3	B	T	NO	1,01	66,0%	72,3	2,52	6126	99,51	1447
CASB-630-2T-40 IE3	B	T	NO	1,05	71,0%	70,0	27,66	15475	465,88	2970
CASB-630-2T-50 IE3	B	T	NO	1,05	71,7%	70,4	33,90	16822	530,04	2970
CASB-630-4T-5.5	B	T	NO	1,01	65,9%	70,1	3,95	7990	119,59	1448
CASB-710-4T-7.5	B	T	NO	1,01	66,6%	69,7	5,05	9150	134,76	1468
CASB-710-4T-10 IE3	B	T	NO	1,01	70,2%	72,2	6,44	11028	150,27	1473
CASB-800-4T-15 IE3	B	T	NO	1,02	72,0%	72,1	10,33	15811	172,74	1474
CASB-800-4T-20 IE3	B	T	NO	1,02	74,3%	74,0	14,38	17743	221,10	1473
CASB-800-6T-5.5	B	T	NO	1,01	66,4%	70,6	4,01	11226	87,08	966
CASB-900-4T-30 IE3	B	T	NO	1,03	76,2%	75,4	21,53	22394	268,67	1473
CASB-900-4T-40 IE3	B	T	NO	1,03	74,9%	73,9	26,17	23547	305,41	1484
CASB-900-6T-10 IE3	B	T	NO	1,01	73,8%	74,8	7,95	15900	135,44	976
CASB-1000-4T-50 IE3	B	T	NO	1,03	74,8%	73,7	30,82	26615	318,03	1484
CASB-1000-4T-60 IE3	B	T	NO	1,03	78,3%	76,8	42,81	34463	356,87	1482
CASB-1000-6T-15 IE3	B	T	NO	1,01	72,2%	72,2	10,64	18444	152,73	978
CASB-1000-6T-20 IE3	B	T	NO	1,02	76,0%	75,6	14,62	23848	170,89	978
CASB-1120-4T-75 IE3	B	T	NO	1,04	82,0%	80,4	46,38	31367	444,85	1484
CASB-1120-4T-100 IE3	B	T	NO	1,04	76,9%	74,7	76,43	50764	424,80	1485
CASB-1120-6T-25 IE3	B	T	NO	1,02	79,6%	79,1	15,70	21643	211,79	984
CASB-1120-6T-30 IE3	B	T	NO	1,02	74,7%	73,9	22,61	33505	185,04	981
CASB-1250-4T-150 IE3	B	T	NO	1,05	77,9%	75,4	99,42	54704	519,41	1491
CASB-1250-4T-175 IE3	B	T	NO	1,06	78,0%	75,2	130,19	65064	572,53	1490
CASB-1250-6T-40 IE3	B	T	NO	1,02	76,0%	74,9	28,75	35886	223,52	986
CASB-1250-6T-50 IE3	B	T	NO	1,02	76,5%	75,1	37,63	43240	244,32	986
CASB-1400-6T-60 IE3	B	T	NO	1,03	75,6%	74,1	41,26	42249	270,82	991
CASB-1400-6T-100 IE3	B	T	NO	1,03	77,7%	75,6	67,97	59732	324,35	991

Dimensiones mm

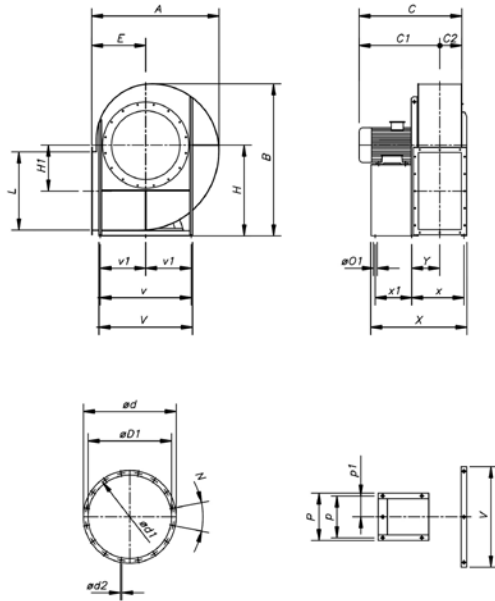

	A	B	C	C1	C2	D1	d	d1	d2	E	H	H1	L	N	O1	P	p	p1	V	v	v1	X	x	x1	Y
CASB-350-2T-3	595	745	530	425	105	285	379	332	10	255	450	253	288	8x45°	10	260	234	-	-	-	-	505	-	183	166
CASB-400-2T-5.5	660	830	630	500	130	320	412	366	10	285	500	286	322	8x45°	12	324	289	-	-	-	-	579	-	264	141
CASB-450-2T-10	745	930	670	527	143	360	450	405	10	320	560	321	361	8x45°	12	372	337	-	-	-	-	656	-	314	155
CASB-500-2T-15	830	1010	830	671	159	405	491	448	10	360	600	354	404	8x45°	14	440	395	-	-	-	-	798	-	414	176
CASB-500-4T-1.5	830	1010	615	456	159	405	491	448	10	360	600	354	404	8x45°	10	260	234	-	-	-	-	588	-	183	208
CASB-560-2T-20	950	1125	828	647	181	455	539	497	10	400	670	391	453	8x45°	14	440	395	-	672	632	-	851	386	414	193
CASB-560-2T-25	950	1125	828	647	181	455	539	497	10	400	670	391	453	12x30°	14	440	395	-	672	632	-	851	386	414	193
CASB-560-4T-3	950	1125	653	472	181	455	539	497	10	400	670	391	453	12x30°	12	324	289	-	672	632	-	676	381	249	188
CASB-630-2T-40	1075	1265	1023	823	200	505	597	551	10	450	750	441	507	12x30°	19	568	506	-	762	702	-	921	478	381	266
CASB-630-2T-50	1075	1265	1023	823	200	505	597	551	10	450	750	441	507	12x30°	19	568	506	-	762	702	-	921	478	381	266
CASB-630-4T-5.5	1075	1265	723	523	200	505	597	551	10	450	750	441	507	12x30°	12	324	289	-	762	702	-	731	421	264	209
CASB-710-4T-7.5	1190	1415	820	598	222	566	692	629	10	500	850	500	569	12x30°	19	836	772	386	896	772	386	826	497	263	262
CASB-710-4T-10	1190	1415	820	598	222	566	692	629	10	500	850	500	569	12x30°	19	836	772	386	896	772	386	826	497	263	262
CASB-800-4T-15	1330	1580	880	633	247	636	760	698	10	560	950	560	638	12x30°	19	926	862	431	986	862	431	875	546	263	287
CASB-800-4T-20	1330	1580	950	703	247	636	760	698	10	560	950	560	638	12x30°	19	926	862	431	986	862	431	984	546	372	287
CASB-800-6T-5.5	1330	1580	880	633	247	636	760	698	10	560	950	560	638	12x30°	19	926	862	431	986	862	431	875	546	263	287
CASB-900-4T-30	1490	1765	1115	837	278	716	834	775	12	630	1060	630	715	12x30°	19	1026	962	481	1086	962	481	1107	600	441	314
CASB-900-4T-40	1490	1765	1170	892	278	716	834	775	12	630	1060	630	715	12x30°	19	1026	962	481	1086	962	481	1067	600	401	314
CASB-900-6T-10	1490	1765	1010	732	278	716	834	775	12	630	1060	630	715	12x30°	19	1026	962	481	1086	962	481	1038	600	372	314
CASB-1000-4T-50	1675	1975	1260	950	310	806	916	861	12	710	1180	710	801	16x22,5°	19	1128	1056	528	1188	1056	528	1169	657	440	340
CASB-1000-4T-60	1675	1975	1260	950	310	806	916	861	12	710	1180	710	801	16x22,5°	19	1128	1056	528	1188	1056	528	1169	657	440	340
CASB-1000-6T-15	1675	1975	1130	820	310	806	916	861	12	710	1180	710	801	16x22,5°	19	1128	1056	528	1188	1056	528	1101	657	372	340
CASB-1000-6T-20	1675	1975	1170	860	310	806	916	861	12	710	1180	710	801	16x22,5°	19	1128	1056	528	1188	1056	528	1170	657	441	340
CASB-1120-4T-75	1885	2215	1490	1146	344	906	1010	958	12	800	1320	800	898	16x22,5°	24	1268	1178	589	1348	1178	589	1318	763	475	400
CASB-1120-4T-100	1885	2215	1540	1196	344	906	1010	958	12	800	1320	800	898	16x22,5°	24	1268	1178	589	1348	1178	589	1408	763	565	400
CASB-1120-6T-25	1885	2215	1320	976	344	906	1010	958	12	800	1320	800	898	16x22,5°	24	1268	1178	589	1348	1178	589	1218	763	375	400
CASB-1120-6T-30	1885	2215	1320	976	344	906	1010	958	12	800	1320	800	898	16x22,5°	24	1268	1178	589	1348	1178	589	1218	763	375	400
CASB-1250-4T-150	2080	2505	1620	1232	388	1007	1127	1067	12	900	1500	900	1007	16x22,5°	24	1400	1310	655	1480	1310	655	1611	840	691	438
CASB-1250-4T-175	2080	2505	1620	1232	388	1007	1127	1067	12	900	1500	900	1007	16x22,5°	24	1400	1310	655	1480	1310	655	1611	840	691	438
CASB-1250-6T-40	2080	2505	1370	982	388	1007	1127	1067	12	900	1500	900	1007	16x22,5°	24	1400	1310	655	1480	1310	655	1335	840	415	438
CASB-1250-6T-50	2080	2505	1470	1082	388	1007	1127	1067	12	900	1500	900	1007	24x15°	24	1400	1310	655	1480	1310	655	1395	840	475	438
CASB-1400-6T-60	2345	2815	1710	1279	431	1128	1272	1200	12	1000	1700	1000	1130	24x15°	24	1560	1450	725	1640	1450	725	1571	946	535	500
CASB-1400-6T-100	2345	2815	1720	1289	431	1128	1272	1200	12	1000	1700	1000	1130	24x15°	24	1560	1450	725	1640	1450	725	1681	946	645	500

Dimensiones mm

Boca impulsión

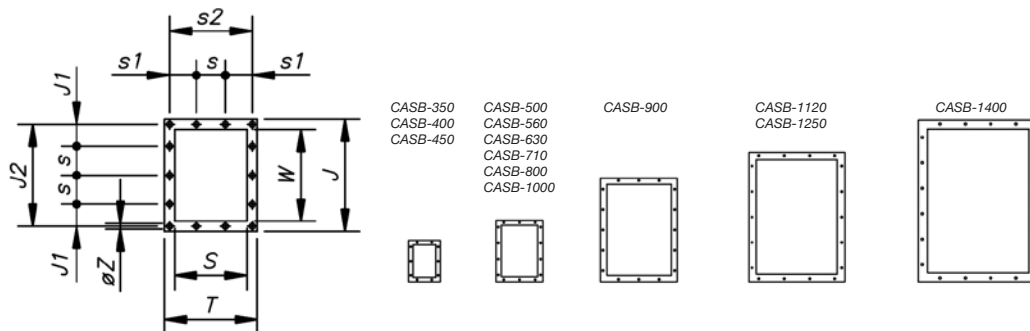

	T	J	J1	J2	S	s	s1	s2	W	ØZ
CASB-350-2T-3	285	368	41	332	205	125	62	249	288	12
CASB-400-2T-5.5	309	402	58	366	229	125	74	273	322	12
CASB-450-2T-10	336	441	77,5	405	256	125	87,5	300	361	12
CASB-500-2T-15	368	484	36,5	448	288	125	41	332	404	12
CASB-500-4T-1.5	368	484	36,5	448	288	125	41	332	404	12
CASB-560-2T-20	402	533	61	497	322	125	52,5	355	453	12
CASB-560-2T-25	402	533	61	497	322	125	52,5	355	453	12
CASB-560-4T-3	402	533	61	497	322	125	52,5	355	453	12
CASB-630-2T-40	441	587	88	551	361	125	77,5	405	507	12
CASB-630-2T-50	441	587	88	551	361	125	77,5	405	507	12
CASB-630-4T-5.5	441	587	88	551	361	125	77,5	405	507	12
CASB-710-4T-7.5	504	669	74,5	629	404	160	72	464	569	14
CASB-710-4T-10	504	669	74,5	629	404	160	72	464	569	14
CASB-800-4T-15	553	738	109	698	453	160	96,5	513	638	14
CASB-800-4T-20	553	738	109	698	453	160	96,5	513	638	14
CASB-800-6T-5.5	553	738	109	698	453	160	96,5	513	638	14
CASB-900-4T-30	607	815	67,5	775	507	160	123,5	567	715	14
CASB-900-4T-40	607	815	67,5	775	507	160	123,5	567	715	14
CASB-900-6T-10	607	815	67,5	775	507	160	123,5	567	715	14
CASB-1000-4T-50	689	921	135,5	871	569	200	119,5	639	801	14
CASB-1000-4T-60	689	921	135,5	871	569	200	119,5	639	801	14
CASB-1000-6T-15	689	921	135,5	871	569	200	119,5	639	801	14
CASB-1000-6T-20	689	921	135,5	871	569	200	119,5	639	801	14
CASB-1120-4T-75	758	1018	79	958	638	200	54	708	898	14
CASB-1120-4T-100	758	1018	79	958	638	200	54	708	898	14
CASB-1120-6T-25	758	1018	79	958	638	200	54	708	898	14
CASB-1120-6T-30	758	1018	79	958	638	200	54	708	898	14
CASB-1250-4T-150	835	1127	138,5	1077	715	200	92,5	785	1007	14
CASB-1250-4T-175	835	1127	138,5	1077	715	200	92,5	785	1007	14
CASB-1250-6T-40	835	1127	138,5	1077	715	200	92,5	785	1007	14
CASB-1250-6T-50	835	1127	138,5	1077	715	200	92,5	785	1007	14
CASB-1400-6T-60	941	1270	105	1210	801	200	140,5	881	1130	18
CASB-1400-6T-100	941	1270	105	1210	801	200	140,5	881	1130	18

**Curvas Características**

Q= Caudal en m³/h, m³/s y cfm

Pe= Presión estática en mmH₂O, Pa e inwg

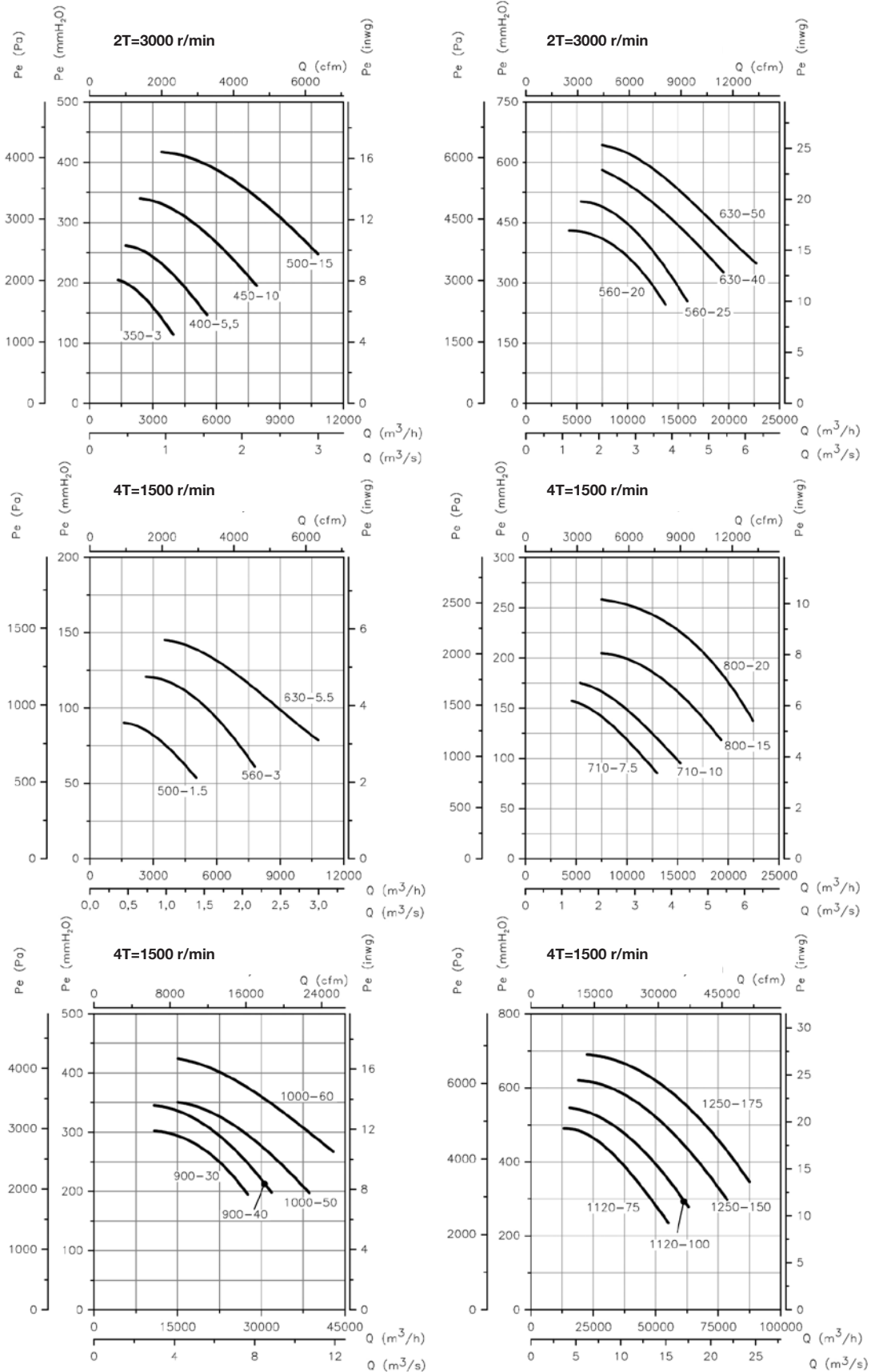



**Curvas Características**

Q= Caudal en m<sup>3</sup>/h, m<sup>3</sup>/s y cfm

Pe= Presión estática en mmH<sub>2</sub>O, Pa e inwg

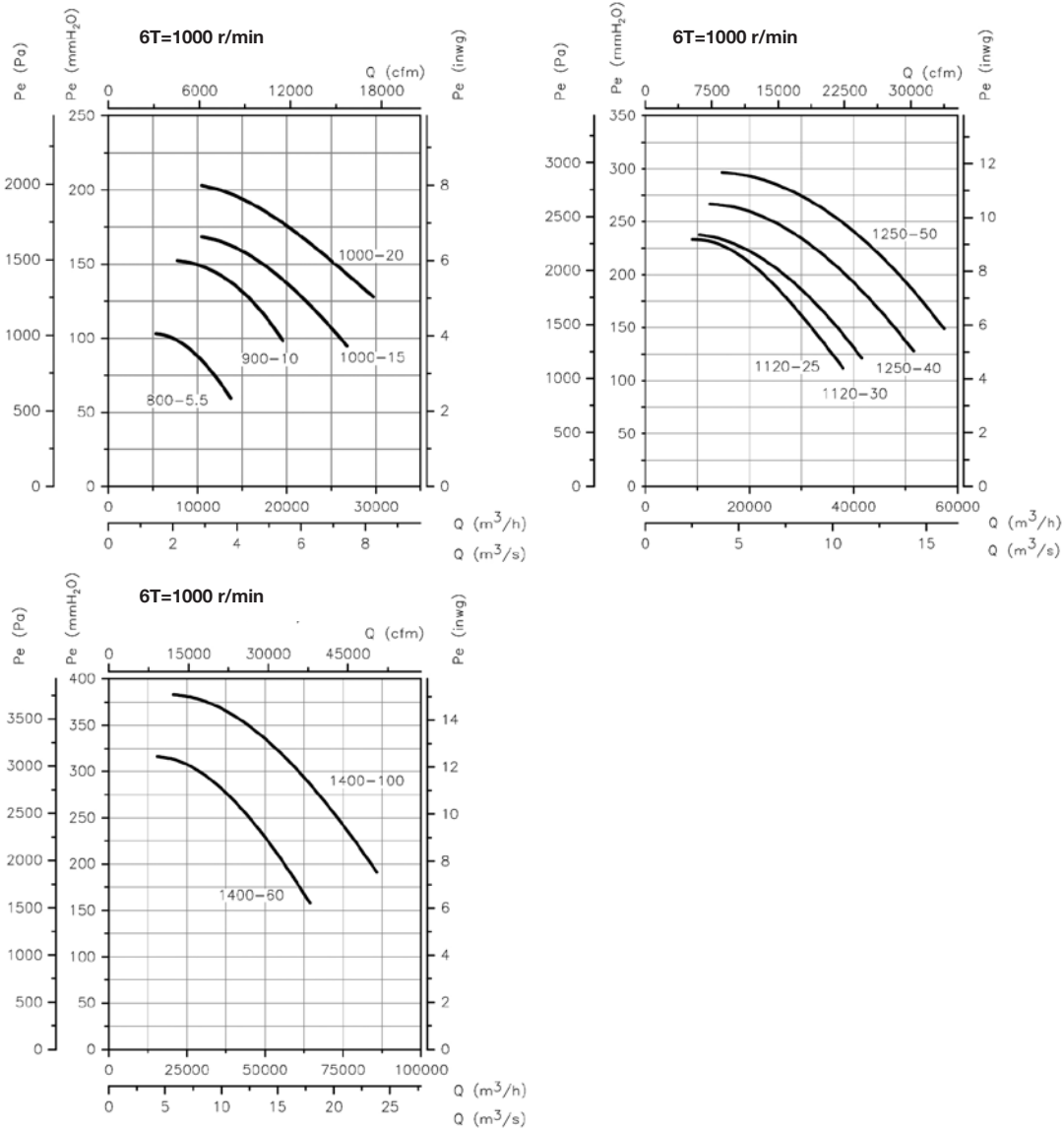

**Orientaciones**

Suministro estándar LG270, otras posiciones bajo demanda.  
 Modelos del 350 al 630 orientables. Medidas especiales en posiciones 180 y 225.  
 Modelos del 710 al 1400 no orientables. Medidas especiales excepto posición 315.

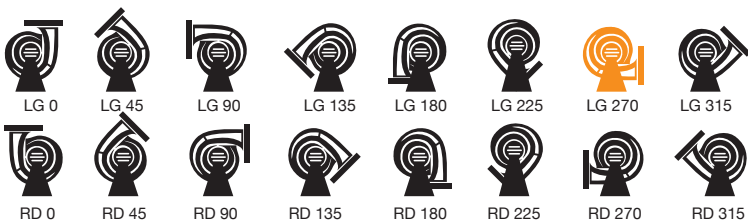

**Accesorios**

Ver apartado accesorios.



# CAB



## Ventiladores centrífugos de alta presión y simple aspiración de gran robustez, con envolvente y turbina en chapa de acero



### Ventilador:

- Envolvente en chapa de acero
- Turbina con álabes hacia atrás, en chapa de acero de gran robustez, especialmente diseñada para transportar aire limpio y aire polvoriento o ligeramente granulado
- Motor directamente acoplado

### Motor:

- Motores de eficiencia IE3 para potencias iguales o superiores a 7,5kW, excepto monofásicos, 2 velocidades y 8 polos
- Motores clase F, con rodamientos a bolas, protección IP55
- Trifásicos 230/400V-50Hz (hasta 4kW) y 400/690V-50Hz (potencias superiores a 4kW)
- Temperatura máxima del aire a transportar: -20°C + 120°C

### Acabado:

- Anticorrosivo en resina de poliéster polimerizada a 190 °C, previo desengrase con tratamiento nanotecnológico libre de fosfatos.

### Bajo demanda:

- Bobinados especiales para diferentes tensiones
- Ventilador preparado para transportar aire hasta 250°C
- Ventilador en acero inoxidable
- Certificación ATEX Categoría 2
- Motores de eficiencias IE2 e IE3 para cualquier potencia

### Código de pedido

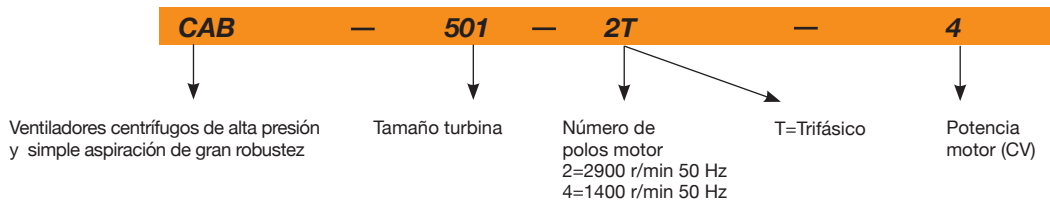

### Características técnicas

Modelo	Velocidad (r/min)	Intensidad máx admisible (A)			Potencia instalada (kW)	Caudal máximo (m³/h)	Nivel Presión Sonora dB(A)	Peso aprox (Kg)
		230 V	400 V	690 V				
CAB-501-2T-4	2880	10,30	5,92		3,00	1800	79	81
CAB-501-2T-5.5	2880	13,30	7,63		4,00	2905	80	93
CAB-561-2T-7.5	2910		10,60	6,14	5,50	2415	84	146
CAB-561-2T-10 IE3	2930		14,10	8,17	7,50	4210	85	143
CAB-562-2T-7.5	2910		10,60	6,14	5,50	3355	84	144
CAB-631-2T-15 IE3	2945		19,60	11,40	11,00	5025	87	211
CAB-632-2T-10 IE3	2930		14,10	8,17	7,50	3045	86	175
CAB-632-2T-15 IE3	2945		19,60	11,40	11,00	6055	87	201
CAB-712-2T-20 IE3	2945		33,90	19,70	18,50	5505	88	333
CAB-712-2T-25 IE3	2950		39,70	23,00	22,00	7075	90	413
CAB-711-2T-25 IE3	2945		27,70	16,10	15,00	5050	89	272
CAB-711-2T-30 IE3	2945		33,90	19,70	18,50	6715	89	285
CAB-801-2T-40 IE3	2960		54,50	31,60	30,00	7300	91	467
CAB-801-2T-50 IE3	2960		67,80	39,30	37,00	9775	91	467

**Características técnicas**

Modelo	Velocidad (r/min)	Intensidad máx admisible (A)			Potencia instalada (kW)	Caudal máximo (m³/h)	Nivel Presión Sonora dB(A)	Peso aprox (Kg)
		230 V	400 V	690 V				
CAB-801-2T-60 IE3	2960		77,50	44,90	45,00	13150	91	603
CAB-802-2T-40 IE3	2960		54,50	31,60	30,00	8220	91	437
CAB-802-2T-50 IE3	2960		67,80	39,30	37,00	11190	92	462
CAB-901-2T-75 IE3	2960		95,60	55,40	55,00	10430	94	713
CAB-901-2T-100 IE3	2965		128,00	74,20	75,00	14935	93	808
CAB-901-4T-10 IE3	1460		13,90	8,06	7,50	6000	80	317
CAB-902-2T-60 IE3	2960		77,50	44,90	45,00	9500	93	640
CAB-902-2T-75 IE3	2960		95,60	55,40	55,00	12550	93	703
CAB-902-2T-100 IE3	2965		128,00	74,20	75,00	16785	92	798



**Erp. Características del punto de máxima eficiencia (BEP)**

<b>MC</b>	Categoría de medición	<b>ηe[%]</b>	Eficiencia
<b>EC</b>	Categoría de eficiencia	<b>N</b>	Grado de eficiencia
<b>S</b>	Estática	<b>[kW]</b>	Potencia eléctrica
<b>T</b>	Total	<b>[m³/h]</b>	Caudal
<b>VSD</b>	Variador de velocidad	<b>[mmH₂O]</b>	Presión estática o total (Según EC)
<b>SR</b>	Relación específica	<b>[RPM]</b>	Velocidad

Modelo	MC	EC	VSD	SR	ηe [%]	N	[kW]	[m3/h]	[mmH₂O]	[RPM]
CAB-501-2T-4	B	T	NO	1,05	67,5%	72,3	3,546	1800	488,31	2880
CAB-501-2T-5.5	B	T	NO	1,05	69,7%	74,1	3,859	2098	470,78	2900
CAB-561-2T-7.5	B	T	NO	1,06	69,0%	71,1	6,322	2416	662,40	2910
CAB-561-2T-10 IE3	B	T	NO	1,06	72,4%	74,3	6,636	2690	655,57	2944
CAB-562-2T-7.5	B	T	NO	1,05	72,8%	75,0	6,138	3354	489,06	2913
CAB-631-2T-15 IE3	B	T	NO	1,08	80,3%	80,3	11,275	4259	780,60	2948
CAB-632-2T-10 IE3	B	T	NO	1,07	75,7%	76,5	8,260	3044	753,31	2930
CAB-632-2T-15 IE3	B	T	NO	1,07	79,3%	79,4	10,118	4227	696,77	2954
CAB-712-2T-20 IE3	B	T	NO	1,10	76,0%	75,3	20,916	5908	987,94	2942
CAB-712-2T-25 IE3	B	T	NO	1,10	76,4%	75,6	21,506	5964	1010,57	2955
CAB-711-2T-25 IE3	B	T	NO	1,09	76,2%	75,7	16,268	5047	901,35	2945
CAB-711-2T-30 IE3	B	T	NO	1,08	78,9%	78,2	19,093	6714	822,92	2947
CAB-801-2T-40 IE3	-	-	-	1,12	-	-	32,848	7569	1242,33	2959
CAB-801-2T-50 IE3	-	-	-	1,12	-	-	33,678	7640	1265,95	2966
CAB-801-2T-60 IE3	-	-	-	1,13	-	-	34,601	7722	1292,44	2971
CAB-802-2T-40 IE3	-	-	-	1,12	-	-	13,819	3314	1223,88	2983
CAB-802-2T-50 IE3	-	-	-	1,12	-	-	13,991	3331	1236,54	2986
CAB-901-2T-75 IE3	-	-	-	1,16	-	-	61,994	11509	1606,22	2957
CAB-901-2T-100 IE3	-	-	-	1,16	-	-	64,313	11674	1651,43	2972
CAB-901-4T-10 IE3	B	T	NO	1,04	74,4%	75,8	7,282	5293	375,52	1465
CAB-902-2T-60 IE3	-	-	-	1,14	-	-	51,086	10595	1438,25	2957
CAB-902-2T-75 IE3	-	-	-	1,14	-	-	52,812	10712	1470,68	2964
CAB-902-2T-100 IE3	-	-	-	1,15	-	-	54,036	10813	1498,56	2976

Dimensiones mm

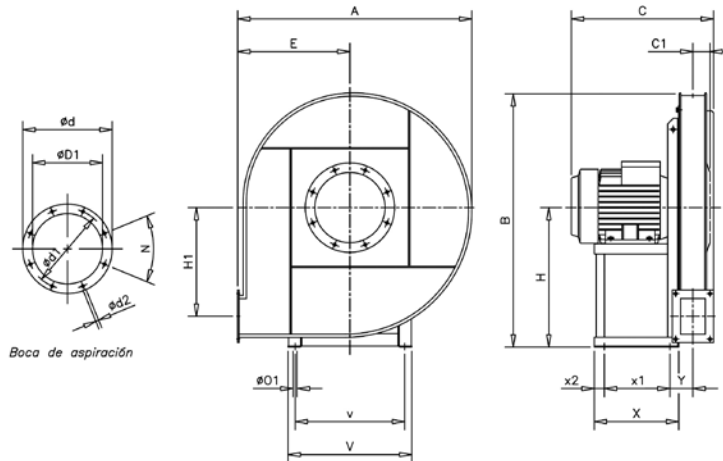

	A	B	C	C1	E	H	H1	ØD1	V	v	X	x1	x2	Y	ØD1	Ød	Ød1	Ød2	N
CAB-501-2T-4	735	800	500	77	355	450	310	12	332	300	260	200	25	104	205	275	241	11,5	8x45°
CAB-501-2T-5.5	735	800	500	77	355	450	310	12	332	300	260	200	25	104	205	275	241	11,5	8x45°
CAB-561-2T-7.5	830	895	595	87	400	500	350	12	392	360	320	250	25	122	229	299	265	11,5	8x45°
CAB-561-2T-10	830	895	595	87	400	500	350	12	392	360	320	250	25	122	229	299	265	11,5	8x45°
CAB-562-2T-7.5	830	895	595	87	400	500	350	12	392	360	320	250	25	122	229	299	265	11,5	8x45°
CAB-631-2T-15	900	990	750	100	425	560	388	14	440	400	425	340	30	142	255	325	292	11,5	8x45°
CAB-632-2T-10	900	990	610	100	425	560	388	14	440	400	425	340	30	142	255	325	292	11,5	8x45°
CAB-632-2T-15	900	990	750	100	425	560	388	14	440	400	425	340	30	142	255	325	292	11,5	8x45°
CAB-711-2T-25	1005	1115	780	110	475	630	435	14	440	400	425	340	30	152	286	366	332	11,5	8x45°
CAB-711-2T-30	1005	1115	780	110	475	630	435	14	440	400	425	340	30	152	286	366	332	11,5	8x45°
CAB-712-2T-20	1005	1115	780	110	475	630	435	14	440	400	425	340	30	152	286	366	332	11,5	8x45°
CAB-712-2T-25	1005	1115	780	110	475	630	435	14	440	400	425	340	30	152	286	366	332	11,5	8x45°
CAB-801-2T-40	1120	1250	875	120	530	710	490	16	570	510	500	385	40	183	321	401	366	11,5	8x45°
CAB-801-2T-50	1120	1250	875	120	530	710	490	16	570	510	500	385	40	183	321	401	366	11,5	8x45°
CAB-801-2T-60	1120	1250	875	120	530	710	490	16	570	510	500	385	40	183	321	401	366	11,5	8x45°
CAB-802-2T-40	1120	1250	875	120	530	710	490	16	570	510	500	385	40	183	321	401	366	11,5	8x45°
CAB-802-2T-50	1120	1250	875	120	530	710	490	16	570	510	500	385	40	183	321	401	366	11,5	8x45°
CAB-901-2T-75	1265	1410	990	135	600	800	552	21	686	615	600	460	45	217	361	486	405	11,5	8x45°
CAB-901-2T-100	1265	1410	1120	135	600	800	552	21	760	690	700	550	50	222	361	486	405	11,5	8x45°
CAB-901-4T-10	1265	1410	700	135	600	800	552	12	392	360	320	250	25	167	361	486	405	11,5	8x45°
CAB-902-2T-60	1265	1410	980	135	600	800	552	19	626	565	550	425	40	207	361	486	405	11,5	8x45°
CAB-902-2T-75	1265	1410	990	135	600	800	552	21	698	615	600	550	45	217	361	486	405	11,5	8x45°
CAB-902-2T-100	1265	1410	1120	135	600	800	552	21	760	680	700	550	50	222	361	486	405	11,5	8x45°

Dimensiones mm

Boca impulsión

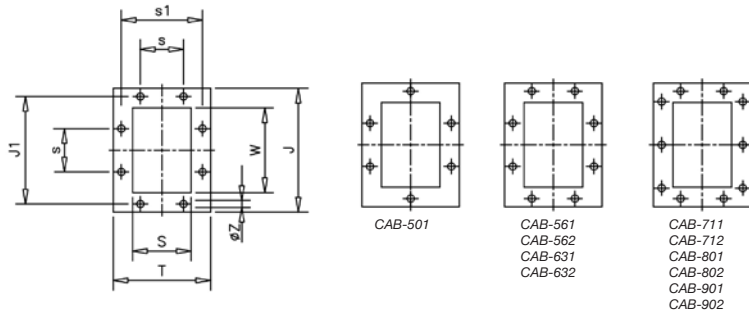

	T	J	J1	S	s	s1	W	ØZ
CAB-501-2T-4	195	250	219	125	112	167	180	11,5
CAB-501-2T-5.5	195	250	219	125	112	167	180	11,5
CAB-561-2T-7.5	210	270	241	140	112	182	200	11,5
CAB-561-2T-10	210	270	241	140	112	182	200	11,5
CAB-562-2T-7.5	210	270	241	140	112	182	200	11,5
CAB-631-2T-15	230	294	265	160	112	200	224	11,5
CAB-632-2T-10	230	294	265	160	112	200	224	11,5
CAB-632-2T-15	230	294	265	160	112	200	224	11,5
CAB-711-2T-25	250	320	292	180	112	219	250	11,5
CAB-711-2T-30	250	320	292	180	112	219	250	11,5
CAB-712-2T-20	250	320	292	180	112	219	250	11,5
CAB-712-2T-25	250	320	292	180	112	219	250	11,5
CAB-801-2T-40	280	360	332	200	125	249	280	11,5
CAB-801-2T-50	280	360	332	200	125	249	280	11,5
CAB-801-2T-60	280	360	332	200	125	249	280	11,5
CAB-802-2T-40	280	360	332	200	125	249	280	11,5
CAB-802-2T-50	280	360	332	200	125	249	280	11,5
CAB-901-2T-75	304	395	366	224	125	273	315	11,5
CAB-901-2T-100	304	395	366	224	125	273	315	11,5
CAB-901-4T-10	304	395	366	224	125	273	315	11,5
CAB-902-2T-60	304	395	366	224	125	273	315	11,5
CAB-902-2T-75	304	395	366	224	125	273	315	11,5
CAB-902-2T-100	304	395	366	224	125	273	315	11,5

**Curvas Características**

Q= Caudal en m<sup>3</sup>/h, m<sup>3</sup>/s y cfm

Pe= Presión estática en mmH<sub>2</sub>O, Pa e inwg

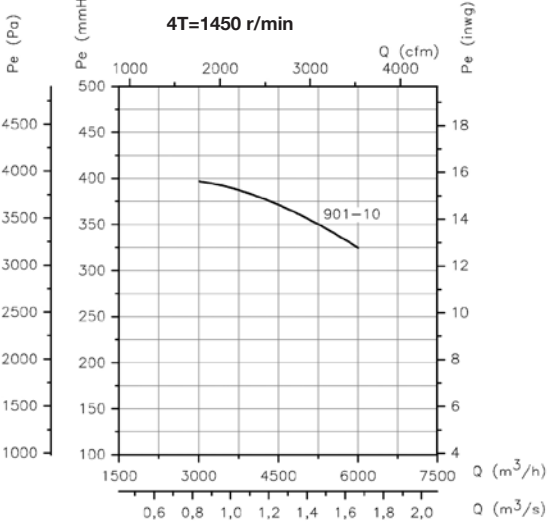
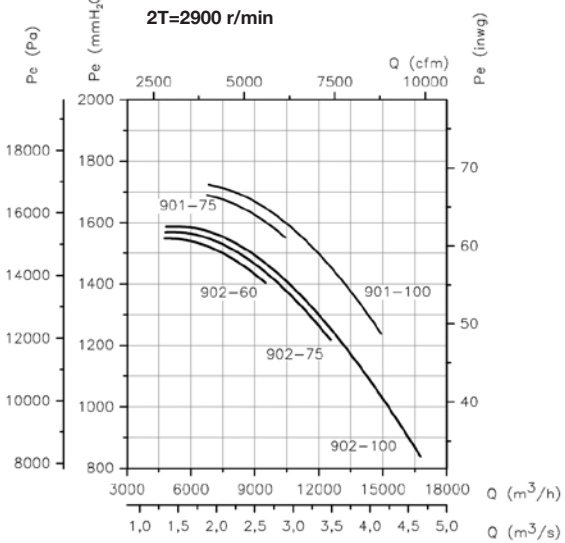
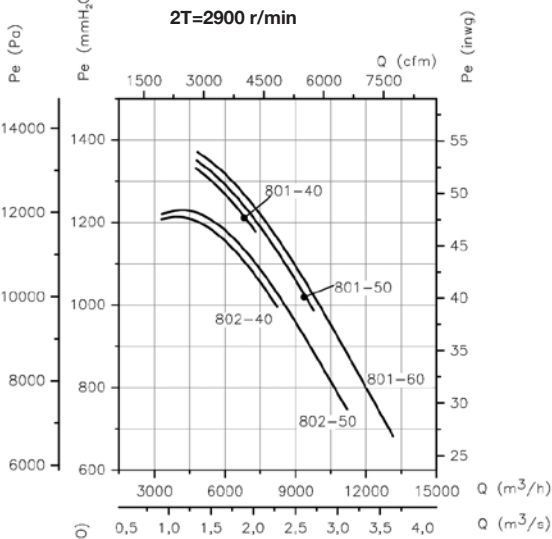
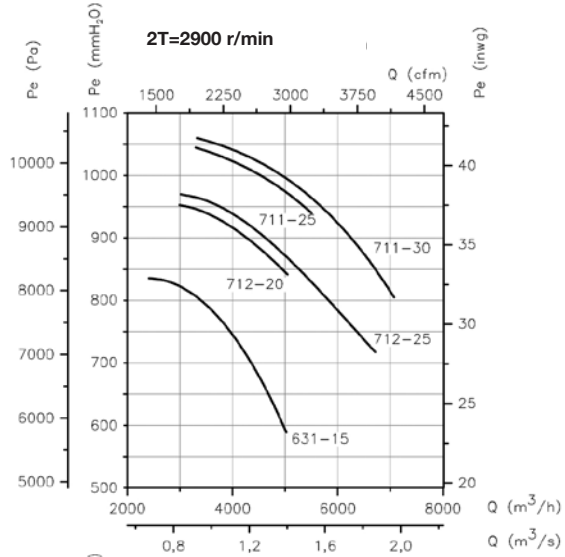
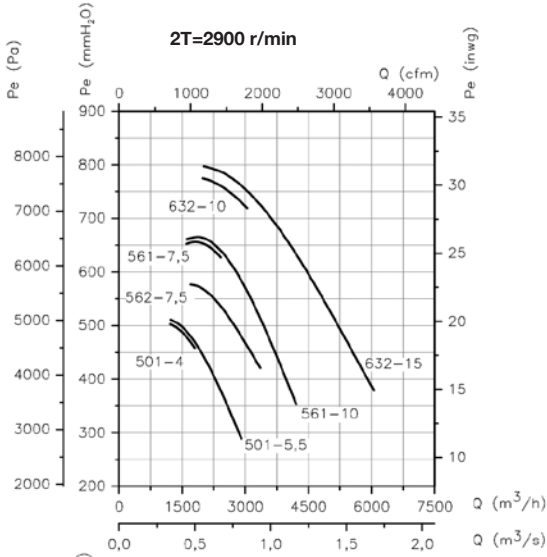

**Orientaciones**

Suministro estándar LG270, otras posiciones bajo demanda.  
Modelos del 501 al 802 orientables. Medidas especiales en posiciones 180 y 225.  
Modelos 901 y 902 orientables. Medidas especiales excepto posición 315.

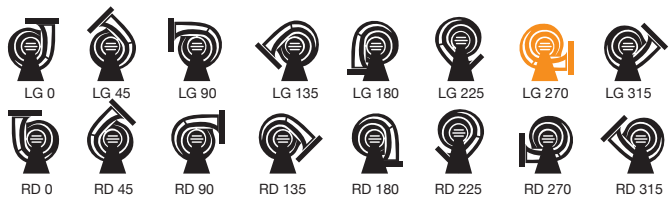

# CMRS-X

**Ventiladores accionados a transmisión, equipados con motor eléctrico, conjunto de poleas, correas y protectores normalizados según norma ISO-13857:2008**



Construcción de gran robustez

**Ventilador:**

- Envoltura en chapa de acero
- Turbina con álabes a reacción, en chapa de acero de gran robustez, especialmente diseñada para transportar aire limpio o ligeramente polvoriento
- Motor montado sobre bancada general
- Ventilador accionado a transmisión

**Motor:**

- Motores eficiencia IE3
- Motores clase F, con rodamientos a bolas, protección IP55
- Trifásicos 230/400V-50Hz (hasta 4kW) y 400/690V-50Hz (potencias superiores a 4kW)
- Temperatura máxima del aire a transportar: -20°C + 150°C

polimerizada a 190 °C, previo desengrase con tratamiento nanotecnológico libre de fosfatos.

**Bajo demanda:**

- Bobinados especiales para diferentes tensiones
- Ventilador preparado para transportar aire hasta 250°C
- Ventilador en acero inoxidable
- Certificación ATEX Categoría 2
- Motores eficiencia IE2

**Acabado:**

- Anticorrosivo en resina de poliéster

## Código de pedido

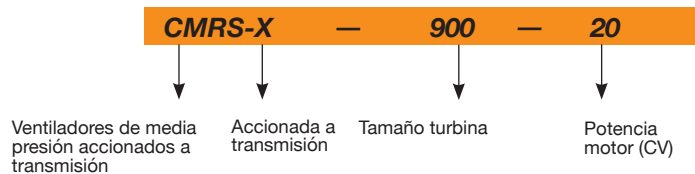

## Características técnicas

Modelo	Velocidad (r/min)	Intensidad máx admisible (A)		Potencia instalada (kW)	Caudal máximo (m3/h)	Presión máxima (mm H <sub>2</sub> O)	Peso aprox (Kg)
		400 V	690 V				
CMRS-X-800-10 IE3	940	14,00	8,10	7,50	32250	105	442
CMRS-X-800-15 IE3	1060	21,00	12,10	11,00	36350	130	480
CMRS-X-800-20 IE3	1200	28,10	16,20	15,00	41150	170	496
CMRS-X-800-25 IE3	1290	35,20	20,30	18,50	44250	195	535
CMRS-X-800-30 IE3	1370	41,20	23,80	22,00	46950	220	558
CMRS-X-900-20 IE3	1130	28,10	16,20	15,00	48250	170	681
CMRS-X-900-25 IE3	1200	35,20	20,30	18,50	51250	190	720
CMRS-X-900-30 IE3	1280	41,20	23,80	22,00	54700	220	743
CMRS-X-900-40 IE3	1430	57,30	33,10	30,00	61100	270	793
CMRS-X-900-50 IE3	1520	69,10	39,90	37,00	64950	310	910
CMRS-X-900-60 IE3	1630	81,20	46,90	45,00	69650	355	942
CMRS-X-1000-30 IE3	1050	41,20	23,80	22,00	63500	185	1152
CMRS-X-1000-40 IE3	1165	57,30	33,10	30,00	70450	230	1202
CMRS-X-1000-50 IE3	1250	69,10	39,90	37,00	75600	260	1319
CMRS-X-1000-60 IE3	1340	81,20	46,90	45,00	81050	300	1351
CMRS-X-1000-75 IE3	1430	99,10	57,20	55,00	86500	345	1429
CMRS-X-1000-100 IE3	1525	131,50	75,90	75,00	92250	390	1704
CMRS-X-1120-30 IE3	880	41,20	23,80	22,00	73900	165	933
CMRS-X-1120-40 IE3	970	57,30	33,10	30,00	81500	200	983
CMRS-X-1120-50 IE3	1040	69,10	39,90	37,00	87350	230	1100
CMRS-X-1120-60 IE3	1110	81,20	46,90	45,00	93250	265	1132
CMRS-X-1120-75 IE3	1180	99,10	57,20	55,00	99100	295	1210
CMRS-X-1120-100 IE3	1310	131,50	75,90	75,00	110050	365	1485
CMRS-X-1250-40 IE3	800	57,30	33,10	30,00	96000	170	1358
CMRS-X-1250-50 IE3	860	69,10	39,90	37,00	103200	195	1475
CMRS-X-1250-60 IE3	920	81,20	46,90	45,00	110400	225	1507
CMRS-X-1250-75 IE3	980	99,10	57,20	55,00	117600	255	1585
CMRS-X-1250-100 IE3	1090	131,50	75,90	75,00	130800	315	1860
CMRS-X-1250-125 IE3	1160	158,70	91,60	90,00	139200	355	1927
CMRS-X-1400-50 IE3	690	69,10	39,90	37,00	113850	160	2023

**Características técnicas**

Modelo	Velocidad (r/min)	Intensidad máx admisible (A)		Potencia instalada (kW)	Caudal máximo (m3/h)	Presión máxima (mm H <sub>2</sub> O)	Peso aprox (Kg)
		400 V	690 V				
CMRS-X-1400-60 IE3	740	81,20	46,90	45,00	12100	180	2055
CMRS-X-1400-75 IE3	790	99,10	57,20	55,00	130350	210	2133
CMRS-X-1400-100 IE3	875	131,50	75,90	75,00	144400	255	2408
CMRS-X-1400-125 IE3	930	158,70	91,60	90,00	153450	290	2475
CMRS-X-1400-150 IE3	1000	194,00	112,00	110,00	165000	335	2538
CMRS-X-1600-75 IE3	680	99,10	57,20	55,00	145850	195	2590
CMRS-X-1600-100 IE3	750	131,50	75,90	75,00	160900	240	2865
CMRS-X-1600-125 IE3	800	158,70	91,60	90,00	171600	270	2932
CMRS-X-1600-150 IE3	860	194,00	112,00	110,00	184450	315	2995
CMRS-X-1600-175 IE3	910	232,10	134,00	132,00	195200	350	3067
CMRS-X-1600-220 IE3	970	280,60	162,00	160,00	208050	400	3140



**Erp. Características del punto de máxima eficiencia (BEP)**

<b>MC</b>	Categoría de medición	<b>ηe [%]</b>	Eficiencia
<b>EC</b>	Categoría de eficiencia	<b>N</b>	Grado de eficiencia
<b>S</b>	Estática	<b>[kW]</b>	Potencia eléctrica
<b>T</b>	Total	<b>[m³/h]</b>	Caudal
<b>VSD</b>	Variador de velocidad	<b>[mmH<sub>2</sub>O]</b>	Presión estática o total (Según EC)
<b>SR</b>	Relación específica	<b>[RPM]</b>	Velocidad

Modelo	MC	EC	VSD	SR	ηe [%]	N	[kW]	[m3/h]	[mmH <sub>2</sub> O]	[RPM]
CMRS-X-800-10 IE3	C	S	NO	1,01	64,1%	66,5	5,964	15178	92,47	940
CMRS-X-800-15 IE3	C	S	NO	1,01	64,6%	65,3	8,496	17116	117,59	1060
CMRS-X-800-20 IE3	C	S	NO	1,02	65,3%	65,2	12,180	19377	150,70	1200
CMRS-X-800-25 IE3	C	S	NO	1,02	65,3%	64,9	15,131	20830	174,15	1290
CMRS-X-800-30 IE3	C	S	NO	1,02	65,4%	64,8	18,104	22122	196,42	1370
CMRS-X-900-20 IE3	C	S	NO	1,02	68,6%	68,2	15,265	24913	154,35	1130
CMRS-X-900-25 IE3	C	S	NO	1,02	69,0%	68,4	18,183	26456	174,06	1200
CMRS-X-900-30 IE3	C	S	NO	1,02	69,3%	68,5	21,973	28220	198,04	1280
CMRS-X-900-40 IE3	C	S	NO	1,03	69,7%	68,5	30,475	31527	247,18	1430
CMRS-X-900-50 IE3	C	S	NO	1,03	70,3%	68,9	36,289	33511	279,27	1520
CMRS-X-900-60 IE3	C	S	NO	1,03	70,2%	68,6	44,798	35936	321,16	1630
CMRS-X-1000-30 IE3	C	S	NO	1,02	67,2%	66,3	22,440	34574	159,98	1050
CMRS-X-1000-40 IE3	C	S	NO	1,02	67,5%	66,4	30,487	38361	196,94	1165
CMRS-X-1000-50 IE3	C	S	NO	1,02	68,1%	66,7	37,340	41160	226,73	1250
CMRS-X-1000-60 IE3	C	S	NO	1,03	68,0%	66,4	46,049	44123	260,55	1340
CMRS-X-1000-75 IE3	C	S	NO	1,03	68,2%	66,4	55,788	47087	296,73	1430
CMRS-X-1000-100 IE3	C	S	NO	1,03	68,6%	66,6	67,306	50215	337,46	1525
CMRS-X-1120-30 IE3	C	S	NO	1,01	67,6%	66,7	23,539	40277	144,94	880
CMRS-X-1120-40 IE3	C	S	NO	1,02	67,9%	66,8	31,357	44396	176,11	970
CMRS-X-1120-50 IE3	C	S	NO	1,02	68,5%	67,1	38,321	47600	202,44	1040
CMRS-X-1120-60 IE3	C	S	NO	1,02	68,5%	66,8	46,640	50804	230,61	1110
CMRS-X-1120-75 IE3	C	S	NO	1,03	68,7%	66,8	55,855	54008	260,61	1180
CMRS-X-1120-100 IE3	C	S	NO	1,03	69,0%	66,9	76,022	59958	321,20	1310
CMRS-X-1250-40 IE3	C	S	NO	1,02	69,0%	67,9	29,183	50208	147,26	800
CMRS-X-1250-50 IE3	C	S	NO	1,02	69,6%	68,3	35,947	53973	170,17	860
CMRS-X-1250-60 IE3	C	S	NO	1,02	69,6%	68,0	44,054	57739	194,75	920
CMRS-X-1250-75 IE3	C	S	NO	1,02	69,8%	68,0	53,079	61505	220,98	980
CMRS-X-1250-100 IE3	C	S	NO	1,03	70,1%	68,0	72,650	68408	273,37	1090
CMRS-X-1250-125 IE3	C	S	NO	1,03	70,3%	68,0	87,382	72801	309,61	1160
CMRS-X-1400-50 IE3	C	S	NO	1,02	68,8%	67,6	32,226	54594	149,04	690
CMRS-X-1400-60 IE3	C	S	NO	1,02	68,7%	67,3	39,794	58550	171,42	740
CMRS-X-1400-75 IE3	C	S	NO	1,02	68,9%	67,3	48,264	62506	195,37	790
CMRS-X-1400-100 IE3	C	S	NO	1,02	69,3%	67,3	65,234	69231	239,67	875
CMRS-X-1400-125 IE3	C	S	NO	1,03	69,5%	67,3	78,161	73583	270,75	930
CMRS-X-1400-150 IE3	C	S	NO	1,03	69,6%	67,2	96,969	79121	313,04	1000
CMRS-X-1600-75 IE3	C	S	NO	1,02	71,6%	69,8	55,669	90083	162,46	680
CMRS-X-1600-100 IE3	C	S	NO	1,02	72,0%	69,9	74,299	99356	197,62	750
CMRS-X-1600-125 IE3	C	S	NO	1,02	72,2%	69,8	89,983	105980	224,85	800
CMRS-X-1600-150 IE3	C	S	NO	1,03	72,3%	69,7	111,552	113929	259,84	860
CMRS-X-1600-175 IE3	C	S	NO	1,03	72,5%	69,7	131,886	120552	290,94	910
CMRS-X-1600-220 IE3	C	S	NO	1,03	72,6%	69,6	159,398	128501	330,57	970



Dimensiones mm

CMRS-X-800

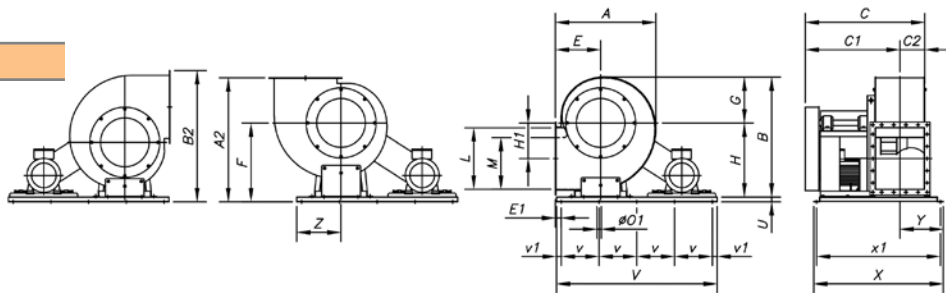

Modelo	A	A2	B	B2	C	C1	C2	E	E1	F	G	H	H1	L	M	øO1	U	V	v	v1	X	x1	Y	Z
CMRS-X-800	1487	1530	1722	1883	1318	1031	287	680	75	850	850	1050	410	1120	710	14	80	1900	450	50	1420	1360	440	508

CMRS-X-900...1600

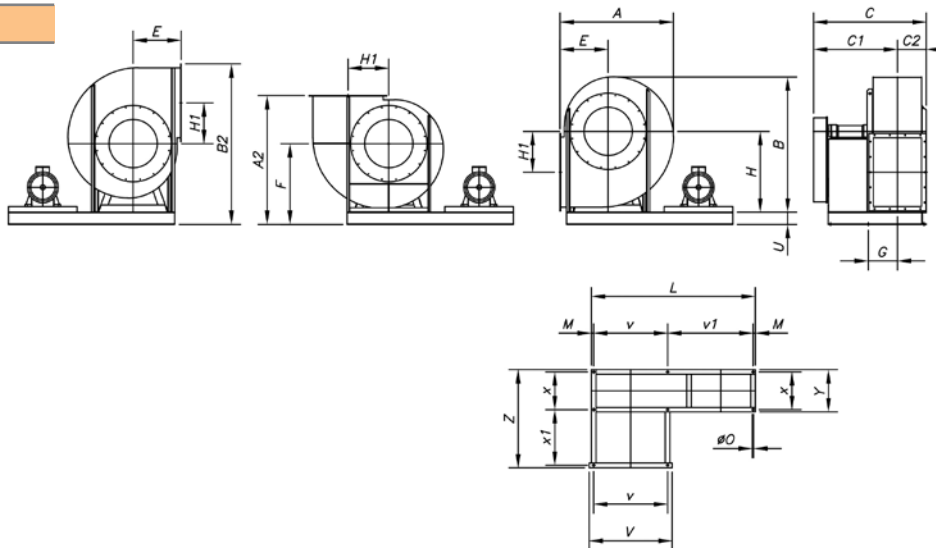

Modelo	A	A2	B	B2	C	C1	C2	E	F	G	H	H1	L	M	øO	U	V	v	v1	x	x1	Y	Z
CMRS-X-900	1495	1690	1785	2110	1470	1090	320,5	630	1060	383	1060	535	2150	30	19	160	1090	970	1120	495	731	555	1286
CMRS-X-1000	1680	1890	1990	2360	1695	1274	362	710	1180	429	1180	610	2250	35	21	180	1190	1060	1120	600	818	660	1478
CMRS-X-1120	1890	2100	2230	2630	1805	1321	407	800	1300	469	1320	690	2390	35	24	180	1350	1200	1120	600	908	670	1578
CMRS-X-1250	2010	2260	2480	2910	1985	1451	462	830	1430	529	1500	775	2520	40	24	180	1480	1320	1120	670	1023	750	1773
CMRS-X-1400	2270	2450	2750	2950	2190	1606	512	950	1500	599	1650	860	2700	40	24	180	1660	1500	1120	750	1143	830	1973
CMRS-X-1600	2535	2740	3075	3265	2390	1746	572	1060	1680	654	1850	945	2900	40	24	180	1860	1700	1120	800	1258	880	2138

Dimensiones mm

Boca de aspiración

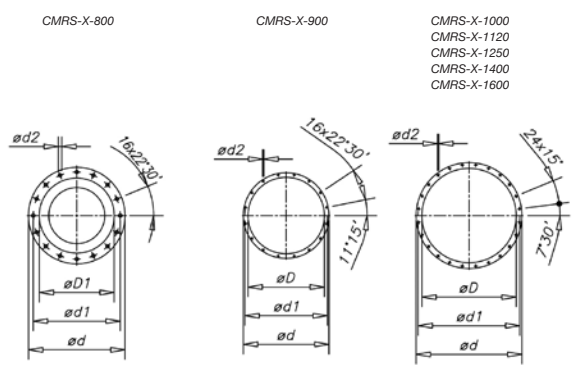

Boca de impulsión

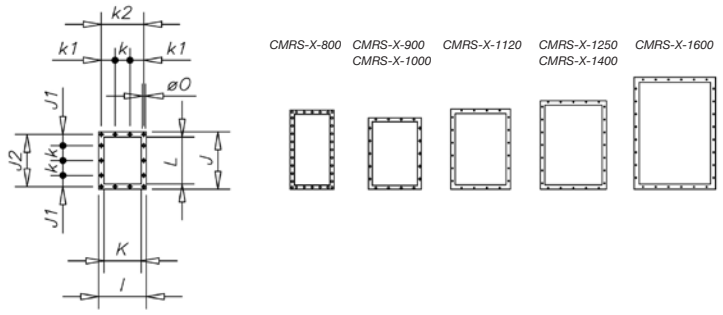

Modelo	øD1*	ød	ød1	ød2	I	J	J1	J2	K	k	k1	k2	L	øO
CMRS-X-800	800	910	861	M12	690	1246	93	1186	562	125	62,5	625	1122	13
CMRS-X-900	908	1008	958	14	750	1020	-	968	630	200	-	708	900	14
CMRS-X-1000	1008	1108	1067	14	830	1120	-	1077	710	200	-	785	1000	14
CMRS-X-1120	1130	1250	1200	14	940	1260	-	1210	800	200	-	881	1120	18
CMRS-X-1250	1260	1380	1337	14	1040	1390	-	1347	900	200	-	978	1250	18
CMRS-X-1400	1420	1540	1491	16	1160	1560	-	1501	1000	200	-	1087	1400	18
CMRS-X-1600	1610	1730	1663	16	1280	1760	-	1683	1120	200	-	1220	1600	22

\* Diámetro nominal tubería recomendada

**Curvas Características**

Q= Caudal en m<sup>3</sup>/h, m<sup>3</sup>/s y cfm

Pe= Presión estática en mmH<sub>2</sub>O, Pa e inwg

**CMRS-X 800**

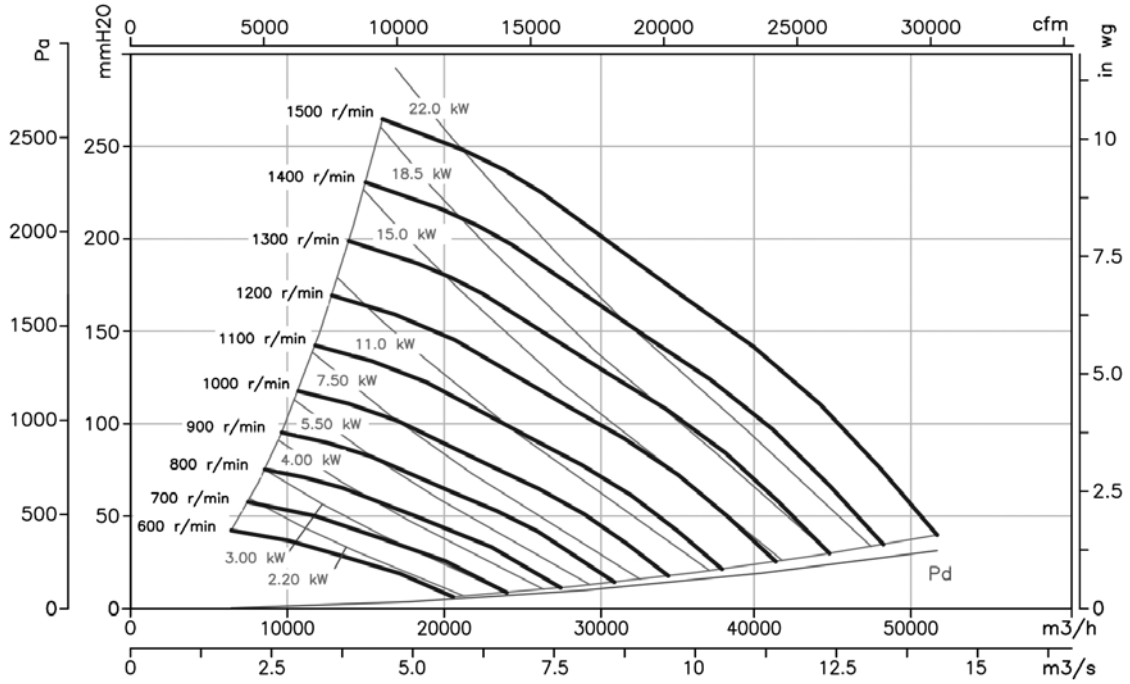

**CMRS-X 900**

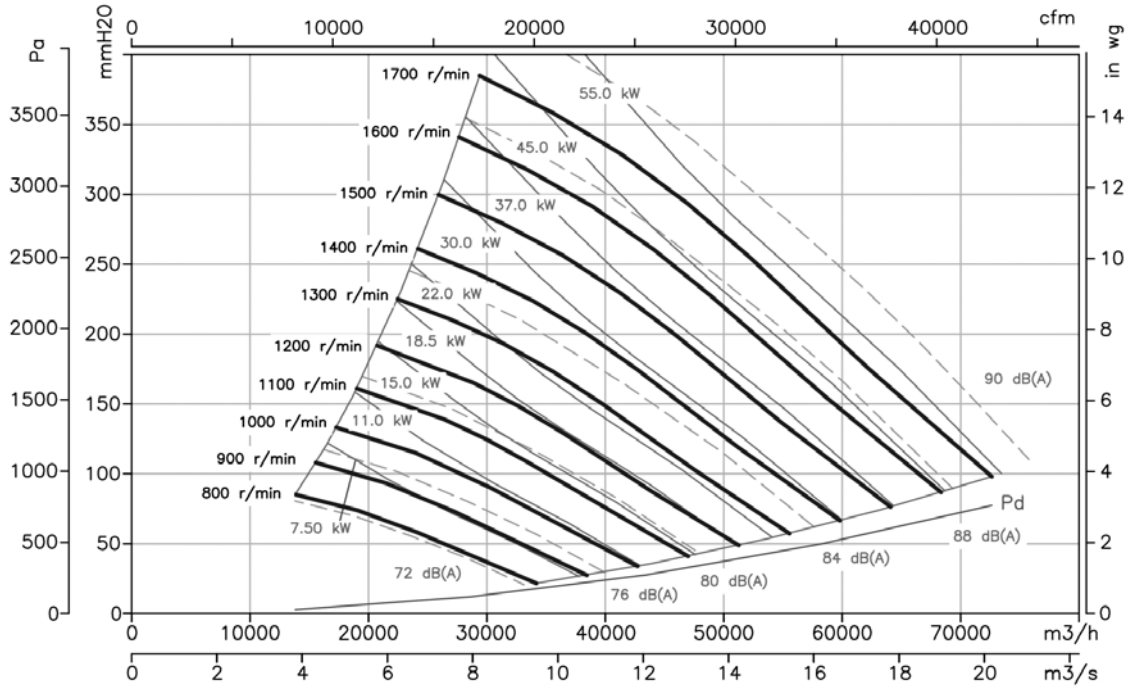

**Curvas Características**

Q= Caudal en m<sup>3</sup>/h, m<sup>3</sup>/s y cfm

Pe= Presión estática en mmH<sub>2</sub>O, Pa e inwg

**CMRS-X 1000**

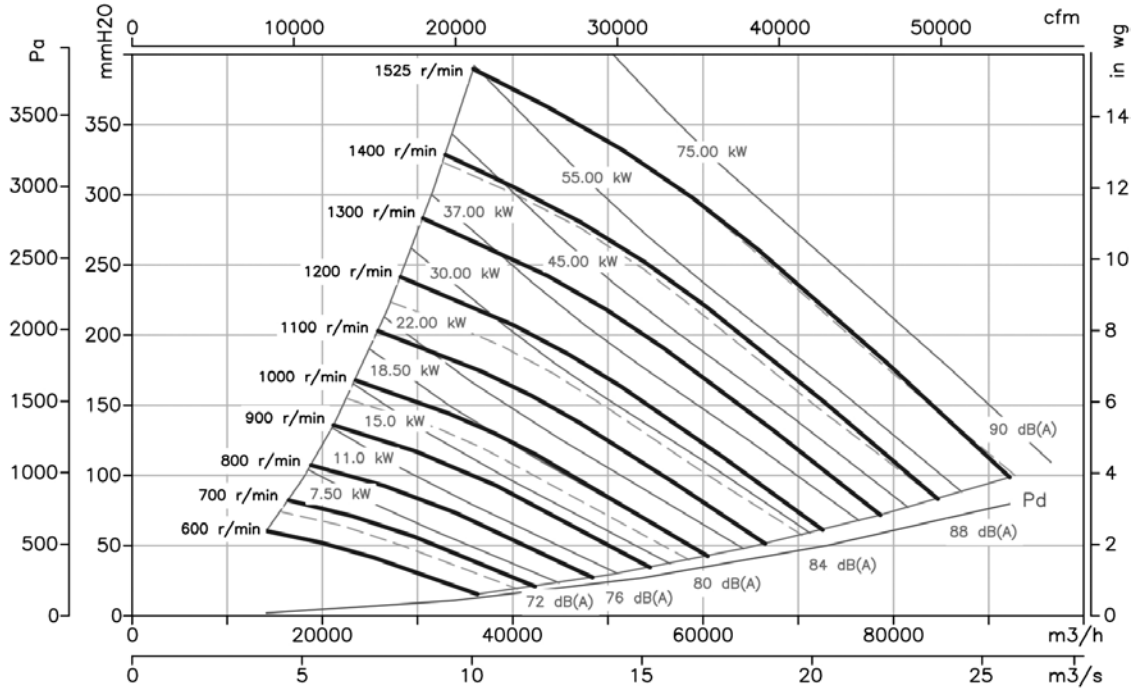

**CMRS-X 1120**

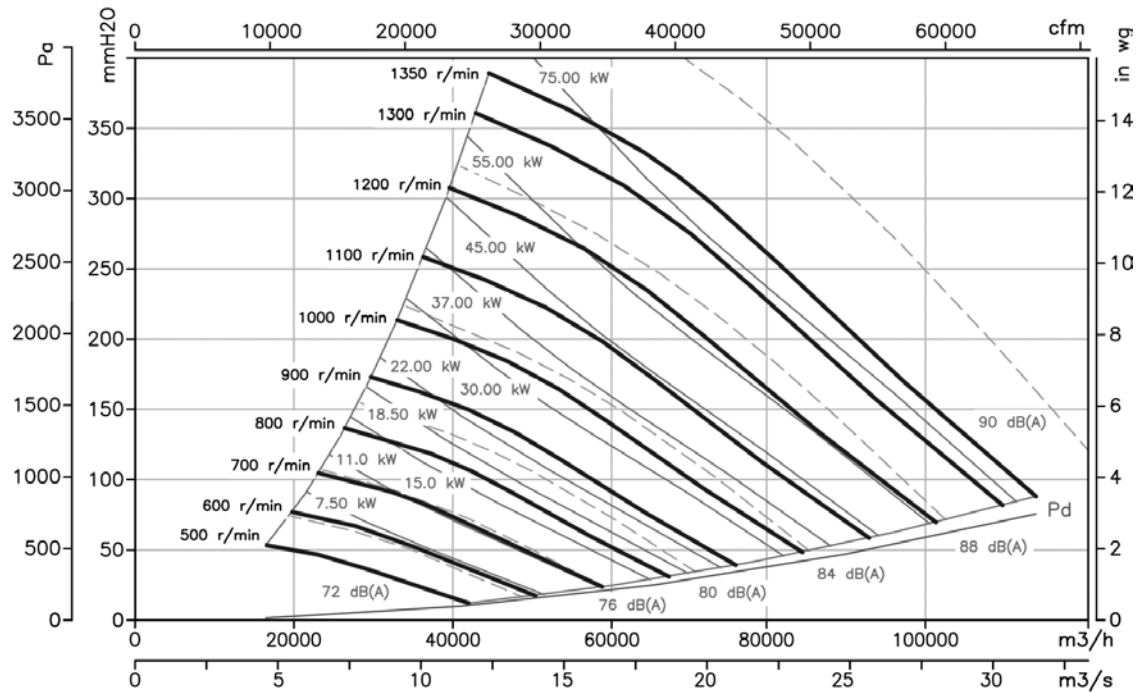

**Curvas Características**

Q= Caudal en m<sup>3</sup>/h, m<sup>3</sup>/s y cfm

Pe= Presión estática en mmH<sub>2</sub>O, Pa e inwg

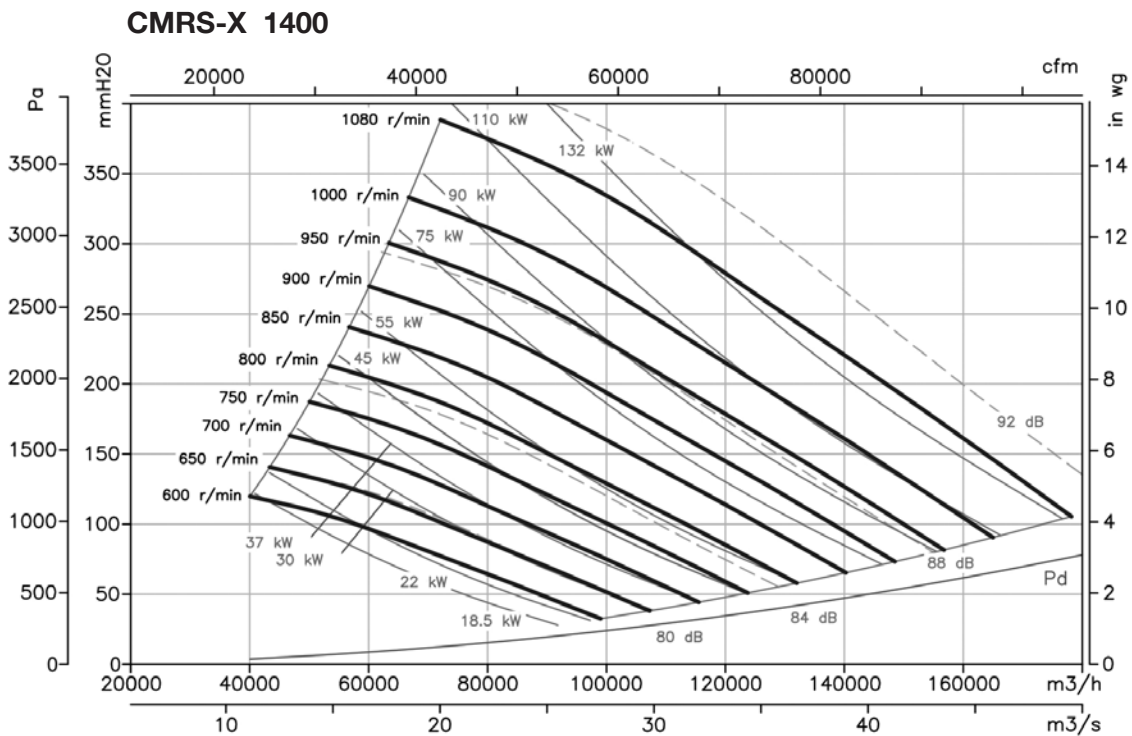
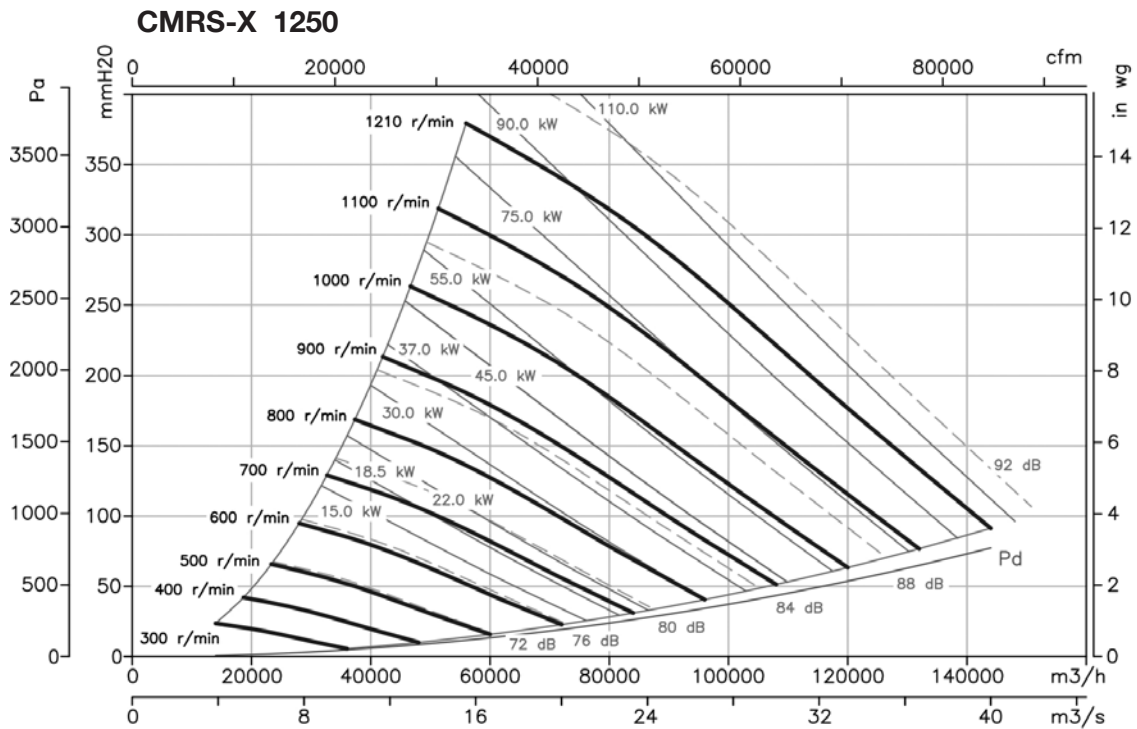

**Curvas Características**

Q= Caudal en m<sup>3</sup>/h, m<sup>3</sup>/s y cfm

Pe= Presión estática en mmH<sub>2</sub>O, Pa e in wg

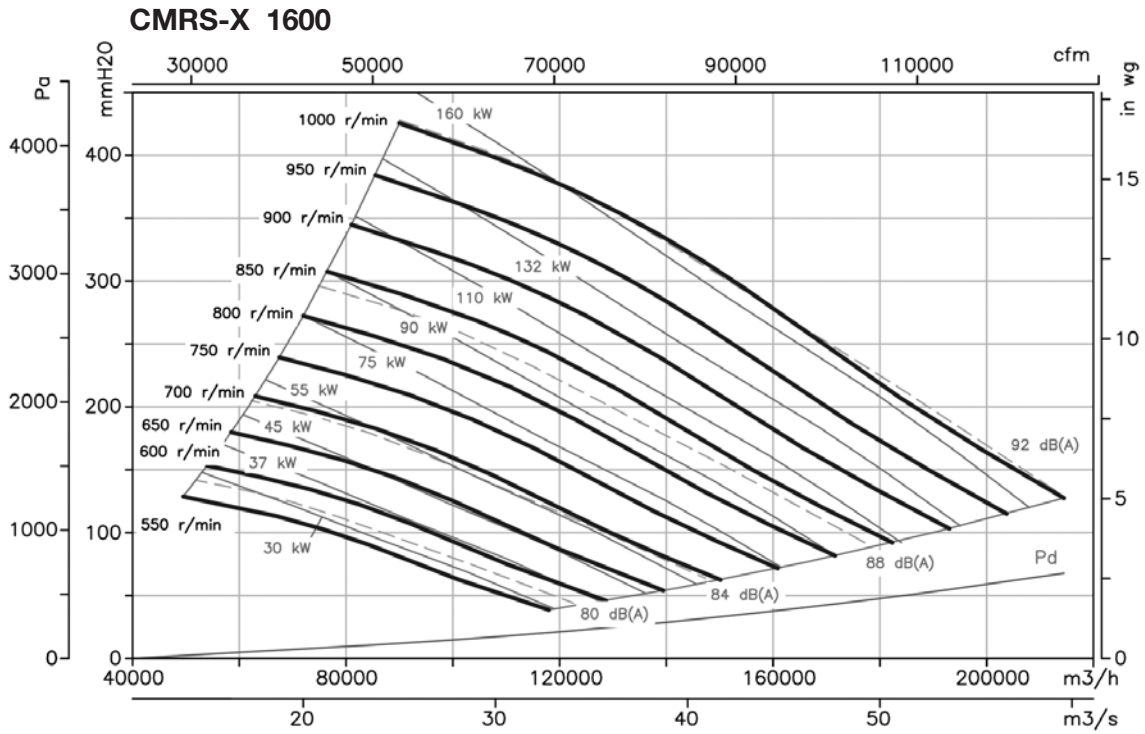

**Orientaciones**

Suministro standard LG 270

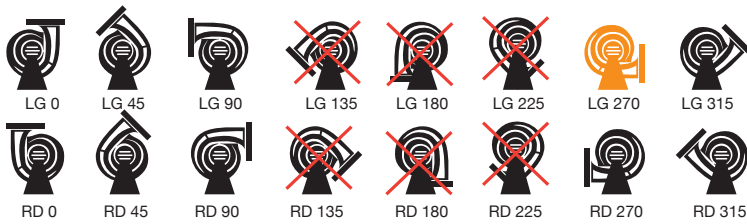

**Accesorios**

Ver apartado accesorios.



# CASB-X



**Ventiladores de alta presión accionados a transmisión, equipados con motor eléctrico, conjunto de poleas, correas y protectores normalizados según norma ISO-13857:2008**



**Ventilador:**

- Envoltorio en chapa de acero
- Turbina con álabes a reacción, en chapa de acero de gran robustez
- Motor montado sobre bancada general

**Motor:**

- Motores eficiencia IE3
- Motores clase F, con rodamientos a bolas, protección IP55
- Trifásicos 230/400V-50Hz (hasta 4kW) y 400/690V-50Hz (potencias superiores a 4kW)
- Temperatura máxima del aire a transportar: -20°C + 150°C

**Acabado:**

- Anticorrosivo en resina de poliéster polimerizada a 190 °C, previo desengrase con tratamiento nanotecnológico libre de fosfatos.

**Bajo demanda:**

- Bobinados especiales para diferentes tensiones
- Ventilador preparado para transportar aire hasta 250°C
- Ventilador en acero inoxidable
- Certificación ATEX Categoría 2
- Motores eficiencia IE2

**Código de pedido**

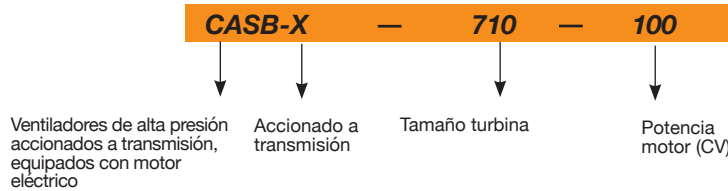

**Características técnicas**

Modelo	Velocidad (r/min)	Intensidad máx admisible (A)		Potencia instalada (kW)	Caudal máximo (m3/h)	Presión máxima (mm H <sub>2</sub> O)	Peso (Kg)
		400 V	690 V				
CASB-X-710-20 IE3	1690	28,1	16,2	15	19650	290	391
CASB-X-710-25 IE3	1810	35,2	20,3	18,5	21050	335	430
CASB-X-710-30 IE3	1910	41,2	23,8	22	22200	370	453
CASB-X-710-40 IE3	2120	57,3	33,1	30	24650	460	503
CASB-X-710-50 IE3	2280	69,1	39,9	37	26500	530	620
CASB-X-710-60 IE3	2430	81,2	46,9	45	28250	605	652
CASB-X-710-75 IE3	2600	99,1	57,2	55	30200	690	730
CASB-X-710-100 IE3	2890	131,5	75,9	75	33600	850	1005
CASB-X-800-20 IE3	1380	28,1	16,2	15	23750	245	486
CASB-X-800-25 IE3	1480	35,2	20,3	18,5	25450	280	525
CASB-X-800-30 IE3	1570	41,2	23,8	22	27000	315	548
CASB-X-800-40 IE3	1740	57,3	33,1	30	29900	390	598
CASB-X-800-50 IE3	1850	69,1	39,9	37	31800	440	715
CASB-X-800-60 IE3	1980	81,2	46,9	45	34050	505	747
CASB-X-800-75 IE3	2120	99,1	57,2	55	36450	580	825
CASB-X-800-100 IE3	2350	131,5	75,9	75	40400	710	1100
CASB-X-900-30 IE3	1310	41,2	23,8	22	31450	275	623
CASB-X-900-40 IE3	1460	57,3	33,1	30	35050	340	673
CASB-X-900-50 IE3	1570	69,1	39,9	37	37700	395	790
CASB-X-900-60 IE3	1670	81,2	46,9	45	40100	445	822
CASB-X-900-75 IE3	1780	99,1	57,2	55	42750	510	900
CASB-X-900-100 IE3	1970	131,5	75,9	75	47300	620	1175
CASB-X-900-125 IE3	2100	158,7	91,6	90	50400	705	1242
CASB-X-900-150 IE3	2240	194,0	112,0	110	53750	805	1305
CASB-X-1000-40 IE3	1210	57,3	33,1	30	39750	295	798
CASB-X-1000-50 IE3	1300	69,1	39,9	37	42700	340	915
CASB-X-1000-60 IE3	1390	81,2	46,9	45	45650	390	947
CASB-X-1000-75 IE3	1480	99,1	57,2	55	48600	440	1025
CASB-X-1000-100 IE3	1650	131,5	75,9	75	54200	550	1300
CASB-X-1000-125 IE3	1750	158,7	91,6	90	57500	620	1367

### Características técnicas

Modelo	Velocidad (r/min)	Intensidad máx admisible (A)		Potencia instalada (kW)	Caudal máximo (m <sup>3</sup> /h)	Presión máxima (mm H <sub>2</sub> O)	Peso (Kg)
		400 V	690 V				
CASB-X-1000-150 IE3	1870	194,0	112,0	110	61450	705	1430
CASB-X-1000-175 IE3	1980	232,1	134,0	132	65050	790	1502
CASB-X-1120-50 IE3	1100	69,1	39,9	37	48050	305	1120
CASB-X-1120-60 IE3	1190	81,2	46,9	45	52000	360	1152
CASB-X-1120-75 IE3	1270	99,1	57,2	55	55500	410	1230
CASB-X-1120-100 IE3	1400	131,5	75,9	75	61150	495	1505
CASB-X-1120-125 IE3	1500	158,7	91,6	90	65500	570	1572
CASB-X-1120-150 IE3	1600	194,0	112,0	110	69900	645	1635
CASB-X-1120-175 IE3	1700	232,1	134,0	132	74250	730	1707
CASB-X-1120-220 IE3	1800	280,6	162,0	160	78650	820	1780
CASB-X-1250-60 IE3	980	81,2	46,9	45	63350	310	1412
CASB-X-1250-75 IE3	1050	99,1	57,2	55	67900	355	1490
CASB-X-1250-100 IE3	1160	131,5	75,9	75	75000	435	1765
CASB-X-1250-125 IE3	1230	158,7	91,6	90	79550	485	1832
CASB-X-1250-150 IE3	1320	194,0	112,0	110	85350	560	1895
CASB-X-1250-175 IE3	1400	232,1	134,0	132	90550	630	1967
CASB-X-1250-220 IE3	1500	280,6	162,0	160	97000	725	2040
CASB-X-1250-270 IE3	1600	348,1	201,0	200	103450	825	2270
CASB-X-1400-75 IE3	870	99,1	57,2	55	77450	300	1810
CASB-X-1400-100 IE3	970	131,5	75,9	75	86350	370	2085
CASB-X-1400-125 IE3	1030	158,7	91,6	90	91700	420	2152
CASB-X-1400-150 IE3	1100	194,0	112,0	110	97900	480	2215
CASB-X-1400-175 IE3	1170	232,1	134,0	132	104150	540	2287
CASB-X-1400-220 IE3	1240	280,6	162,0	160	110350	610	2360
CASB-X-1400-270 IE3	1340	348,1	201,0	200	119250	710	2590
CASB-X-1400-340 IE3	1440	438,2	253,0	250	128150	820	2680
CASB-X-1600-100 IE3	760	131,5	75,9	75	100100	290	2435
CASB-X-1600-125 IE3	810	158,7	91,6	90	106700	330	2502
CASB-X-1600-150 IE3	870	194,0	112,0	110	114600	385	2565
CASB-X-1600-175 IE3	920	232,1	134,0	132	121200	430	2637
CASB-X-1600-220 IE3	980	280,6	162,0	160	129100	485	2710
CASB-X-1600-270 IE3	1060	348,1	201,0	200	139650	570	2940
CASB-X-1600-340 IE3	1140	438,2	253,0	250	150200	660	3030
CASB-X-1600-430 IE3	1230	557,7	322,0	315	162050	765	3260



### Erp. Características del punto de máxima eficiencia (BEP)

<b>MC</b>	Categoría de medición	<b>ηe[%]</b>	Eficiencia
<b>EC</b>	Categoría de eficiencia	<b>N</b>	Grado de eficiencia
<b>S</b>	Estática	<b>[kW]</b>	Potencia eléctrica
<b>T</b>	Total	<b>[m<sup>3</sup>/h]</b>	Caudal
<b>VSD</b>	Variador de velocidad	<b>[mmH<sub>2</sub>O]</b>	Presión estática o total (Según EC)
<b>SR</b>	Relación específica	<b>[RPM]</b>	Velocidad

Modelo	MC	EC	VSD	SR	ηe [%]	N	[kW]	[m <sup>3</sup> /h]	[mmH <sub>2</sub> O]	[RPM]
CASB-X-710-20 IE3	C	S	NO	1,02	66,1%	65,9	12,909	13131	238,65	1690
CASB-X-710-25 IE3	C	S	NO	1,03	66,5%	66,1	15,773	14063	273,75	1810
CASB-X-710-30 IE3	C	S	NO	1,03	66,8%	66,2	18,455	14840	304,83	1910
CASB-X-710-40 IE3	C	S	NO	1,04	67,2%	66,2	25,101	16471	375,55	2120
CASB-X-710-50 IE3	C	S	NO	1,04	67,7%	66,6	30,960	17715	434,38	2280
CASB-X-710-60 IE3	C	S	NO	1,05	67,7%	66,3	37,521	18880	493,41	2430
CASB-X-710-75 IE3	C	S	NO	1,06	67,9%	66,3	45,814	20201	564,86	2600
CASB-X-710-100 IE3	C	S	NO	1,07	68,2%	66,3	62,588	22454	697,90	2890
CASB-X-800-20 IE3	C	S	NO	1,02	65,1%	65,1	11,024	11773	223,84	1380
CASB-X-800-25 IE3	C	S	NO	1,03	65,5%	65,2	13,525	12626	257,46	1480
CASB-X-800-30 IE3	C	S	NO	1,03	65,8%	65,3	16,076	13394	289,72	1570





## Erp. Características del punto de máxima eficiencia (BEP)

<b>MC</b>	Categoría de medición	<b><math>\eta_e</math> [%]</b>	Eficiencia
<b>EC</b>	Categoría de eficiencia	<b>N</b>	Grado de eficiencia
<b>S</b>	Estática	<b>[kW]</b>	Potencia eléctrica
<b>T</b>	Total	<b>[m³/h]</b>	Caudal
<b>VSD</b>	Variador de velocidad	<b>[mmH₂O]</b>	Presión estática o total (Según EC)
<b>SR</b>	Relación específica	<b>[RPM]</b>	Velocidad

Modelo	MC	EC	VSD	SR	$\eta_e$ [%]	N	[kW]	[m³/h]	[mmH₂O]	[RPM]
CASB-X-800-40 IE3	C	S	NO	1,04	66,1%	65,3	21,767	14844	355,86	1740
CASB-X-800-50 IE3	C	S	NO	1,04	66,7%	65,7	25,940	15782	402,28	1850
CASB-X-800-60 IE3	C	S	NO	1,05	66,6%	65,4	31,835	16891	460,80	1980
CASB-X-800-75 IE3	C	S	NO	1,05	66,8%	65,4	38,953	18086	528,27	2120
CASB-X-800-100 IE3	C	S	NO	1,07	67,2%	65,4	52,778	20048	649,11	2350
CASB-X-900-30 IE3	C	S	NO	1,02	67,3%	66,7	17,961	18194	243,65	1310
CASB-X-900-40 IE3	C	S	NO	1,03	67,6%	66,7	24,732	20278	302,64	1460
CASB-X-900-50 IE3	C	S	NO	1,04	68,2%	67,0	30,493	21805	349,96	1570
CASB-X-900-60 IE3	C	S	NO	1,04	68,1%	66,8	36,738	23194	395,96	1670
CASB-X-900-75 IE3	C	S	NO	1,05	68,3%	66,8	44,345	24722	449,85	1780
CASB-X-900-100 IE3	C	S	NO	1,06	68,7%	66,8	59,799	27361	551,01	1970
CASB-X-900-125 IE3	C	S	NO	1,06	68,8%	66,7	72,284	29166	626,13	2100
CASB-X-900-150 IE3	C	S	NO	1,07	69,0%	66,7	87,543	31111	712,39	2240
CASB-X-1000-40 IE3	C	S	NO	1,03	69,0%	68,1	24,903	25981	242,66	1210
CASB-X-1000-50 IE3	C	S	NO	1,03	69,6%	68,4	30,621	27913	280,10	1300
CASB-X-1000-60 IE3	C	S	NO	1,03	69,5%	68,1	37,471	29846	320,22	1390
CASB-X-1000-75 IE3	C	S	NO	1,04	69,7%	68,1	45,088	31778	363,03	1480
CASB-X-1000-100 IE3	C	S	NO	1,05	70,1%	68,1	62,150	35428	451,22	1650
CASB-X-1000-125 IE3	C	S	NO	1,05	70,2%	68,1	73,993	37576	507,57	1750
CASB-X-1000-150 IE3	C	S	NO	1,06	70,4%	68,0	90,094	40152	579,57	1870
CASB-X-1000-175 IE3	C	S	NO	1,07	70,5%	68,0	106,723	42514	649,76	1980
CASB-X-1120-50 IE3	C	S	NO	1,03	68,8%	67,6	31,573	31864	250,09	1100
CASB-X-1120-60 IE3	C	S	NO	1,03	68,7%	67,2	40,017	34471	292,68	1190
CASB-X-1120-75 IE3	C	S	NO	1,03	68,9%	67,3	48,488	36788	333,36	1270
CASB-X-1120-100 IE3	C	S	NO	1,04	69,3%	67,3	64,613	40554	405,10	1400
CASB-X-1120-125 IE3	C	S	NO	1,05	69,4%	67,2	79,304	43451	465,03	1500
CASB-X-1120-150 IE3	C	S	NO	1,05	69,6%	67,2	96,045	46347	529,11	1600
CASB-X-1120-175 IE3	C	S	NO	1,06	69,7%	67,1	114,962	49244	597,31	1700
CASB-X-1120-220 IE3	C	S	NO	1,07	69,9%	67,1	136,181	52141	669,65	1800
CASB-X-1250-60 IE3	C	S	NO	1,03	70,2%	68,8	38,238	36762	267,86	980
CASB-X-1250-75 IE3	C	S	NO	1,03	70,4%	68,8	46,882	39388	307,49	1050
CASB-X-1250-100 IE3	C	S	NO	1,04	70,8%	68,8	62,882	43515	375,29	1160
CASB-X-1250-125 IE3	C	S	NO	1,04	70,9%	68,8	74,810	46140	421,95	1230
CASB-X-1250-150 IE3	C	S	NO	1,05	71,1%	68,7	92,269	49517	485,96	1320
CASB-X-1250-175 IE3	C	S	NO	1,06	71,2%	68,6	109,853	52518	546,65	1400
CASB-X-1250-220 IE3	C	S	NO	1,06	71,4%	68,6	134,833	56269	627,54	1500
CASB-X-1250-270 IE3	C	S	NO	1,07	71,4%	68,4	163,637	60020	714,00	1600
CASB-X-1400-75 IE3	C	S	NO	1,03	72,0%	70,3	47,212	51206	243,57	870
CASB-X-1400-100 IE3	C	S	NO	1,03	72,4%	70,4	65,092	57092	302,78	970
CASB-X-1400-125 IE3	C	S	NO	1,04	72,5%	70,3	77,770	60623	341,40	1030
CASB-X-1400-150 IE3	C	S	NO	1,04	72,7%	70,3	94,530	64743	389,38	1100
CASB-X-1400-175 IE3	C	S	NO	1,05	72,8%	70,2	113,512	68863	440,51	1170
CASB-X-1400-220 IE3	C	S	NO	1,05	73,0%	70,2	134,847	72983	494,80	1240
CASB-X-1400-270 IE3	C	S	NO	1,06	73,0%	69,9	170,174	78869	577,82	1340
CASB-X-1400-340 IE3	C	S	NO	1,07	73,1%	69,8	210,747	84754	667,29	1440
CASB-X-1600-100 IE3	C	S	NO	1,03	72,8%	70,9	55,377	56107	263,55	760
CASB-X-1600-125 IE3	C	S	NO	1,03	72,9%	70,9	66,901	59798	299,37	810
CASB-X-1600-150 IE3	C	S	NO	1,03	73,1%	70,8	82,723	64227	345,36	870
CASB-X-1600-175 IE3	C	S	NO	1,04	73,2%	70,8	97,617	67919	386,20	920
CASB-X-1600-220 IE3	C	S	NO	1,04	73,4%	70,7	117,743	72348	438,22	980
CASB-X-1600-270 IE3	C	S	NO	1,05	73,4%	70,5	148,996	78254	512,69	1060
CASB-X-1600-340 IE3	C	S	NO	1,06	73,5%	70,4	184,955	84160	592,99	1140
CASB-X-1600-430 IE3	C	S	NO	1,07	73,8%	70,4	231,587	90804	690,32	1230

Dimensiones mm

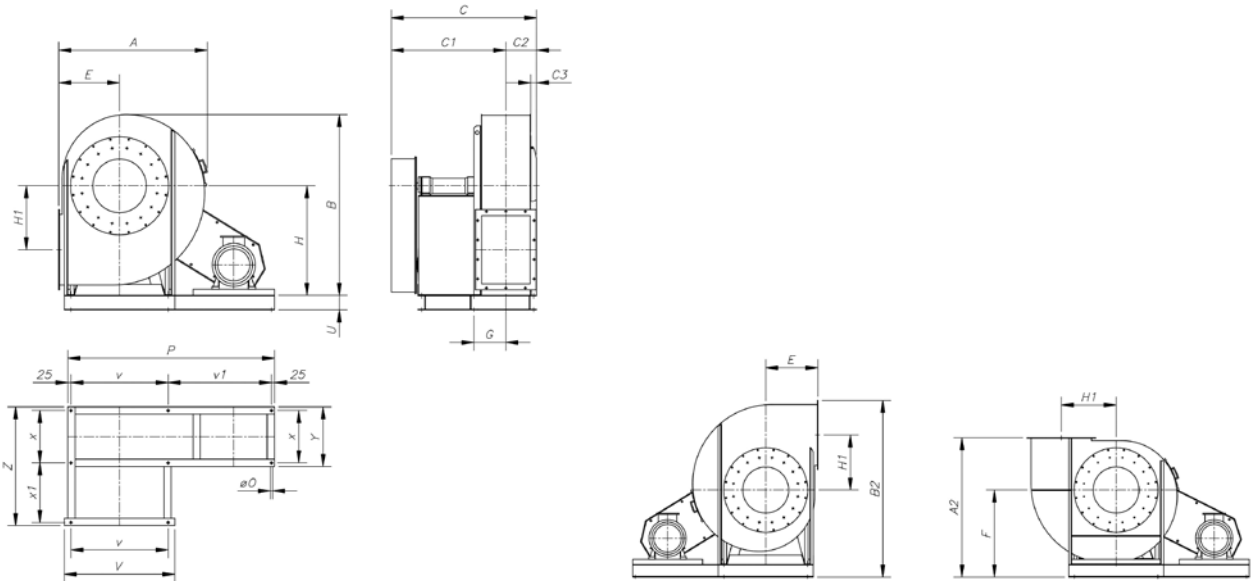

Modelo	A	A2	B	B2	C	C1	C2	C3	E	F	G	H	H1	P	øO	U	V	v	v1	x	x1	Y	Z
CASB-X-710	1240	1330	1505	1705	1160	907,5	252,5	47,5	500	830	263	900	525	1700	17	120	910	800	850	430	490	490	975
CASB-X-800	1375	1500	1670	1910	1290	1001,5	288,5	57,5	560	940	293	1000	585	2050	17	140	990	870	1120	495	550	555	1105
CASB-X-900	1530	1690	1795	2115	1340	1028	312	56	630	1060	318	1060	630	2150	19	160	1090	970	1120	495	601	555	1156
CASB-X-1000	1705	1890	1980	2350	1545	1192	353	66	710	1180	349	1180	710	2250	21	180	1210	1060	1120	600	668	670	1338
CASB-X-1120	1915	2100	2220	2610	1705	1306	399	77	800	1300	394	1320	800	2390	24	180	1350	1200	1120	670	753	750	1503
CASB-X-1250	2050	2260	2490	2910	1905	1466	439	74	830	1430	454	1500	900	2520	24	180	1480	1320	1120	750	853	830	1683
CASB-X-1400	2310	2450	2745	2930	2070	1575	495	-	950	1500	494	1650	1000	2700	24	180	1660	1500	1120	800	938	880	1818
CASB-X-1600	2580	2760	3070	3265	2355	1798	557	-	1060	1700	599	1850	1120	2920	24	200	1880	1700	1120	900	1103	1000	2103

Boca de aspiración

CASB-X-710  
CASB-X-800  
CASB-X-900  
CASB-X-1000  
CASB-X-1120

CASB-X-1250  
CASB-X-1400  
CASB-X-1600

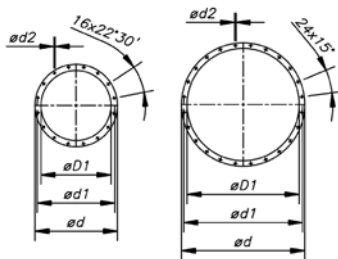

Boca de impulsión

CASB-X-1000  
CASB-X-800  
CASB-X-710

CASB-X-900

CASB-X-1250  
CASB-X-1120

CASB-X-1400

CASB-X-1600

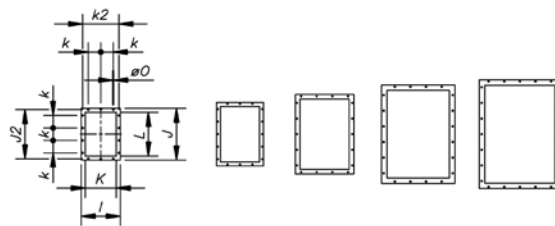

Modelo	øD1*	ød	ød1	ød2	L	J	J2	K	k	k2	L	øO
CASB-X-710	566	666	629	11,5	500	660	629	400	160	464	560	14
CASB-X-800	636	736	698	11,5	550	730	698	450	160	513	630	14
CASB-X-900	716	816	775	11,5	600	810	775	500	160	567	710	14
CASB-X-1000	806	906	861	14	680	920	871	560	200	639	800	14
CASB-X-1120	906	1006	958	14	750	1020	968	630	200	708	900	14
CASB-X-1250	1007	1107	1067	14	830	1120	1077	710	200	785	1000	14
CASB-X-1400	1128	1248	1200	14	940	1260	1210	800	200	881	1120	18
CASB-X-1600	1260	1380	1337	14	1040	1390	1347	900	200	978	1250	18

\* Diámetro nominal tubería recomendada

**Curvas Características**

Q= Caudal en m<sup>3</sup>/h, m<sup>3</sup>/s y cfm

Pe= Presión estática en mmH<sub>2</sub>O, Pa e inwg

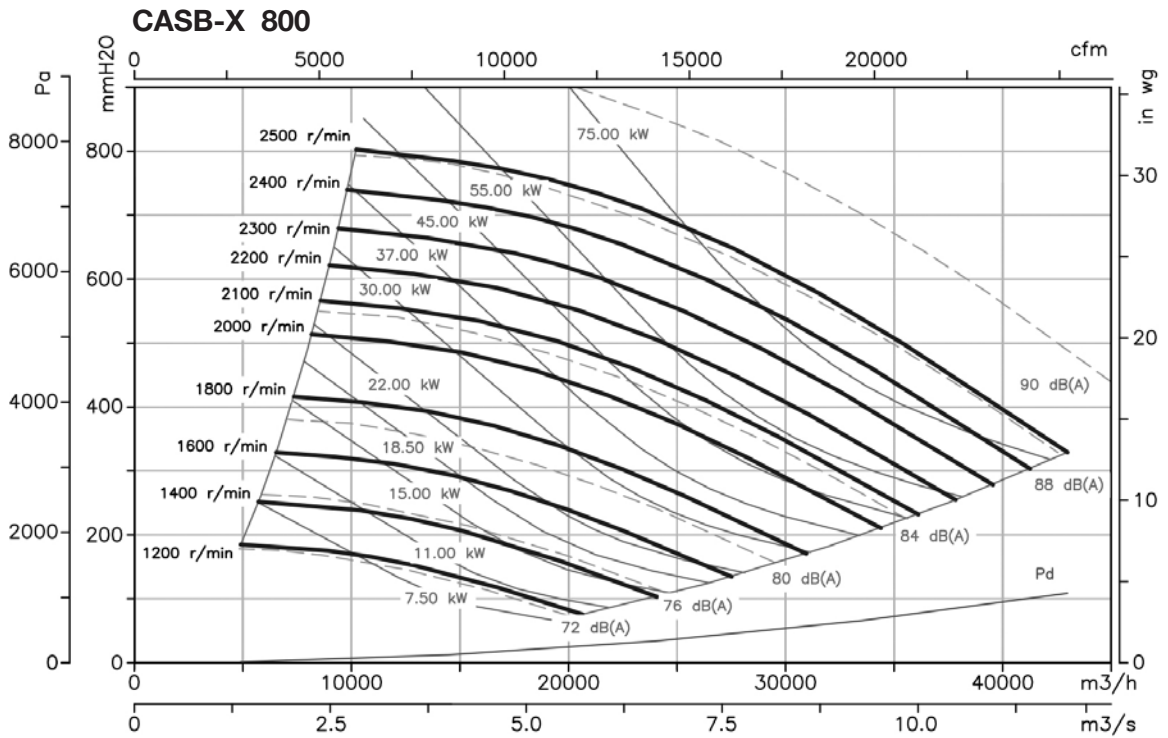
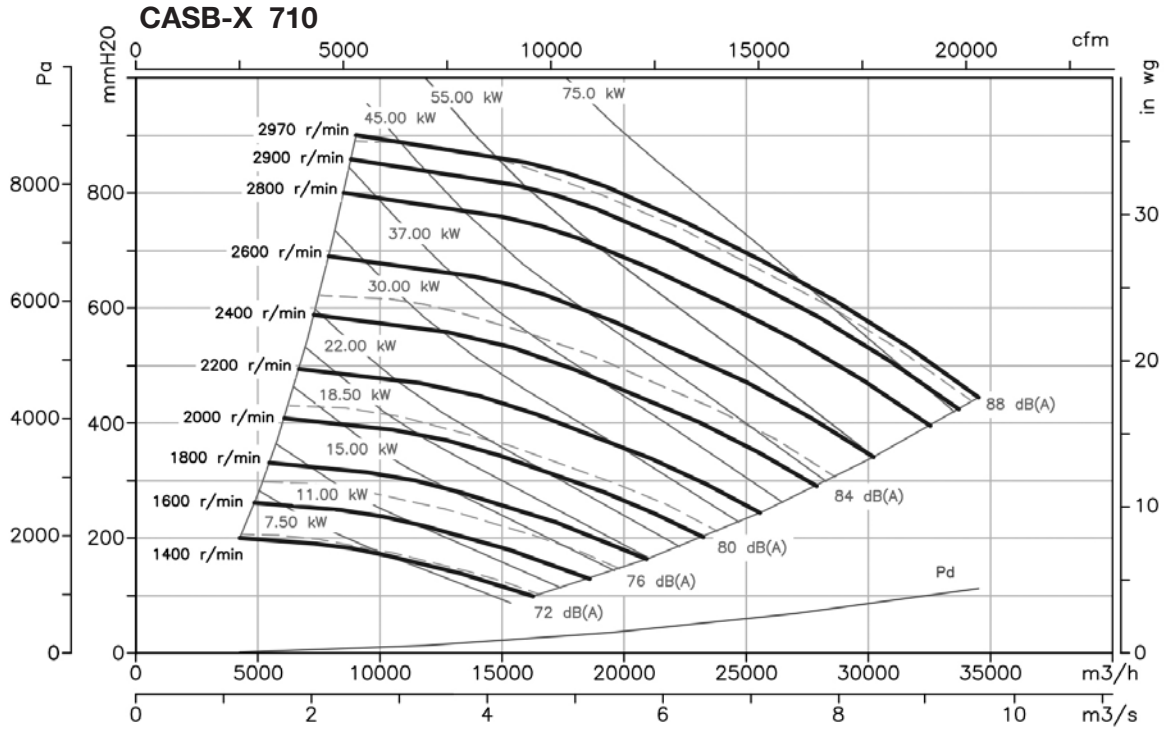

**Curvas Características**

Q= Caudal en m<sup>3</sup>/h, m<sup>3</sup>/s y cfm

Pe= Presión estática en mmH<sub>2</sub>O, Pa e inwg

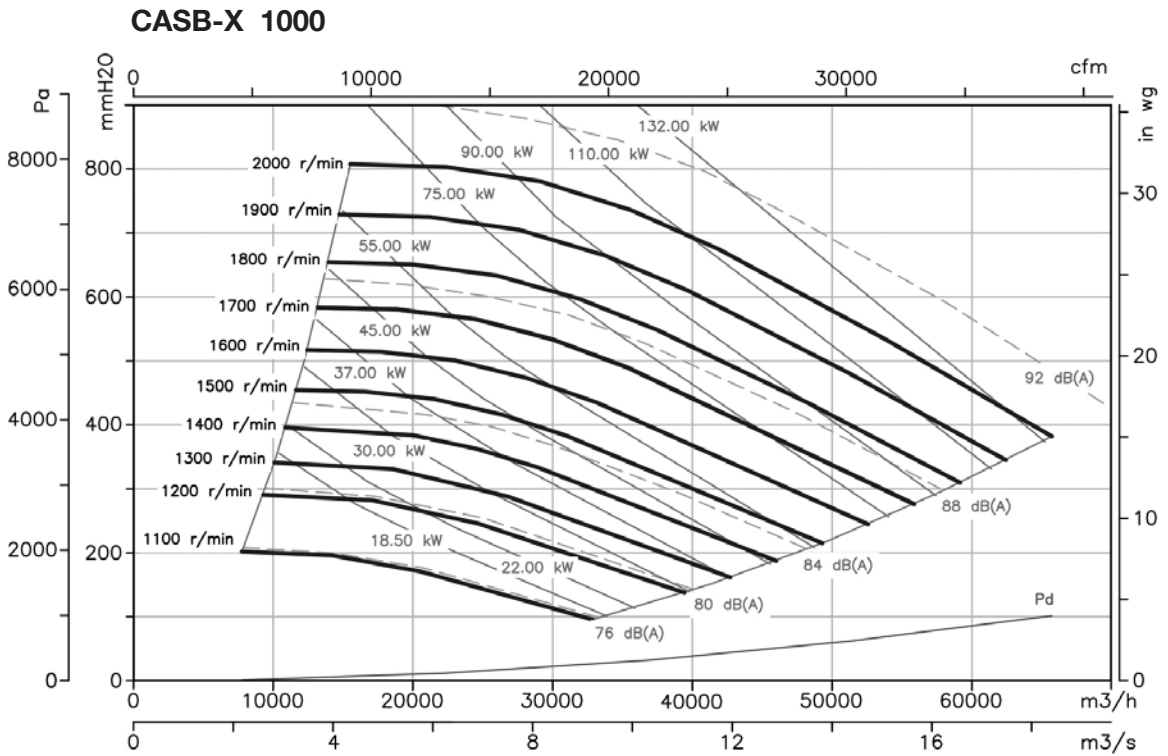
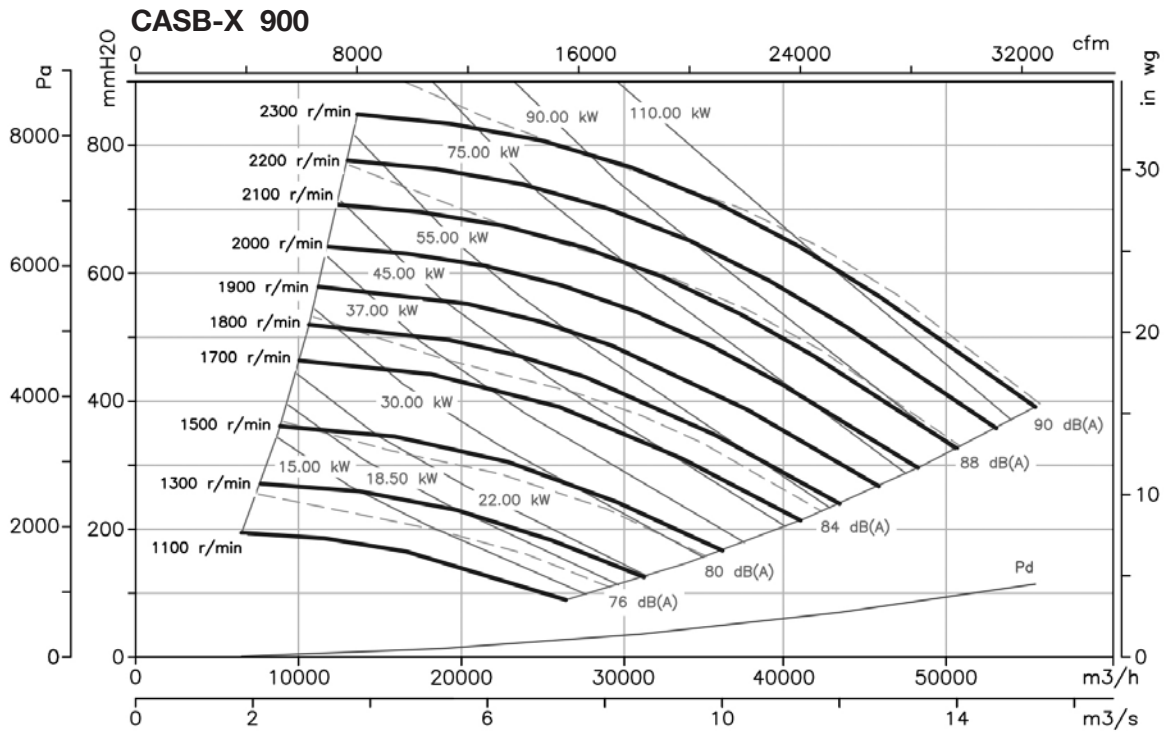

**Curvas Características**

Q= Caudal en m<sup>3</sup>/h, m<sup>3</sup>/s y cfm

Pe= Presión estática en mmH<sub>2</sub>O, Pa e inwg

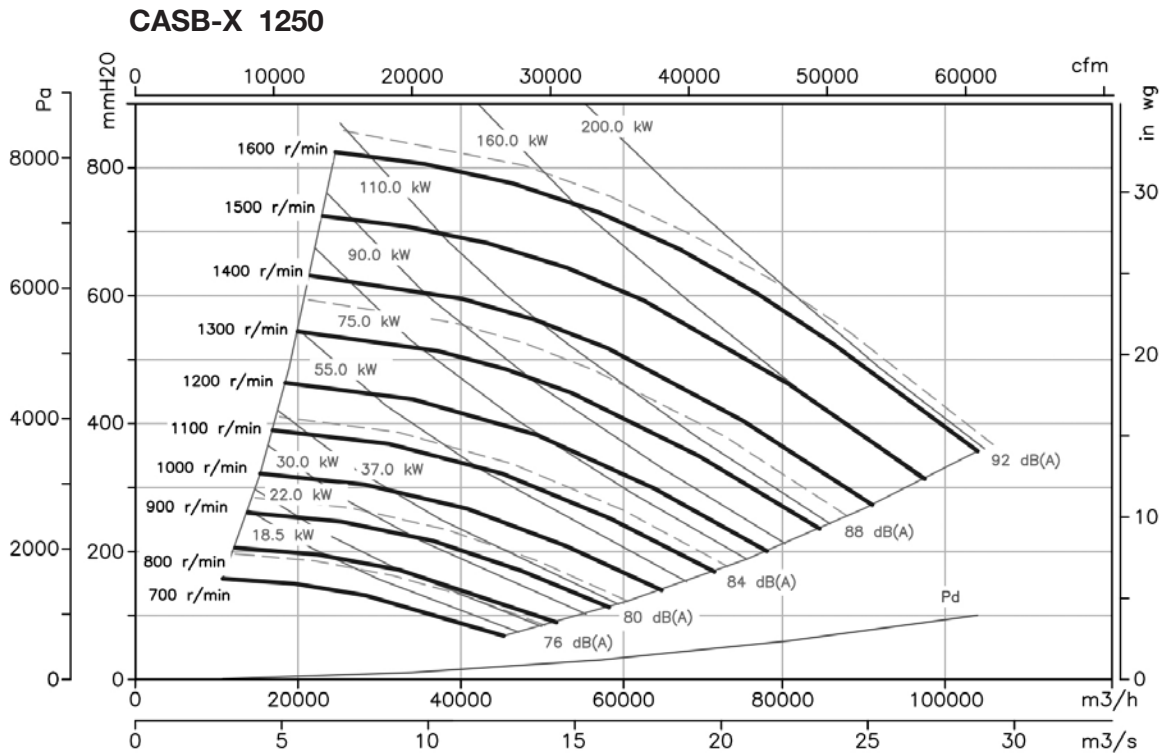
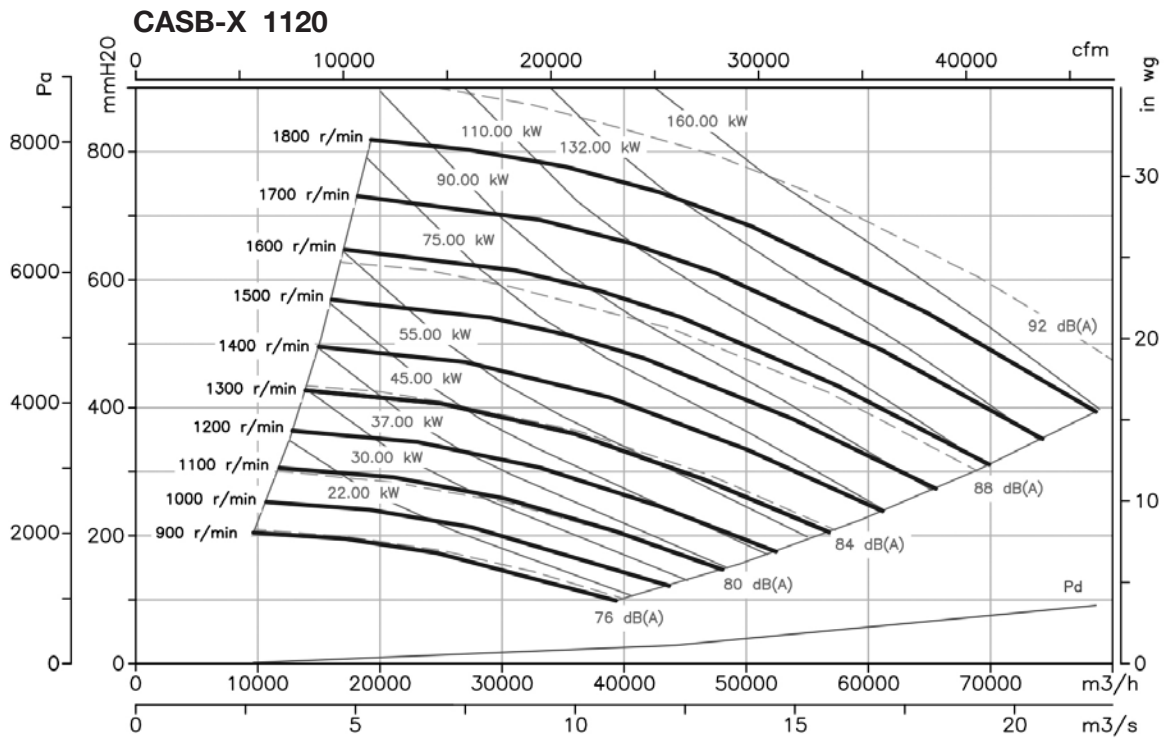

**Curvas Características**

Q= Caudal en m<sup>3</sup>/h, m<sup>3</sup>/s y cfm

Pe= Presión estática en mmH<sub>2</sub>O, Pa e inwg

**CASB-X 1400**

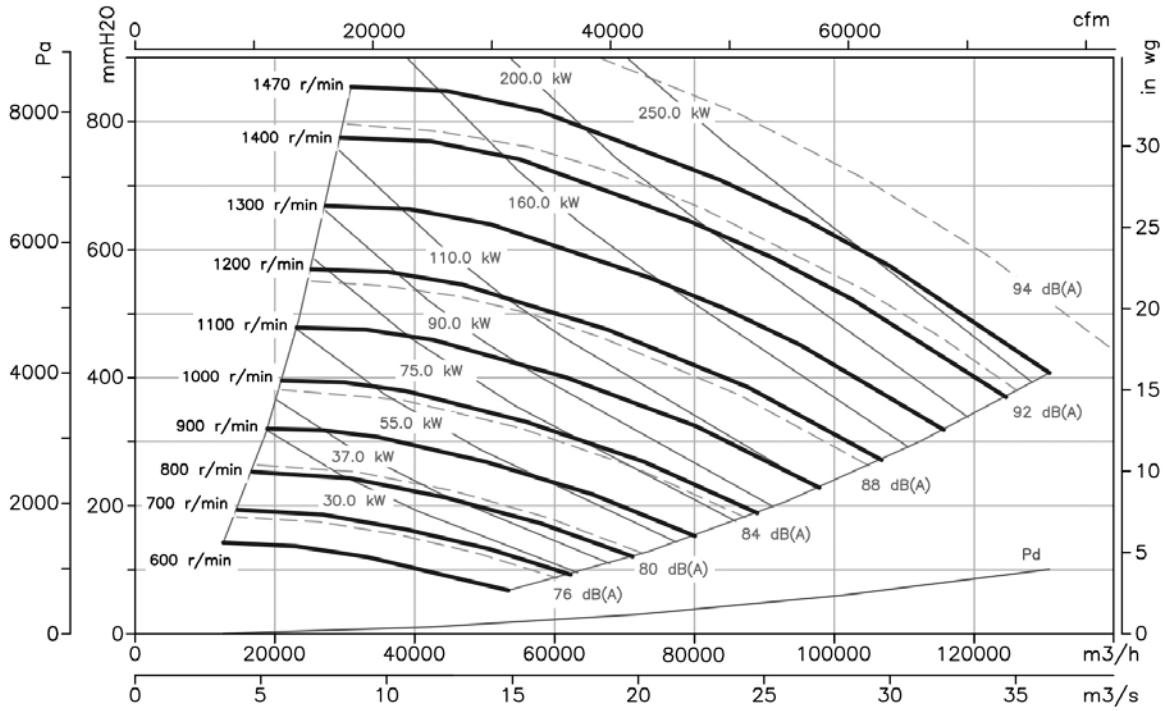

**CASB-X 1600**

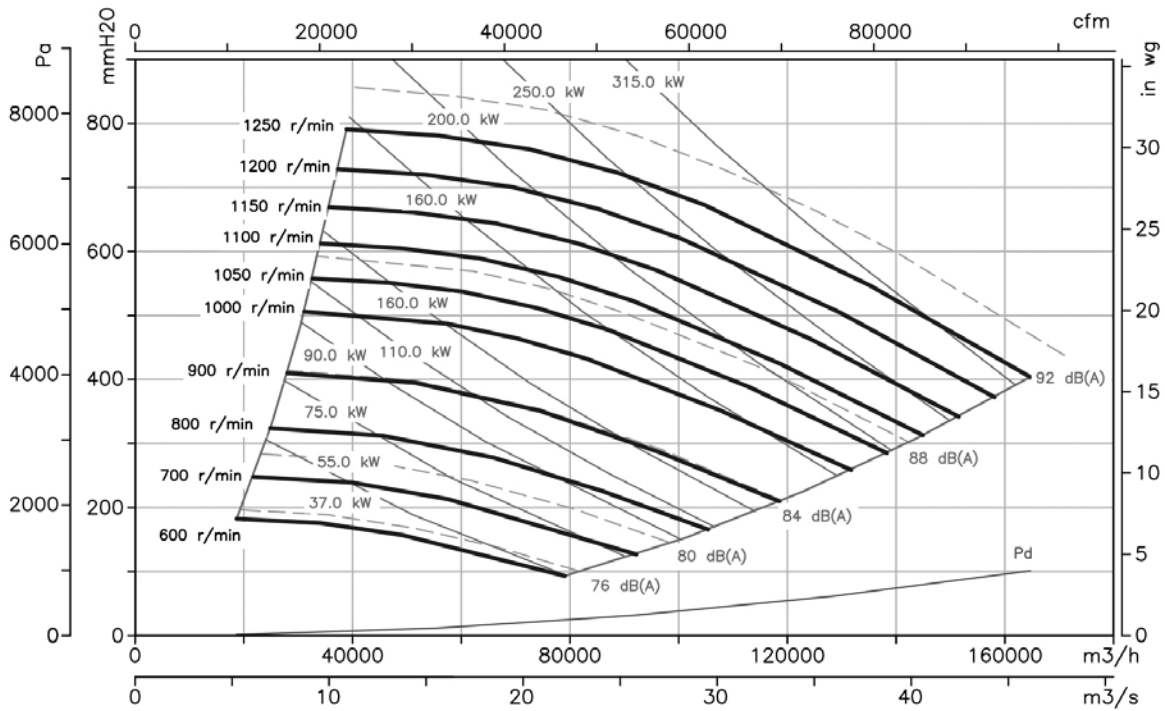

**Orientaciones**

Suministro standard LG 270

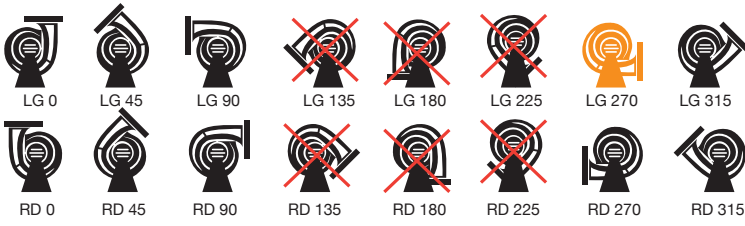

**Accesorios**

Ver apartado accesorios.



# CMP/MAR

**Extractores centrífugos de media presión equipados con turbina multipala para aplicaciones marinas**



Extractores centrífugos de media presión y simple aspiración con envolvente y turbina en chapa de acero, para trabajar en ambientes marinos y equipados con motor para servicio marino

**Ventilador:**

- Envolvente en chapa de acero
- Turbina con álabes hacia delante, en chapa de acero galvanizado
- Aro de aspiración en chapa de acero

**Motor:**

- Motores para servicio marino clase F, con rodamientos a bolas, protección IP55, con el cumplimiento de la clasificación para servicio naval no esencial.
- Motores de eficiencia IE3 para potencias iguales o superiores a 7,5kW, excepto monofásicos, 2 velocidades y 8 polos
- Trifásicos 230/400V.-50Hz.(hasta 4 kW) y 400/690V.-50Hz.(potencias superiores a 4 kW)
- Temperatura máxima del aire a transportar: -20°C.+ 120°C.

- tratamiento nanotecnológico libre de fosfatos.
- Calidad acabado superficial C3H

**Bajo demanda:**

- Acabados en acero galvanizado en caliente
- Construcción en acero inoxidable
- Bobinados especiales para diferentes tensiones y frecuencias
- Construcción ATEX para diferentes categorías
- Motores con PTC incorporada
- Motores marinos para aplicaciones navales, con certificación para servicio esencial según diferentes entidades de clasificación (BV, DNV, LR)
- Calidad acabado superficial C4H, C5M
- Motores de eficiencias IE2 e IE3 para cualquier potencia

**Acabado:**

- Anticorrosivo en resina de poliéster polimerizada a 190 °C, previo desengrase con

Los motores marinos utilizados pueden estar certificados por la mayoría de entidades internacionales de clasificación naval:

ABS: América Bureau of shipping

DNV: Det Norske Veritas

NK: Nippon Kaiji Kyokai

BV: Bureau Veritas

GL: Germanischer Lloyd

RINA: Registro Italiano Navale

CCS: China Classification Societies

KR: Korean Register of shipping

RS: Russian Maritime Register of Shipping

CR: China Corporation Register of Shipping

LR: Lloyd's Register of Shipping

### Código de pedido

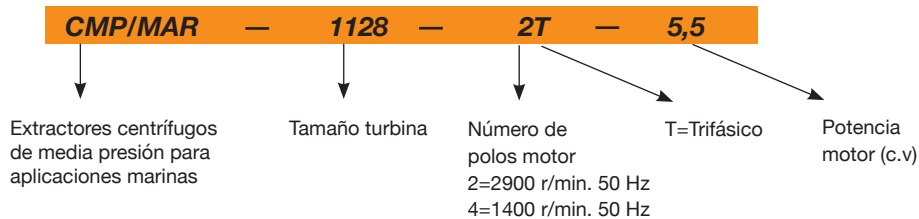

### Características técnicas

Modelo	Velocidad (r/min)	Intensidad máxima admisible (A)			Potencia instalada (kW)	Caudal máximo (m³/h)	Nivel sonora dB(A)	Peso aprox. con motor (Kg)
		230V	400V	690V				
CMP/MAR-616-2T	2760	2,57	1,49		0,55	1380	69	9
CMP/MAR-616-4T	1320	0,96	0,56		0,12	850	61	9
CMP/MAR-620-2T	2710	1,92	1,11		0,37	765	68	11
CMP/MAR-620-4T	1320	0,96	0,56		0,12	810	61	9
CMP/MAR-718-2T	2770	2,78	1,60		0,75	1485	70	14
CMP/MAR-718-4T	1350	1,66	0,96		0,25	1280	63	11
CMP/MAR-820-2T	2860	4,20	2,40		1,10	1950	73	18
CMP/MAR-820-4T	1350	1,66	0,96		0,25	1670	66	12
CMP/MAR-922-2T-1.5	2860	4,20	2,40		1,10	1650	70	23
CMP/MAR-922-2T-2	2770	5,44	3,13		1,50	2010	71	24
CMP/MAR-922-2T-3	2885	7,77	4,47		2,20	2600	74	27
CMP/MAR-922-4T	1380	2,92	1,69		0,55	2450	66	20
CMP/MAR-1025-2T-3	2885	7,77	4,47		2,20	2100	73	29
CMP/MAR-1025-2T-4	2900	10,18	5,88		3,00	2830	77	34
CMP/MAR-1025-4T	1400	4,03	2,32		1,10	3400	70	27



**Características técnicas**

Modelo	Velocidad (r/min)	Intensidad máxima admisible (A)			Potencia instalada (kW)	Caudal máximo (m³/h)	Nivel presión sonora dB(A)	Peso aprox. con motor (Kg)
		230V	400V	690V				
CMP/MAR-1128-2T-4	2900	10,18	5,88		3,00	2220	77	37
CMP/MAR-1128-2T-5.5	2870	13,60	7,82		4,00	3210	81	41
CMP/MAR-1128-4T	1445	8,36	4,83		2,20	5000	74	37
CMP/MAR-1231-4T-3	1445	8,36	4,83		2,20	4740	73	46
CMP/MAR-1231-4T-4	1445	10,96	6,33		3,00	5910	75	49
CMP/MAR-1231-4T-5.5	1440	14,10	8,12		4,00	6850	77	53
CMP/MAR-1435-4T-4	1445	10,96	6,33		3,00	5560	76	54
CMP/MAR-1435-4T-5.5	1440	14,10	8,12		4,00	6260	78	61
CMP/MAR-1435-4T-7.5	1460		10,60	6,10	5,50	7210	80	74
CMP/MAR-1640-4T-5.5	1440	14,10	8,12		4,00	7000	77	79
CMP/MAR-1640-4T-7.5	1460		10,60	6,10	5,50	8035	80	92
CMP/MAR-1640-4T-10 IE3	1465		13,90	8,06	7,50	9710	82	116
CMP/MAR-1845-4T-7.5	1460		10,60	6,10	5,50	8000	82	94
CMP/MAR-1845-4T-10 IE3	1465		13,90	8,06	7,50	10000	85	118
CMP/MAR-2050-4T-10 IE3	1465		13,90	8,06	7,50	9000	83	151
CMP/MAR-2050-4T-15 IE3	1470		20,90	12,10	11,00	12525	87	187
CMP/MAR-2050-4T-20 IE3	1465		27,90	16,20	15,00	16500	89	198

**Características acústicas**

Los valores indicados, se determinan mediante medidas de nivel de presión y potencia sonora en dB(A) obtenidas en campo libre a una distancia equivalente a dos veces la envergadura del ventilador más el diámetro de la turbina, con un mínimo de 1,5 mts.

Espectro de potencia sonora Lw(A) en dB(A) banda de frecuencia en [Hz]

Modelo	Lp dB (A)	63	125	250	500	1000	2000	4000	8000	Modelo	Lp dB (A)	63	125	250	500	1000	2000	4000	8000
CMP/MAR-616-2T	69	44	54	65	72	76	73	71	64	CMP/MAR-1128-2T-5.5	81	56	66	77	84	88	85	83	76
CMP/MAR-616-4T	61	36	46	57	64	68	65	63	56	CMP/MAR-1128-4T	74	49	59	70	77	81	78	76	69
CMP/MAR-620-2T	68	43	53	64	71	75	72	70	63	CMP/MAR-1231-4T-3	73	51	60	71	78	82	80	78	71
CMP/MAR-620-4T	61	36	46	57	64	68	65	63	56	CMP/MAR-1231-4T-4	75	53	62	73	80	84	82	80	73
CMP/MAR-718-2T	70	45	55	66	73	77	74	72	65	CMP/MAR-1231-4T-5.5	77	55	64	75	82	86	84	82	75
CMP/MAR-718-4T	63	38	48	59	66	70	67	65	58	CMP/MAR-1435-4T-4	76	54	63	74	81	85	83	81	74
CMP/MAR-820-2T	73	48	58	69	76	80	77	75	68	CMP/MAR-1435-4T-5.5	78	56	65	76	83	87	85	83	76
CMP/MAR-820-4T	66	41	51	62	69	73	70	68	61	CMP/MAR-1435-4T-7.5	80	58	67	78	85	89	87	85	78
CMP/MAR-922-2T-1.5	70	45	55	66	73	77	74	72	65	CMP/MAR-1640-4T-5.5	77	55	64	75	82	86	84	82	75
CMP/MAR-922-2T-2	71	46	56	67	74	78	75	73	66	CMP/MAR-1640-4T-7.5	80	58	67	78	85	89	87	85	78
CMP/MAR-922-2T-3	74	49	59	70	77	81	78	76	69	CMP/MAR-1640-4T-10	82	60	69	80	87	91	89	87	80
CMP/MAR-922-4T	66	41	51	62	69	73	70	68	61	CMP/MAR-1845-4T-7.5	82	61	71	82	89	93	91	89	81
CMP/MAR-1025-2T-3	73	48	58	69	76	80	77	75	68	CMP/MAR-1845-4T-10	85	64	74	85	92	96	94	92	84
CMP/MAR-1025-2T-4	77	52	62	73	80	84	81	79	72	CMP/MAR-2050-4T-10	83	62	72	83	90	94	92	90	82
CMP/MAR-1025-4T	70	45	55	66	73	77	74	72	65	CMP/MAR-2050-4T-15	87	66	76	87	94	98	96	94	86
CMP/MAR-1128-2T-4	77	52	62	73	80	84	81	79	72	CMP/MAR-2050-4T-20	89	68	78	89	96	100	98	96	88

**Dimensiones mm**

**CMP/MAR-616...820**

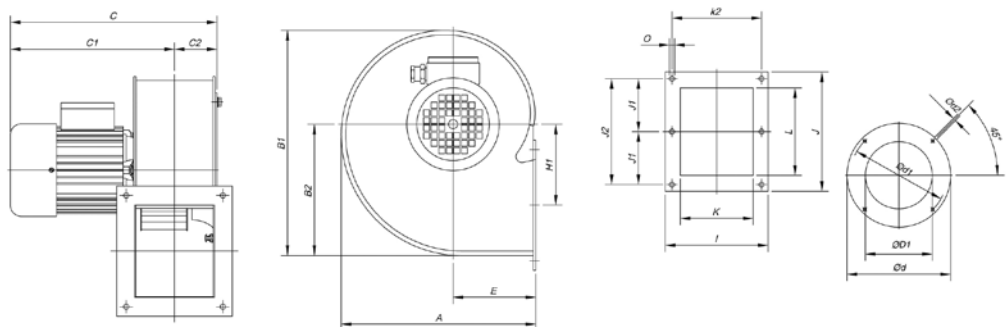

Modelo	A	B1	B2	C	C1	C2	øD1*	ød	ød1	ød2	E	H1	I	J	J1	J2	K	k2	L	øO
CMP/MAR-616-2T	258	297	173,5	320	264	56	160	204	180	M6	110	105,5	153	172	-	147	103	128	122	7
CMP/MAR-616-4T	258	297	173,5	283	227	56	160	204	180	M6	110	105,5	153	172	-	147	103	128	122	7
CMP/MAR-620-2T	298	347	202,5	321	265	56	200	247	230	M6	126	145,5	159	153	-	128	105	134	100	8
CMP/MAR-620-4T	298	347	202,5	283	227	56	200	247	230	M6	126	145,5	159	153	-	128	105	134	100	8
CMP/MAR-718-2T	303,5	348	201	355	294	61	180	238	210	M6	129,5	122	169	192	85	170	115	145	146	9
CMP/MAR-718-4T	303,5	348	201	331	270	61	180	238	210	M6	129,5	122	169	192	85	170	115	145	146	9
CMP/MAR-820-2T	322	377	223	369,5	301	68,5	200	247	230	M6	137,5	137	184	213	94,5	189	130	160	156	9
CMP/MAR-820-4T	322	377	223	345,5	277	68,5	200	247	230	M6	137,5	137	184	213	94,5	189	130	160	156	9

Dimensiones mm

CMP/MAR-922...1231

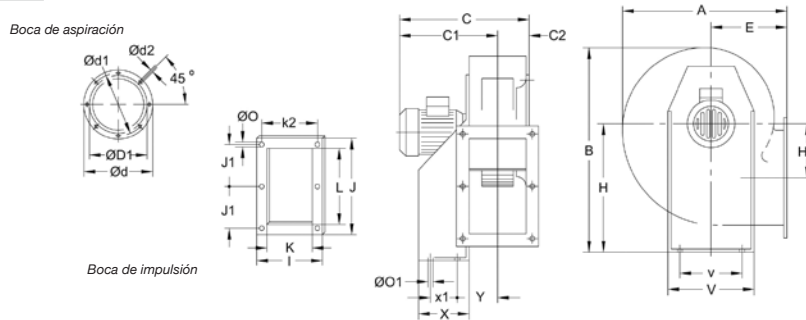

Modelo	A	B	C	C1	C2	øD1*	ød	ød1	ød2	E	H	H1	I	J	J1	K	k2	L	øO	øO1	V	v	X	x1	Y
CMP/MAR-922-2T-1'5	388,5	455	382,5	309	73,5	224	278	256	M8	180	280	134	204	282,5	128	140	180	215	9,5	10,5	290	220	114	50	105
CMP/MAR-922-2T-2	388,5	455	430,5	357	73,5	224	278	256	M8	180	280	134	204	282,5	128	140	180	215	9,5	10,5	290	220	114	50	105
CMP/MAR-922-2T-3	388,5	455	430,5	357	73,5	224	278	256	M8	180	280	134	204	282,5	128	140	180	215	9,5	10,5	290	220	114	50	105
CMP/MAR-922-4T	388,5	455	382,5	309	73,5	224	278	256	M8	180	280	134	204	282,5	128	140	180	215	9,5	10,5	290	220	114	50	105
CMP/MAR-1025-2T-3	427	503	456	370	86	250	305	282	M8	197	310	144	229	312,5	145	165	205	250	9,5	12,5	315	228	134	74	115,5
CMP/MAR-1025-2T-4	427	503	486	400	86	250	305	282	M8	197	310	144	229	312,5	145	165	205	250	9,5	12,5	315	228	134	74	115,5
CMP/MAR-1025-4T	427	503	456	370	86	250	305	282	M8	197	310	144	229	312,5	145	165	205	250	9,5	12,5	315	228	134	74	115,5
CMP/MAR-1128-2T-4	472	553	500,5	407	93,5	280	348	320	M8	216	340	152	244	364	170	180	220	296,5	9,5	12,5	348	245	144	95	122,5
CMP/MAR-1128-2T-5'5	472	553	523,5	430	93,5	280	348	320	M8	216	340	152	244	364	170	180	220	296,5	9,5	12,5	348	245	144	95	122,5
CMP/MAR-1128-4T	472	553	500,5	407	93,5	280	348	320	M8	216	340	152	244	364	170	180	220	296,5	9,5	12,5	348	245	144	95	122,5
CMP/MAR-1231-4T-3	526	630	520,5	417	103,5	315	382	354	M8	238	390	179,5	264	382,5	180	200	240	320	11,5	13	382	322	183	140	126
CMP/MAR-1231-4T-4	526	630	520,5	417	103,5	315	382	354	M8	238	390	179,5	264	382,5	180	200	240	320	11,5	13	382	322	183	140	126
CMP/MAR-1231-4T-5'5	526	630	543,5	440	103,5	315	382	354	M8	238	390	179,5	264	382,5	180	200	240	320	11,5	13	382	322	183	140	126

\*Diámetro nominal tubería recomendada

CMP/MAR-1435...2050

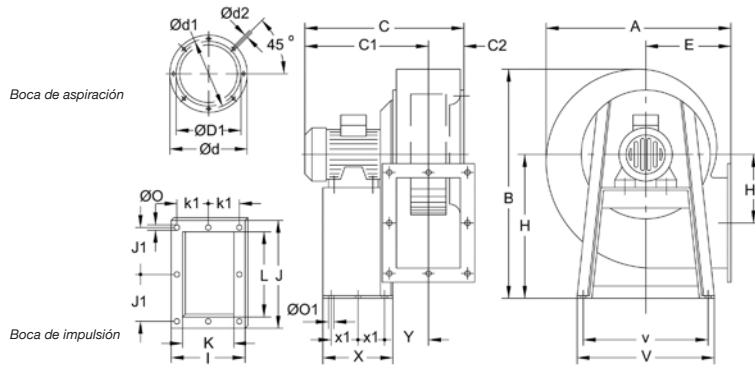

Modelo	A	B	C	C1	C2	øD1*	ød	ød1	ød2	E	H	H1	I	J	J1	K	k1	L	øO	øO1	V	v	X	X1	Y
CMP/MAR-1435-4T-4	573,5	715	549	431	118	355	422	394	M8	250	445	242,5	292	342,5	159	228	133	280	11,5	12	456	420	333	136,5	150
CMP/MAR-1435-4T-5'5	573,5	715	572	454	118	355	422	394	M8	250	445	242,5	292	342,5	159	228	133	280	11,5	12	456	420	333	136,5	150
CMP/MAR-1435-4T-7'5	573,5	715	610	492	118	355	422	394	M8	250	445	242,5	292	342,5	159	228	133	280	11,5	12	456	420	333	136,5	150
CMP/MAR-1640-4T-5'5	634	799	596	465	130	400	464	438	M8	270	495	271	336	404	185	250	150	321	11,5	12	500	460	327	133,5	162,5
CMP/MAR-1640-4T-7'5	634	799	634	504	130	400	464	438	M8	270	495	271	336	404	185	250	150	321	11,5	12	500	460	327	133,5	162,5
CMP/MAR-1640-4T-10	634	799	634	504	130	400	464	438	M8	270	495	271	336	404	185	250	150	321	11,5	12	500	460	327	133,5	162,5
CMP/MAR-1845-4T-7'5	711	901	668	521	147	450	515	485	M8	302	560	305	370	444	202	284	164	361	11,5	12	538	502	340	140	179,5
CMP/MAR-1845-4T-10	711	901	668	521	147	450	515	485	M8	302	560	305	370	444	202	284	164	361	11,5	12	538	502	340	140	179,5
CMP/MAR-2050-4T-10	797	987	700,5	538	162,5	500	565	535	M10	345	610	313	411	544	250	315	182,5	451	11,5	12	653	615	435	188	196
CMP/MAR-2050-4T-15	797	987	805,5	643	162,5	500	565	535	M10	345	610	313	411	544	250	315	182,5	451	11,5	12	653	615	435	188	196
CMP/MAR-2050-4T-20	797	987	805,5	643	162,5	500	565	535	M10	345	610	313	411	544	250	315	182,5	451	11,5	12	653	615	435	188	196

\*Diámetro nominal tubería recomendada

**Curvas características**

Ver página 162

**Orientaciones**

Suministro standard LG 270

Posiciones LG 180 y RD 180 bajo demanda y con medidas de anclaje especiales.

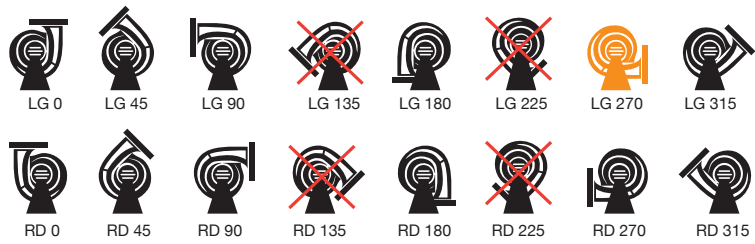

**Accesorios**

Ver apartado accesorios.



# CMPI

## Extractores centrífugos de media presión equipados con turbina multipala construidos en acero inoxidable AISI-304



Extractores centrífugos de media presión y simple aspiración con envolvente y turbina en chapa de acero inoxidable, para trabajar en ambientes químicos, agresivos o marinos



**Ventilador:**

- Carcasa y turbina con álabes hacia delante en acero inoxidable AISI-304

**Motor:**

- Motores clase F, con rodamientos a bolas, protección IP55, excepto modelos monofásicos protección IP-54
- Motores de eficiencia IE3 para potencias iguales o superiores a 7,5kW, excepto monofásicos, 2 velocidades y 8 polos
- Monofásicos 230V.-50Hz y trifásicos 230/400V.-50Hz.(hasta 4 kW) y 400/690V.-50Hz.(potencias superiores a 4 kW)
- Temperatura máxima del aire a transportar: -20°C.+ 120°C.

**Acabado:**

- Anticorrosivo en acero inoxidable.

**Bajo demanda:**

- Bobinados especiales para diferentes tensiones y frecuencias
- Construcción ATEX para diferentes categorías
- Construcción con motor para servicio marino
- Motores marinos para aplicaciones navales, con certificación para servicio esencial según diferentes entidades de clasificación (BV, DNV, LR)
- Motores CE, NEMA, UL, CSA
- Motores de eficiencias IE2 e IE3 para cualquier potencia
- Construcción en chapa de acero inoxidable AISI-316

### Código de pedido

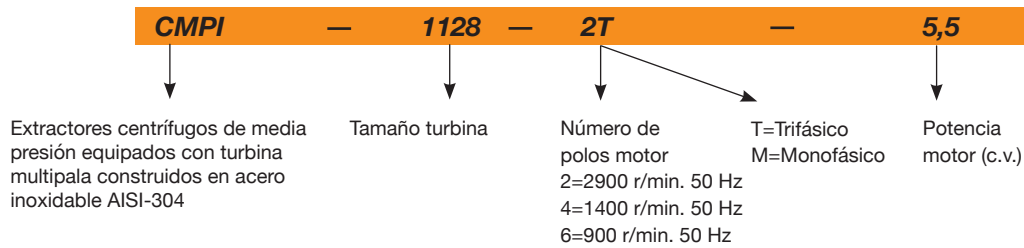

### Características técnicas

Modelo	Velocidad (r/min)	Intensidad máxima admisible (A)			Potencia instalada (kW)	Caudal máximo (m³/h)	Nivel presión sonora dB(A)	Peso aprox. (Kg)
		230V	400V	690V				
CMPI-512-2T	2670	0,64	0,37		0,09	380	62	4,0
CMPI-512-2M	2760	0,79			0,09	380	62	4,0
CMPI-512-4T	1320	0,55	0,32		0,06	255	55	3,5
CMPI-512-4M	1360	0,59			0,06	255	55	3,5
CMPI-514-2T	2750	1,21	0,70		0,18	700	65	5,0
CMPI-514-2M	2780	1,42			0,18	700	65	5,0
CMPI-514-4T	1320	0,65	0,38		0,09	565	58	4,5
CMPI-514-4M	1370	0,83			0,09	565	58	4,5
CMPI-616-2T	2760	2,57	1,49		0,55	1380	69	8,0
CMPI-616-2M	2810	3,49			0,55	1380	69	9,5
CMPI-616-4T	1320	0,96	0,56		0,12	850	61	7,5
CMPI-616-4M	1380	1,03			0,12	850	61	7,5
CMPI-620-2T	2710	1,92	1,11		0,37	765	68	9,5
CMPI-620-2M	2780	2,53			0,37	765	68	10,0
CMPI-620-4T	1320	0,96	0,56		0,12	810	61	7,5
CMPI-620-4M	1380	1,03			0,12	810	61	7,5
CMPI-718-2T	2770	2,78	1,60		0,75	1485	70	12,5
CMPI-718-2M	2810	4,50			0,75	1485	70	12,8
CMPI-718-4T	1350	1,66	0,96		0,25	1280	63	9,5
CMPI-718-4M	1370	2,00			0,25	1280	63	9,5
CMPI-820-2T	2860	4,20	2,40		1,10	1950	73	15,0
CMPI-820-2M	2820	6,51			1,10	1950	73	16,0
CMPI-820-4T	1350	1,66	0,96		0,25	1670	66	10,0

**Características técnicas**

Modelo	Velocidad (r/min)	Intensidad máxima admisible (A)			Potencia instalada (kW)	Caudal máximo (m³/h)	Nivel presión sonora dB(A)	Peso aprox. (Kg)
		230V	400V	690V				
CMPI-820-4M	1370	2,00			0,25	1670	66	10,0
CMPI-922-2T-1.5	2860	4,20	2,40		1,10	1650	70	20,0
CMPI-922-2T-2	2770	5,44	3,13		1,50	2010	71	23,0
CMPI-922-2T-3	2885	7,77	4,47		2,20	2600	74	25,5
CMPI-922-4T	1380	2,92	1,69		0,55	2450	66	19,0
CMPI-1025-2T-3	2885	7,77	4,47		2,20	2100	73	28,5
CMPI-1025-2T-4	2900	10,18	5,88		3,00	2830	77	37,6
CMPI-1025-4T	1400	4,03	2,32		1,10	3400	70	38,5
CMPI-1128-2T-4	2900	10,18	5,88		3,00	2220	77	41,5
CMPI-1128-2T-5.5	2870	13,60	7,82		4,00	3210	81	47,0
CMPI-1128-4T	1445	8,36	4,83		2,20	5000	74	39,0
CMPI-1128-6T	945	3,90	2,20		0,75	3300	60	28,5
CMPI-1231-4T-3	1445	8,36	4,83		2,20	4740	73	47,0
CMPI-1231-4T-4	1445	10,96	6,33		3,00	5910	75	49,0
CMPI-1231-4T-5.5	1440	14,10	8,12		4,00	6850	77	56,0
CMPI-1231-6T	955	6,42	3,71		1,50	5115	64	49,0
CMPI-1435-4T-4	1445	10,96	6,33		3,00	5560	76	53,0
CMPI-1435-4T-5.5	1440	14,10	8,12		4,00	6260	78	61,5
CMPI-1435-4T-7.5	1460		10,60	6,10	5,50	7210	80	75,5
CMPI-1435-6T	955	9,30	5,30		2,20	6400	66	58,5
CMPI-1640-4T-5.5	1440	14,10	8,12		4,00	7000	77	78,5
CMPI-1640-4T-7.5	1460		10,60	6,10	5,50	8035	80	92,5
CMPI-1640-4T-10 IE3	1465		13,90	8,06	7,50	9710	82	119,5
CMPI-1640-6T	955	9,30	5,30		2,20	8100	71	75,5
CMPI-1845-4T-7.5	1460		10,60	6,10	5,50	8000	82	93,5
CMPI-1845-4T-10 IE3	1465		13,90	8,06	7,50	10000	85	120,5
CMPI-1845-6T	955	9,30	5,30		2,20	7500	77	84,0
CMPI-2050-4T-10 IE3	1465		13,90	8,06	7,50	9000	83	150,0
CMPI-2050-4T-15 IE3	1470		20,90	12,10	11,00	12525	87	178,0
CMPI-2050-4T-20 IE3	1465		27,90	16,20	15,00	16500	89	189,0
CMPI-2050-6T	960	16,50	9,46		4,00	11000	79	146,0
CMPI-2563-6T IE3	975		28,20	16,30	15,00	21000	86	300,0

**Características acústicas**

Los valores indicados, se determinan mediante medidas de nivel de presión y potencia sonora en dB(A) obtenidas en campo libre a una distancia equivalente a dos veces la envergadura del ventilador más el diámetro de la turbina, con un mínimo de 1,5 mts.

Espectro de potencia sonora Lw(A) en dB(A) por banda de frecuencia en Hz

Modelo	63	125	250	500	1000	2000	4000	8000	Modelo	63	125	250	500	1000	2000	4000	8000
512-2	37	47	58	65	69	66	64	57	1128-6	35	45	56	63	67	64	62	55
512-4	30	40	51	58	62	59	57	50	1231-4-3	51	60	71	78	82	80	78	71
514-2	40	50	61	68	72	69	67	60	1231-4-4	53	62	73	80	84	82	80	73
514-4	33	43	54	61	65	62	60	53	1231-4-5.5	55	64	75	82	86	84	82	75
616-2	44	54	65	72	76	73	71	64	1231-6	42	51	62	69	73	71	69	62
616-4	36	46	57	64	68	65	63	56	1435-4-4	54	63	74	81	85	83	81	74
620-2	43	53	64	71	75	72	70	63	1435-4-5.5	56	65	76	83	87	85	83	76
620-4	36	46	57	64	68	65	63	56	1435-4-7.5	58	67	78	85	89	87	85	78
718-2	45	55	66	73	77	74	72	65	1435-6	44	53	64	71	75	73	71	64
718-4	38	48	59	66	70	67	65	58	1640-4-5.5	55	64	75	82	86	84	82	75
820-2	48	58	69	76	80	77	75	68	1640-4-7.5	58	67	78	85	89	87	85	78
820-4	41	51	62	69	73	70	68	61	1640-4-10	60	69	80	87	91	89	87	80
922-2-1.5	45	55	66	73	77	74	72	65	1640-6	49	58	69	76	80	78	76	69
922-2-2	46	56	67	74	78	75	73	66	1845-4-7.5	61	71	82	89	93	91	89	81
922-2-3	49	59	70	77	81	78	76	69	1845-4-10	64	74	85	92	96	94	92	84
922-4	41	51	62	69	73	70	68	61	1845-6	56	66	77	84	88	86	84	76
1025-2-3	48	58	69	76	80	77	75	68	2050-4-10	62	72	83	90	94	92	90	82
1025-2-4	52	62	73	80	84	81	79	72	2050-4-12.5	64	74	85	92	96	94	92	84
1025-4	45	55	66	73	77	74	72	65	2050-4-15	66	76	87	94	98	96	94	86
1128-2-4	52	62	73	80	84	81	79	72	2050-4-20	68	78	89	96	100	98	96	88
1128-2-5.5	56	66	77	84	88	85	83	76	2050-6	58	68	79	86	90	88	86	78
1128-4	49	59	70	77	81	78	76	69	2563-6	67	77	88	95	99	96	94	87

Dimensiones mm

CMPI-512...820

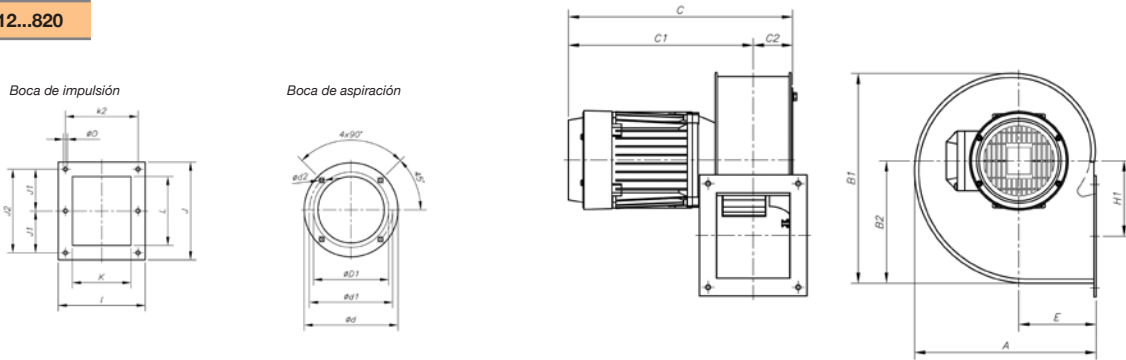

Modelo	A	B1	B2	C	C1	C2	øD1*	ød	ød1	ød2	E	H1	I	J	J1	J2	K	k2	L	øO
CMPI-512-2	185	206,5	118	251	212	39	112	140	132	M4	81	69	106	118	-	104,5	75	93	86	5,5
CMPI-512-4	185	206,5	118	249	210	39	112	140	132	M4	81	69	106	118	-	104,5	75	93	86	5,5
CMPI-514-2	225	254	150	281	236	45	140	169	151,5	M4	100	91	122	147	64	128	83	105	107	6,5
CMPI-514-4	225	254	150	261	216	45	140	169	151,5	M4	100	91	122	147	64	128	83	105	107	6,5
CMPI-616-2	258	297	173,5	320	264	56	160	204	180	M6	110	105,5	153	172	-	147	103	128	122	7
CMPI-616-4	258	297	173,5	283	227	56	160	204	180	M6	110	105,5	153	172	-	147	103	128	122	7
CMPI-620-2	298	347	202,5	321	265	56	200	247	230	M6	126	145,5	159	153	-	128	105	134	100	8
CMPI-620-4	298	347	202,5	283	227	56	200	247	230	M6	126	145,5	159	153	-	128	105	134	100	8
CMPI-718-2T	303,5	348	201	355	294	61	180	238	210	M6	129,5	122	169	192	85	170	115	145	146	9
CMPI-718-2M	303,5	348	201	355	245	61	180	238	210	M6	129,5	122	169	192	85	170	115	145	146	9
CMPI-718-4	303,5	348	201	331	270	61	180	238	210	M6	129,5	122	169	192	85	170	115	145	146	9
CMPI-820-2	322	377	223	369,5	301	68,5	200	247	230	M6	137,5	137	184	213	94,5	189	130	160	156	9
CMPI-820-4	322	377	223	345,5	277	68,5	200	247	230	M6	137,5	137	184	213	94,5	189	130	160	156	9

\* Diámetro nominal tubería recomendada

CMPI-922...1231

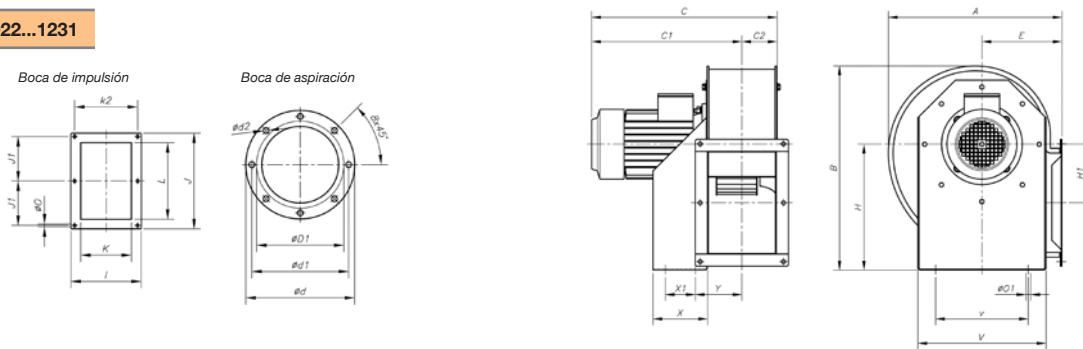

Modelo	A	B	C	C1	C2	øD1*	ød	ød1	ød2	E	H	H1	I	J	J1	K	k2	L	øO	øO1	V	v	X	X1	Y
CMPI-922-2T-1*5	388,5	455	382,5	309	73,5	224	278	256	M8	180	280	134	204	282,5	128	140	180	215	9,5	10,5	290	220	114	50	105
CMPI-922-2T-2	388,5	455	430,5	357	73,5	224	278	256	M8	180	280	134	204	282,5	128	140	180	215	9,5	10,5	290	220	114	50	105
CMPI-922-2T-3	388,5	455	430,5	357	73,5	224	278	256	M8	180	280	134	204	282,5	128	140	180	215	9,5	10,5	290	220	114	50	105
CMPI-922-4T	388,5	455	382,5	309	73,5	224	278	256	M8	180	280	134	204	282,5	128	140	180	215	9,5	10,5	290	220	114	50	105
CMPI-1025-2T-3	427	503	456	370	86	250	305	282	M8	197	310	144	229	312,5	145	165	205	250	9,5	12,5	315	228	134	74	115,5
CMPI-1025-2T-4	427	503	486	400	86	250	305	282	M8	197	310	144	229	312,5	145	165	205	250	9,5	12,5	315	228	134	74	115,5
CMPI-1025-4T	427	503	456	370	86	250	305	282	M8	197	310	144	229	312,5	145	165	205	250	9,5	12,5	315	228	134	74	115,5
CMPI-1128-2T-4	472	553	500,5	407	93,5	280	348	320	M8	216	340	152	244	364	170	180	220	296,5	9,5	12,5	348	245	144	95	122,5
CMPI-1128-2T-5*5	472	553	523,5	430	93,5	280	348	320	M8	216	340	152	244	364	170	180	220	296,5	9,5	12,5	348	245	144	95	122,5
CMPI-1128-4T	472	553	500,5	407	93,5	280	348	320	M8	216	340	152	244	364	170	180	220	296,5	9,5	12,5	348	245	144	95	122,5
CMPI-1128-6T	472	553	470,5	377	93,5	280	348	320	M8	216	340	152	244	364	170	180	220	296,5	9,5	12,5	348	245	144	95	122,5
CMPI-1231-4T-3	526	630	520,5	417	103,5	315	382	354	M8	238	390	179,5	264	382,5	180	200	240	320	11,5	13	382	322	183	140	126
CMPI-1231-4T-4	526	630	520,5	417	103,5	315	382	354	M8	238	390	179,5	264	382,5	180	200	240	320	11,5	13	382	322	183	140	126
CMPI-1231-4T-5*5	526	630	543,5	440	103,5	315	382	354	M8	238	390	179,5	264	382,5	180	200	240	320	11,5	13	382	322	183	140	126
CMPI-1231-6T	526	630	520,5	417	103,5	315	382	354	M8	238	390	179,5	264	382,5	180	200	240	320	11,5	13	382	322	183	140	126

\* Diámetro nominal tubería recomendada

Dimensiones mm

CMPI-1435...2563

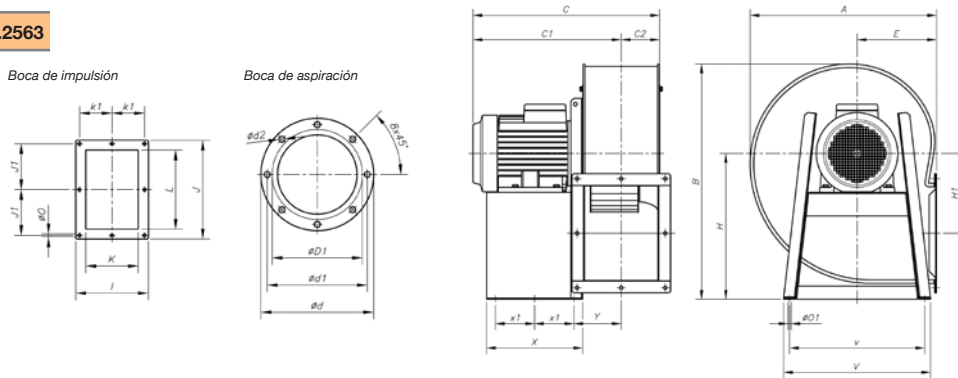

Modelo	A	B	C	C1	C2	øD1*	ød	ød1	ød2	E	H	H1	I	J	J1	K	k1	L	øO	øO1	V	v	X	X1	Y
CMPI-1435-4T-4	573,5	715	549	431	118	355	422	394	M8	250	445	242,5	292	342,5	159	228	133	280	11,5	12	456	420	333	136,5	150
CMPI-1435-4T-5'5	573,5	715	572	454	118	355	422	394	M8	250	445	242,5	292	342,5	159	228	133	280	11,5	12	456	420	333	136,5	150
CMPI-1435-4T-7'5	573,5	715	610	492	118	355	422	394	M8	250	445	242,5	292	342,5	159	228	133	280	11,5	12	456	420	333	136,5	150
CMPI-1435-6T	573,5	715	572	454	118	355	422	394	M8	250	445	242,5	292	342,5	159	228	133	280	11,5	12	456	420	333	136,5	150
CMPI-1640-4T-5'5	634	799	596	465	130	400	464	438	M8	270	495	271	336	404	185	250	150	321	11,5	12	500	460	327	133,5	162,5
CMPI-1640-4T-7'5	634	799	634	504	130	400	464	438	M8	270	495	271	336	404	185	250	150	321	11,5	12	500	460	327	133,5	162,5
CMPI-1640-4T-10	634	799	634	504	130	400	464	438	M8	270	495	271	336	404	185	250	150	321	11,5	12	500	460	327	133,5	162,5
CMPI-1640-6T	634	799	596	466	130	400	464	438	M8	270	495	271	336	404	185	250	150	321	11,5	12	500	460	327	133,5	162,5
CMPI-1845-4T-7'5	711	901	668	521	147	450	515	485	M8	302	560	305	370	444	202	284	164	361	11,5	12	538	502	340	140	179,5
CMPI-1845-4T-10	711	901	668	521	147	450	515	485	M8	302	560	305	370	444	202	284	164	361	11,5	12	538	502	340	140	179,5
CMPI-1845-6T	711	901	630	483	147	450	515	485	M8	302	560	305	370	444	202	284	164	361	11,5	12	538	502	340	140	179,5
CMPI-2050-4T-10	797	987	700,5	538	162,5	500	565	535	M10	345	610	313	411	544	250	315	182,5	451	11,5	12	653	615	435	188	196
CMPI-2050-4T-12'5	797	987	752,5	590	162,5	500	565	535	M10	345	610	313	411	544	250	315	182,5	451	11,5	12	653	615	435	188	196
CMPI-2050-4T-15	797	987	805,5	643	162,5	500	565	535	M10	345	610	313	411	544	250	315	182,5	451	11,5	12	653	615	435	188	196
CMPI-2050-4T-20	797	987	805,5	643	162,5	500	565	535	M10	345	610	313	411	544	250	315	182,5	451	11,5	12	653	615	435	188	196
CMPI-2050-6T	797	987	700,5	538	162,5	500	565	535	M10	345	610	313	411	544	250	315	182,5	451	11,5	12	653	615	435	188	196
CMPI-2563-6T	1030	1217	1047	836	211	630	710	675	M10	460	742	378	512	706	330	410	230	600	17	14	590	540	450	200	239

\* Diámetro nominal tubería recomendada

Curvas Características

Ver página 162

Accesorios

Ver apartado accesorios.



# CMRG

**Extractores centrífugos de media presión y simple aspiración con turbina con alabes hacia atrás, galvanizados en caliente, para trabajar en ambientes químicos, agresivos o marinos.**



**Ventilador:**

- Envoltorio en chapa de acero de gran robustez galvanizada en caliente
- Turbina con álabes a reacción, en chapa de acero de gran robustez, galvanizada en caliente
- Aro de aspiración galvanizado en caliente

**Motor:**

- Motores clase F, con rodamientos a bolas, protección IP55, excepto modelos monofásicos protección IP-54
- Motores de eficiencia IE3 para potencias iguales o superiores a 7,5kW, excepto monofásicos, 2 velocidades y 8 polos
- Monofásicos 230V.- 50Hz y trifásicos 230/400V.-50Hz.(hasta 4 kW) y 400/690V.-50Hz.(potencias superiores a 4 kW)
- Temperatura máxima del aire a transportar: -20°C.+ 120°C.

**Bajo demanda:**

- Bobinados especiales para diferentes tensiones y frecuencias
- Construcción ATEX para diferentes categorías
- Motores marinos para aplicaciones navales, con certificación para servicio esencial según diferentes entidades de clasificación (BV, DNV, LR)
- Construcción en acero inoxidable
- Motores marinos para aplicaciones navales, con certificación para servicio esencial según diferentes entidades de clasificación (BV, DNV, LR)
- Motores CE, NEMA, UL, CSA
- Motores de eficiencias IE2 e IE3 para cualquier potencia

**Acabado:**

- Anticorrosivo en acero galvanizado en caliente

**Código de pedido**

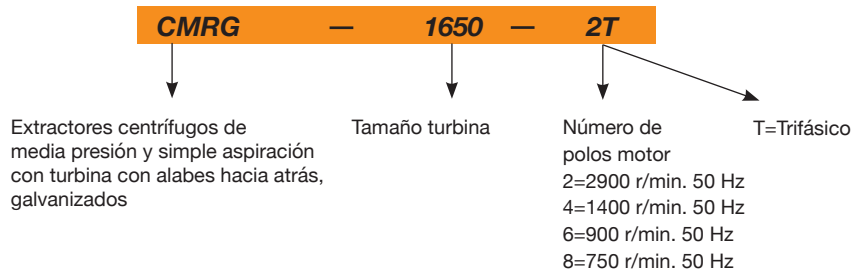

**Características técnicas**

Modelo	Velocidad (r/min)	Intensidad máxima admisible (A)			Potencia instalada (kW)	Caudal máximo (m³/h)	Nivel presión sonora dB(A)	Peso aprox. (Kg)
		230V	400V	690V				
CMRG-622-2T	2710	1,29	0,75		0,25	1040	74	11,6
CMRG-625-2T	2710	1,92	1,11		0,37	1280	75	13,7
CMRG-728-2T	2760	2,57	1,49		0,55	1800	76	17,6
CMRG-731-2T	2770	2,78	1,60		0,75	2350	77	22,8
CMRG-1031-2T	2770	5,44	3,13		1,50	5160	80	44,3
CMRG-1135-2T	2885	7,77	4,47		2,20	7800	83	54,9
CMRG-1240-2T	2870	13,60	7,82		4,00	11100	86	93,5
CMRG-1240-4T	1410	3,10	1,79		0,75	5800	71	70,5
CMRG-1445-2T	2870		14,50	8,41	7,50	16500	87	126,0
CMRG-1445-4T	1400	4,03	2,32		1,10	8030	72	92,5
CMRG-1650-2T IE3	2945		20,00	11,60	11,00	18850	89	210,0
CMRG-1650-4T	1430	5,96	3,44		1,50	10500	74	114,0
CMRG-1650-6T	945	3,90	2,20		0,75	7410	64	114,0
CMRG-1856-4T	1445	10,96	6,33		3,00	15150	79	152,0
CMRG-1856-6T	945	4,88	2,82		1,10	10050	70	146,5
CMRG-2063-4T	1440		11,60	6,72	5,50	24450	80	226,0
CMRG-2063-6T	955	6,42	3,71		1,50	16100	71	208,5
CMRG-2063-8T	705	5,63	3,25		1,10	11600	65	210,5
CMRG-2271-4T IE3	1470		20,90	12,10	11,00	34610	85	340,0



**Características técnicas**

Modelo	Velocidad (r/min)	Intensidad máxima admisible (A)			Potencia instalada (kW)	Caudal máximo (m³/h)	Nivel presión sonora dB(A)	Peso aprox. (Kg)
		230V	400V	690V				
CMRG-2271-6T	960	12,70	7,30		3,00	22750	76	293,5
CMRG-2271-8T	705	7,10	4,10		1,50	17360	69	275,5
CMRG-2380-4T IE3	1470		41,00	23,80	22,00	48000	83	431,0
CMRG-2380-6T IE3	975		14,80	8,58	7,50	30000	75	398,0
CMRG-2380-8T	705	12,82	7,40		3,00	22000	66	317,0
CMRG-2590-4T IE3	1480		69,20	40,10	37,00	54000	86	495,0
CMRG-2590-6T IE3	975		21,90	12,70	11,00	34000	76	400,0
CMRG-28100-4T IE3	1480		98,60	57,20	55,00	75000	87	618,0
CMRG-28100-6T IE3	980		35,90	20,80	18,50	48000	77	561,0

**Características acústicas**

Los valores indicados, se determinan mediante medidas de nivel de presión y potencia sonora en dB(A) obtenidas en campo libre a una distancia equivalente a dos veces la envergadura del ventilador más el diámetro de la turbina, con un mínimo de 1,5 mts.

Espectro de potencia sonora Lw(A) en dB(A) por banda de frecuencia en Hz

Modelo	63	125	250	500	1000	2000	4000	8000	Modelo	63	125	250	500	1000	2000	4000	8000
622-2T	59	72	72	85	80	80	80	73	1856-6	61	69	81	83	80	81	71	60
625-2T	60	73	73	86	81	81	81	74	2063-4	80	85	91	93	91	88	81	73
728-2T	61	74	74	87	82	82	82	75	2063-6	69	70	82	82	81	83	73	63
731-2T	62	75	75	88	83	83	83	76	2063-8	64	70	77	76	77	74	66	57
1031-2	65	78	78	91	86	86	86	79	2271-4	83	84	93	96	98	99	95	82
1135-2	72	79	77	89	87	93	92	79	2271-6	73	73	87	86	90	90	79	68
1240-2	68	83	81	93	90	94	96	83	2271-8	68	73	78	85	81	80	70	59
1240-4	56	70	76	79	79	80	70	59	2380-4	76	78	94	91	96	97	93	82
1445-2	73	85	83	95	93	97	99	89	2380-6	68	70	86	83	88	89	85	74
1445-4	59	72	78	83	80	83	78	64	2380-8	59	61	77	74	79	80	76	65
1650-2	73	81	85	99	97	99	99	88	2590-4	79	84	97	100	96	89	84	66
1650-4	64	74	82	84	83	85	76	66	2590-6	70	79	89	88	85	84	74	68
1650-6	53	65	72	77	73	69	62	54	28100-4	82	89	101	102	97	93	87	78
1856-4	69	78	91	87	90	91	85	71	28100-6	73	82	91	90	88	86	77	70

**Dimensiones mm**

CMRG-622...731

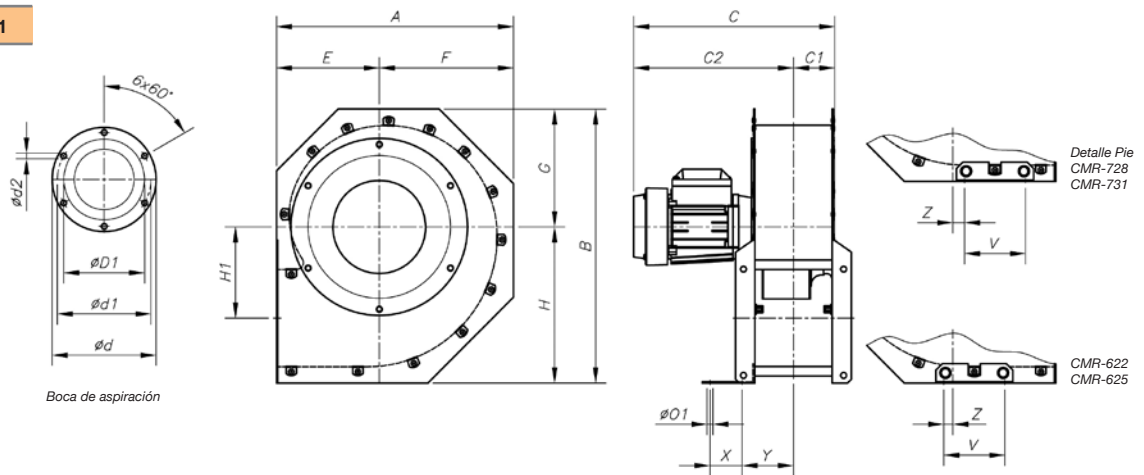

Modelo	A	B	C	C1	C2	$\phi D1^*$	$\phi d$	$\phi d1$	$\phi d2$	E	F	G	H	H1	$\phi O1$	V	X	Y	Z
CMRG-622-2T	364	415,5	338,5	64	274,5	162	284	256	9,5	160	204	178	237,5	141,5	9	95	50	80	14
CMRG-625-2T	407	457	343,5	66,5	277	160	315	282	9,5	183	224	195,5	261,5	155	9	95	50	82,5	6
CMRG-728-2T	453,5	506,5	357,5	72,5	285	192	354	320	9,5	205	248,5	216	290,5	176	9	95	50	88,2	6,5
CMRG-731-2T	507	564	374	70	304	192	382	354	9,5	230	277	240,5	323,5	197,5	9	95	50	85,2	20,5

\* Diámetro nominal tubería recomendada

Dimensiones mm

CMRG-1031...2271

Boca de aspiración

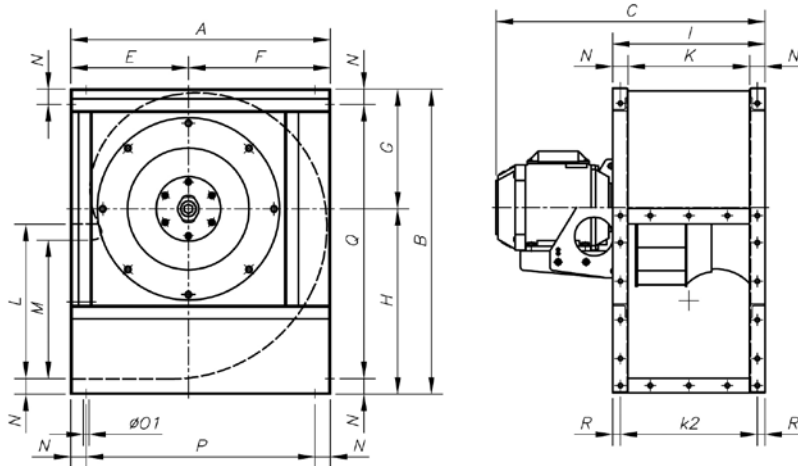
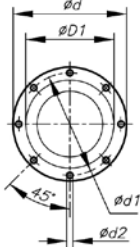

Modelo	A	B	C	$\phi D1^*$	$\phi d$	$\phi d1$	$\phi d2$	E	F	G	H	I	K	k2	L	M	N	$\phi O1$	P	Q	R
CMRG-1031-2T	542	626	573,5	315	383	356	M8	250	292	245	381	320	250	285	315	276	35	11	472	556	17,5
CMRG-1135-2T	600	696	656	355	425	398	M8	275	325	273	423	350	280	315	355	310	35	11	530	626	17,5
CMRG-1240-2T	673	790	728	400	472	444	M10	305	368	310	480	395	315	355	400	358	40	11	593	710	20
CMRG-1240-4T	673	790	590	400	472	444	M10	305	368	310	480	395	315	355	400	358	40	11	593	710	20
CMRG-1445-2T	765	880	810	450	522	494	M10	350	415	339	541	445	355	403	450	404	45	11	675	790	21
CMRG-1445-4T	765	880	649	450	522	494	M10	350	415	339	541	445	355	403	450	404	45	11	675	790	21
CMRG-1650-2T	832	970	961	500	582	555	M10	375	457	378	592	490	400	450	500	445	45	13	742	880	20
CMRG-1650-4T	832	970	715	500	582	555	M10	375	457	378	592	490	400	450	500	445	45	13	742	880	20
CMRG-1650-6T	832	970	695	500	582	555	M10	375	457	378	592	490	400	450	500	445	45	13	742	880	20
CMRG-1856-4T	925	1084	832	560	645	615	M10	415	510	426	658	550	450	500	560	493	50	13	825	984	25
CMRG-1856-6T	925	1084	771	560	645	615	M10	415	510	426	658	550	450	500	560	493	50	13	825	984	25
CMRG-2063-4T	1037	1218	973	630	720	688	M10	465	572	477	741	620	500	560	630	530	60	13	917	1098	30
CMRG-2063-6T	1037	1218	893	630	720	688	M10	465	572	477	741	620	500	560	630	530	60	13	917	1098	30
CMRG-2063-8T	1037	1218	893	630	720	688	M10	465	572	477	741	620	500	560	630	530	60	13	917	1098	30
CMRG-2271-4T	1173	1375	1126	710	800	768	M12	525	648	538	837	690	560	625	710	603	65	13	1043	1245	32,5
CMRG-2271-6T	1173	1375	1039	710	800	768	M12	525	648	538	837	690	560	625	710	603	65	13	1043	1245	32,5
CMRG-2271-8T	1173	1375	1002	710	800	768	M12	525	648	538	837	690	560	625	710	603	65	13	1043	1245	32,5

\* Diámetro nominal tubería recomendada

CMRG-2380...28100

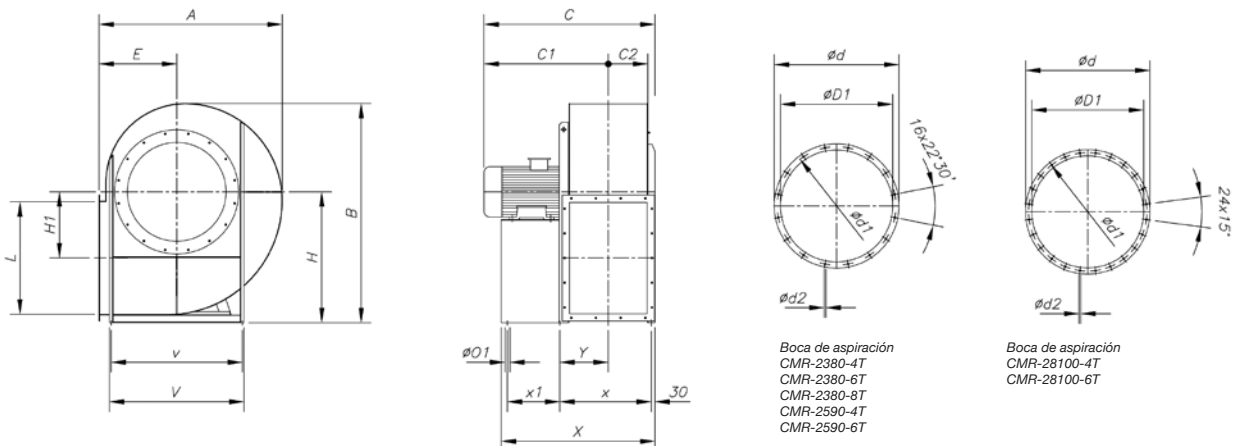

Modelo	A	B	C	C1	C2	$\phi D1^*$	$\phi d$	$\phi d1$	$\phi d2$	E	H	H1	L	$\phi O1$	V	v	X	x	x1	Y
CMRG-2380-4T	1350	1660	1245	899	286	808	906	861	11,5	560	1000	500	800	17	930	870	1102,5	667,5	370	352,5
CMRG-2380-6T	1350	1660	1030	744	286	808	906	861	11,5	560	1000	500	800	17	930	870	1102,5	667,5	370	352,5
CMRG-2380-8T	1350	1660	1035	681	286	808	906	861	11,5	560	1000	500	800	17	930	870	1102,5	667,5	370	352,5
CMRG-2590-4T	1495	1785	1390	1012	321	908	1008	958	14	630	1060	535	900	19	1030	970	1246	751	425	393
CMRG-2590-6T	1495	1785	1235	857	321	908	1008	958	14	630	1060	535	900	19	1030	970	1121	721	340	373
CMRG-28100-4T	1680	1990	1470	1051	362	1008	1108	1067	14	710	1180	610	1000	19	1130	1060	1378	843	460	454
CMRG-28100-6T	1680	1990	1395	976	362	1008	1108	1067	14	710	1180	610	1000	19	1130	1060	1278	823	385	434

\* Diámetro nominal tubería recomendada

Dimensiones mm

Boca Impulsión

CMRG-1031  
CMRG-1135  
CMRG-2590  
CMRG-28100

CMRG-622  
CMRG-625  
CMRG-728  
CMRG-731

CMRG-1240  
CMRG-1445  
CMRG-1650

CMRG-1856

CMRG-2063

CMRG-2271

CMRG-2380

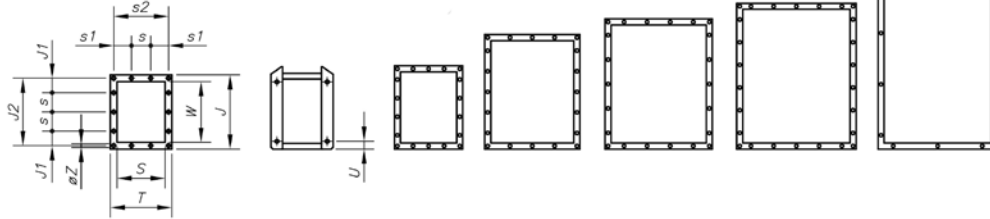

Modelo	T	J	J1	J2	S	s	s1	s2	W	Øz	U
CMRG-622	180	191,5	-	165	120	-	-	156	150	9	12
CMRG-625	185	207,5	-	181,5	125	-	-	161	167,5	9	12
CMRG-728	196,5	234,5	-	202	136,5	-	-	172,5	187,5	9	12
CMRG-731	190,5	250,5	-	227,5	130,5	-	-	166,5	211	9	12
CMRG-1031	320	385	75	350	250	100	92,5	285	315	9	-
CMRG-1135	350	425	95	390	280	100	107,5	315	355	9	-
CMRG-1240	395	480	70	440	315	100	77,5	355	400	11	-
CMRG-1445	445	540	99	498	355	100	102,5	403	450	11	-
CMRG-1650	490	590	88	550	400	125	100	450	500	11	-
CMRG-1856	550	660	55	610	450	125	125	500	560	13	-
CMRG-2063	620	750	95	690	500	125	92,5	560	630	13	-
CMRG-2271	690	840	75	775	560	125	62,5	625	710	13	-
CMRG-2380	680	920	160	871	560	200	140	639	800	14	-
CMRG-2590	750	1020	84	968	630	200	54	708	900	14	-
CMRG-28100	830	1120	138,5	1077	710	200	92,5	785	1000	14	-

Curvas Características

Q= Caudal en m³/h, m³/s y cfm.

Pe= Presión estática en mmH2O, Pa e inwg.

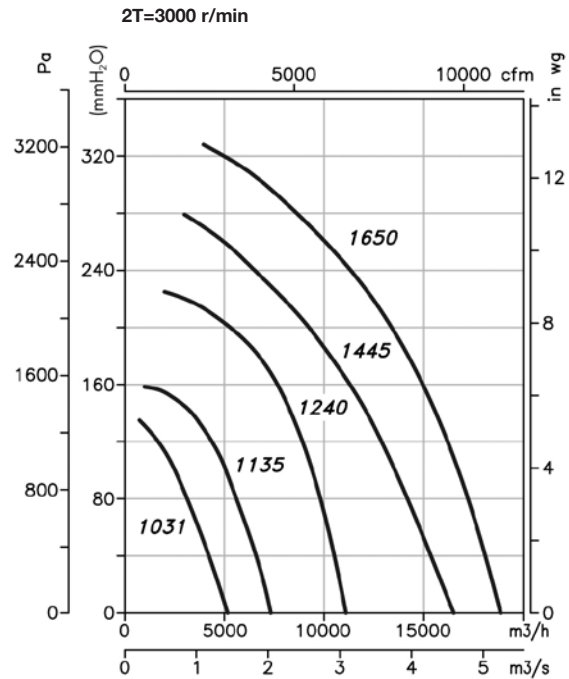
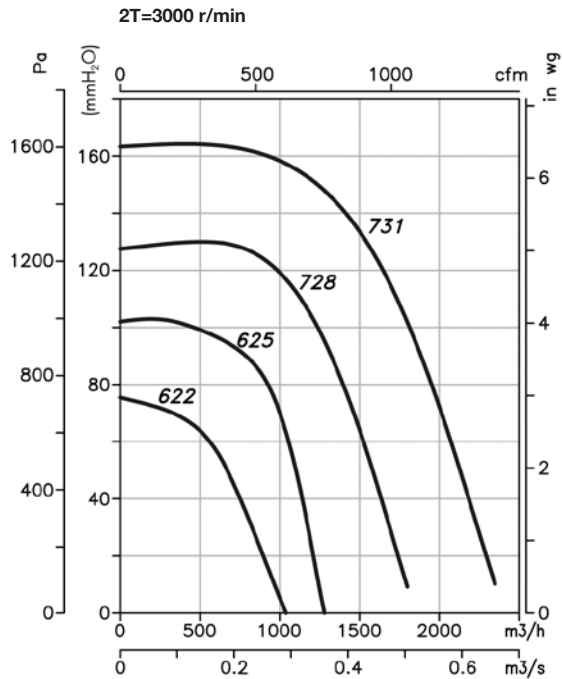

**Curvas Características**

Q= Caudal en m<sup>3</sup>/h, m<sup>3</sup>/s y cfm.

Pe= Presión estática en mmH<sub>2</sub>O, Pa e inwg.

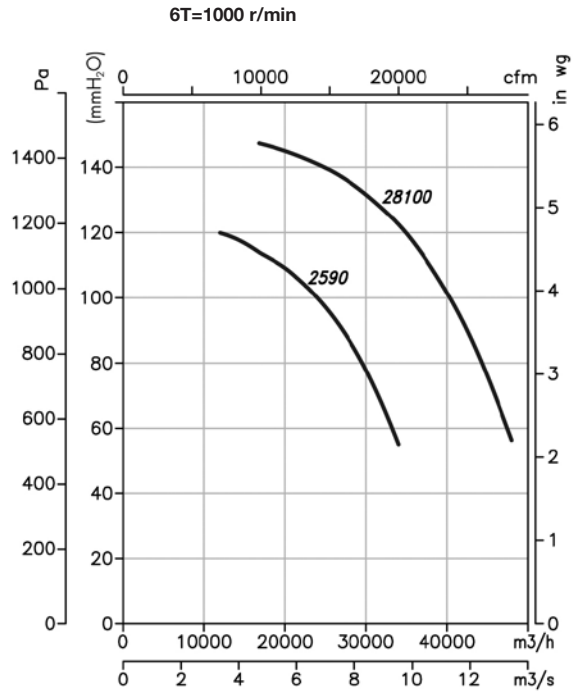
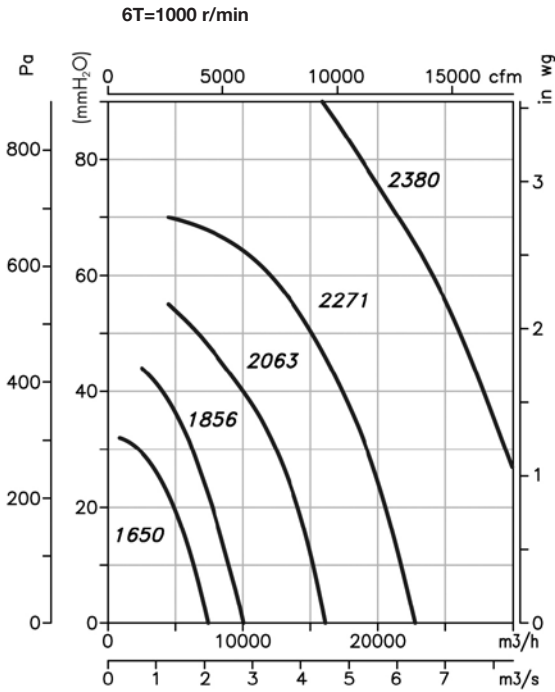
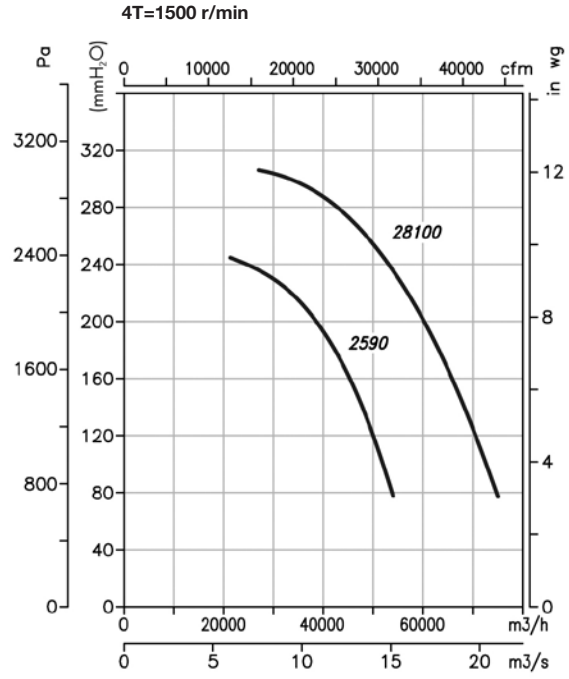
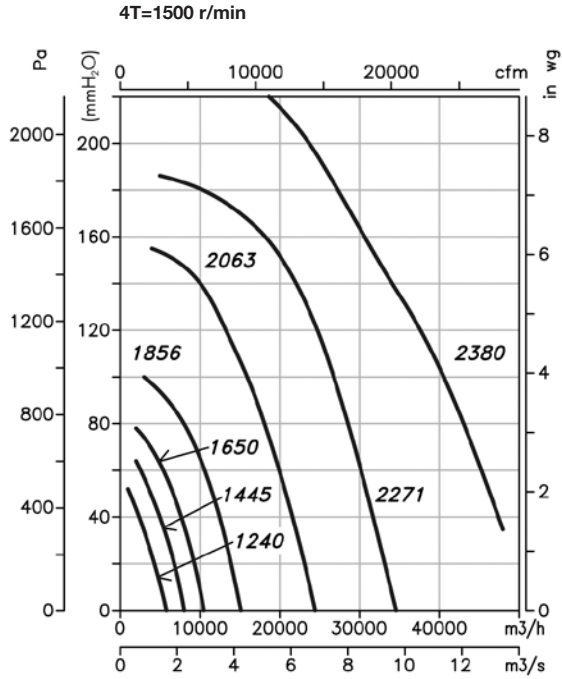

**Curvas Características**

Q= Caudal en m<sup>3</sup>/h, m<sup>3</sup>/s y cfm. Pe= Presión estática en mmH<sub>2</sub>O, Pa e inwg.

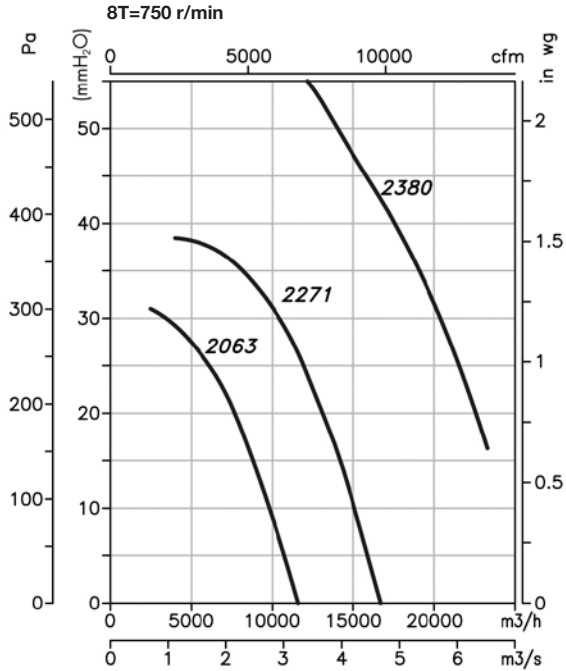

**Orientaciones**

Suministro standard LG 270  
Modelos 2380, 2590 y 28100 orientación fija LG 270 (otras orientaciones sólo bajo demanda)

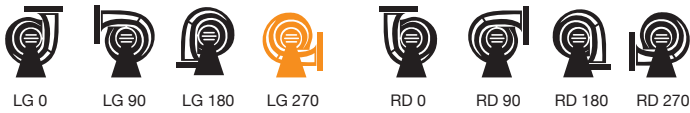

**Accesorios**

Ver apartado accesorios.



# CPV

## Ventiladores centrífugos anticorrosivos de simple aspiración fabricados en polipropileno



Estético y moderno diseño

### Ventilador:

- Envoltorio en polipropileno
- Turbina con álabes hacia delante, en polipropileno

### Motor:

- Motores de eficiencia IE2 para potencias iguales o superiores a 0,75kW e inferiores a 7,5kW, excepto monofásicos, 2 velocidades y 8 polos
- Motores de eficiencia IE3 para potencias iguales o superiores a 7,5kW, excepto monofásicos, 2 velocidades y 8 polos
- Motores clase F, con rodamientos a bolas, protección IP55
- Trifásicos 230/400V.-50Hz.(hasta 4 kW) y 400/690V.-50Hz.(potencias superiores a 4 kW)
- Temperatura máxima del aire a transportar: -20°C.+ 70°C.

### Acabado:

- Anticorrosivo en material plástico

### Bajo demanda:

- Bobinados especiales para diferentes tensiones
- Certificación ATEX Categoría 3
- Motores de eficiencias IE2 e IE3 para cualquier potencia

### Código de pedido

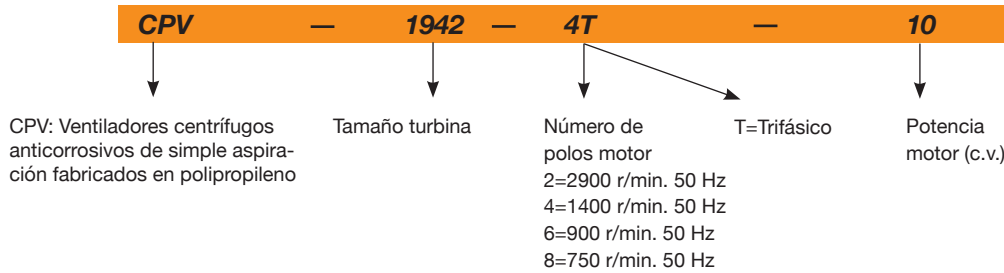

### Características técnicas

Modelo	Velocidad (r/min)	Intensidad máxima admisible (A)			Potencia instalada (kW)	Caudal máximo (m³/h)	Nivel presión sonora dB(A)	Peso aprox. (Kg)
		230V	400V	690V				
CPV-815-2T	2710	1,92	1,11		0,37	950	75	14,0
CPV-815-4T	1350	1,52	0,88		0,25	450	58	14,0
CPV-1020-2T	2770	2,78	1,60		0,75	2000	81	19,5
CPV-1020-4T	1350	1,52	0,88		0,25	1250	65	19,5
CPV-1020-6T	900	1,51	0,87		0,25	750	53	19,5
CPV-1325-2T	2885	7,77	4,47		2,20	3250	87	27,0
CPV-1325-4T	1370	2,02	1,17		0,37	2300	69	27,0
CPV-1325-6T	900	1,51	0,87		0,25	1400	59	27,0
CPV-1630-4T	1430	5,96	3,44		1,50	4500	75	34,5
CPV-1630-6T	900	2,99	1,73		0,55	2700	63	34,5
CPV-1840-4T	1445	10,96	6,33		3,00	6000	70	48,0
CPV-1840-6T	945	4,88	2,82		1,10	4200	65	42,0
*CPV-1942-4T-7,5	1440		11,60	6,72	5,50	8500	79	66,0
*CPV-1942-4T-10 IE3	1465		13,90	8,06	7,50	10500	84	93,0
*CPV-1942-6T	955	9,30	5,30		2,20	7000	75	49,0
*CPV-1942-8T	705	7,10	4,10		1,50	5500	70	56,0
CPV-2045-4T IE3	1465		13,90	8,06	7,50	10400	78	118,0
CPV-2045-6T	960	12,70	7,30		3,00	7000	72	88,0
CPV-1335-2T	2880		10,50	6,09	5,50	4700	84	91,0
CPV-1160-4T IE3	1470		20,90	12,10	11,00	8000	83	268,0
CPV-2060-4T IE3	1470		20,90	12,10	11,00	12000	81	270,0
CPV-2160-4T IE3	1465		27,90	16,20	15,00	15500	77	299,0
*CPV-720-2T	2710	1,92	1,11		0,37	525	75	10,0
*CPV-825-2T	2860	4,20	2,40		1,10	1140	79	17,0
*CPV-930-2T	2885	7,77	4,47		2,20	1750	84	24,0

\*Sólo admiten orientación LG

**Características acústicas**

Los valores indicados, se determinan mediante medidas de nivel de presión y potencia sonora en dB(A) obtenidas en campo libre a una distancia equivalente a dos veces la envergadura del ventilador más el diámetro de la turbina, con un mínimo de 1,5 mts.

**Espectro de potencia sonora Lw(A) en dB(A) por banda de frecuencia en Hz**

Modelo	63	125	250	500	1000	2000	4000	8000	Modelo	63	125	250	500	1000	2000	4000	8000
815-2	56	69	77	81	81	77	73	65	1942-4-10	80	90	92	95	94	94	92	83
815-4	39	52	60	64	64	60	56	48	1942-6	71	81	83	86	85	85	83	74
1020-2	62	75	83	87	87	83	79	71	1942-8	66	76	78	81	80	80	78	69
1020-4	46	59	67	71	71	67	63	55	2045-4	63	76	84	88	89	85	81	72
1020-6	34	47	55	59	59	55	51	43	2045-6	57	70	78	82	83	79	75	66
1325-2	70	83	91	95	96	92	88	79	1030	58	71	79	83	84	80	76	67
1325-4	52	65	73	77	78	74	70	61	1335	67	80	88	92	93	89	85	76
1325-6	42	55	63	67	68	64	60	51	1160	68	81	89	93	94	90	86	77
1630-4	60	73	81	85	86	82	78	69	2060	66	79	87	91	92	88	84	75
1630-6	48	61	69	73	74	70	66	57	2160	64	77	85	89	89	85	81	73
1840-4	55	68	76	80	81	77	73	64	720	56	69	77	81	81	77	73	65
1840-6	50	63	71	75	76	72	68	59	825	60	73	81	85	85	81	77	69
1942-4-7,5	75	85	87	90	89	89	87	78	930	65	78	86	90	90	86	82	74

**Dimensiones mm**

**CPV-720...1942**

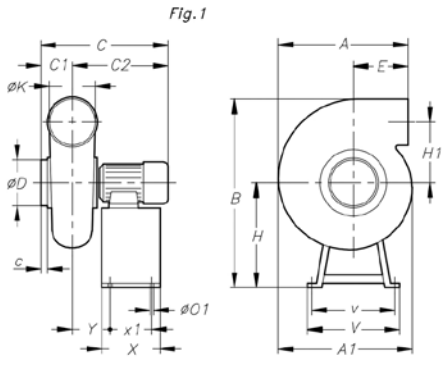

Modelo	Fig.	A	A1	B	C	C1	C2	c	øD	E	H	H1	øK	øO1	V	v	X	x1	Y
CPV-720	1	375	-	486	350	80	270	45	90	212	311	130	90	6	340	320	180	160	92
CPV-815	1	307	335	521	360	100	260	30	125	100	281	177,5	125	8	355	335	180	160	90
CPV-825	1	445	-	552	433	110	323	55	125	218	320	170	125	6	340	320	180	160	103
CPV-930	1	540	-	678	477	100	377	40	160	262	390	205	160	6	420	400	240	160	137
CPV-1020-2T	1	340	397	593	445,5	116	329,5	32	160	100	290	223	160	8	355	335	180	160	127,5
CPV-1020-4/6T	1	340	397	584	422,5	116	306,5	32	160	100	281	223	160	8	355	335	180	160	122,5
CPV-1325-2T	1	413	505	735	494	130	364	35	200	103	370	265	200	8	400	380	180	160	125
CPV-1325-4/6T	1	413	505	716	432,5	130	302,5	35	200	103	351	265	200	8	400	380	180	160	113,5
CPV-1630-4T	1	480	602	890	536,5	145	391,5	35	250	117	440	323	250	8	450	430	240	220	142,5
CPV-1630-6T	1	480	602	880	503	145	358	35	250	117	430	323	250	8	450	430	240	220	138
CPV-1942-4T	1	580	750	1170	730,5	210	520,5	60	315	130	600	412,5	315	8	600	564	350	314	181,5
CPV-1942-6/8T	1	580	750	1150	679,5	210	469,5	60	315	130	580	412,5	315	8	600	564	350	314	204

**CPV-1030...2045**

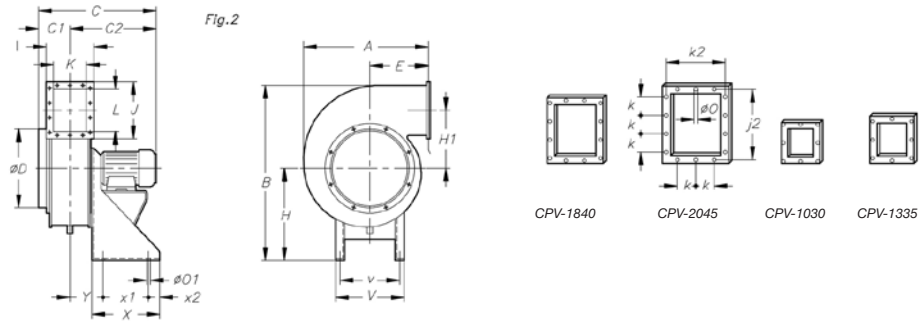

Modelo	Fig.	A	B	C	C1	C2	øD	E	H	H1	I	J	J2	øK	k	k2	L	øO	øO1	V	v	X	x1	x2	Y
CPV-1335	2	566	788	-	175	-	225	255	452	246	240	256	226	160	100	210	180	9	12	320	285	-	200	50	140
CPV-1840-4T	2	628	819	660	210	450	355	275	420	259	305	356	326	225	100	275	280	9	12	320	285	300	200	50	170
CPV-1840-6T	2	628	809	630	210	420	355	275	410	259	305	356	326	225	100	275	280	9	12	320	285	300	200	50	170
CPV-2045	2	724	1020	810	245	565	400	300	542	310	362	421	381	270	100	322	335	9	12	350	315	350	250	50	197

Dimensiones mm

CPV-1160...2160

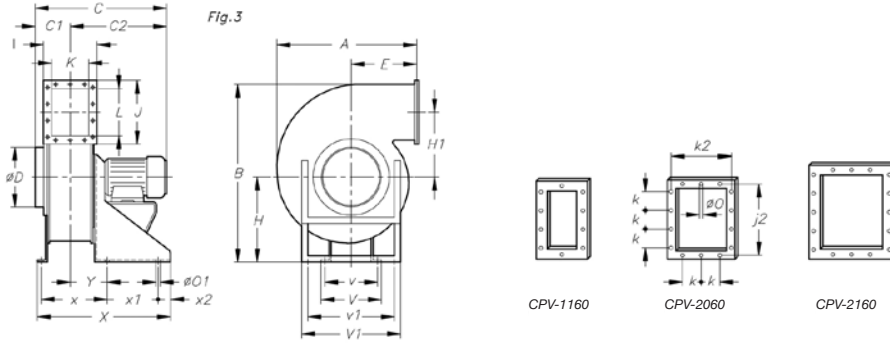

Modelo	Fig.	A	B	C	C1	C2	øD	E	H	H1	I	J	J2	øK	k	k2	L	øO	øO1	V	V1	v	v1	X	x	x1	x2	Y
CPV-1160	3	937	1296	-	210	-	355	410	720	421	275	416	366	155	100	225	310	9	14	500	790	450	670	710	265	360	60	155
CPV-2060	3	937	1296	-	270	-	400	410	720	421	395	416	366	275	100	345	310	9	14	500	790	450	670	855	410	360	60	215
CPV-2160	3	981	1356	-	285	-	600	414	720	438,5	455	501	451	335	100	405	395	9	14	500	790	450	670	915	470	360	60	240

Curvas características

Q= Caudal en m<sup>3</sup>/h, m<sup>3</sup>/s y cfm.

Pe= Presión estática en mmH<sub>2</sub>O, Pa e inwg.

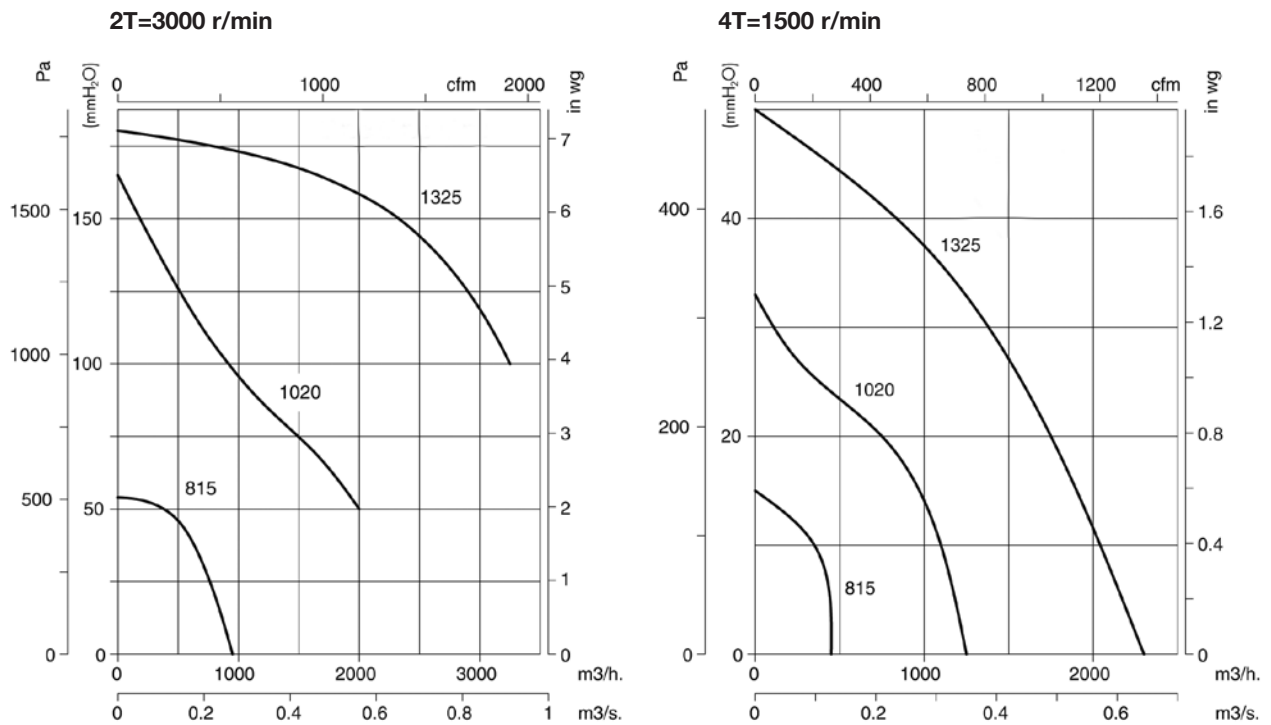



**Curvas características**

Q= Caudal en m<sup>3</sup>/h, m<sup>3</sup>/s y cfm.

Pe= Presión estática en mmH<sub>2</sub>O, Pa e in wg.

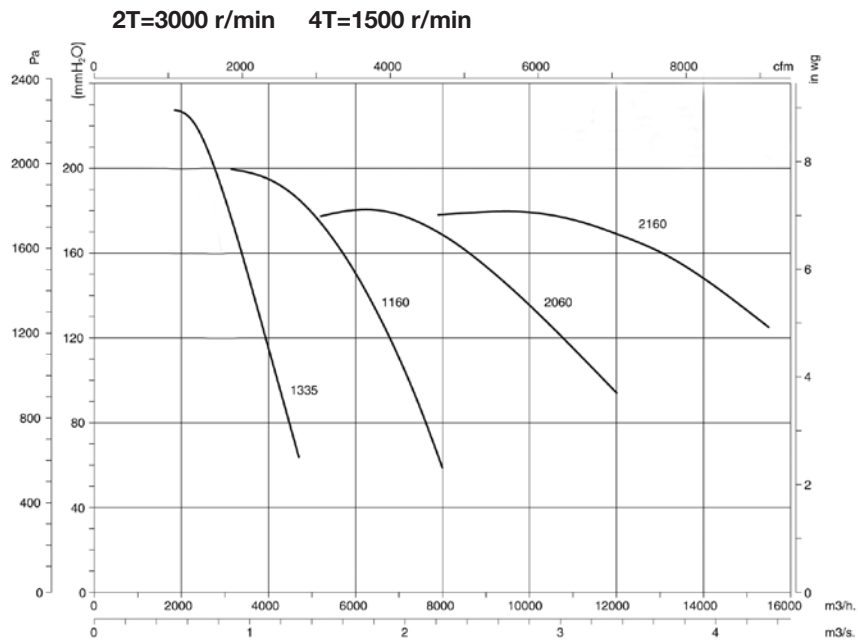
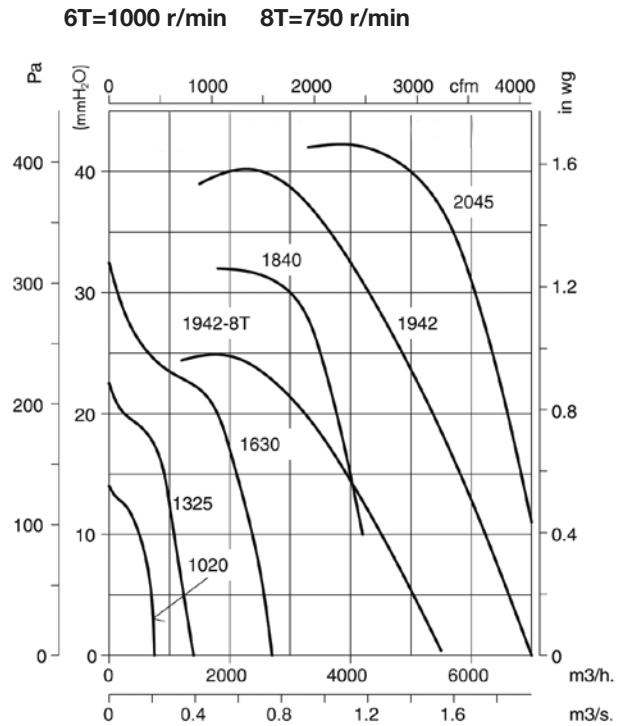
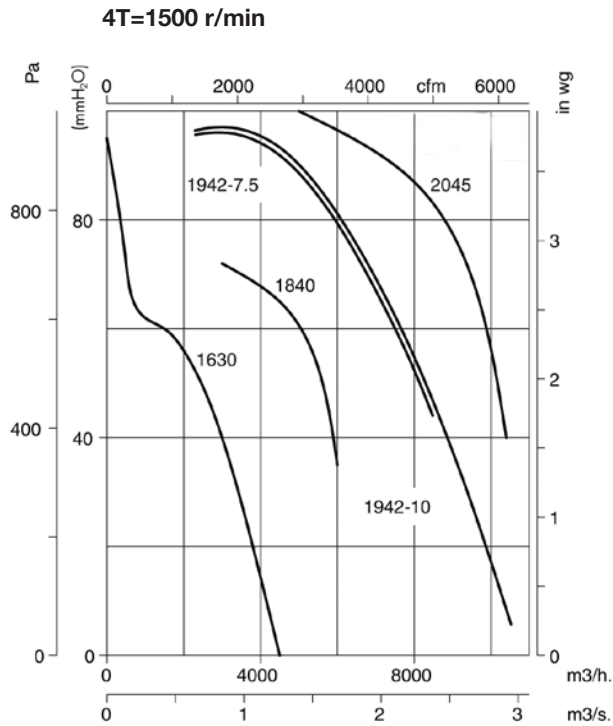

**Curvas características**

Q= Caudal en m<sup>3</sup>/h, m<sup>3</sup>/s y cfm.

Pe= Presión estática en mmH<sub>2</sub>O, Pa e inwg.

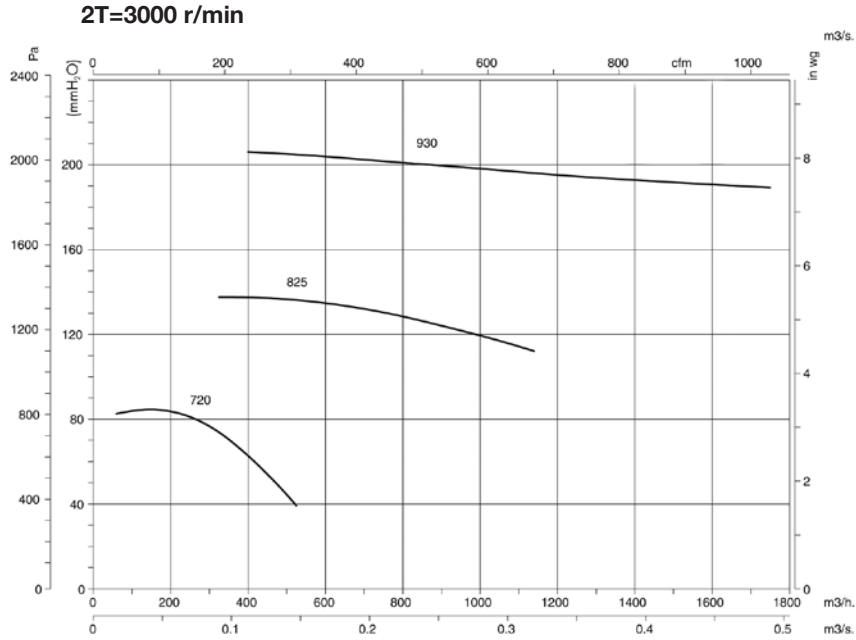

**Orientaciones**

Suministro standard LG 90



**Accesorios**

Ver apartado accesorios.





# CMRH

**Ventiladores accionados a transmisión, equipados con motor eléctrico, conjunto de poleas, correas y protectores normalizados según norma y ISO-13857:2008, y cajón calorifugado con fibra mineral de 150 mm, para trabajo horizontal**



Engrasadores externos para facilitar el mantenimiento

**Ventilador:**

- Estructura en chapa de acero de gran espesor
- Turbina con álabes a reacción, en chapa de acero de gran robustez
- Grupo de transmisión con rodamientos y soporte en fundición

**Motor:**

- Motores de eficiencia IE2 para potencias iguales o superiores a 0,75kW e inferiores a 7,5kW, excepto monofásicos, 2 velocidades y 8 polos
- Motores de eficiencia IE3 para potencias iguales o superiores a 7,5kW, excepto monofásicos, 2 velocidades y 8 polos.
- Motores clase F, con rodamientos a bolas, protección IP55
- Trifásicos 230/400V-50Hz (hasta 4kW) y 400/690V-50Hz (potencias superiores a 4kW)

- Temperatura máxima del aire a transportar: -20°C + 300°C

**Acabado:**

- Tratamiento con pintura anticorrosiva

**Bajo demanda:**

- Bobinados especiales para diferentes tensiones
- Ventilador en acero refractario para temperaturas de hasta 400°C
- Ejecución para trabajo vertical
- Motores de eficiencias IE2 e IE3 para cualquier potencia

## Código de pedido

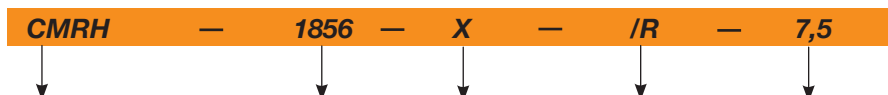

CMRH: Ventiladores accionados a transmisión, cajón calorifugado con fibra mineral de 150 mm, para trabajo horizontal

Tamaño turbina

Accionada a transmisión

Equipada con turbina de refrigeración

Potencia motor (CV)

## Características técnicas

Modelo	Velocidad (r/min)	Intensidad máxima admisible (A)			Potencia instalada (kW)	Caudal máximo (m³/h)	Nivel presión sonora dB(A)	Peso aprox. (Kg)
		230V	400V	690V				
CMRH-1445-X/R-3	1700	8,36	4,83		2,20	9620	79	203
CMRH-1445-X/R-4	1910	10,96	6,33		3,00	10810	81	207
CMRH-1445-X/R-5.5	2120	14,10	8,12		4,00	12000	83	226
CMRH-1650-X/R-4	1530	10,96	6,33		3,00	9910	80	212
CMRH-1650-X/R-5.5	1720	14,10	8,12		4,00	11140	82	231
CMRH-1650-X/R-7.5	1910		11,60	6,72	5,50	12370	84	250
CMRH-1856-X/R-5.5	1365	14,10	8,12		4,00	14210	79	241
CMRH-1856-X/R-7.5	1535		11,60	6,72	5,50	15980	81	260
CMRH-1856-X/R-10 IE3	1705		14,20	8,20	7,50	17780	83	273
CMRH-2063-X/R-7.5	1365		11,60	6,72	5,50	22860	82	265
CMRH-2063-X/R-10 IE3	1515		14,20	8,20	7,50	25370	84	278
CMRH-2063-X/R-15 IE3	1700		20,20	11,60	11,00	28470	86	305
CMRH-2271-X/R-15 IE3	1370		20,20	11,60	11,00	32300	87	350
CMRH-2271-X/R-20 IE3	1540		27,50	15,90	15,00	36300	90	375
CMRH-2380-X/R-25 IE3	1280		35,00	20,00	18,50	43885	83	405
CMRH-2380-X/R-30 IE3	1365		42,00	24,00	22,00	46800	85	422

Dimensiones mm

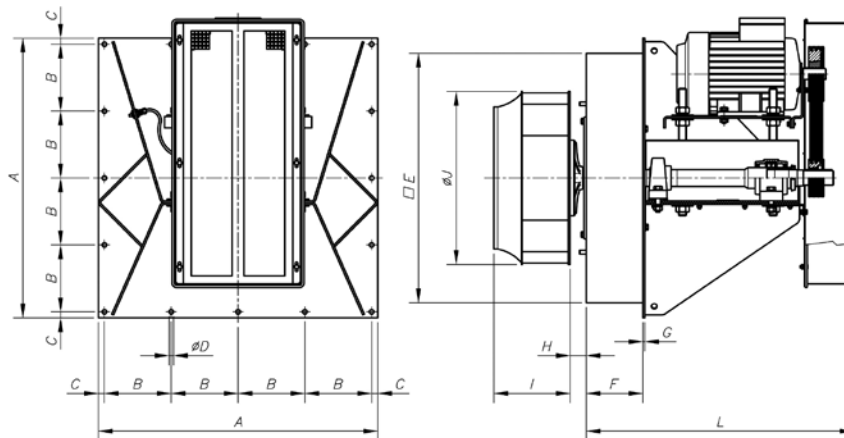

Modelo	A	B	C	øD	E	F	G	H	I	øJ	L
CMRH-1445-X/R-3	740	177	16	12	660	150	5	43	202	458	710
CMRH-1445-X/R-4	740	177	16	12	660	150	5	43	202	458	710
CMRH-1445-X/R-5'5	740	177	16	12	660	150	5	43	202	458	710
CMRH-1650-X/R-4	740	177	16	12	660	150	5	43	224	508	710
CMRH-1650-X/R-5'5	740	177	16	12	660	150	5	43	224	508	710
CMRH-1650-X/R-7'5	740	177	16	12	660	150	5	43	224	508	710
CMRH-1856-X/R-4	800	192	16	12	720	150	5	43	245,5	573	816
CMRH-1856-X/R-5'5	800	192	16	12	720	150	5	43	245,5	573	816
CMRH-1856-X/R-7'5	800	192	16	12	720	150	5	43	245,5	573	816
CMRH-2063-X/R-7'5	800	192	16	12	720	150	5	43	274	644	816
CMRH-2063-X/R-10	800	192	16	12	720	150	5	43	274	644	816
CMRH-2063-X/R-15	800	192	16	12	720	150	5	43	274	644	816
CMRH-2271-X/R-15	970	233	20	14	870	150	5	43	295	719	817
CMRH-2271-X/R-20	970	233	20	14	870	150	5	43	295	719	817
CMRH-2380-X/R-25	970	232,5	20	14	870	150	5	53,5	400	810	902
CMRH-2380-X/R-30	970	232,5	20	14	870	150	5	53,5	400	810	902

Accesorios

Ver apartado accesorios.



**Curvas Características**

Q= Caudal en m<sup>3</sup>/h, m<sup>3</sup>/s y cfm

Pe= Presión estática en mmH<sub>2</sub>O, Pa e inwg

**CMRH 1445**

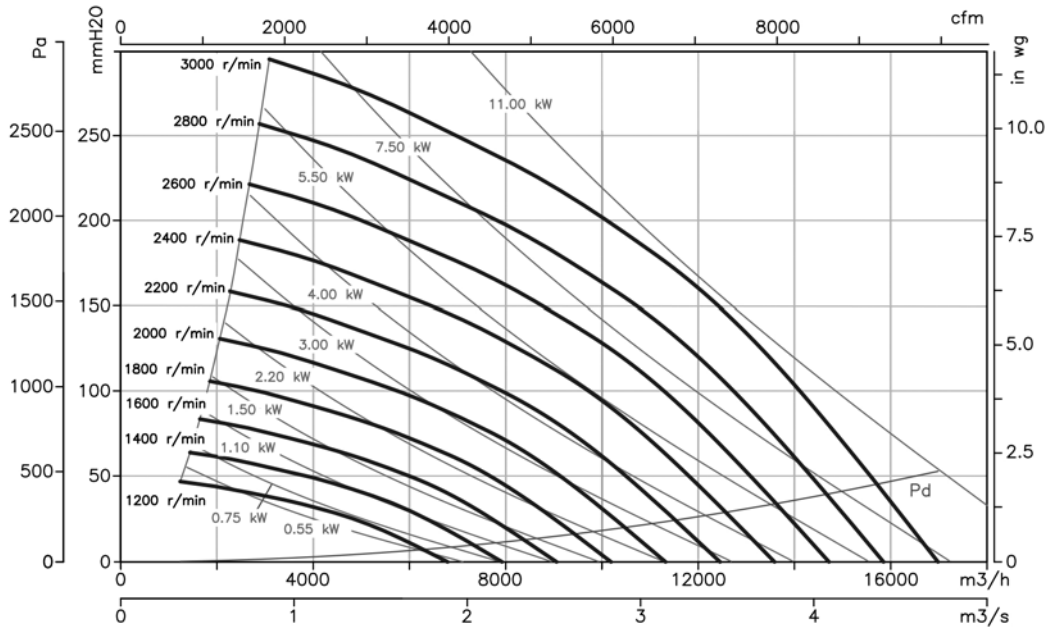

**CMRH 1650**

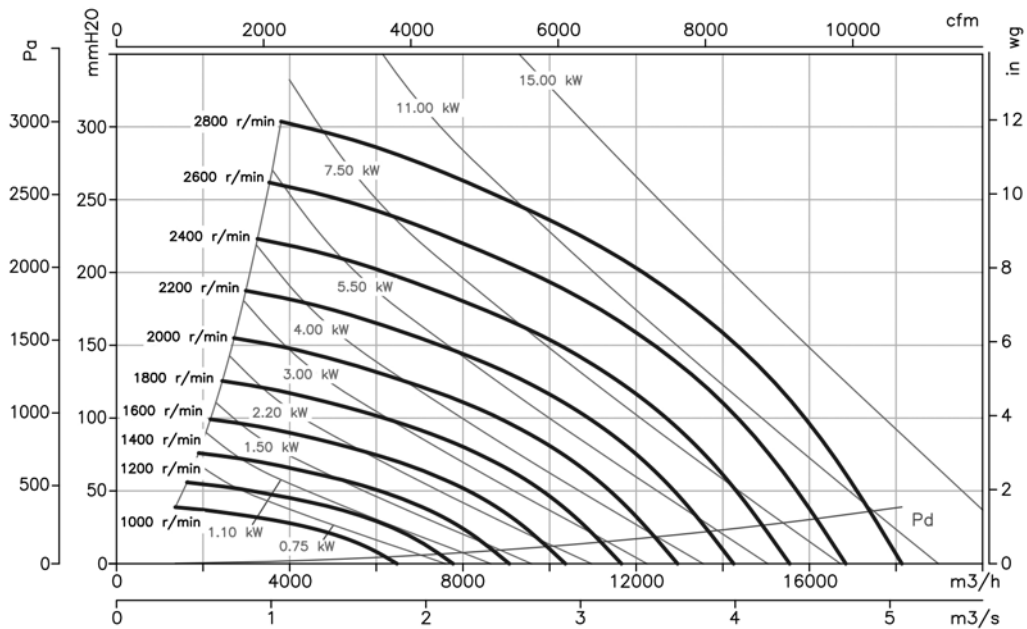

**Curvas Características**

Q= Caudal en m<sup>3</sup>/h, m<sup>3</sup>/s y cfm

Pe= Presión estática en mmH<sub>2</sub>O, Pa e inwg

**CMRH 1856**

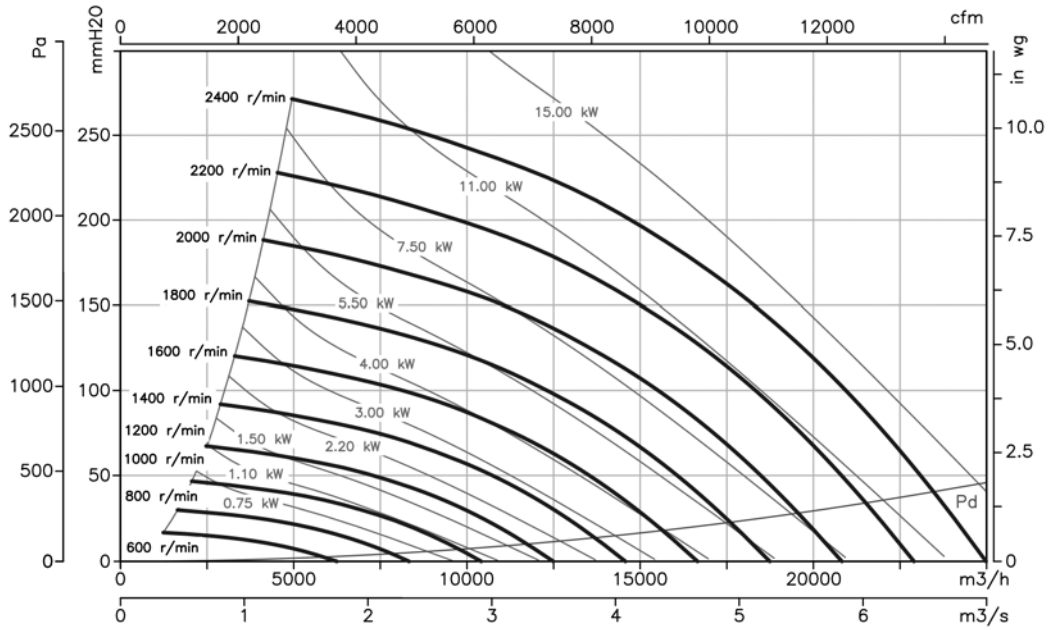

**CMRH 2063**

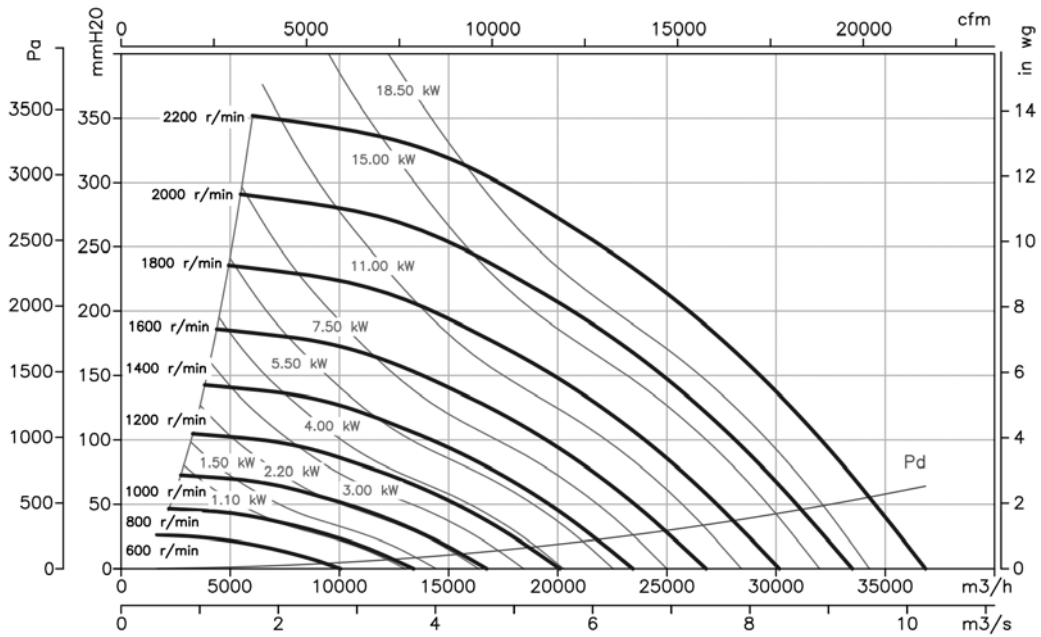

**Curvas Características**

Q= Caudal en m<sup>3</sup>/h, m<sup>3</sup>/s y cfm

Pe= Presión estática en mmH<sub>2</sub>O, Pa e inwg

**CMRH 2271**

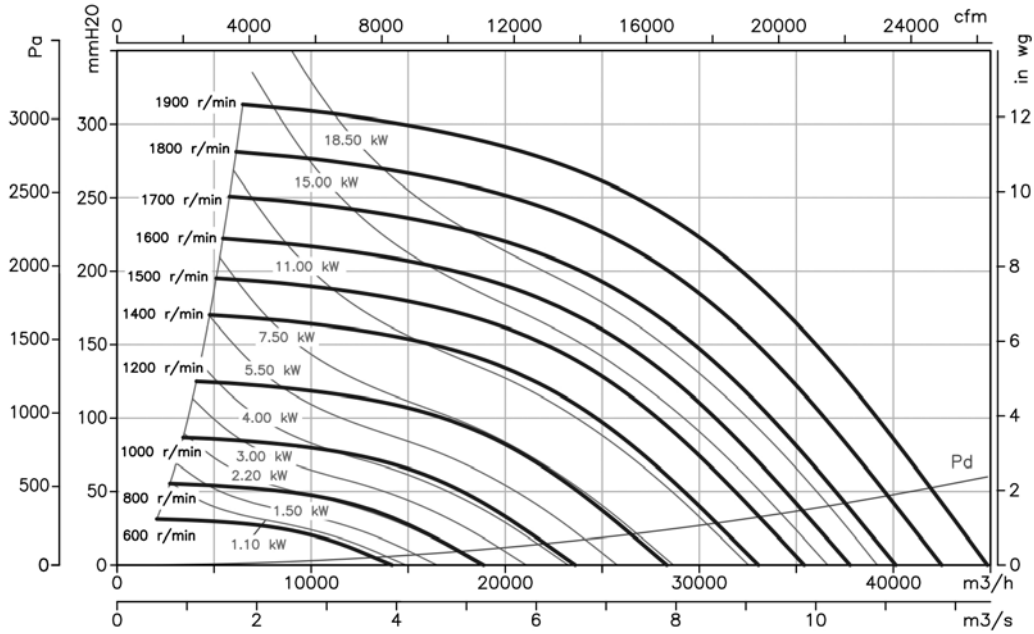

**CMRH 2380**

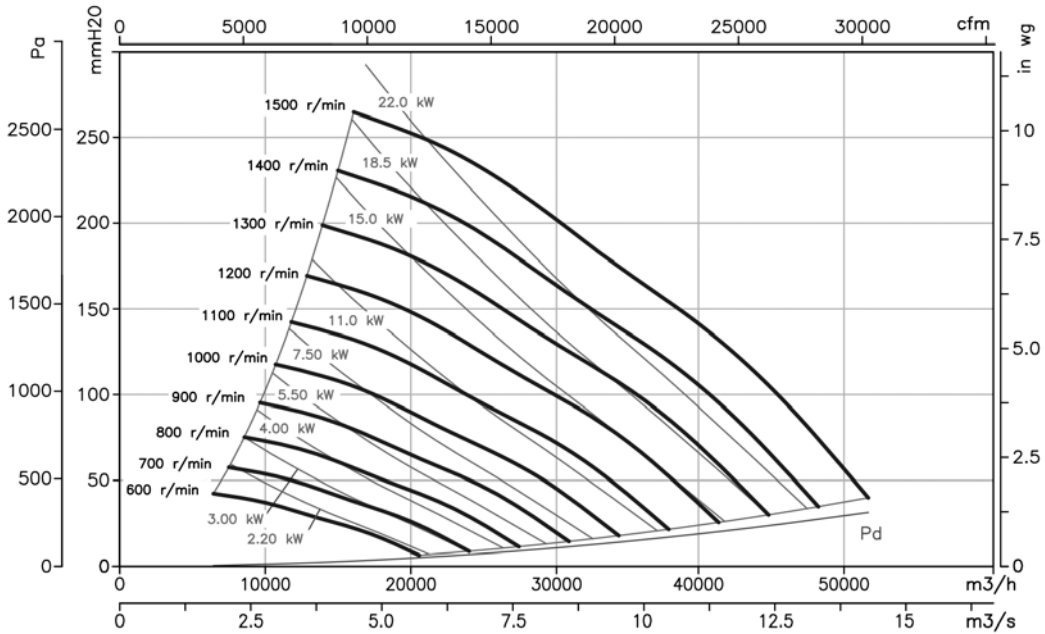



# HFW



## Ventiladores tubulares galvanizados en caliente

Ventiladores helicoidales tubulares diseñados con cuatro brazos soporte para reducir vibraciones y equipados con hélice de aluminio aerodinámica de bajo consumo.

### Ventilador:

- Dirección aire motor-hélice.
- Hélices versión AL en fundición de aluminio.
- Aro soporte en chapa de acero con doble brida y pasacables para alimentación del motor.
- Envoltente tubular en chapa de acero galvanizado en caliente.

### Motor:

- Motores de eficiencia IE2 para potencias iguales o superiores a 0,75kW e inferiores a 7,5kW, excepto monofásicos, 2 velocidades y 8 polos
- Motores de eficiencia IE3 para potencias iguales o superiores a 7,5kW, excepto monofásicos, 2 velocidades y 8 polos
- Motores clase F, con rodamientos a bolas, protección IP55.

- Trifásicos 230/400V-50Hz (hasta 4kW) y 400/690V-50Hz (potencias superiores a 4kW)
- Temperatura de trabajo : -25°C+ 50°C.

### Acabado:

- Galvanizado en caliente

### Bajo demanda:

- Dirección aire hélice-motor.
- Hélices versión PL en poliamida con fibra de vidrio.
- Hélices reversibles 100%.
- Bobinados especiales para diferentes tensiones.
- Certificación ATEX Categoría 2.
- Motores de eficiencias IE2 e IE3 para cualquier potencia

## Código de pedido

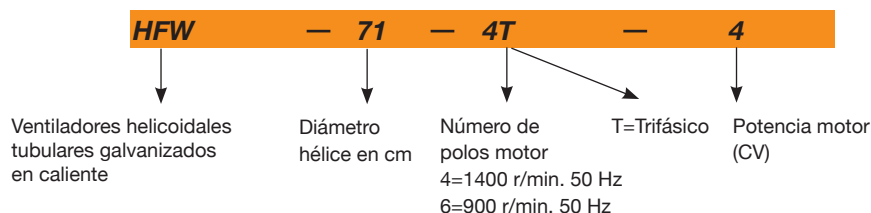

## Características técnicas

Modelo	Velocidad (r/min)	Intensidad máxima admisible (A)			Potencia instalada (kW)	Ángulo inclinación palas(°)	Caudal máximo (m³/h)	Nivel presión sonora dB(A)	Peso aprox. (Kg)
		230V	400V	690V					
HFW-56-4T-1	1410	3,10	1,79		0,75	22	11250	73	28
HFW-56-4T-1,5	1400	4,03	2,32		1,10	30	13600	74	32
HFW-56-4T-2	1430	5,96	3,44		1,50	36	15050	75	30
HFW-56-6T-0,75	910	2,59	1,49		0,55	38	10150	62	23
HFW-63-4T-1	1410	3,10	1,79		0,75	14	15200	73	29
HFW-63-4T-1,5	1400	4,03	2,32		1,10	20	17800	74	32
HFW-63-4T-2	1430	5,96	3,44		1,50	24	19300	75	35
HFW-63-4T-3	1445	8,36	4,83		2,20	32	22150	76	43
HFW-63-4T-4	1445	10,96	6,33		3,00	38	24250	77	45
HFW-63-6T-0,75	910	2,59	1,49		0,55	28	13600	65	29
HFW-63-6T-1	945	3,90	2,20		0,75	38	15900	66	35
HFW-71-4T-1,5	1400	4,03	2,32		1,10	12	19500	78	35
HFW-71-4T-2	1430	5,96	3,44		1,50	14	20900	79	38
HFW-71-4T-3	1445	8,36	4,83		2,20	22	25100	81	47
HFW-71-4T-4	1445	10,96	6,33		3,00	28	27500	82	49
HFW-71-6T-0,75	910	2,59	1,49		0,55	20	16100	67	31
HFW-71-6T-1	945	3,90	2,20		0,75	26	17300	68	38
HFW-71-6T-1,5	945	4,88	2,82		1,10	34	19950	69	40
HFW-80-4T-3	1445	8,36	4,83		2,20	12	25450	82	55
HFW-80-4T-4	1445	10,96	6,33		3,00	16	30250	83	57
HFW-80-4T-5,5	1440	14,10	8,12		4,00	18	32750	84	62
HFW-80-6T-1,5	945	4,88	2,82		1,10	18	21450	72	48
HFW-80-6T-2	955	6,42	3,71		1,50	26	25950	73	54
HFW-80-6T-3	955	9,30	5,30		2,20	32	29950	74	59
HFW-90-4T-4	1445	10,96	6,33		3,00	8	33600	87	66
HFW-90-4T-5,5	1440	14,10	8,12		4,00	12	38900	89	71
HFW-90-4T-7,5	1440		10,60	6,14	5,50	18	46150	91	87
HFW-90-4T-10 IE3	1465		8,06	13,90	7,50	22	50150	92	98
HFW-90-6T-2	955	6,42	3,71		1,50	16	28800	77	63
HFW-90-6T-3	955	9,30	5,30		2,20	24	34000	78	68
HFW-90-6T-4	960	12,70	7,30		3,00	30	38900	79	92
HFW-100-4T-7,5	1440		10,60	6,14	5,50	10	46850	92	95
HFW-100-4T-10 IE3	1465		8,06	13,90	7,50	16	57400	93	106
HFW-100-4T-15 IE3	1470		20,90	12,10	11,00	22	66300	94	129
HFW-100-4T-20 IE3	1470		28,30	16,40	15,00	28	76150	95	148
HFW-100-6T-3	955	9,30	5,30		2,20	16	37600	82	76
HFW-100-6T-4	960	12,70	7,30		3,00	20	41150	83	100
HFW-100-6T-5,5	960	16,50	9,46		4,00	26	47800	84	108



**Características acústicas**

Los valores indicados, se determinan mediante medidas de nivel de presión y potencia sonora en dB(A) obtenidas en campo libre a una distancia equivalente a dos veces la envergadura del ventilador más el diámetro de la hélice, con un mínimo de 1,5 mts.

Espectro de potencia sonora Lw(A) en dB(A) por banda de frecuencia en Hz

Modelo	63	125	250	500	1000	2000	4000	8000	Modelo	63	125	250	500	1000	2000	4000	8000
HFW-56-4T-1	48	68	76	81	83	80	73	62	HFW-80-4T-4	56	76	84	89	91	88	81	74
HFW-56-4T-1.5	49	69	77	82	84	81	74	63	HFW-80-4T-5.5	56	76	84	89	91	88	81	70
HFW-56-4T-2	50	70	78	83	85	82	75	64	HFW-80-6T-1.5	49	66	74	79	81	78	71	60
HFW-56-6T-0.75	37	57	65	70	72	69	62	51	HFW-80-6T-2	50	67	75	80	82	79	72	61
HFW-63-4T-1	50	70	78	83	85	82	75	64	HFW-80-6T-3	51	68	76	81	83	80	73	62
HFW-63-4T-1.5	48	68	76	81	83	80	73	65	HFW-90-4T-4	61	82	89	94	97	93	86	79
HFW-63-4T-2	52	68	76	81	83	80	73	66	HFW-90-4T-5.5	60	81	88	93	96	92	85	74
HFW-63-4T-3	53	70	78	83	85	82	77	67	HFW-90-4T-7.5	59	80	87	92	95	91	84	73
HFW-63-4T-4	54	71	79	84	86	83	78	68	HFW-90-4T-10	58	79	86	91	94	90	83	72
HFW-63-6T-0.75	42	60	68	73	75	72	65	56	HFW-90-6T-2	58	79	86	91	94	90	83	72
HFW-63-6T-1	43	62	70	75	77	74	67	57	HFW-90-6T-3	56	70	77	82	85	81	74	63
HFW-71-4T-1.5	54	74	82	87	89	86	79	69	HFW-90-6T-4	57	72	79	84	87	83	76	65
HFW-71-4T-2	53	73	81	86	88	85	78	70	HFW-100-4T-7.5	64	84	92	97	99	96	89	78
HFW-71-4T-3	58	72	80	85	87	84	77	71	HFW-100-4T-10	62	82	90	95	97	94	87	76
HFW-71-4T-4	59	73	81	86	88	85	78	72	HFW-100-4T-15	61	81	89	94	96	93	86	75
HFW-71-6T-0.75	44	63	72	74	76	73	66	55	HFW-100-4T-20	63	83	91	96	98	95	88	77
HFW-71-6T-1	45	65	73	75	77	74	67	56	HFW-100-6T-3	61	72	80	85	87	84	77	66
HFW-71-6T-1.5	46	66	71	76	78	75	68	57	HFW-100-6T-4	64	72	80	85	87	84	77	66
HFW-80-4T-3	57	77	85	90	92	89	82	73	HFW-100-6T-5.5	64	73	81	86	88	85	78	67



**Erp. Características del punto de máxima eficiencia (BEP)**

<b>PN</b>	Potencia nominal motor en kW	<b>ηe[%]</b>	Eficiencia
<b>MC</b>	Categoría de medición	<b>N</b>	Grado de eficiencia
<b>EC</b>	Categoría de eficiencia	<b>[kW]</b>	Potencia eléctrica
<b>S</b>	Estática	<b>[m³/h]</b>	Caudal
<b>T</b>	Total	<b>[mmH₂O]</b>	Presión estática o total (Según EC)
<b>VSD</b>	Variador de velocidad	<b>[RPM]</b>	Velocidad
<b>SR</b>	Relación específica		

Modelo	MC	EC	VSD	SR	ηe [%]	N	[kW]	[m3/h]	[mmH₂O]	[RPM]
HFW-56-4T-1	A	S	NO	1,00	37,2%	44,1	0,837	7959	14,38	1438
HFW-63-4T-1	C	S	NO	1,00	49,8%	56,5	0,868	9291	17,07	1436
HFW-63-4T-1.5	C	S	NO	1,00	47,9%	53,7	1,193	10625	19,76	1447
HFW-63-4T-2	C	S	NO	1,00	42,3%	47,4	1,551	12026	20,03	1449
HFW-63-4T-3	B	T	NO	1,00	61,9%	65,8	2,447	20324	27,38	1439
HFW-63-4T-4	B	T	NO	1,00	62,6%	65,9	3,020	24239	28,64	1440
HFW-63-6T-0.75	B	T	NO	1,00	57,7%	65,4	0,611	12174	10,64	949
HFW-63-6T-1	B	T	NO	1,00	57,1%	63,7	0,930	15880	12,29	942
HFW-71-4T-1.5	C	S	NO	1,00	47,9%	53,4	1,346	12330	19,20	1440
HFW-71-4T-2	C	S	NO	1,00	48,4%	53,6	1,495	13405	19,83	1450
HFW-71-4T-3	C	S	NO	1,00	42,8%	46,8	2,369	17056	21,84	1441
HFW-71-4T-4	C	S	NO	1,00	40,7%	44,0	2,976	19369	22,96	1441
HFW-71-6T-0.75	C	S	NO	1,00	40,3%	47,7	0,678	10743	9,35	944
HFW-71-6T-1	C	S	NO	1,00	38,4%	45,2	0,842	12404	9,58	947
HFW-71-6T-1.5	C	S	NO	1,00	34,0%	40,1	1,103	14226	9,69	955
HFW-80-4T-3	C	S	NO	1,00	47,0%	51,0	2,417	16923	24,69	1440
HFW-80-4T-4	C	S	NO	1,00	44,5%	47,4	3,404	20444	27,19	1432
HFW-80-4T-5.5	C	S	NO	1,00	43,6%	46,1	4,011	22304	28,78	1457
HFW-80-6T-1.5	C	S	NO	1,00	40,2%	45,9	1,224	14613	12,35	951
HFW-80-6T-2	C	S	NO	1,00	39,2%	44,0	1,764	17576	14,46	962
HFW-80-6T-3	C	S	NO	1,00	37,1%	41,1	2,317	20444	15,44	956
HFW-90-4T-4	C	S	NO	1,00	51,9%	55,2	3,028	19656	29,36	1440
HFW-90-4T-5.5	C	S	NO	1,00	50,5%	53,0	4,049	25081	29,94	1456
HFW-90-4T-7.5	C	S	NO	1,00	47,7%	49,0	6,251	31521	34,72	1465
HFW-90-4T-10 IE3	C	S	NO	1,01	46,1%	46,8	7,730	35009	37,36	1467
HFW-90-6T-2	C	S	NO	1,00	45,8%	50,8	1,625	19416	14,08	965
HFW-90-6T-3	C	S	NO	1,00	41,1%	44,8	2,615	23753	16,64	950
HFW-90-6T-4	C	S	NO	1,00	37,7%	40,6	3,515	27183	17,92	970
HFW-100-4T-7.5	C	S	NO	1,00	52,1%	53,9	5,240	30466	32,94	1471
HFW-100-4T-10 IE3	C	S	NO	1,00	48,9%	49,4	8,112	37591	38,73	1466
HFW-100-4T-15 IE3	C	S	NO	1,01	44,7%	44,3	11,841	44571	43,65	1470
HFW-100-4T-20 IE3	C	S	NO	1,01	41,3%	40,1	15,684	50259	47,37	1471
HFW-100-6T-3	C	S	NO	1,00	45,0%	48,9	2,474	24629	16,62	953
HFW-100-6T-4	C	S	NO	1,00	43,9%	47,1	3,131	27632	18,28	974
HFW-100-6T-5.5	C	S	NO	1,00	38,9%	41,2	4,429	32373	19,56	971

Dimensiones mm

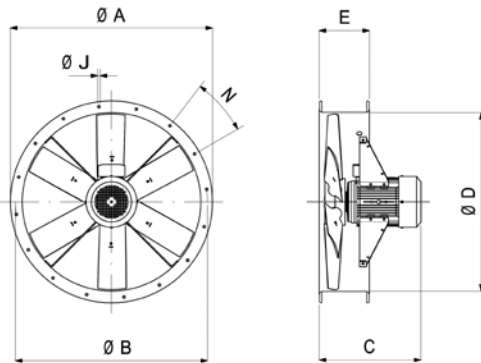

Modelo	ØA	ØB	C										ØD	E	ØJ	N		
			0,75	1	1,5	2	3	4	5,5	7,5	10	15					20	
HFW-56-4	665	620	-	330	380	380	-	-	-	-	-	-	-	-	560	225	12	12x30°
HFW-56-6	665	620	330	-	-	-	-	-	-	-	-	-	-	-	560	225	12	12x30°
HFW-63-4	735	690	-	379	429	429	470	470	-	-	-	-	-	640	225	12	12x30°	
HFW-63-6	735	690	379	429	-	-	-	-	-	-	-	-	-	640	225	12	12x30°	
HFW-71-4	815	770	-	-	389	389	430	430	-	-	-	-	-	710	225	12	16x22°30'	
HFW-71-6	815	770	339	389	389	-	-	-	-	-	-	-	-	710	225	12	16x22°30'	
HFW-80-4	905	860	-	-	-	-	436	436	460	-	-	-	-	800	225	12	16x22°30'	
HFW-80-6	905	860	-	-	395	436	460	-	-	-	-	-	-	800	225	12	16x22°30'	
HFW-90-4	1018	970	-	-	-	-	401	425	485	525	-	-	-	900	225	15	16x22°30'	
HFW-90-6	1018	970	-	-	-	401	425	485	-	-	-	-	-	900	225	15	16x22°30'	
HFW-100-4	1118	1070	-	-	-	-	-	-	488	528	643	703	1000	225	15	16x22°30'		
HFW-100-6	1118	1070	-	-	-	-	428	488	528	-	-	-	-	1000	225	15	16x22°30'	

Curvas características

Q= Caudal en m³/h, m³/s y cfm.

Pe= Presión estática en mmH²O, Pa e inwg.

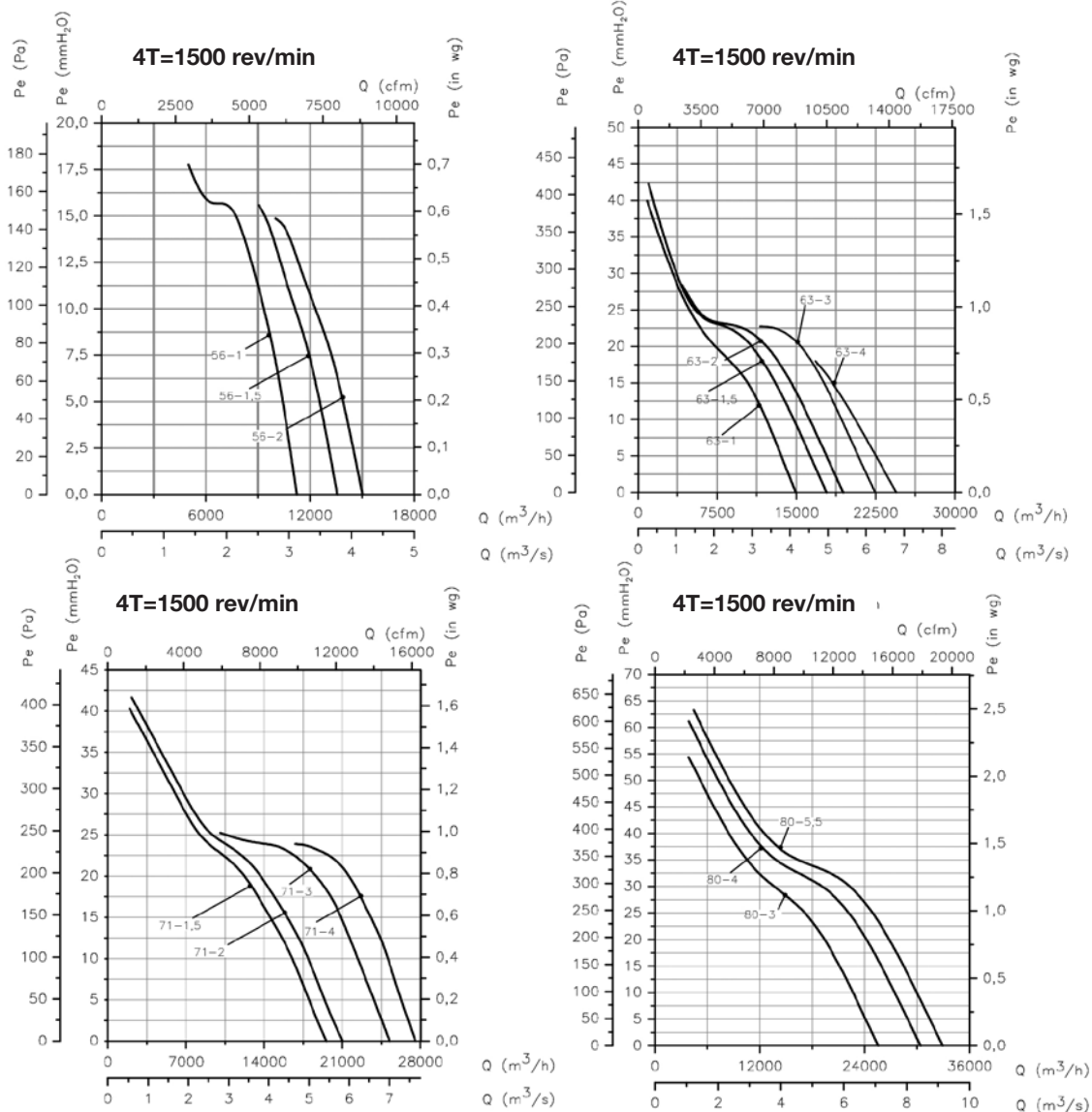

**Curvas características**

Q= Caudal en m<sup>3</sup>/h, m<sup>3</sup>/s y cfm.

Pe= Presión estática en mmH<sub>2</sub>O, Pa e inwg.

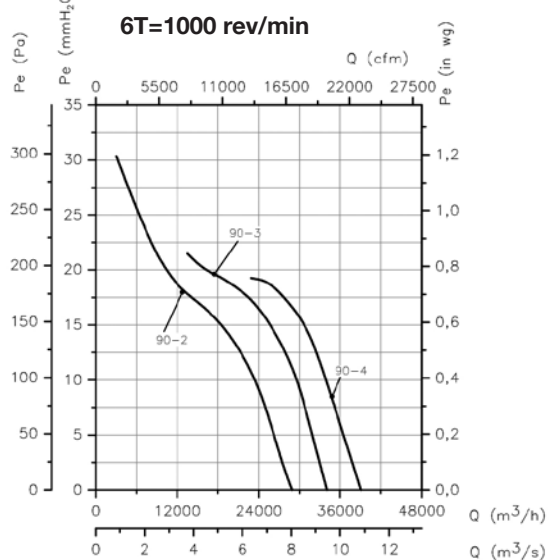
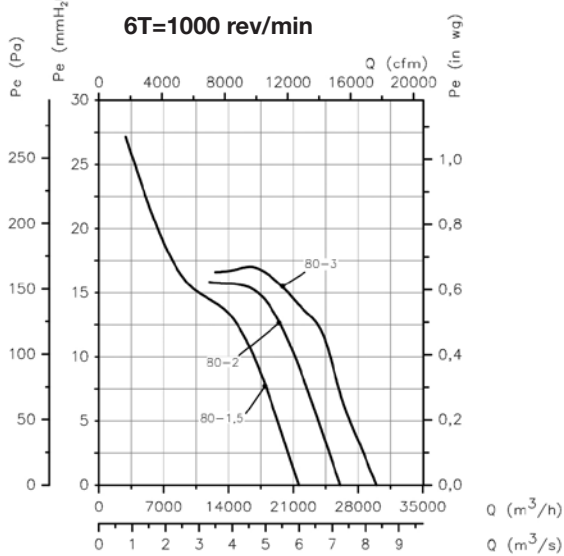
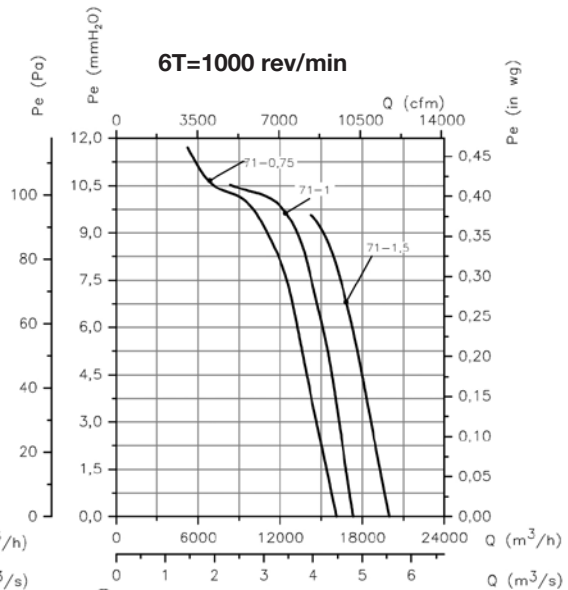
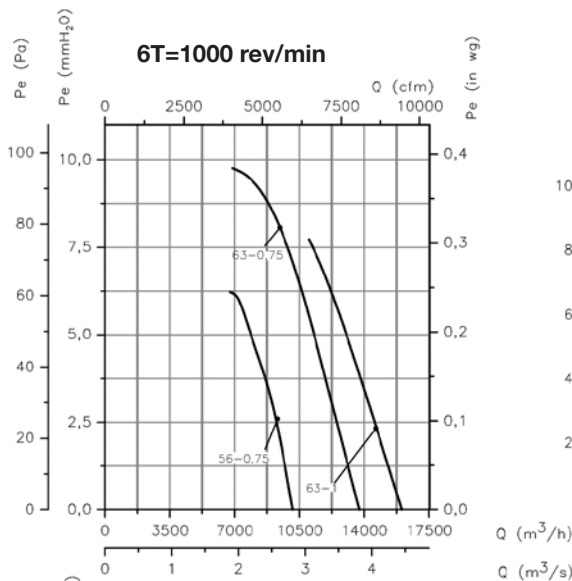
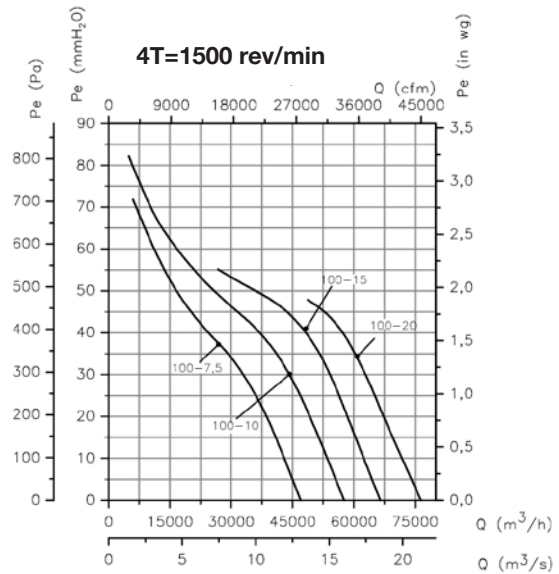
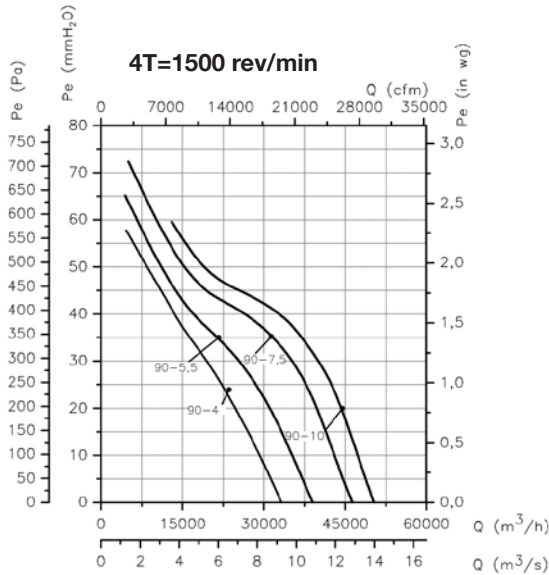

**Curvas características**

Q= Caudal en m<sup>3</sup>/h, m<sup>3</sup>/s y cfm. Pe= Presión estática en mmH<sup>2</sup>O, Pa e inwg.

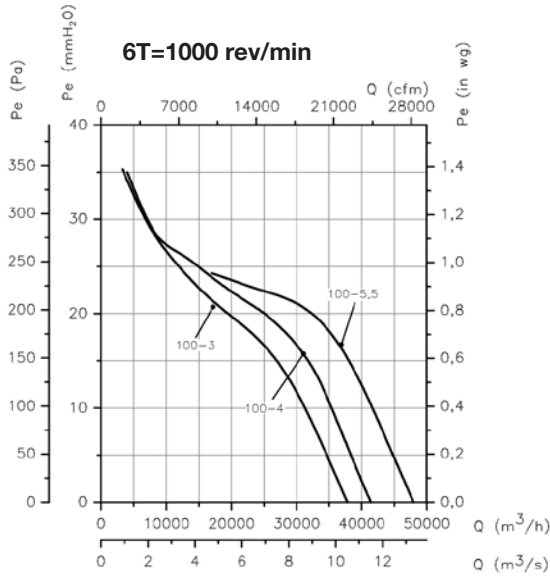

**Accesorios**

Ver apartado accesorios.



# HTP



Hélice de alta presión

## Extractores axiales tubulares de alta presión

Extractores axiales tubulares de alta presión y gran robustez, especialmente diseñados para instalaciones de minería o aplicaciones con grandes pérdidas de carga



### Ventilador:

- Envolverte tubular en chapa de acero de gran espesor
- Soporte de motor soldado al envolverte.
- Directrices de alto rendimiento aerodinámico para ganancia de presión
- Óptima protección superficial mediante acero de alta calidad.
- Hélice de alto rendimiento, construida en fundición de aluminio
- Sentido de aire hélice-motor
- Conexión eléctrica en caja de bornes externa.

### Motor:

- Motores de eficiencia IE2 para potencias iguales o superiores a 0,75kW e inferiores a 7,5kW, excepto monofásicos, 2 velocidades y 8 polos
- Motores de eficiencia IE3 para potencias iguales o superiores a 7,5kW, excepto monofásicos, 2 velocidades y 8 polos
- Motores clase F, con rodamientos a bolas, protección IP-55
- Trifásicos 230/400V-50Hz (hasta 4 kW) y 400/690V-50Hz (potencias superiores a 4 kW)
- Temperatura de trabajo -20°C + 70°C

### Acabado:

- Acero de alta protección anticorrosivo, imprimación especial y pintura de alta calidad para ambientes corrosivos.

### Bajo demanda:

- Motores normalizados IP-55, motores ATEX y de 2 Velocidades
- Construcción total en acero inoxidable
- Construcción en acero galvanizado en caliente
- Certificación ATEX Categoría 2
- Motores de eficiencias IE2 e IE3 para cualquier potencia



## Código de pedido

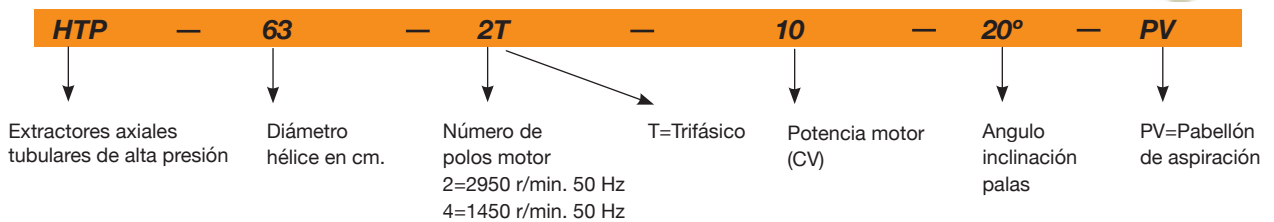

## Características técnicas

Modelo	Velocidad (r/min)	Intensidad máxima admisible (A)			Potencia instalada (kW)	Caudal máximo (m³/h)	Peso aprox. (Kg)	NPS dB(A)
		230V	400V	690V				
HTP-50-2T-4	2900	10,18	5,88	-	3,00	13850	49	82
HTP-50-2T-5,5	2870	13,60	7,82	-	4,00	16450	65	83
HTP-56-2T-5,5	2870	13,60	7,82	-	4,00	18050	69	88
HTP-56-2T-10 IE3	2930		14,10	8,17	7,50	25500	143	89
HTP-63-2T-10 IE3	2930		14,10	8,17	7,50	23850	128	94
HTP-63-2T-15 IE3	2945		20,00	11,60	11,00	29400	199	94
HTP-63-2T-20 IE3	2945		27,70	16,10	15,00	34400	205	97
HTP-63-2T-25 IE3	2945		33,90	19,70	18,50	37200	216	98
HTP-63-2T-30 IE3	2950		39,70	23,00	22,00	39800	208	99
HTP-63-4T-1,5	1400	4,03	2,32	-	1,10	12850	92	79
HTP-63-4T-2	1430	5,96	3,44	-	1,50	15650	93	79
HTP-63-4T-3	1445	8,36	4,83	-	2,20	18600	101	83
HTP-63-4T-4	1445	10,96	6,33	-	3,00	19900	104	84
HTP-71-2T-15 IE3	2945		20,00	11,60	11,00	32850	216	93
HTP-71-2T-20 IE3	2945		27,70	16,10	15,00	39250	222	95
HTP-71-2T-25 IE3	2945		33,90	19,70	18,50	43450	233	95
HTP-71-2T-30 IE3	2950		39,70	23,00	22,00	45500	225	95
HTP-71-2T-40 IE3	2960		54,50	31,60	30,00	52550	333	98
HTP-71-4T-2	1445	8,36	4,83	-	2,20	17500	110	83
HTP-71-4T-3	1445	8,36	4,83	-	2,20	20650	118	83
HTP-71-4T-4	1445	10,96	6,33	-	3,00	23950	121	84
HTP-71-4T-5,5	1440	14,10	8,12	-	4,00	27400	127	87

**Características técnicas**

Modelo	Velocidad (r/min)	Intensidad máxima admisible (A)			Potencia instalada (kW)	Caudal máximo (m³/h)	Peso aprox. (Kg)	NPS dB(A)
		230V	400V	690V				
HTP-71-4T-7,5	1440	-	11,60	6,72	5,50	31700	141	90
HTP-80-4T-4	1445	10,96	6,33	-	3,00	19300	146	86
HTP-80-4T-5,5	1440	14,10	8,12	-	4,00	22850	152	86
HTP-80-4T-7,5	1440	-	11,60	6,72	5,50	28000	166	86
HTP-80-4T-10 IE3	1465	-	13,90	8,06	7,50	31500	193	87
HTP-80-4T-15 IE3	1470	-	20,90	12,10	11,00	40000	242	91
HTP-90-4T-7,5	1440	-	11,60	6,72	5,50	27450	196	90
HTP-90-4T-10 IE3	1465	-	13,90	8,06	7,50	32500	223	90
HTP-90-4T-15 IE3	1470	-	20,90	12,10	11,00	42200	272	90
HTP-90-4T-20 IE3	1465	-	27,90	16,20	15,00	50050	283	94
HTP-90-4T-25 IE3	1470	-	35,10	20,30	18,50	54550	326	95
HTP-90-4T-30 IE3	1470	-	41,00	23,80	22,00	61750	326	97
HTP-100-4T-15 IE3	1470	-	20,90	12,10	11,00	46100	307	93
HTP-100-4T-20 IE3	1465	-	27,90	16,20	15,00	56300	318	93
HTP-100-4T-25 IE3	1470	-	35,10	20,30	18,50	59900	361	93
HTP-100-4T-30 IE3	1470	-	41,00	23,80	22,00	69900	361	96
HTP-100-4T-40 IE3	1480	-	57,10	33,10	30,00	80500	429	98
HTP-125-4T-40 IE3	1480	-	57,10	33,10	30,00	81000	531	100
HTP-125-4T-50 IE3	1480	-	69,20	40,10	37,00	96800	602	100
HTP-125-4T-60 IE3	1475	-	80,90	46,90	45,00	105050	658	100
HTP-125-4T-75 IE3	1480	-	98,60	57,20	55,00	127800	664	100
HTP-125-4T-100 IE3	1485	-	134,00	77,70	75,00	147350	784	104
HTP-125-4T-125 IE3	1485	-	158,00	91,60	90,00	156800	823	105

**Características acústicas**

Los valores indicados, se determinan mediante medidas de nivel de presión y potencia en dB(A), obtenidas en campo libre a una distancia equivalente a dos veces la envergadura del ventilador más el diámetro de la hélice, con un mínimo de 1,5 m

Espectro de potencia sonora Lw(A) en dB(A) por banda de frecuencia en Hz

Modelo	Lp dB (A)	63	125	250	500	1000	2000	4000	8000	Modelo	Lp dB (A)	63	125	250	500	1000	2000	4000	8000
HTP-50-2T-4	80	57	77	85	90	92	89	82	71	HTP-80-4T-4	86	58	75	86	95	96	96	93	86
HTP-50-2T-5,5	81	58	78	86	91	93	90	83	72	HTP-80-4T-5,5	86	58	76	86	95	96	96	93	86
HTP-56-2T-5,5	86	63	83	91	96	98	95	88	77	HTP-80-4T-7,5	86	58	76	86	95	96	96	93	86
HTP-56-2T-10	87	64	84	92	97	99	96	89	78	HTP-80-4T-10	87	59	77	87	97	98	98	94	88
HTP-63-2T-10	94	70	82	92	104	105	104	99	91	HTP-80-4T-15	91	63	81	91	101	102	102	99	92
HTP-63-2T-15	94	70	82	92	104	105	104	99	91	HTP-90-4T-7,5	90	62	79	90	99	100	100	97	90
HTP-63-2T-20	97	73	85	95	107	108	107	102	94	HTP-90-4T-10	90	62	80	90	99	100	100	97	90
HTP-63-2T-25	98	74	86	96	108	109	108	103	95	HTP-90-4T-15	90	62	80	90	100	101	101	98	91
HTP-63-2T-30	99	75	87	97	109	110	109	104	96	HTP-90-4T-20	94	66	83	94	103	104	104	101	94
HTP-63-4T-1,5	79	55	67	77	89	90	89	84	76	HTP-90-4T-25	95	67	85	95	104	105	105	102	95
HTP-63-4T-2	79	55	67	77	89	90	89	84	76	HTP-90-4T-30	97	69	87	97	107	108	108	104	98
HTP-63-4T-3	83	59	71	81	93	94	93	88	80	HTP-100-4T-15	93	65	83	93	102	103	103	100	93
HTP-63-4T-4	84	60	72	82	94	95	94	89	81	HTP-100-4T-20	93	65	82	93	102	103	103	100	93
HTP-71-2T-15	93	65	83	93	102	104	103	100	93	HTP-100-4T-25	93	65	83	93	102	103	103	100	93
HTP-71-2T-20	95	67	85	95	104	106	105	102	95	HTP-100-4T-30	96	67	85	96	105	106	106	103	96
HTP-71-2T-25	95	67	85	95	104	106	105	102	95	HTP-100-4T-40	98	70	88	98	107	108	108	105	98
HTP-71-2T-30	95	67	85	95	104	106	105	102	95	HTP-125-4T-40	100	72	89	100	109	110	110	107	100
HTP-71-2T-40	98	70	88	98	107	109	108	105	98	HTP-125-4T-50	100	72	90	100	109	110	110	107	100
HTP-71-4T-2	83	55	73	83	92	93	93	90	83	HTP-125-4T-60	100	72	89	100	109	110	110	107	100
HTP-71-4T-3	83	55	72	83	92	93	93	90	83	HTP-125-4T-75	100	72	90	100	110	111	111	108	101
HTP-71-4T-4	84	56	74	84	94	95	95	91	85	HTP-125-4T-100	104	76	93	104	113	114	114	111	104
HTP-71-4T-5,5	87	59	77	87	97	98	98	95	88	HTP-125-4T-125	105	77	95	105	114	115	115	112	105
HTP-71-4T-7,5	90	62	80	90	100	101	101	97	91										

**Dimensiones mm**

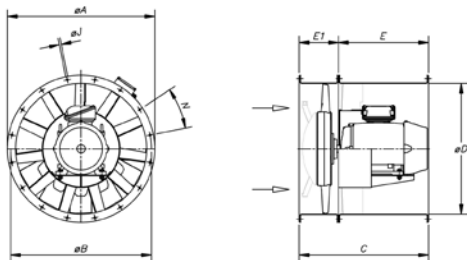

Modelo	Potencia	ØA	ØB	ØD	E	E1	C	ØJ	N
HTP-50-2T	4/5/5	600	560	514	-	-	400	12	12x30°
HTP-56-2T	5/5/10	660	620	560	-	-	500	12	12x30°
HTP-63-2T	10/15/20/25/30	730	690	640	650	220	870	13	12x30°
HTP-63-4T	1/5/2/3/4	730	690	640	340	220	560	13	12x30°
HTP-71-2T	15/20/25/30/40	810	770	710	700	240	940	13	16x22°30'
HTP-71-4T	2/3/4/5/5/7/5	810	770	710	420	240	660	13	16x22°30'
HTP-80-4T	4 / 5/5	900	860	800	360	240	600	15	16x22°30'
HTP-80-4T	7/5 / 10 / 15	900	860	800	600	240	840	15	16x22°30'
HTP-90-4T	7/5 / 10	1015	970	900	420	250	670	15	16x22°30'
HTP-90-4T	15 / 20 / 25 / 30	1015	970	900	650	250	900	15	16x22°30'
HTP-100-4T	15 / 20	1115	1070	1000	600	270	870	15	16x22°30'
HTP-100-4T	25 / 30 / 40	1115	1070	1000	700	270	970	15	16x22°30'
HTP-125	40 / 50 / 60 / 75	1365	1320	1250	900	300	1100	15	20x18°
HTP-125	100 / 125	1365	1320	1250	950	300	1250	15	20x18°

## EJEMPLO SELECCIÓN

### Curvas características

Q= Caudal en m³/h, m³/s y cfm.

Pe= Presión estática en mmH<sub>2</sub>O., Pa e inwg.

#### HTP-63-4T

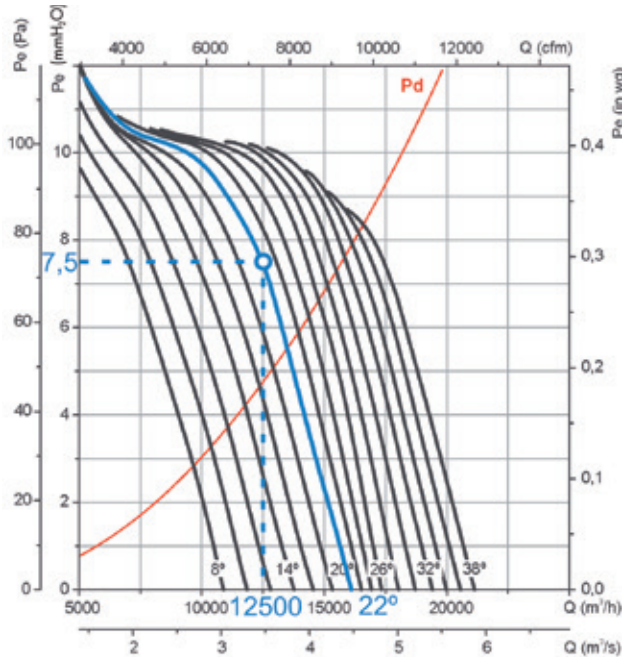

#### Datos de partida

- Punto de trabajo:
- Caudal: 12.500 m³/h
- Pérdida de carga: 7,5 mmH<sub>2</sub>O

#### Pasos para la selección del equipo

##### En la gráfica de presiones:

1. Marcar el punto de trabajo, definido por el caudal de trabajo (12.500 m³/h) y la pérdida de carga (7,5 mmH<sub>2</sub>O).
2. Escoger la curva del equipo que más se acerque por encima al punto de trabajo. En nuestro caso se obtiene una curva de 22° de ángulo de pala.

##### En la gráfica de potencia:

3. Marcar el punto de trabajo, definido por el caudal de trabajo (12.500 m³/h) y la curva de ángulo de pala escogido (22°).
4. Leer la potencia absorbida en el eje de potencias a la izquierda. La Pa= 560 W en el punto de trabajo.
5. Buscar recta roja que más se acerque al punto de trabajo por encima. En la parte derecha de la gráfica se obtiene el valor de potencia instalada de motor. En nuestro caso 0,75 kW o 1 CV

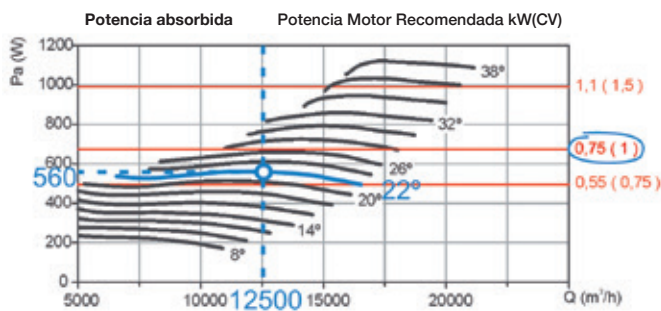

## EJEMPLO CÓDIGO PEDIDO

<b>HTP</b>	—	<b>63</b>	—	<b>4T</b>	—	<b>1</b>	—	<b>22°</b>
↓		↓		↓		↓		↓
Extractores axiales tubulares de alta presión		Diámetro hélice en cm		Número de polos motor 4=1400 r/min. 50 Hz 6=900 r/min. 50 Hz 8=750 r/min. 50 Hz		T=Trifásico M=Monofásico		Potencia motor (CV)
								Angulo inclinación palas

**Curvas características**

Q= Caudal en m<sup>3</sup>/h, m<sup>3</sup>/s y cfm.

Pe= Presión estática en mmH<sub>2</sub>O, Pa e inwg.

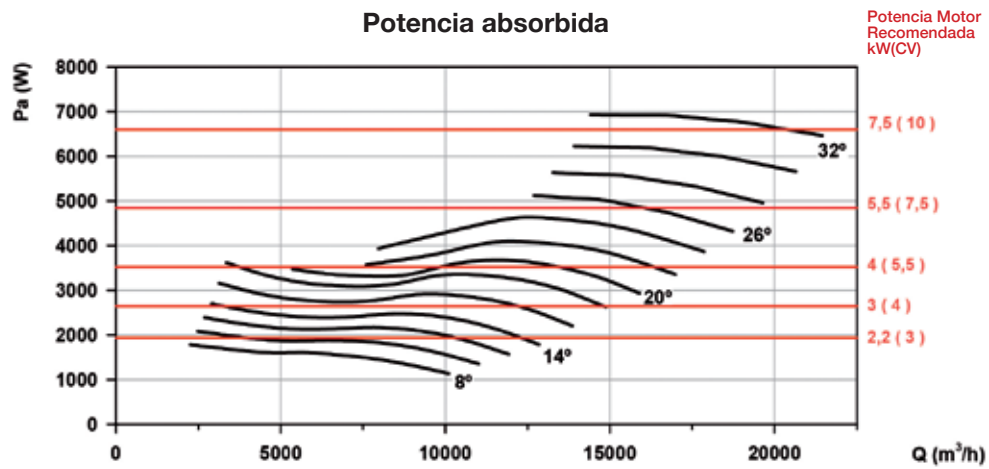
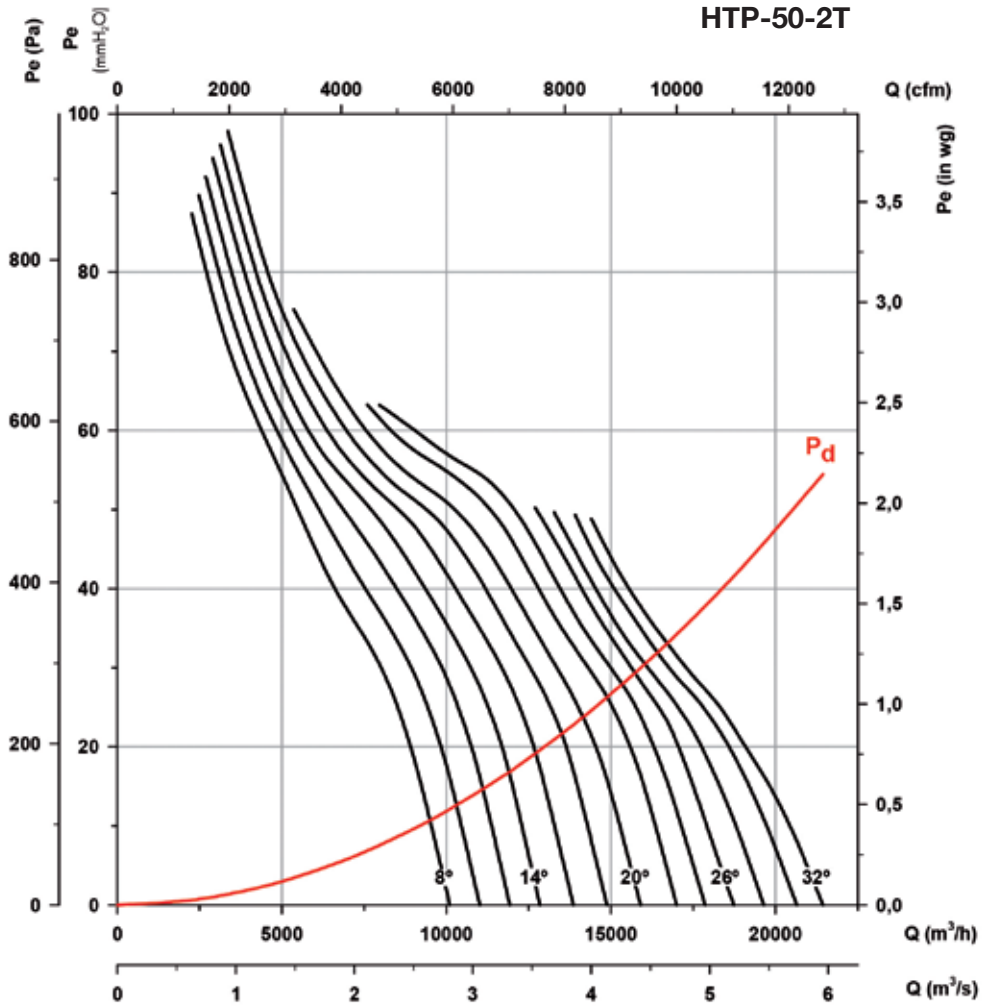

Consultar características del punto de máxima eficiencia (BEP) al final de la serie.



**Curvas características**

Q= Caudal en m<sup>3</sup>/h, m<sup>3</sup>/s y cfm.

Pe= Presión estática en mmH<sub>2</sub>O, Pa e inwg.

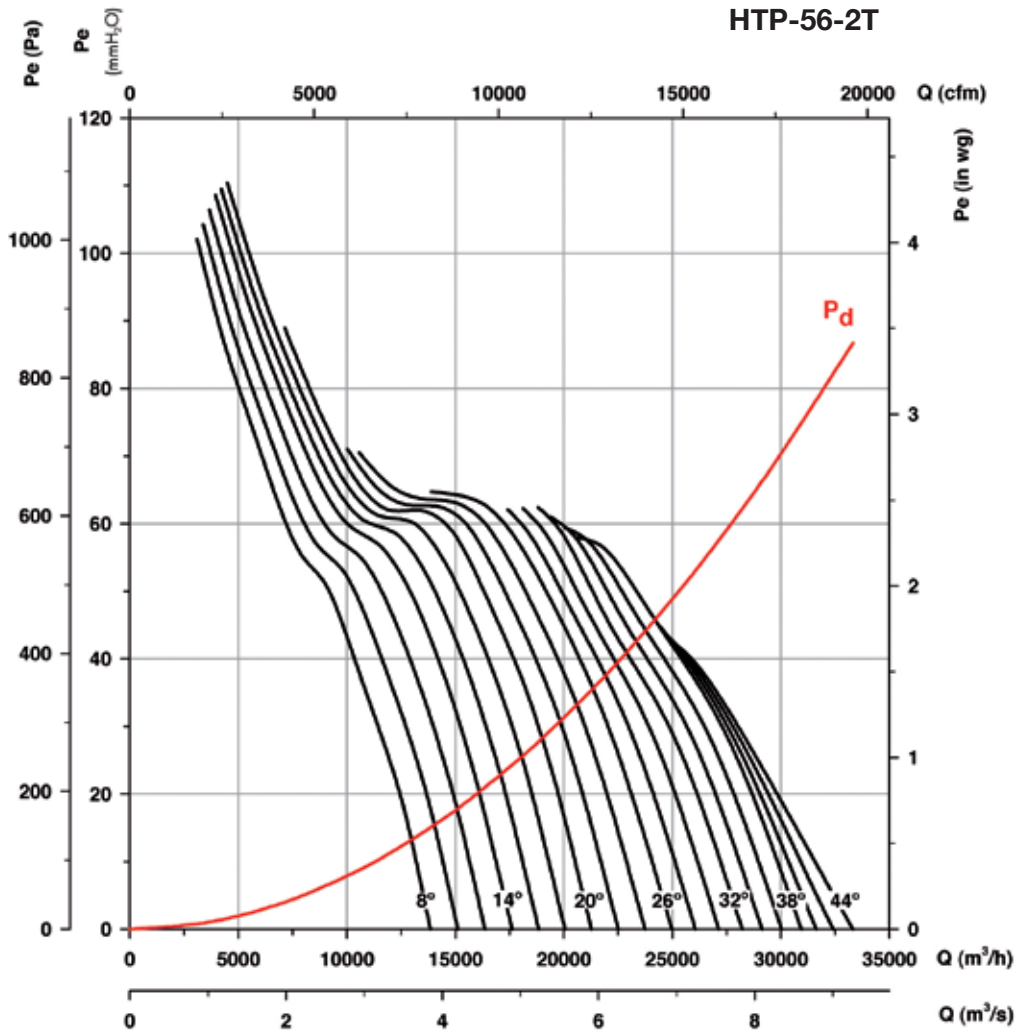

Potencia absorbida

Potencia Motor Recomendada kW(CV)

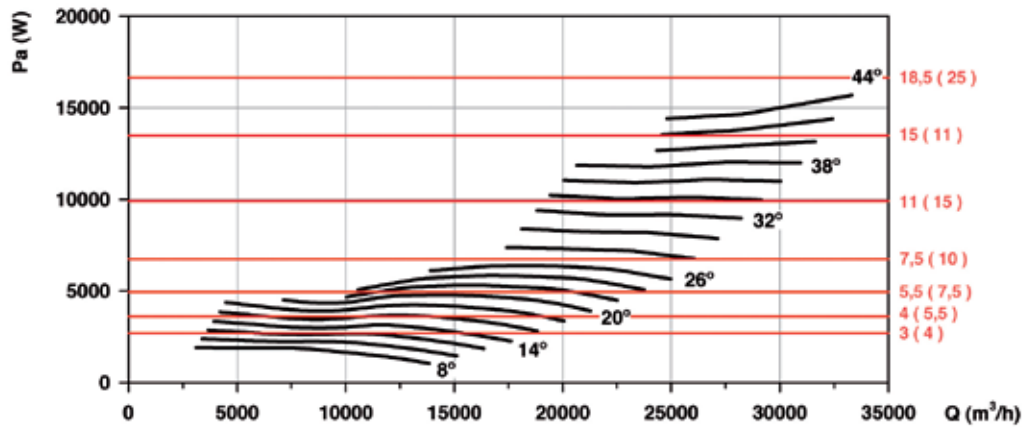

Consultar características del punto de máxima eficiencia (BEP) al final de la serie.

**Curvas características**

Q= Caudal en m<sup>3</sup>/h, m<sup>3</sup>/s y cfm.

Pe= Presión estática en mmH<sub>2</sub>O, Pa e inwg.

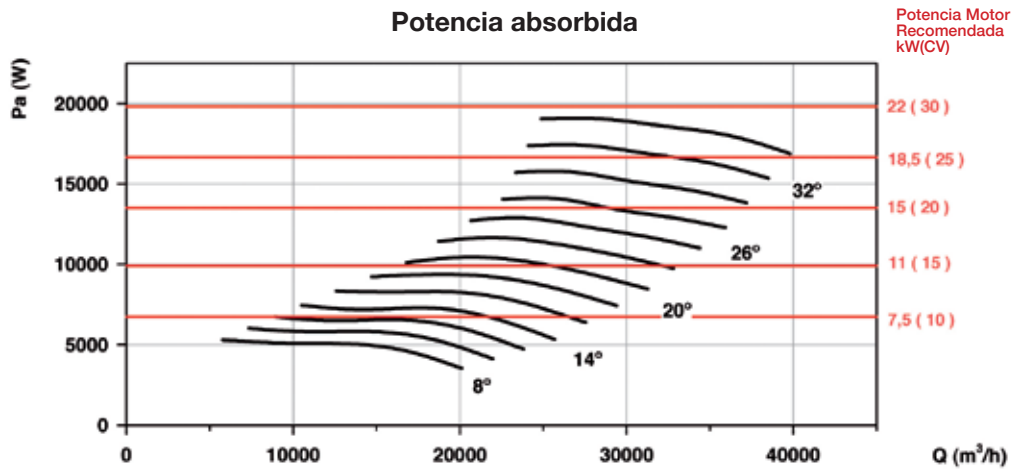
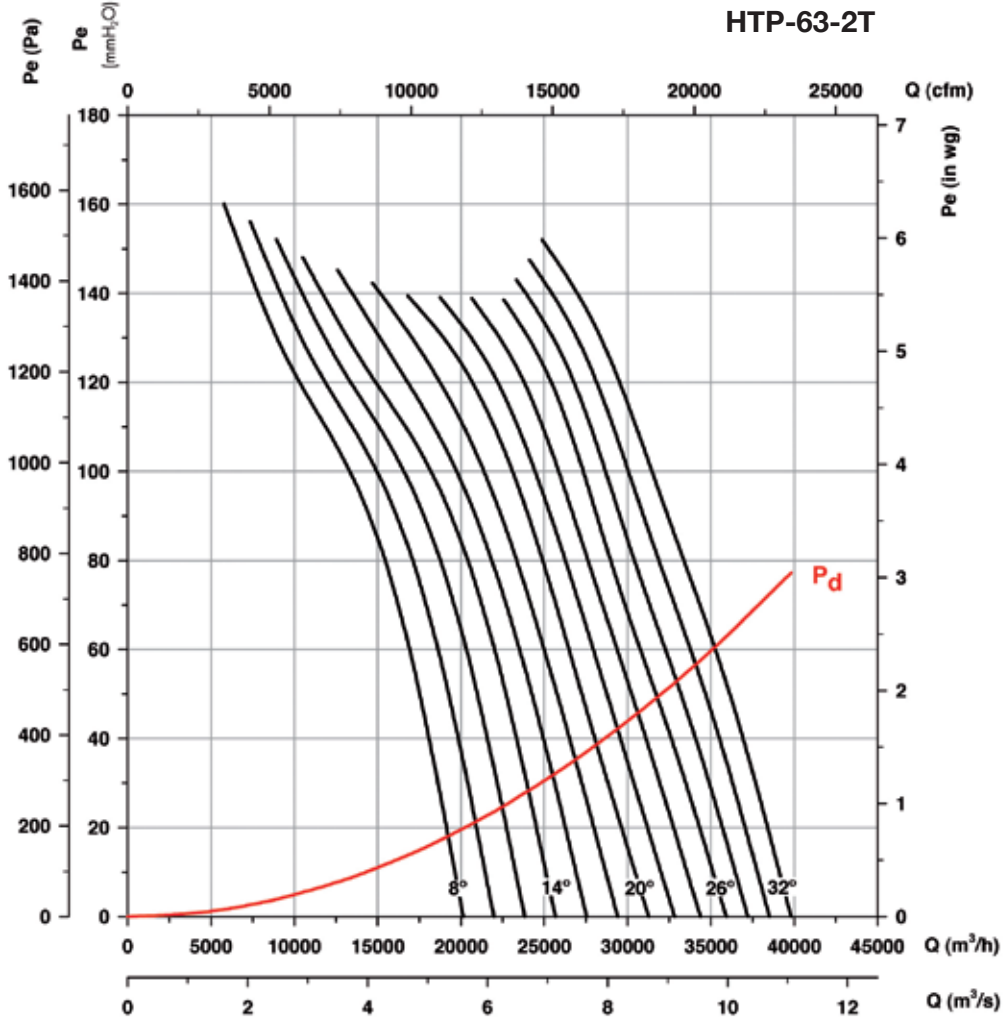

Consultar características del punto de máxima eficiencia (BEP) al final de la serie.

**Curvas características**

Q= Caudal en m<sup>3</sup>/h, m<sup>3</sup>/s y cfm.

Pe= Presión estática en mmH<sub>2</sub>O, Pa e inwg.

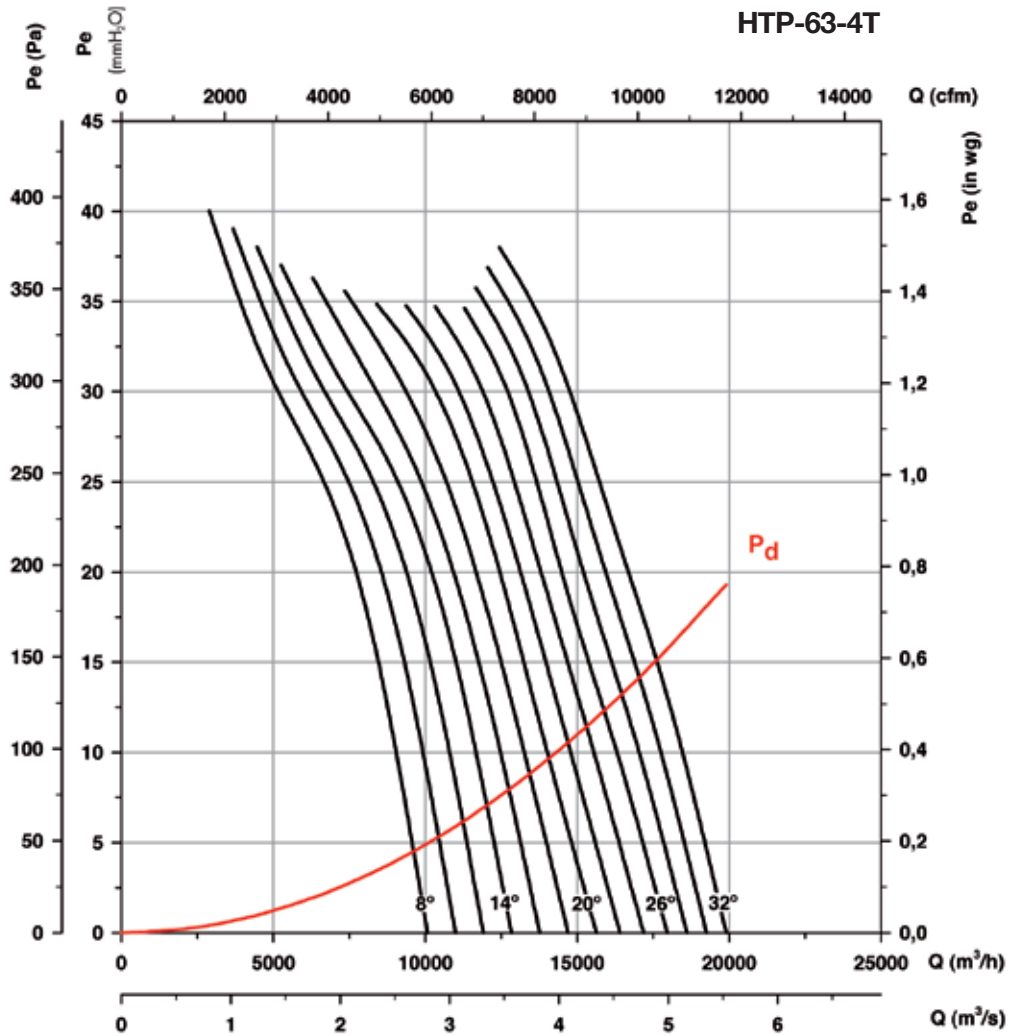

**Potencia absorbida**

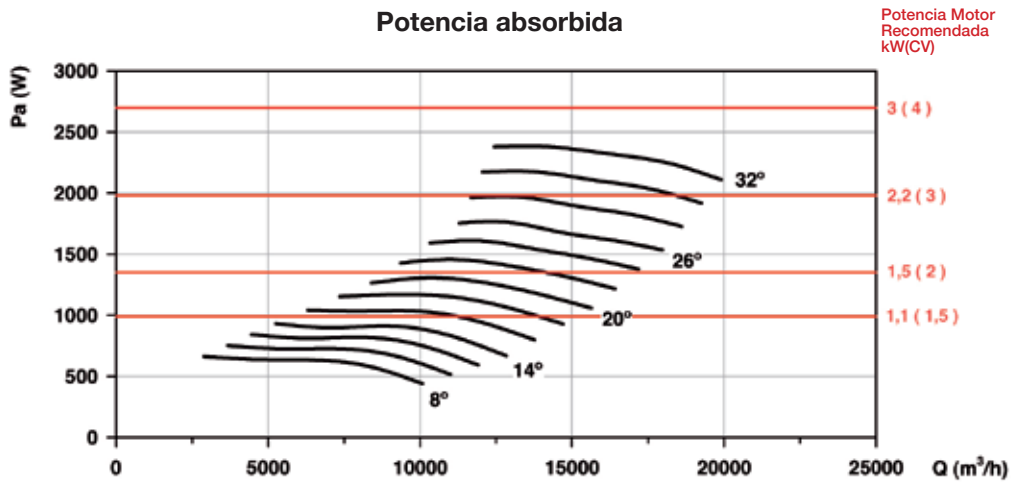

Consultar características del punto de máxima eficiencia (BEP) al final de la serie.

**Curvas características**

Q= Caudal en m<sup>3</sup>/h, m<sup>3</sup>/s y cfm.

Pe= Presión estática en mmH<sub>2</sub>O, Pa e inwg.

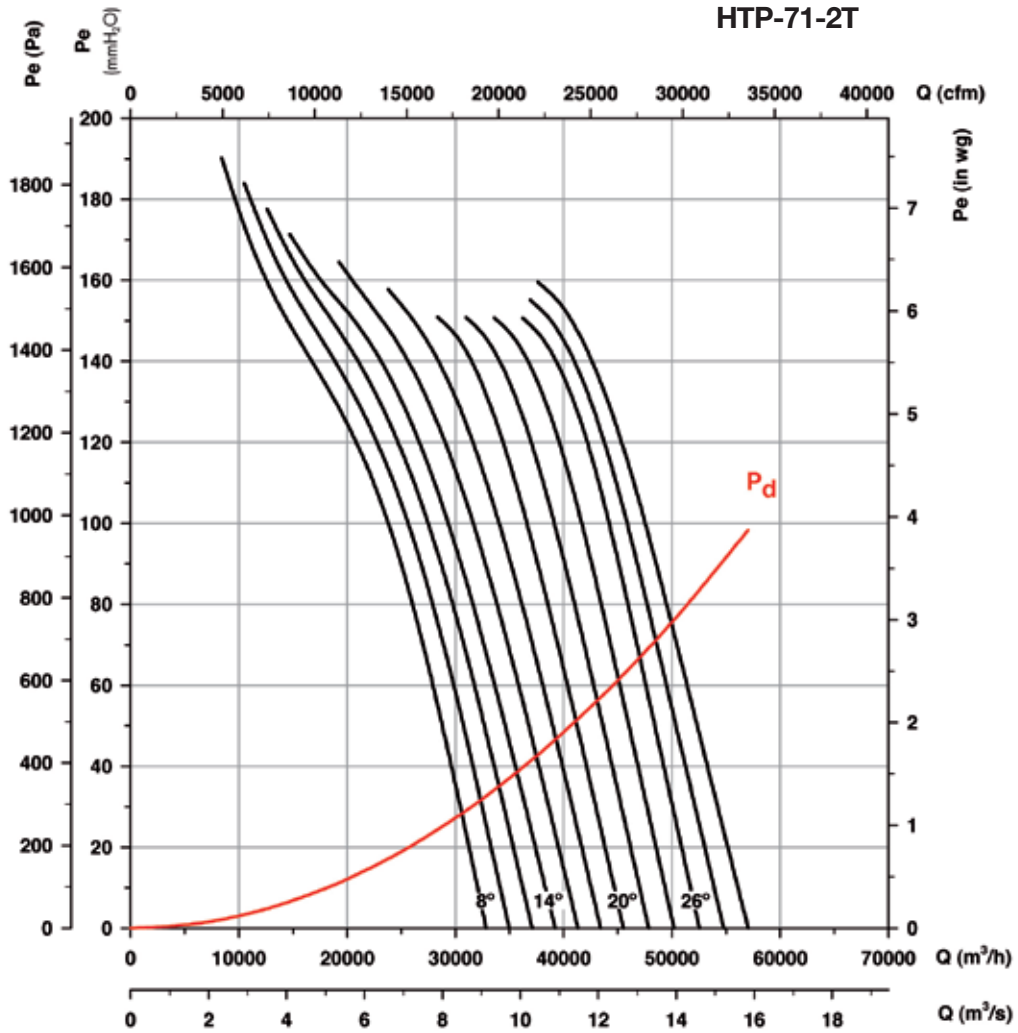

**Potencia absorbida**

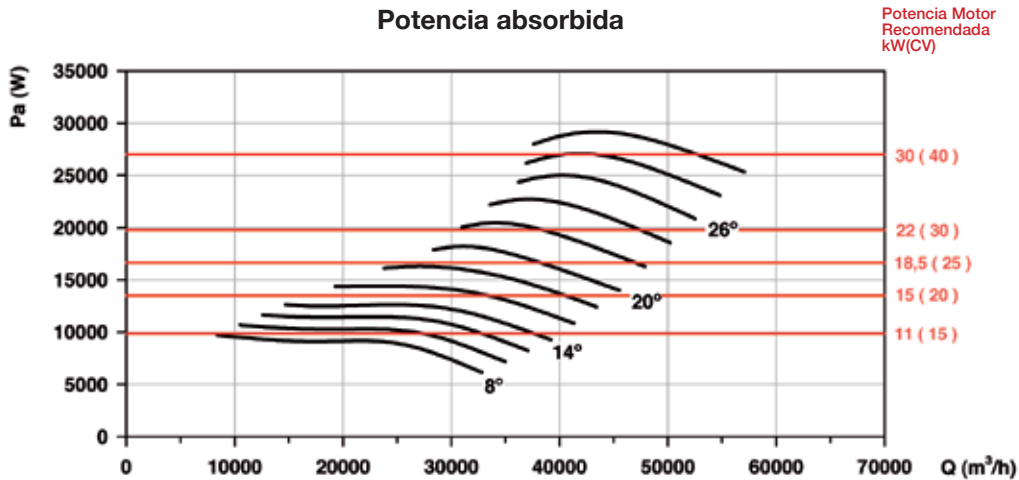

Consultar características del punto de máxima eficiencia (BEP) al final de la serie.

**Curvas características**

Q= Caudal en m<sup>3</sup>/h, m<sup>3</sup>/s y cfm.

Pe= Presión estática en mmH<sub>2</sub>O, Pa e inwg.

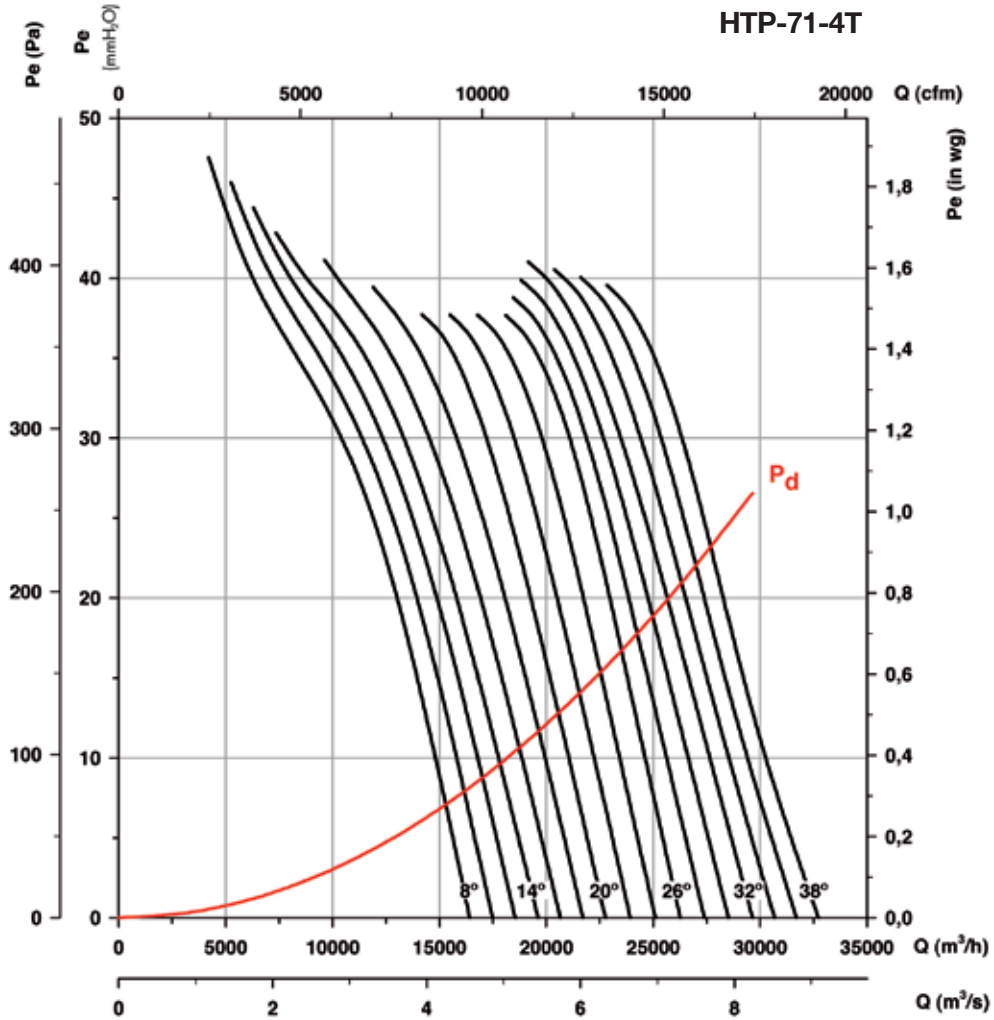

**Potencia absorbida**

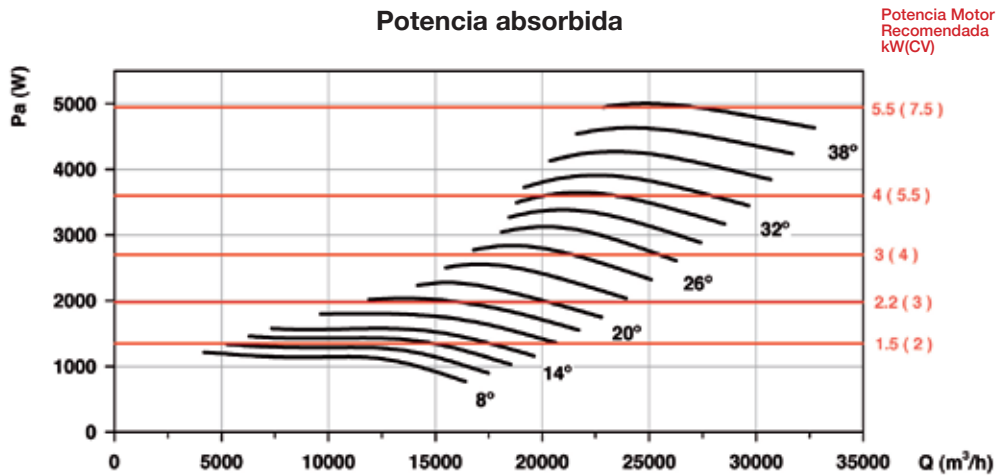

Consultar características del punto de máxima eficiencia (BEP) al final de la serie.

**Curvas características**

Q= Caudal en m<sup>3</sup>/h, m<sup>3</sup>/s y cfm.

Pe= Presión estática en mmH<sub>2</sub>O, Pa e inwg.

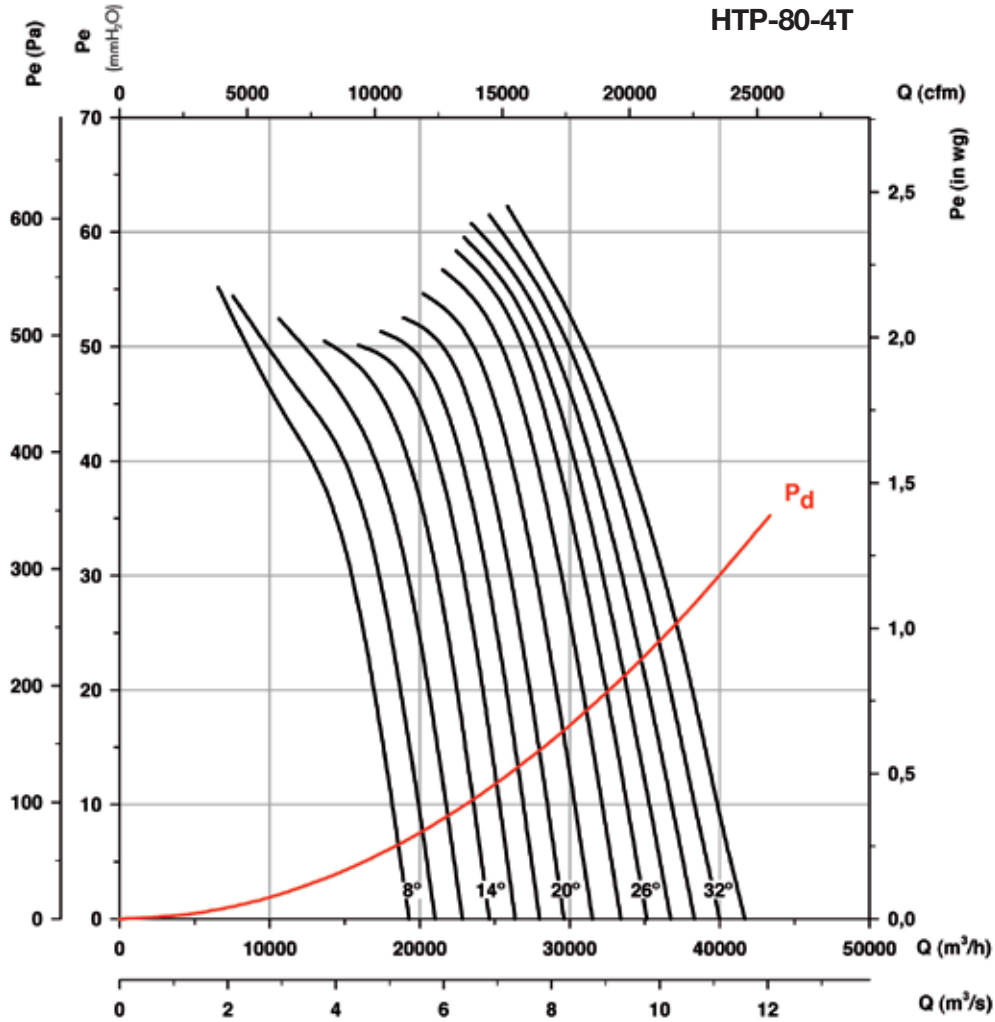

Potencia absorbida

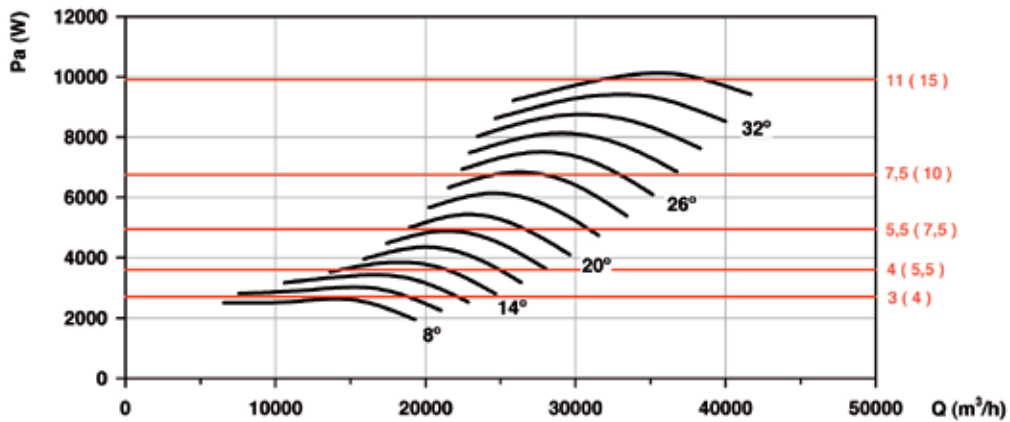

Potencia Motor Recomendada kW(CV)



Consultar características del punto de máxima eficiencia (BEP) al final de la serie.

**Curvas características**

Q= Caudal en m<sup>3</sup>/h, m<sup>3</sup>/s y cfm.

Pe= Presión estática en mmH<sub>2</sub>O, Pa e inwg.

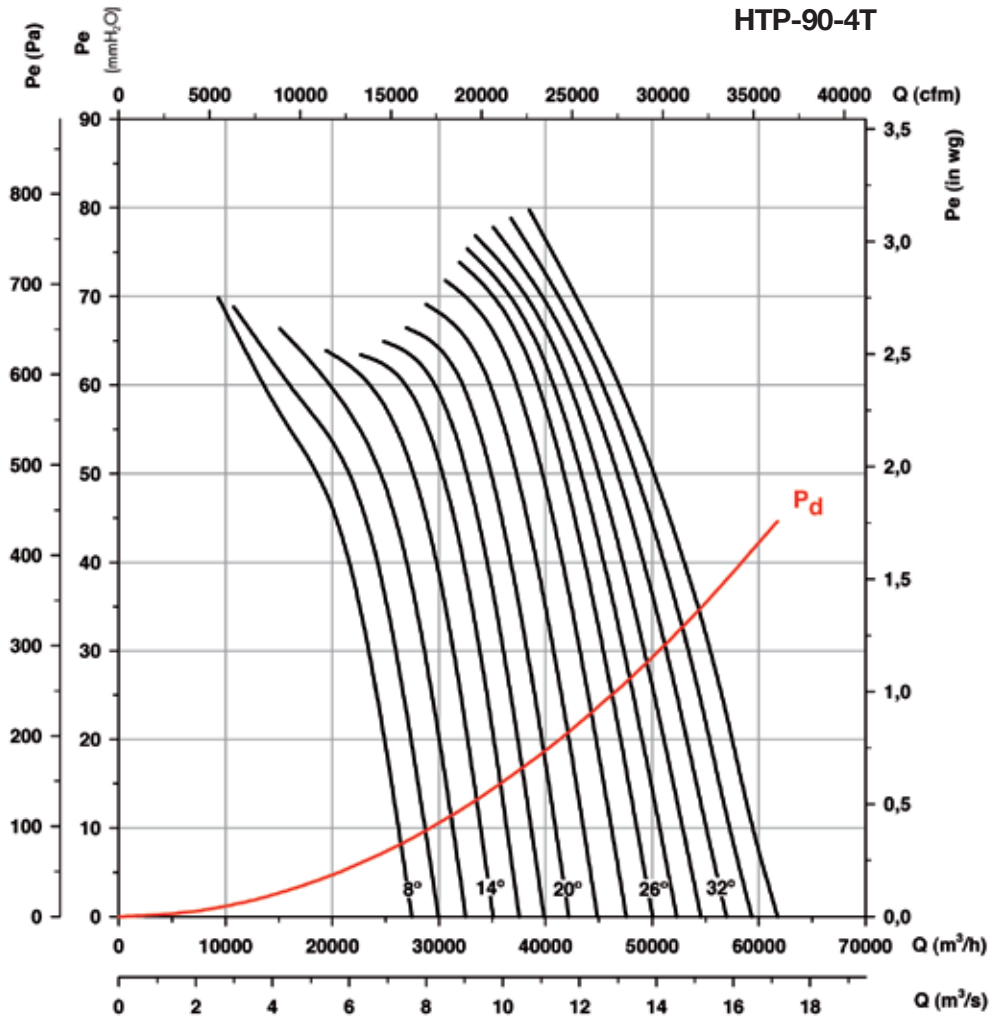

**Potencia absorbida**

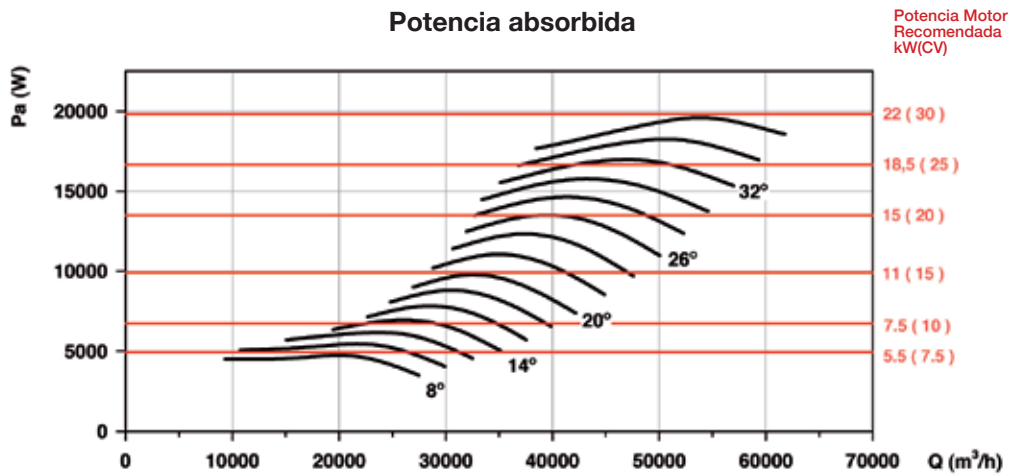

Consultar características del punto de máxima eficiencia (BEP) al final de la serie.

**Curvas características**

Q= Caudal en m<sup>3</sup>/h, m<sup>3</sup>/s y cfm.

Pe= Presión estática en mmH<sub>2</sub>O, Pa e inwg.

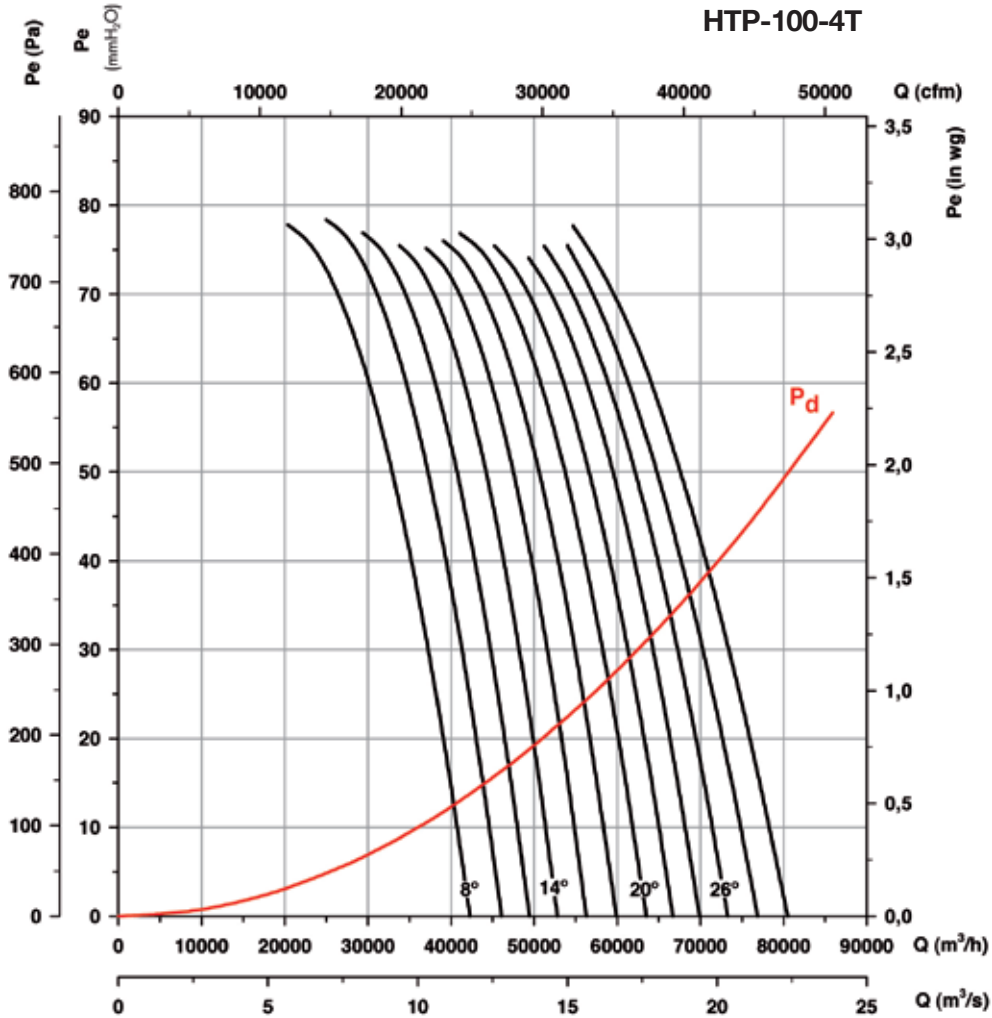

**Potencia absorbida**

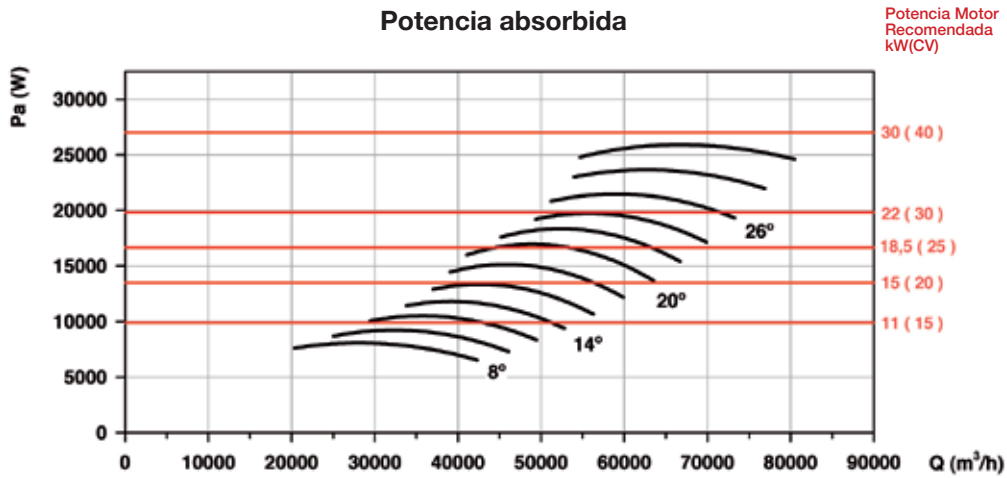

Consultar características del punto de máxima eficiencia (BEP) al final de la serie.



**Curvas características**

Q= Caudal en m<sup>3</sup>/h, m<sup>3</sup>/s y cfm.

Pe= Presión estática en mmH<sub>2</sub>O, Pa e inwg.

**HTP-125-4T**

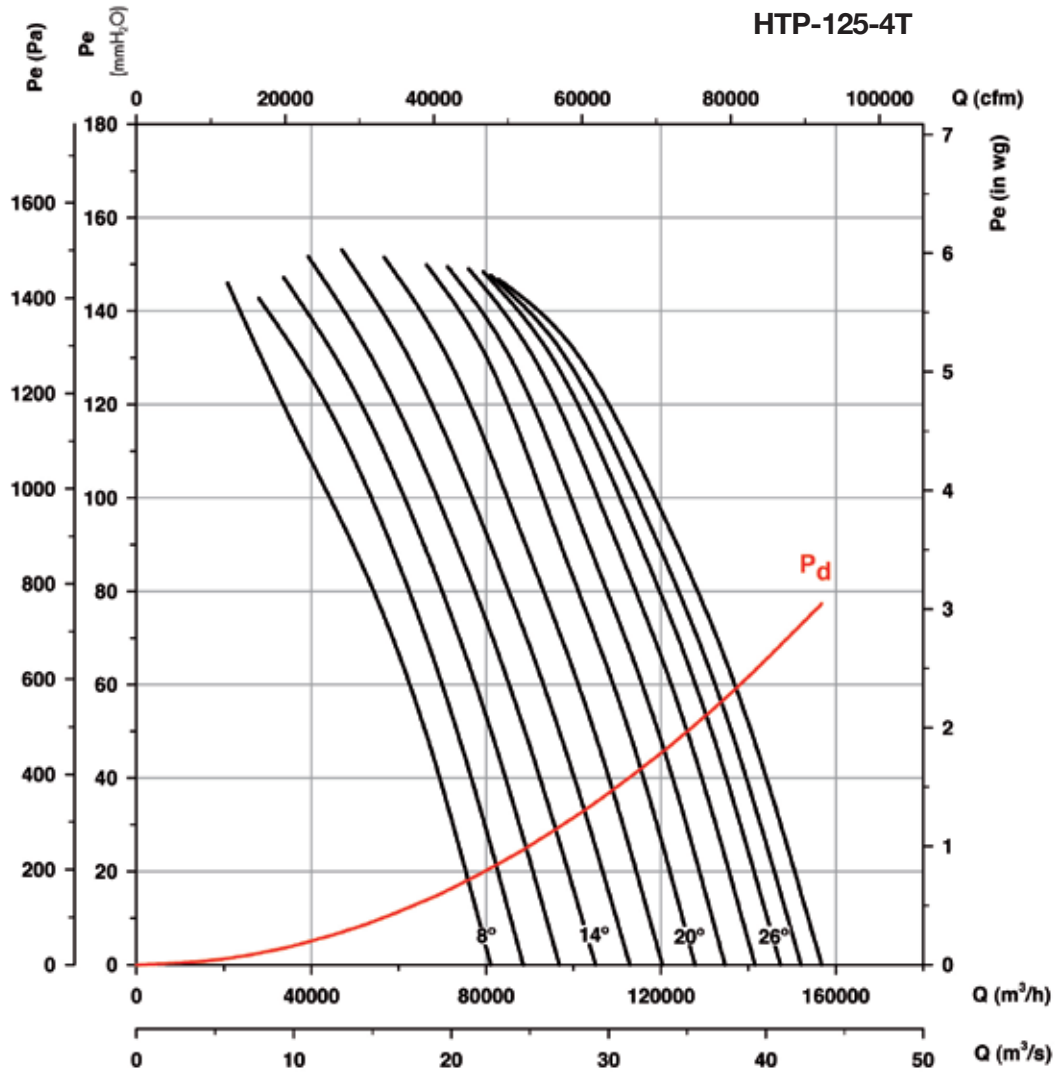

**Potencia absorbida**

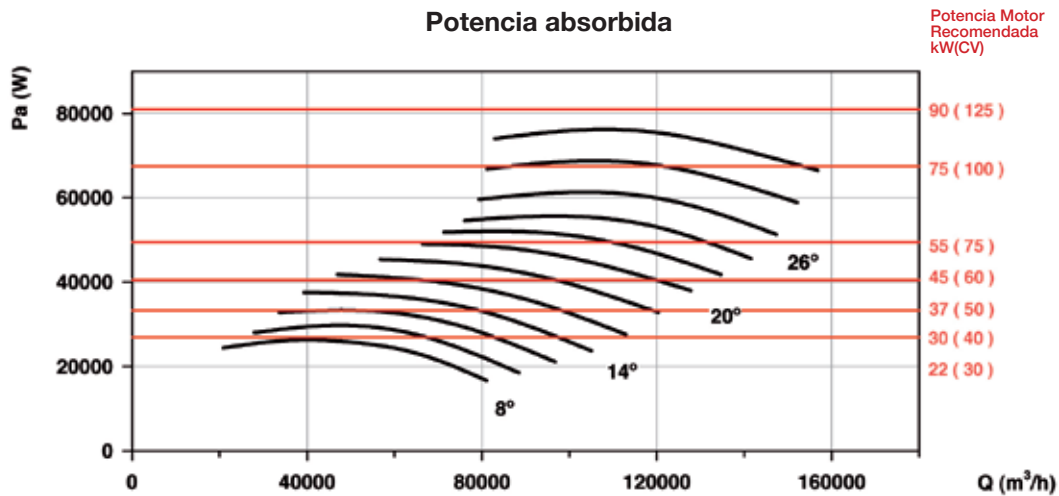

Consultar características del punto de máxima eficiencia (BEP) al final de la serie.



### Erp. Características del punto de máxima eficiencia (BEP)

α [°]	Ángulo inclinación palas en grados	SR	Relación específica
PN	Potencia nominal motor en kW	ηe [%]	Eficiencia
MC	Categoría de medición	N	Grado de eficiencia
EC	Categoría de eficiencia	[kW]	Potencia eléctrica
S	Estática	[m³/h]	Caudal
T	Total	[mmH₂O]	Presión estática o total (Según EC)
VSD	Variador de velocidad	[RPM]	Velocidad

#### HTP-50-2T

α [°]	PN	MC	EC	VSD	SR	ηe [%]	N	[kW]	[m³/h]	[mmH₂O]	[RPM]
8	2,2	C	S	NO	1,00	40,3%	45,0	1,797	6731	39,48	2888
10	2,2	C	S	NO	1,00	39,0%	43,2	2,167	7180	43,23	2864
12	3	C	S	NO	1,01	38,3%	42,1	2,485	7884	44,29	2914
14	3	C	S	NO	1,01	37,3%	40,7	2,832	8541	45,39	2901

#### HTP-56-2T

α [°]	PN	MC	EC	VSD	SR	ηe [%]	N	[kW]	[m³/h]	[mmH₂O]	[RPM]
8	2,2	C	S	NO	1,00	60,5%	65,0	1,914	10060	42,26	2880
10	3	C	S	NO	1,01	54,8%	58,6	2,491	10410	48,18	2913
12	3	C	S	NO	1,01	50,9%	54,2	3,018	11389	49,56	2895
14	4	C	S	NO	1,01	49,1%	52,0	3,526	11508	55,31	2907
16	5,5	C	S	NO	1,01	48,1%	50,6	4,046	13418	53,26	2940
18	5,5	C	S	NO	1,01	45,8%	47,9	4,663	14275	54,95	2931
20	5,5	C	S	NO	1,01	44,5%	46,3	5,246	15266	56,14	2923
22	7,5	B	T	NO	1,01	62,3%	63,9	5,628	18179	70,82	2953
24	7,5	B	T	NO	1,01	61,7%	63,0	6,221	19341	72,87	2948
26	7,5	B	T	NO	1,01	61,5%	62,6	6,790	20914	73,33	2943
28	11	B	T	NO	1,01	58,3%	59,0	7,701	21588	76,35	2965

#### HTP-63-2T

α [°]	PN	MC	EC	VSD	SR	ηe [%]	N	[kW]	[m³/h]	[mmH₂O]	[RPM]
8	7,5	C	S	NO	1,01	64,5%	66,1	5,570	13562	97,33	2953
10	7,5	C	S	NO	1,01	63,1%	64,3	6,421	14654	101,55	2946
12	7,5	C	S	NO	1,01	62,2%	63,1	7,263	15642	106,10	2939
14	11	C	S	NO	1,01	63,0%	63,6	7,921	16570	110,56	2964
16	11	C	S	NO	1,01	62,3%	62,7	8,998	17063	120,77	2959
18	11	C	S	NO	1,01	60,7%	60,8	10,117	18242	123,71	2954
20	15	C	S	NO	1,01	60,8%	60,8	11,191	20352	122,82	2962
22	15	C	S	NO	1,02	59,8%	59,7	12,107	19247	138,18	2959
24	15	C	S	NO	1,02	59,1%	58,9	13,433	21081	138,33	2955
26	18,5	C	S	NO	1,02	58,4%	58,2	14,667	23032	136,65	2960
28	18,5	C	S	NO	1,02	55,8%	55,5	16,491	23740	142,38	2955
30	22	C	S	NO	1,02	53,5%	53,1	18,286	24546	146,29	2961
32	22	C	S	NO	1,02	51,6%	51,1	20,097	25369	150,12	2958

#### HTP-63-4T

α [°]	PN	MC	EC	VSD	SR	ηe [%]	N	[kW]	[m³/h]	[mmH₂O]	[RPM]
8	0,75	C	S	NO	1,00	56,9%	63,9	0,790	6781	24,33	1424
10	1,1	C	S	NO	1,00	57,0%	63,7	0,888	7327	25,39	1460
12	1,1	C	S	NO	1,00	56,2%	62,5	1,005	7821	26,53	1455
14	1,1	C	S	NO	1,00	55,8%	61,8	1,118	8285	27,64	1450
16	1,5	C	S	NO	1,00	56,1%	61,8	1,251	8532	30,19	1458
18	1,5	C	S	NO	1,00	54,6%	60,0	1,407	9121	30,93	1453
20	1,5	C	S	NO	1,00	54,3%	59,4	1,566	10176	30,70	1448
22	2,2	C	S	NO	1,00	54,4%	59,3	1,664	9623	34,55	1458
24	2,2	C	S	NO	1,00	53,7%	58,4	1,846	10541	34,58	1454
26	2,2	C	S	NO	1,00	52,8%	57,2	2,029	11516	34,16	1449
28	2,2	C	S	NO	1,00	50,4%	54,5	2,281	11870	35,60	1443
30	3	C	S	NO	1,00	48,9%	52,7	2,500	12273	36,57	1443
32	3	C	S	NO	1,00	47,2%	50,7	2,747	12685	37,53	1437
34	3	C	S	NO	1,00	43,9%	47,1	3,045	13549	36,21	1430
36	4	C	S	NO	1,00	41,3%	44,3	3,334	14297	35,38	1457
38	4	C	S	NO	1,00	38,2%	41,0	3,590	15407	32,71	1453



## Erp. Características del punto de máxima eficiencia (BEP)

### HTP-71-2T

α [°]	PN	MC	EC	VSD	SR	ηe [%]	N	[kW]	[m³/h]	[mmH₂O]	[RPM]
8	11	C	S	NO	1,01	67,3%	67,3	9,953	20358	120,78	2955
10	15	C	S	NO	1,01	66,2%	66,2	11,111	21567	125,28	2963
12	15	C	S	NO	1,01	65,0%	65,0	12,390	22971	128,86	2958
14	15	C	S	NO	1,01	64,7%	64,6	13,631	23869	135,83	2954
16	18,5	C	S	NO	1,02	63,7%	63,5	15,300	26171	136,80	2958
18	18,5	C	S	NO	1,02	62,5%	62,1	17,059	29550	132,46	2953
20	22	C	S	NO	1,02	63,9%	63,5	18,637	28934	151,17	2961
22	22	C	S	NO	1,02	61,8%	61,3	21,024	31510	151,41	2956
24	30	C	S	NO	1,02	58,8%	58,2	23,898	34832	148,18	2970
26	30	C	S	NO	1,02	57,6%	57,0	26,188	37324	148,58	2967
28	30	C	S	NO	1,02	56,9%	56,2	27,718	37671	153,78	2966
30	30	C	S	NO	1,02	55,1%	54,3	30,068	38513	157,94	2963

### HTP-71-4T

α [°]	PN	MC	EC	VSD	SR	ηe [%]	N	[kW]	[m³/h]	[mmH₂O]	[RPM]
8	1,5	C	S	NO	1,00	60,5%	65,9	1,384	10179	30,19	1454
10	1,5	C	S	NO	1,00	59,1%	64,2	1,555	10783	31,32	1448
12	2,2	C	S	NO	1,00	59,1%	64,0	1,703	11486	32,22	1457
14	2,2	C	S	NO	1,00	58,9%	63,5	1,874	11935	33,96	1453
16	2,2	C	S	NO	1,00	57,6%	61,8	2,117	13085	34,20	1447
18	3	C	S	NO	1,00	57,2%	61,2	2,330	14775	33,11	1447
20	3	C	S	NO	1,00	58,4%	62,2	2,548	14467	37,79	1442
22	3	C	S	NO	1,00	56,5%	59,9	2,874	15755	37,85	1434
24	4	C	S	NO	1,00	54,1%	57,2	3,246	17416	37,04	1458
26	4	C	S	NO	1,00	53,0%	55,9	3,557	18662	37,15	1454
28	4	C	S	NO	1,00	52,4%	55,1	3,765	18836	38,44	1451
30	4	C	S	NO	1,00	50,7%	53,2	4,084	19256	39,49	1447
32	5,5	C	S	NO	1,01	50,6%	53,0	4,276	19555	40,65	1473
34	5,5	C	S	NO	1,01	48,4%	50,5	4,696	20811	40,15	1470
36	5,5	C	S	NO	1,01	45,9%	47,7	5,196	22143	39,56	1467
38	5,5	C	S	NO	1,01	44,0%	45,6	5,649	23383	39,07	1464

### HTP-80-4T

α [°]	PN	MC	EC	VSD	SR	ηe [%]	N	[kW]	[m³/h]	[mmH₂O]	[RPM]
8	3	C	S	NO	1,00	45,9%	49,1	3,042	12859	39,86	1431
10	4	C	S	NO	1,00	46,8%	49,7	3,466	14380	41,40	1455
12	4	C	S	NO	1,00	47,5%	50,1	3,949	15604	44,16	1449
14	4	C	S	NO	1,01	49,1%	51,3	4,404	16927	46,89	1443
16	5,5	C	S	NO	1,01	50,3%	52,3	4,871	18604	48,40	1469
18	5,5	C	S	NO	1,01	49,3%	51,0	5,411	19531	50,19	1465
20	7,5	C	S	NO	1,01	50,1%	51,6	5,798	20646	51,65	1476
22	7,5	C	S	NO	1,01	48,8%	50,0	6,481	21619	53,75	1473
24	7,5	C	S	NO	1,01	48,1%	49,0	7,157	22603	55,93	1470
26	11	C	S	NO	1,01	47,5%	48,3	7,708	23377	57,56	1481
28	11	C	S	NO	1,01	45,9%	46,4	8,313	23934	58,57	1479
30	11	C	S	NO	1,01	44,6%	44,9	8,948	24700	59,31	1478
32	11	C	S	NO	1,01	43,8%	44,0	9,386	24657	61,26	1477
34	11	C	S	NO	1,01	43,4%	43,5	10,030	25847	61,88	1475



## Erp. Características del punto de máxima eficiencia (BEP)

### HTP-90-4T

$\alpha$ [°]	PN	MC	EC	VSD	SR	$\eta_e$ [%]	N	[kW]	[m³/h]	[mmH₂O]	[RPM]
8	5,5	C	S	NO	1,01	47,2%	49,0	5,326	18308	50,44	1466
10	7,5	C	S	NO	1,01	48,9%	50,4	5,970	20475	52,40	1475
12	7,5	C	S	NO	1,01	49,7%	50,8	6,802	22217	55,88	1471
14	7,5	C	S	NO	1,01	51,3%	52,1	7,586	24102	59,35	1468
16	11	C	S	NO	1,01	52,4%	52,9	8,424	26488	61,25	1479
18	11	C	S	NO	1,01	51,4%	51,6	9,357	27809	63,53	1477
20	11	C	S	NO	1,01	50,7%	50,7	10,322	29396	65,37	1474
22	15	C	S	NO	1,01	49,8%	49,8	11,451	30782	68,03	1475
24	15	C	S	NO	1,01	49,0%	48,9	12,647	32182	70,79	1473
26	15	C	S	NO	1,01	47,9%	47,7	13,785	33285	72,85	1470
28	15	C	S	NO	1,01	46,3%	46,0	14,867	34077	74,13	1468
30	18,5	C	S	NO	1,01	45,1%	44,9	15,918	35169	75,07	1476
32	18,5	C	S	NO	1,01	44,4%	44,1	16,696	35107	77,54	1475
34	18,5	C	S	NO	1,01	44,0%	43,6	17,841	36802	78,32	1473
36	22	C	S	NO	1,01	44,0%	43,6	18,844	38497	79,11	1476

### HTP-100-4T

$\alpha$ [°]	PN	MC	EC	VSD	SR	$\eta_e$ [%]	N	[kW]	[m³/h]	[mmH₂O]	[RPM]
8	11	C	S	NO	1,01	57,7%	58,1	8,762	27276	68,06	1478
10	11	C	S	NO	1,01	59,3%	59,3	9,987	30265	71,90	1475
12	15	C	S	NO	1,01	58,3%	58,3	11,273	33345	72,39	1476
14	15	C	S	NO	1,01	57,0%	56,9	12,676	37128	71,54	1473
16	15	C	S	NO	1,01	54,7%	54,5	14,268	39472	72,67	1469
18	18,5	C	S	NO	1,01	52,3%	52,0	15,886	41007	74,43	1476
20	18,5	C	S	NO	1,01	50,1%	49,8	17,614	42917	75,60	1474
22	22	C	S	NO	1,01	49,5%	49,1	18,804	45347	75,35	1476
24	22	C	S	NO	1,01	48,6%	48,1	20,483	49344	74,08	1474
26	30	C	S	NO	1,01	47,6%	47,0	22,122	51228	75,43	1486
28	30	C	S	NO	1,01	45,4%	44,8	24,441	54000	75,47	1485
30	30	C	S	NO	1,01	44,0%	43,3	26,349	54700	77,79	1484

### HTP-125-4T

$\alpha$ [°]	PN	MC	EC	VSD	SR	$\eta_e$ [%]	N	[kW]	[m³/h]	[mmH₂O]	[RPM]
8	30	C	S	NO	1,01	44,0%	43,3	27,375	50255	88,10	1483
10	37	C	S	NO	1,01	47,0%	46,2	31,153	53478	100,67	1484
12	37	C	S	NO	1,01	49,1%	48,2	34,444	58117	106,95	1483
14	45	C	S	NO	1,01	51,4%	50,5	37,559	62762	113,08	1480
16	45	C	S	NO	1,01	52,9%	51,9	41,397	69294	116,17	1478
18	55	C	S	NO	1,01	54,2%	53,1	45,643	76423	118,93	1484
20	55	C	S	NO	1,01	55,2%	54,1	50,157	83496	121,90	1483
22	75	C	S	NO	1,01	55,2%	53,9	54,468	83497	132,17	1490
24	75	C	S	NO	1,02	55,3%	54,0	57,842	85592	137,26	1489
26	75	C	S	NO	1,02	52,7%	51,3	63,469	89569	137,11	1488
28	75	C	S	NO	1,02	48,3%	46,9	71,440	94123	134,68	1486
30	90	C	S	NO	1,02	45,0%	43,5	79,160	98798	132,55	1487

## Accesorios

Ver apartado accesorios.



INT

AR

VSD3/A-RFT  
VSD1/A-RFM

CUADROS

PL

P

PT/H

RT

BTUB

BAC

PS

S

SI

PV

# HBA

## Ventiladores helicoidales tubulares bifurcados, con motor fuera del flujo de aire



Ventiladores tubulares bifurcados para trasegar aire hasta 150°C en continuo y hasta 200°C de forma esporádica.



### Ventilador:

- Envoltente tubular en chapa de acero
- Hélice en fundición de aluminio
- Dirección de aire hélice-motor

### Motor:

- Motores de eficiencia IE2 para potencias iguales o superiores a 0,75kW e inferiores a 7,5kW, excepto monofásicos, 2 velocidades y 8 polos
- Motores clase F, con rodamientos a bolas, protección IP-55
- Trifásicos 230/400V.-50Hz (hasta 4 kW) y 400/690V.-50Hz. (potencias superiores a 4 kW)
- Temperatura de trabajo: -25°C. + 150°C

### Acabado:

- Anticorrosivo con pintura anticorrosiva para trabajar en ambientes de temperatura.

### Bajo demanda:

- Envoltente en acero inoxidable
- Acabado en galvanizado en caliente
- Bobinados especiales para diferentes tensiones y motores con PTC

## Código de pedido

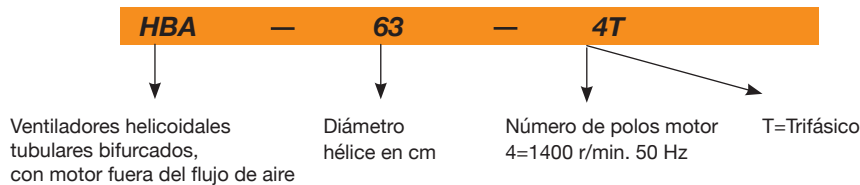

## Características técnicas

Modelo	Velocidad (r/min)	Intensidad máxima admisible (A)		Potencia instalada (kW)	Caudal máximo (m³/h)	Nivel presión sonora dB(A)	Peso aprox. (Kg)
		230V	400V				
HBA-31-2T	2760	2,57	1,49	0,55	2900	77	25
HBA-31-2M	2810	3,49	-	0,55	2900	77	26
HBA-31-4T	1350	1,66	0,96	0,25	1600	66	24
HBA-31-4M	1370	2,00	-	0,25	1600	66	25
HBA-40-2T	2860	4,20	2,40	1,10	6200	82	45
HBA-40-2M	2820	6,51	-	1,10	6200	82	46
HBA-40-4T	1370	2,02	1,17	0,37	3200	75	40
HBA-45-2T	2900	10,18	5,88	3,00	8550	84	57
HBA-50-4T	1410	3,10	1,79	0,75	6750	76	73
HBA-63-4T	1400	4,03	2,32	1,10	11150	77	91
HBA-71-4T	1440	14,10	8,12	4,00	15850	79	164
HBA-71-6T	900	2,99	1,73	0,55	11200	74	140
HBA-80-6T	945	4,88	2,82	1,10	14900	77	190
HBA-100-6T	945	4,88	2,82	1,10	21700	80	260

## Accesorios

Ver apartado accesorios.

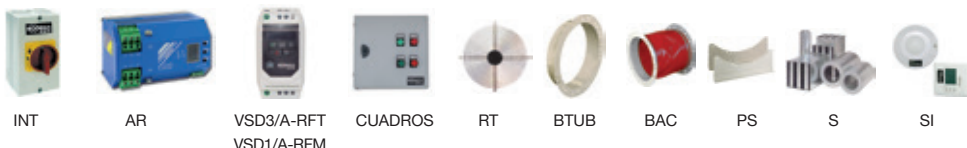

Dimensiones mm

HBA-31...50

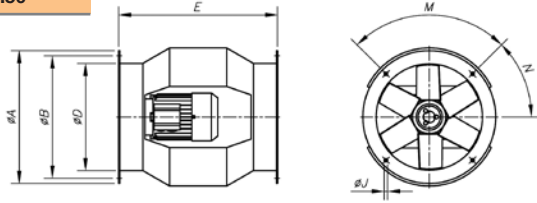

HBA-63...100

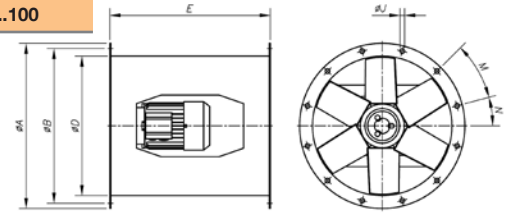

Modelo	ØA	ØB	ØD	E	ØJ	M	N
HBA-31	385	355	308	460	10	4x90°	45°
HBA-40	490	450	410	580	12	8x45°	22'5°
HBA-45	540	500	460	640	12	8x45°	22'5°
HBA-50	600	560	514	730	12	12x30°	15°
HBA-63	730	690	640	730	12	12x30°	15°
HBA-71	810	770	710	770	12	16x22'5°	11'25°
HBA-80	900	860	800	830	12	16x22'5°	11'25°
HBA-100	1115	1070	1000	1270	15	16x22'5°	11'25°

Curvas características

Q= Caudal en m<sup>3</sup>/h, m<sup>3</sup>/s y cfm.

Pe= Presión estática en mmH<sub>2</sub>O, Pa e inwg.

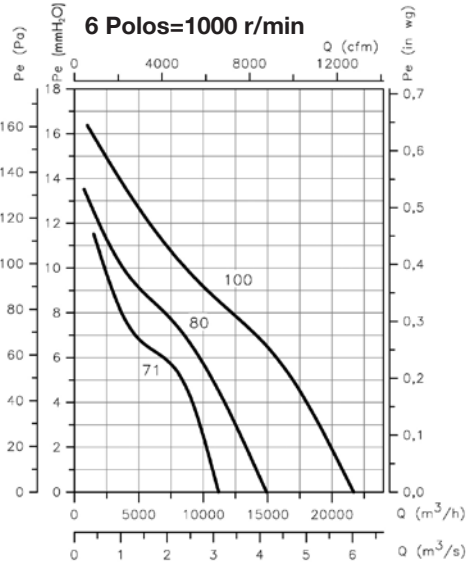
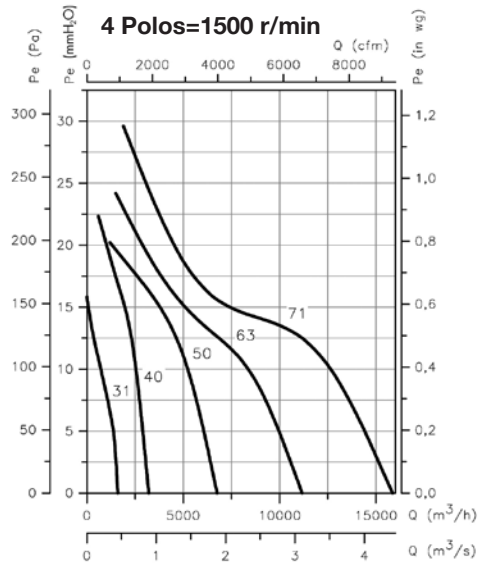
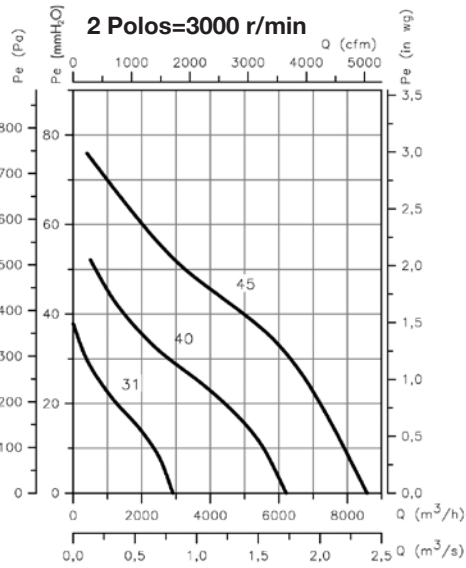

# HPX/SEC



**Ventiladores diseñados con la mejor tecnología y experiencia para soportar las extremas condiciones de trabajo en hornos, secaderos y otras aplicaciones con temperatura y humedad**



**Ventilador:**

- Envoltorio tubular con tapa giratoria, en chapa de acero de gran grosor
- Hélices en fundición de aluminio
- Rodamientos de alta calidad, con grasa para altas temperaturas
- Soporte rodamientos con engrasadores
- Engrasadores externos en envoltorio ventilador
- Dirección aire motor-hélice

**Motor:**

- Motores de eficiencia IE2 para potencias iguales o superiores a 0,75kW e inferiores a 7,5kW, excepto monofásicos, 2 velocidades y 8 polos
- Motores de eficiencia IE3 para potencias iguales o superiores a 7,5kW, excepto monofásicos, 2 velocidades y 8 polos
- Motores clase F, con rodamientos a bolas, protección IP55
- Monofásicos 230V-50Hz, y trifásicos 230/400V-50Hz(hasta 4kW) y 400/690V-50Hz(potencias superiores a 4kW)
- Temperatura de trabajo: -25°C +150°C

**Acabado:**

- Anticorrosivo en pintura anticorrosiva

**Bajo demanda:**

- Dirección aire hélice-motor
- Hélices reversibles 100%
- Bobinados especiales para diferentes tensiones
- Certificación ATEX Categoría 2 (HPX/ATEX)
- Motores de eficiencias IE2 e IE3 para cualquier potencia

**Código de pedido**

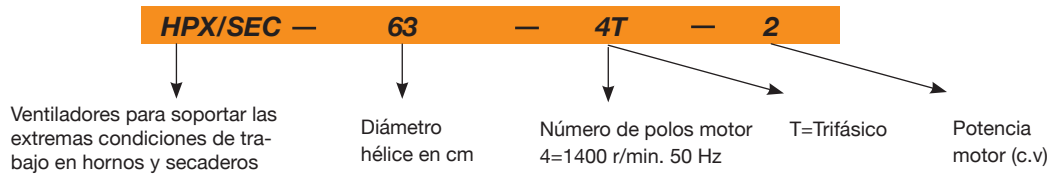

**Características técnicas**

Modelo	Velocidad (r/min)	Intensidad máxima admisible (A)			Potencia instalada (kW)	Caudal máximo (m³/h)	Nivel presión sonora dB(A)	Peso aprox. (Kg)
		230V	400V	690V				
HPX/SEC-63-4T-2	1450	5,96	3,44		1,50	17500	78	68,1
HPX/SEC-71-4T-2	1350	5,96	3,44		1,50	22500	79	84,5
HPX/SEC-71-4T-3	1450	8,36	4,83		2,20	24000	81	91,5
HPX/SEC-80-4T-4	1350	10,96	6,33		3,00	32000	84	107,0
HPX/SEC-80-4T-5.5	1450	14,10	8,12		4,00	40500	84	116,0
HPX/SEC-90-4T-7.5	1400		11,60	6,72	5,50	51000	91	132,5
HPX/SEC-90-4T-10 IE3	1400		14,20	8,20	7,50	54700	92	145,5
HPX/SEC-100-4T-10 IE3	1450		14,20	8,20	7,50	63000	93	148,5
HPX/SEC-100-4T-15 IE3	1450		20,20	11,60	11,00	68000	94	191,5

**Características acústicas**

Los valores indicados, se determinan mediante medidas de nivel de presión y potencia sonora en dB(A) obtenidas en campo libre a una distancia equivalente a dos veces la envergadura del ventilador más el diámetro de la hélice, con un mínimo de 1,5 mts.

Espectro de potencia sonora Lw(A) en dB(A) banda de frecuencia en [Hz]

Modelo	63	125	250	500	1000	2000	4000	8000	Modelo	63	125	250	500	1000	2000	4000	8000
HPX/SEC-63-4T-2	62	73	83	89	90	85	74	70	HPX/SEC-90-4T-7.5	69	90	97	102	105	101	94	83
HPX/SEC-71-4T-2	56	76	84	89	91	88	81	70	HPX/SEC-90-4T-10	70	91	98	103	106	102	95	84
HPX/SEC-71-4T-3	65	76	86	92	93	88	77	73	HPX/SEC-100-4T-10	73	93	100	106	108	105	98	87
HPX/SEC-80-4T-4	61	81	89	94	96	93	86	75	HPX/SEC-100-4T-15	74	94	101	107	109	106	99	88
HPX/SEC-80-4T-5.5	68	79	89	95	96	91	80	76									

**Dimensiones mm**

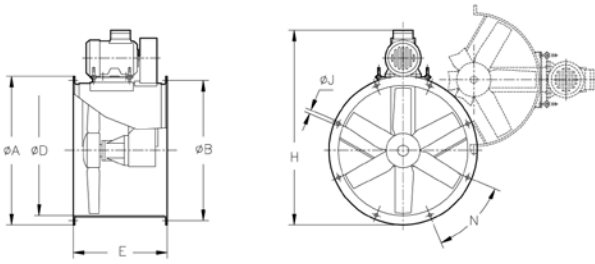

Modelo	ØA	ØB	ØD	E	H	ØJ	N
HPX/SEC-63-4T-2	730	690	640	500	943	12	12x30°
HPX/SEC-71-4T-2	810	770	710	550	1022	12	16x22°30'
HPX/SEC-71-4T-3	810	770	710	550	1048	12	16x22°30'
HPX/SEC-80-4T-4	900	860	800	600	1164,5	12	16x22°30'
HPX/SEC-80-4T-5,5	900	860	800	600	1185,5	13	16x22°30'
HPX/SEC-90-4T-7,5	1015	970	900	650	1338	15	16x22°30'
HPX/SEC-90-4T-10	1015	970	900	650	1338	15	16x22°30'
HPX/SEC-100-4T-10	1115	1070	1000	750	1453	15	16x22°30'
HPX/SEC-100-4T-15	1115	1070	1000	750	1525	15	16x22°30'

**Curvas características**

Q= Caudal en m³/h, m³/s y cfm.

Pe= Presión estática en mmH₂O, Pa e inwg.

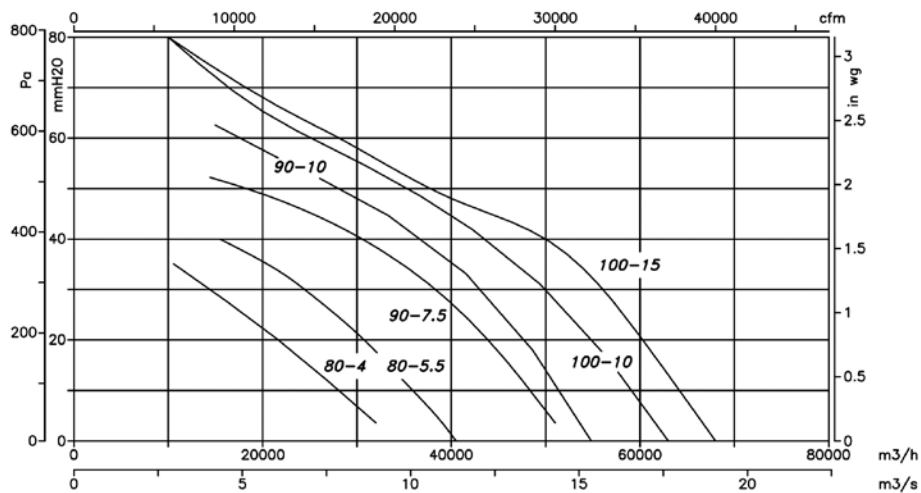
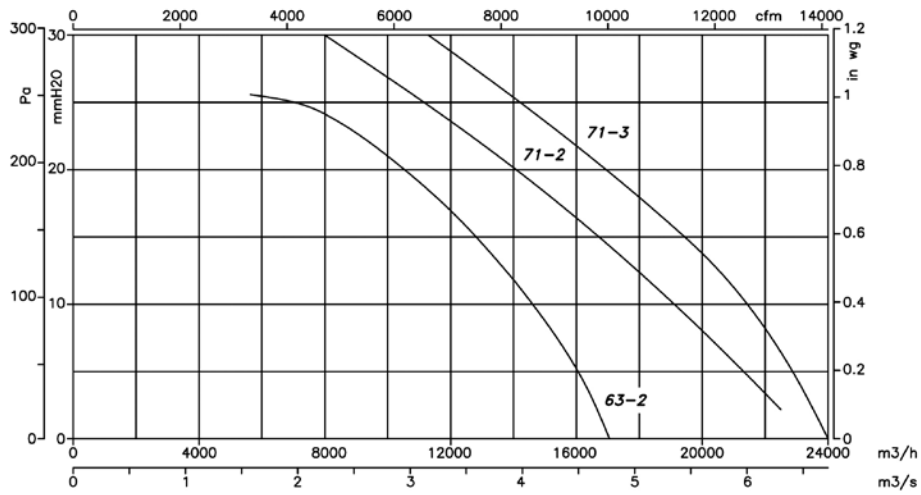

**Accesorios**

Ver apartado accesorios.

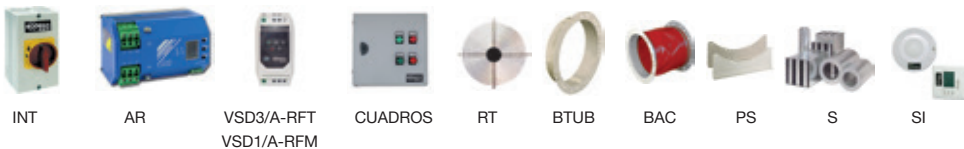



# HGT HGTX

**HGT: Ventiladores helicoidales tubulares de gran diámetro, con motor directo**

**HGTX: Ventiladores helicoidales tubulares de gran diámetro, con motor exterior**

Ventiladores helicoidales tubulares, equipados con hélices de aluminio de 3, 6 ó 9 álabes con diversos ángulos de inclinación.



HGT



HGTX

Ventilador:

- Dirección aire motor-hélice
- Hélices en fundición de aluminio de 3, 6 ó 9 álabes, con ángulo de inclinación ajustable.
- Envoltente tubular en chapa de acero
- HGT: La versión standard es de carcasa corta. La versión en carcasa larga está equipada con trampilla de inspección.
- HGTX: Versión standard en carcasa larga, equipada con trampilla de inspección

Motor:

- Motores de eficiencia IE3 para potencias iguales o superiores a 7,5kW, excepto monofásicos, 2 velocidades y 8 polos
- Motores de eficiencia IE2 para potencias iguales o superiores a 0,75kW e inferiores a 7,5kW, excepto monofásicos, 2 velocidades y 8 polos
- Motores clase F, con rodamientos a bolas, protección IP55
- Trifásicos 230/400V-50Hz (hasta 4kW) y 400/690V-50Hz (potencias superiores a 4kW)
- Temperatura de trabajo:  
HGT: -25°C +50°C  
HGTX: -25°C +120°C

Acabado:

- Anticorrosivo en resina de poliéster polimerizada a 190 °C, previo desengrase con tratamiento nanotecnológico libre de fosfatos.

Bajo demanda:

- Dirección aire hélice-motor.
- Hélices reversibles 100%.
- Bobinados especiales para diferentes tensiones.
- Certificación ATEX Categoría 2
- HGT: Ventiladores con carcasa larga equipada con trampilla de inspección
- Motores de dos velocidades
- Motores de eficiencias IE2 e IE3 para cualquier potencia

## Código de pedido

**HGT — 125 — 4T — 6-20 — 10° — PV**

HGT: Ventiladores helicoidales tubulares de gran diámetro, con motor directo  
HGTX: Ventiladores helicoidales tubulares de gran diámetro, con motor exterior

Diámetro hélice en cm

Número de polos motor T=Trifásico  
4=1400 r/min. 50 Hz  
6=900 r/min. 50 Hz  
8=750 r/min. 50 Hz

Número de palas  
3 palas  
6 palas  
9 palas

Potencia motor (CV)

Ángulo inclinación palas

PV=Pabellón de aspiración



## Características técnicas

Modelo	Velocidad (r/min)	Intensidad máx admisible (A)			Potencia instalada (kW)	Caudal máximo (m³/h)	Nivel presión sonora dB(A)	Peso aprox. (Kg)		
		230V	400V	690V				HGT Larga	HGTX Corta	
HGT-125-4T/3-10 IE3	HGTX-125-4T/3-10 IE3	1465	13,90	8,06	7,50	58150	88	227	194	358
HGT-125-4T/3-15 IE3	HGTX-125-4T/3-15 IE3	1470	20,90	12,10	11,00	77450	89	274	246	394
HGT-125-4T/3-20 IE3	HGTX-125-4T/3-20 IE3	1465	27,90	16,20	15,00	91400	91	285	257	405
HGT-125-4T/3-25 IE3	HGTX-125-4T/3-25 IE3	1470	35,10	20,30	18,50	98350	91	363	320	450
HGT-125-4T/3-30 IE3	HGTX-125-4T/3-30 IE3	1470	41,00	23,80	22,00	110500	92	363	320	450
HGT-125-4T/3-40 IE3	HGTX-125-4T/3-40 IE3	1480	57,10	33,10	30,00	120850	93	468	425	557
HGT-125-4T/3-50 IE3	HGTX-125-4T/3-50 IE3	1480	69,20	40,10	37,00	129000	94	551	495	622
HGT-125-4T/3-60 IE3	HGTX-125-4T/3-60 IE3	1475	80,90	46,90	45,00	140000	95	589	533	660
HGT-125-4T/6-20 IE3	HGTX-125-4T/6-20 IE3	1465	27,90	16,20	15,00	78300	89	294	266	414
HGT-125-4T/6-25 IE3	HGTX-125-4T/6-25 IE3	1470	35,10	20,30	18,50	92000	90	372	329	459
HGT-125-4T/6-30 IE3	HGTX-125-4T/6-30 IE3	1470	41,00	23,80	22,00	98100	90	372	329	459
HGT-125-4T/6-40 IE3	HGTX-125-4T/6-40 IE3	1480	57,10	33,10	30,00	117000	92	477	433	566
HGT-125-4T/6-50 IE3	HGTX-125-4T/6-50 IE3	1480	69,20	40,10	37,00	123700	93	560	504	631
HGT-125-4T/6-60 IE3	HGTX-125-4T/6-60 IE3	1475	80,90	46,90	45,00	136000	94	598	542	669
HGT-125-4T/6-75 IE3	HGTX-125-4T/6-75 IE3	1480	98,60	57,20	55,00	148000	95	614	564	700
HGT-125-4T/6-100 IE3	HGTX-125-4T/6-100 IE3	1485	134,00	77,70	75,00	161000	96	708	658	794

### Características técnicas

Modelo	Velocidad (r/min)	Intensidad máx admisible (A)			Potencia instalada (kW)	Caudal máximo (m³/h)	Nivel presión sonora dB(A)	Peso aprox. (Kg)			
		230V	400V	690V				Larga	HGT Corta	HGTX	
HGT-125-4T/9-25 IE3	HGTX-125-4T/9-25 IE3	1470		35,10	20,30	18,50	79750	88	381	338	468
HGT-125-4T/9-30 IE3	HGTX-125-4T/9-30 IE3	1470		41,00	23,80	22,00	97000	89	381	338	468
HGT-125-4T/9-40 IE3	HGTX-125-4T/9-40 IE3	1480		57,10	33,10	30,00	111200	91	486	442	575
HGT-125-4T/9-50 IE3	HGTX-125-4T/9-50 IE3	1480		69,20	40,10	37,00	118350	93	569	513	640
HGT-125-4T/9-60 IE3	HGTX-125-4T/9-60 IE3	1475		80,90	46,90	45,00	127000	94	607	551	678
HGT-125-4T/9-75 IE3	HGTX-125-4T/9-75 IE3	1480		98,60	57,20	55,00	142000	95	623	573	709
HGT-125-4T/9-100 IE3	HGTX-125-4T/9-100 IE3	1485		134,00	77,70	75,00	155000	99	717	667	803
HGT-125-6T/3-4	HGTX-125-6T/3-4	960	12,70	7,33		3,00	46550	79	204	171	335
HGT-125-6T/3-5.5	HGTX-125-6T/3-5.5	960	16,50	9,53		4,00	55300	80	209	176	340
HGT-125-6T/3-7.5	HGTX-125-6T/3-7.5	975		11,50	6,64	5,50	64450	81	217	184	348
HGT-125-6T/3-10 IE3	HGTX-125-6T/3-10 IE3	975		14,80	8,58	7,50	76400	83	297	269	417
HGT-125-6T/3-15 IE3	HGTX-125-6T/3-15 IE3	975		21,90	12,70	11,00	87050	84	298	270	418
HGT-125-6T/3-20 IE3	HGTX-125-6T/3-20 IE3	975		28,20	16,30	15,00	91700	85	407	364	494
HGT-125-6T/6-5.5	HGTX-125-6T/6-5.5	960	16,50	9,53		4,00	51300	77	218	185	349
HGT-125-6T/6-7.5	HGTX-125-6T/6-7.5	975		11,50	6,64	5,50	60300	77	226	193	357
HGT-125-6T/6-10 IE3	HGTX-125-6T/6-10 IE3	975		14,80	8,58	7,50	72250	79	306	278	426
HGT-125-6T/6-15 IE3	HGTX-125-6T/6-15 IE3	975		21,90	12,70	11,00	85450	81	307	279	427
HGT-125-6T/6-20 IE3	HGTX-125-6T/6-20 IE3	975		28,20	16,30	15,00	92850	82	416	373	503
HGT-125-6T/6-25 IE3	HGTX-125-6T/6-25 IE3	980		35,90	20,80	18,50	103000	84	449	405	538
HGT-125-6T/9-10 IE3	HGTX-125-6T/9-10 IE3	975		14,80	8,58	7,50	68200	78	315	287	435
HGT-125-6T/9-15 IE3	HGTX-125-6T/9-15 IE3	975		21,90	12,70	11,00	77550	81	316	288	436
HGT-125-6T/9-20 IE3	HGTX-125-6T/9-20 IE3	975		28,20	16,30	15,00	92900	84	425	382	512
HGT-125-6T/9-25 IE3	HGTX-125-6T/9-25 IE3	980		35,90	20,80	18,50	98700	85	458	414	547
HGT-125-6T/9-30 IE3	HGTX-125-6T/9-30 IE3	980		42,40	24,60	22,00	104000	87	463	419	552
HGT-125-8T/3-3	HGTX-125-8T/3-3	705	9,53	5,50		2,20	48800	71	209	176	340
HGT-125-8T/3-4	HGTX-125-8T/3-4	705	12,82	7,40		3,00	54900	71	216	183	347
HGT-125-8T/3-5.5	HGTX-125-8T/3-5.5	710	16,11	9,30		4,00	62100	73	249	221	369
HGT-125-8T/3-7.5	HGTX-125-8T/3-7.5	725		12,70	7,33	5,50	69500	75	262	234	382
HGT-125-8T/6-3	HGTX-125-8T/6-3	705	9,53	5,50		2,20	45700	69	218	185	349
HGT-125-8T/6-4	HGTX-125-8T/6-4	705	12,82	7,40		3,00	51800	71	225	192	356
HGT-125-8T/6-5.5	HGTX-125-8T/6-5.5	710	16,11	9,30		4,00	61500	72	258	230	378
HGT-125-8T/6-7.5	HGTX-125-8T/6-7.5	725		12,70	7,33	5,50	67500	73	271	243	391
HGT-125-8T/6-10	HGTX-125-8T/6-10	725		17,00	9,81	7,50	75500	75	301	273	421
HGT-125-8T/9-4	HGTX-125-8T/9-4	705	12,82	7,40		3,00	48200	70	234	201	365
HGT-125-8T/9-5.5	HGTX-125-8T/9-5.5	710	16,11	9,30		4,00	55200	73	267	239	387
HGT-125-8T/9-7.5	HGTX-125-8T/9-7.5	725		12,70	7,33	5,50	67000	75	280	252	400
HGT-125-8T/9-10	HGTX-125-8T/9-10	725		17,00	9,81	7,50	74750	76	310	282	430
HGT-125-8T/9-15	HGTX-125-8T/9-15	725		21,70	12,53	11,00	80800	79	372	329	459
HGT-140-6T/3-4		960	12,70	7,33		3,00	51000	82	251	214	
HGT-140-6T/3-5.5		960	16,50	9,53		4,00	56700	83	258	221	
HGT-140-6T/3-7.5		975		11,50	6,64	5,50	67900	84	266	229	
HGT-140-6T/3-10 IE3		975		14,80	8,58	7,50	80100	85	355	316	
HGT-140-6T/3-15 IE3		975		21,90	12,70	11,00	96900	86	356	317	
HGT-140-6T/3-20 IE3		975		28,20	16,30	15,00	106000	88	463	413	
HGT-140-6T/6-5.5		960	16,50	9,53		4,00	58000	82	268	231	
HGT-140-6T/6-7.5		975		11,50	6,64	5,50	66000	84	276	239	
HGT-140-6T/6-10 IE3		975		14,80	8,58	7,50	80700	85	365	326	
HGT-140-6T/6-15 IE3		975		21,90	12,70	11,00	96700	86	366	327	
HGT-140-6T/6-20 IE3		975		28,20	16,30	15,00	104000	87	472	423	
HGT-140-6T/6-25 IE3		980		35,90	20,80	18,50	115000	88	506	457	
HGT-140-6T/6-30 IE3		980		42,40	24,60	22,00	119000	89	511	462	
HGT-140-6T/9-10 IE3		975		14,80	8,58	7,50	70000	84	374	335	
HGT-140-6T/9-15 IE3		975		21,90	12,70	11,00	86000	86	375	336	
HGT-140-6T/9-20 IE3		975		28,20	16,30	15,00	97500	87	482	432	
HGT-140-6T/9-25 IE3		980		35,90	20,80	18,50	111000	88	515	467	
HGT-140-6T/9-30 IE3		980		42,40	24,60	22,00	118500	89	520	472	
HGT-140-6T/9-40 IE3		985		55,40	32,10	30,00	132000	91	676	614	
HGT-140-6T/9-50 IE3		985		67,20	39,00	37,00	139000	92	693	638	
HGT-140-8T/3-3		705	9,53	5,50		2,20	50000	78	258	221	

**Características técnicas**

Modelo	Velocidad (r/min)	Intensidad máx admisible (A)			Potencia instalada (kW)	Caudal máximo (m³/h)	Nivel presión sonora dB(A)	Peso aprox. (Kg)		HGTX
		230V	400V	690V				HGT Larga	HGT Corta	
HGT-140-8T/3-4	705	12,82	7,40		3,00	57000	78	265	228	
HGT-140-8T/3-5.5	710	16,11	9,30		4,00	65400	79	307	268	
HGT-140-8T/3-7.5	725		12,70	7,33	5,50	77500	81	320	281	
HGT-140-8T/3-10	725		17,00	9,81	7,50	86000	82	350	311	
HGT-140-8T/6-3	705	9,53	5,50		2,20	47500	78	268	231	
HGT-140-8T/6-4	705	12,82	7,40		3,00	57600	79	275	238	
HGT-140-8T/6-5.5	710	16,11	9,30		4,00	65200	80	317	278	
HGT-140-8T/6-7.5	725		12,70	7,33	5,50	73300	81	330	291	
HGT-140-8T/6-10	725		17,00	9,81	7,50	82200	82	360	321	
HGT-140-8T/6-15	725		21,70	12,53	11,00	94200	83	419	370	
HGT-140-8T/9-4	705	12,82	7,40		3,00	47200	79	284	247	
HGT-140-8T/9-5.5	710	16,11	9,30		4,00	64400	79	326	287	
HGT-140-8T/9-7.5	725		12,70	7,33	5,50	69200	81	339	300	
HGT-140-8T/9-10	725		17,00	9,81	7,50	78700	82	369	330	
HGT-140-8T/9-15	725		21,70	12,53	11,00	94300	83	429	379	
HGT-140-8T/9-20	725		31,70	18,30	15,00	103000	86	485	437	
HGT-160-6T/3-5.5	960	16,50	9,53		4,00	66000	81	327	275	
HGT-160-6T/3-7.5	975		11,50	6,64	5,50	76100	82	335	283	
HGT-160-6T/3-10 IE3	975		14,80	8,58	7,50	84000	83	428	374	
HGT-160-6T/3-15 IE3	975		21,90	12,70	11,00	102000	85	429	375	
HGT-160-6T/3-20 IE3	975		28,20	16,30	15,00	127000	86	549	480	
HGT-160-6T/3-25 IE3	980		35,90	20,80	18,50	136700	87	583	513	
HGT-160-6T/3-30 IE3	980		42,40	24,60	22,00	145000	89	588	518	
HGT-160-6T/6-10 IE3	975		14,80	8,58	7,50	75000	83	439	385	
HGT-160-6T/6-15 IE3	975		21,90	12,70	11,00	93500	85	440	386	
HGT-160-6T/6-20 IE3	975		28,20	16,30	15,00	120500	86	559	490	
HGT-160-6T/6-25 IE3	980		35,90	20,80	18,50	130000	87	593	524	
HGT-160-6T/6-30 IE3	980		42,40	24,60	22,00	140000	88	598	529	
HGT-160-6T/6-40 IE3	985		55,40	32,10	30,00	158000	89	771	672	
HGT-160-6T/6-50 IE3	985		67,20	39,00	37,00	171000	91	784	699	
HGT-160-6T/9-15 IE3	975		21,90	12,70	11,00	87000	85	450	396	
HGT-160-6T/9-20 IE3	975		28,20	16,30	15,00	104000	86	569	500	
HGT-160-6T/9-25 IE3	980		35,90	20,80	18,50	127000	87	603	534	
HGT-160-6T/9-30 IE3	980		42,40	24,60	22,00	135000	88	608	539	
HGT-160-6T/9-40 IE3	985		55,40	32,10	30,00	147000	89	781	682	
HGT-160-6T/9-50 IE3	985		67,20	39,00	37,00	165000	90	794	710	
HGT-160-6T/9-60 IE3	985		84,40	48,90	45,00	177000	91	1019	920	
HGT-160-6T/9-75 IE3	985		103,00	59,70	55,00	193000	92	1077	978	
HGT-160-6T/9-100 IE3	990		139,00	80,60	75,00	207500	93	1232	1133	
HGT-160-8T/3-3	705	9,53	5,50		2,20	54000	76	327	275	
HGT-160-8T/3-4	705	12,82	7,40		3,00	57500	77	334	282	
HGT-160-8T/3-5.5	710	16,11	9,30		4,00	74000	79	380	326	
HGT-160-8T/3-7.5	725		12,70	7,33	5,50	83500	80	393	339	
HGT-160-8T/3-10	725		17,00	9,81	7,50	97500	81	423	369	
HGT-160-8T/3-15	725		21,70	12,53	11,00	115000	83	496	427	
HGT-160-8T/6-4	705	12,82	7,40		3,00	70900	76	344	292	
HGT-160-8T/6-5.5	710	16,11	9,30		4,00	84500	77	391	337	
HGT-160-8T/6-7.5	725		12,70	7,33	5,50	77000	79	404	350	
HGT-160-8T/6-10	725		17,00	9,81	7,50	95000	80	434	380	
HGT-160-8T/6-15	725		21,70	12,53	11,00	109000	82	506	437	
HGT-160-8T/6-20	725		31,70	18,30	15,00	123000	83	563	494	
HGT-160-8T/6-25	725		35,85	20,70	18,50	130000	84	641	542	
HGT-160-8T/9-7.5	725		12,70	7,33	5,50	70000	79	414	360	
HGT-160-8T/9-10	725		17,00	9,81	7,50	87000	80	444	390	
HGT-160-8T/9-15	725		21,70	12,53	11,00	103000	82	516	447	
HGT-160-8T/9-20	725		31,70	18,30	15,00	117000	83	573	504	
HGT-160-8T/9-25	725		35,85	20,70	18,50	133000	84	651	552	
HGT-160-8T/9-30	725		41,60	24,02	22,00	140000	85	666	567	
HGT-160-8T/9-40	730		60,79	35,10	30,00	151000	86	724	640	

**Características acústicas**

Los valores indicados, se determinan mediante medidas de nivel de presión y potencia sonora en dB(A) obtenidas en campo libre a una distancia equivalente a dos veces la envergadura del ventilador más el diámetro de la hélice, con un mínimo de 1,5 mts.

**Espectro de potencia sonora Lw(A) en dB(A) por banda de frecuencia en Hz**

Modelo	63	125	250	500	1000	2000	4000	8000	Modelo	63	125	250	500	1000	2000	4000	8000
125-4T/3-10	70	76	88	98	98	94	86	82	140-6T/9-10	66	84	93	92	91	87	78	73
125-4T/3-15	71	77	89	99	99	95	87	83	140-6T/9-15	67	85	94	93	92	88	79	74
125-4T/3-20	72	78	90	100	100	96	88	84	140-6T/9-20	69	87	96	95	94	90	81	76
125-4T/3-25	73	79	91	101	101	97	89	85	140-6T/9-25	70	88	97	96	95	91	82	77
125-4T/3-30	74	80	92	102	102	98	90	86	140-6T/9-30	70	88	97	96	95	91	82	77
125-4T/3-40	75	81	93	103	103	99	91	87	140-6T/9-40	71	89	98	97	96	92	83	78
125-4T/3-50	76	82	94	104	104	100	92	88	140-6T/9-50	74	92	101	100	99	95	86	81
125-4T/3-60	77	83	95	105	105	101	93	89	140-8T/3-3	60	70	78	83	82	81	68	63
125-4T/6-20	66	74	90	97	99	94	88	84	140-8T/3-4	64	74	82	87	86	85	72	67
125-4T/6-25	67	75	91	98	100	95	89	85	140-8T/3-5,5	65	75	83	88	87	86	73	68
125-4T/6-30	68	76	92	99	101	96	90	86	140-8T/3-7,5	66	76	84	89	88	87	74	69
125-4T/6-40	69	77	93	100	102	97	91	87	140-8T/3-10	68	78	86	91	90	89	76	71
125-4T/6-50	71	79	95	102	104	99	93	89	140-8T/6-3	61	73	82	86	84	78	68	65
125-4T/6-60	72	80	96	103	105	100	94	90	140-8T/6-4	63	75	84	88	86	80	70	67
125-4T/6-75	72	80	96	103	105	100	94	90	140-8T/6-5,5	64	76	85	89	87	81	71	68
125-4T/6-100	74	82	98	105	107	102	96	92	140-8T/6-7,5	65	77	86	90	88	82	72	69
125-4T/9-25	66	74	91	97	98	93	88	84	140-8T/6-10	66	78	87	91	89	83	73	70
125-4T/9-30	67	75	92	98	99	94	89	85	140-8T/6-15	68	80	89	93	91	85	75	72
125-4T/9-40	68	76	93	99	100	95	90	86	140-8T/9-4	61	72	83	88	86	82	72	67
125-4T/9-50	70	78	95	101	102	97	92	88	140-8T/9-5,5	62	73	84	89	87	83	73	68
125-4T/9-60	72	80	97	103	104	99	94	90	140-8T/9-7,5	63	74	85	90	88	84	74	69
125-4T/9-75	72	80	97	103	104	99	94	90	140-8T/9-10	64	75	86	91	89	85	75	70
125-4T/9-100	74	82	99	105	106	101	96	92	140-8T/9-15	65	76	87	92	90	86	76	71
125-6T/3-4	64	72	84	88	86	81	72	68	140-8T/9-20	67	78	89	94	92	88	78	73
125-6T/3-5,5	66	74	86	90	88	83	74	70	160-6T/3-5,5	67	77	85	90	89	88	75	70
125-6T/3-7,5	67	75	87	91	89	84	75	71	160-6T/3-7,5	68	78	86	91	90	89	76	71
125-6T/3-10	68	76	88	92	90	85	76	72	160-6T/3-10	69	79	87	92	91	90	77	72
125-6T/3-15	69	77	89	93	91	86	77	73	160-6T/3-15	70	80	88	93	92	91	78	73
125-6T/3-20	71	79	91	95	93	88	79	75	160-6T/3-20	72	82	90	95	94	93	80	75
125-6T/6-5,5	59	68	81	84	85	82	71	67	160-6T/3-25	73	83	91	96	95	94	81	76
125-6T/6-7,5	60	69	82	85	86	83	72	68	160-6T/3-30	74	84	92	97	96	95	82	77
125-6T/6-10	61	70	83	86	87	84	73	69	160-6T/6-10	67	82	91	93	90	84	76	72
125-6T/6-15	63	72	85	88	89	86	75	71	160-6T/6-15	68	83	92	94	91	85	77	73
125-6T/6-20	65	74	87	90	91	88	77	73	160-6T/6-20	70	85	94	96	93	87	79	75
125-6T/6-25	66	75	88	91	92	89	78	74	160-6T/6-25	71	86	95	97	94	88	80	76
125-6T/9-10	57	67	82	86	85	84	73	69	160-6T/6-30	71	86	95	97	94	88	80	76
125-6T/9-15	59	69	84	88	87	86	75	71	160-6T/6-40	72	87	96	98	95	89	81	77
125-6T/9-20	62	72	87	91	90	89	78	74	160-6T/6-50	74	89	98	100	97	91	83	79
125-6T/9-25	64	74	89	93	92	91	80	76	160-6T/9-15	67	85	94	93	92	88	79	74
125-6T/9-30	66	76	91	95	94	93	82	78	160-6T/9-20	68	86	95	94	93	89	80	75
125-8T/3-3	56	63	74	78	77	70	61	57	160-6T/9-25	69	87	96	95	94	90	81	76
125-8T/3-4	59	66	77	81	80	73	64	60	160-6T/9-30	70	88	97	96	95	91	82	77
125-8T/3-5,5	60	67	78	82	81	74	65	61	160-6T/9-40	71	89	98	97	96	92	83	78
125-8T/3-7,5	62	69	80	84	83	76	67	63	160-6T/9-50	72	90	99	98	97	93	84	79
125-8T/6-3	53	61	73	78	77	72	61	57	160-6T/9-60	72	90	99	98	97	93	84	79
125-8T/6-4	54	62	74	79	78	73	62	58	160-6T/9-75	73	91	100	99	98	94	85	80
125-8T/6-5,5	56	64	76	81	80	75	64	60	160-6T/9-100	75	93	102	101	100	96	87	82
125-8T/6-7,5	58	66	78	83	82	77	66	62	160-8T/3-3	61	71	79	84	83	82	69	64
125-8T/6-10	59	67	79	84	83	78	67	63	160-8T/3-4	63	73	81	86	85	84	71	66
125-8T/9-4	51	62	72	78	79	74	63	59	160-8T/3-5,5	64	74	82	87	86	85	72	67
125-8T/9-5,5	53	64	74	80	81	76	65	61	160-8T/3-7,5	65	75	83	88	87	86	73	68
125-8T/9-7,5	56	67	77	83	84	79	68	64	160-8T/3-10	66	76	84	89	88	87	74	69
125-8T/9-10	58	69	79	85	86	81	70	66	160-8T/3-15	68	78	86	91	90	89	76	71
125-8T/9-15	59	70	80	86	87	82	71	67	160-8T/6-4	60	75	84	86	83	77	69	65
140-6T/3-4	66	76	84	89	88	87	74	74	160-8T/6-5,5	61	76	85	87	84	78	70	66
140-6T/3-5,5	69	79	87	92	91	90	77	77	160-8T/6-7,5	62	77	86	88	85	79	71	67
140-6T/3-7,5	69	79	87	92	91	90	77	77	160-8T/6-10	63	78	87	89	86	80	72	68
140-6T/3-10	70	80	88	93	92	91	78	78	160-8T/6-15	65	80	89	91	88	82	74	70
140-6T/3-15	71	81	89	94	93	92	79	79	160-8T/6-20	66	81	90	92	89	83	75	71
140-6T/3-20	73	83	91	96	95	94	81	81	160-8T/6-25	68	83	92	94	91	85	77	73
140-6T/6-5,5	66	81	90	92	89	83	75	71	160-8T/9-7,5	60	78	87	86	85	81	72	67
140-6T/6-7,5	67	82	91	93	90	84	76	72	160-8T/9-10	62	80	89	88	87	83	74	69
140-6T/6-10	68	83	92	94	91	85	77	73	160-8T/9-15	63	81	90	89	88	84	75	70
140-6T/6-15	69	84	93	95	92	86	78	74	160-8T/9-20	64	82	91	90	89	85	76	71
140-6T/6-20	71	86	95	97	94	88	80	76	160-8T/9-25	65	83	92	91	90	86	77	72
140-6T/6-25	72	87	96	98	95	89	81	77	160-8T/9-30	66	84	93	92	91	87	78	73
140-6T/6-30	73	88	97	99	96	90	82	78	160-8T/9-40	68	86	95	94	93	89	80	75

## Dimensiones mm

### HGT

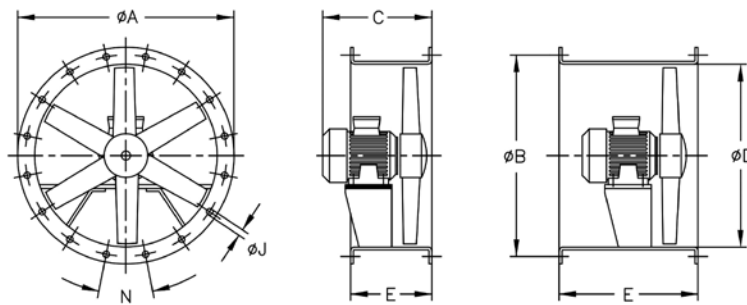

Modelo	ØA	ØB	C (Consultar tamaño constructivo motor)							ØD	E*		ØJ	N
			132	160	180	200	225	250	280		Corta (STD)	larga		
HGT-125	1365	1320	586	-	-	-	-	-	-	1250	500	700	15	20x18°
HGT-125	1365	1320	-	700	-	-	-	-	-	1250	500	700	15	20x18°
HGT-125	1365	1320	-	-	765	825	-	-	-	1250	700	900	15	20x18°
HGT-125	1365	1320	-	-	-	-	910	-	-	1250	700	1000	15	20x18°
HGT-125	1365	1320	-	-	-	-	-	985	-	1250	700	1000	15	20x18°
HGT-125	1365	1320	-	-	-	-	-	-	1190	1250	700	1200	15	20x18°
HGT-140	1515	1470	586	-	-	-	-	-	-	1400	400	650	15	20x18°
HGT-140	1515	1470	-	700	-	-	-	-	-	1400	450	700	15	20x18°
HGT-140	1515	1470	-	-	765	825	-	-	-	1400	550	900	15	20x18°
HGT-140	1515	1470	-	-	-	-	910	-	-	1400	550	1000	15	20x18°
HGT-140	1515	1470	-	-	-	-	-	985	-	1400	600	1000	15	20x18°
HGT-160	1735	1680	586	-	-	-	-	-	-	1600	400	650	19	24x15°
HGT-160	1735	1680	-	700	-	-	-	-	-	1600	450	700	19	24x15°
HGT-160	1735	1680	-	-	765	825	-	-	-	1600	550	900	19	24x15°
HGT-160	1735	1680	-	-	-	-	910	-	-	1600	550	1000	19	24x15°
HGT-160	1735	1680	-	-	-	-	-	985	-	1600	600	1000	19	24x15°
HGT-160	1735	1680	-	-	-	-	-	-	1190	1600	700	1200	19	24x15°

\* Versión estándar suministrada en carcasa corta. Bajo demanda carcasa larga con trampilla de inspección.

### Tamaños constructivos motores según potencia

Polos	r/min	CV	3	4	5,5	7,5	10	15	20	25	30	40	50	60	75	100
4T	1500	-	-	-	-	-	132	160	160	180	180	200	225	225	250	280
6T	1000	-	132	132	132	160	160	180	200	200	225	250	280	280	280	280
8T	750	-	132	132	160	160	160	180	200	225	225	250	-	-	-	-

### HGTX

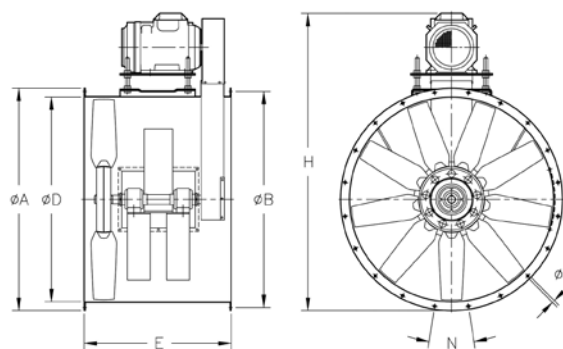

Modelo	ØA	ØB	ØD	E	H (Consultar tamaño constructivo motor)							ØJ	N	
					132	160	180	200	225	250	280			
HGT-X 125	1365	1320	1250	900	1743	1815	1850	-	-	-	-	-	15	20x18°
HGT-X 125	1365	1320	1250	960	-	-	-	1930	1995	-	-	-	15	20x18°
HGT-X 125	1365	1320	1250	1100	-	-	-	-	-	2060	-	-	15	20x18°
HGT-X 125	1365	1320	1250	1100	-	-	-	-	-	-	2090	-	15	20x18°

### Tamaños constructivos motores según potencia

Polos	r/min	CV	3	4	5,5	7,5	10	15	20	25	30	40	50	60	75	100
4T	1500	-	-	-	-	-	132	160	160	180	180	200	225	225	250	280
6T	1000	-	132	132	132	160	160	180	200	200	225	250	280	280	280	280
8T	750	-	132	132	160	160	160	180	200	225	225	250	-	-	-	-

## EJEMPLO SELECCIÓN

### Curvas características

Q= Caudal en m<sup>3</sup>/h, m<sup>3</sup>/s y cfm.

Pe= Presión estática en mmH<sub>2</sub>O, Pa e inwg.

**Diámetro Hélice (cm): 125**

**Número de polos: 8**

**Número de palas: 3**

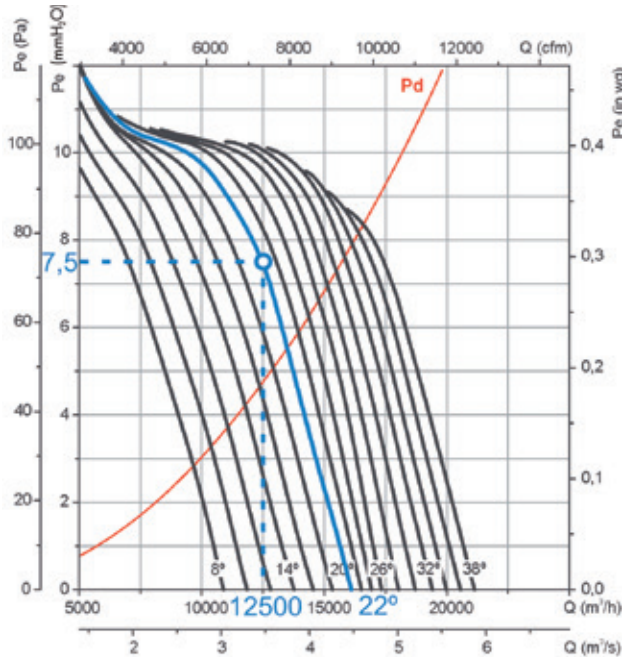

#### Datos de partida

- Punto de trabajo:
- Caudal: 12.500 m<sup>3</sup>/h
- Pérdida de carga: 7,5 mmH<sub>2</sub>O

#### Pasos para la selección del equipo

##### En la gráfica de presiones:

1. Marcar el punto de trabajo, definido por el caudal de trabajo (12.500 m<sup>3</sup>/h) y la pérdida de carga (7,5 mmH<sub>2</sub>O).
2. Escoger la curva del equipo que más se acerque por encima al punto de trabajo. En nuestro caso se obtiene una curva de 22° de ángulo de pala.

##### En la gráfica de potencia:

3. Marcar el punto de trabajo, definido por el caudal de trabajo (12.500 m<sup>3</sup>/h) y la curva de ángulo de pala escogido (22°).
4. Leer la potencia absorbida en el eje de potencias a la izquierda. La Pa= 560 W en el punto de trabajo.
5. Buscar recta roja que más se acerque al punto de trabajo por encima. En la parte derecha de la gráfica se obtiene el valor de potencia instalada de motor. En nuestro caso 0,75 kW o 1 CV

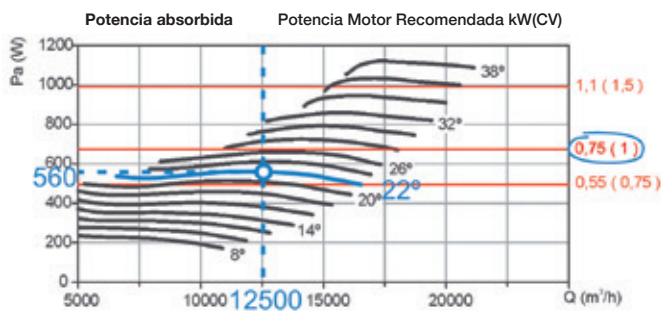

## EJEMPLO CÓDIGO PEDIDO

**HGT — 125 — 8T — 3 — 1 — 22**

HGT: Ventiladores helicoidales tubulares de gran diámetro, con motor directo  
 HGTX: Ventiladores helicoidales tubulares de gran diámetro, con motor exterior

Diámetro hélice en cm

Número de polos motor  
 4=1400 r/min. 50 Hz  
 6=900 r/min. 50 Hz  
 8=750 r/min. 50 Hz

T=Trifásico

Número de palas  
 3 palas  
 6 palas  
 9 palas

Potencia motor (CV)

Angulo inclinación palas

**Curvas características**

Q= Caudal en m<sup>3</sup>/h, m<sup>3</sup>/s y cfm.

Pe= Presión estática en mmH<sub>2</sub>O, Pa e inwg.

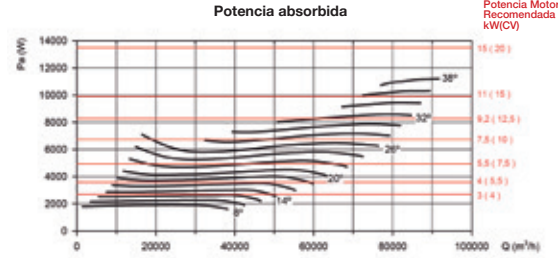
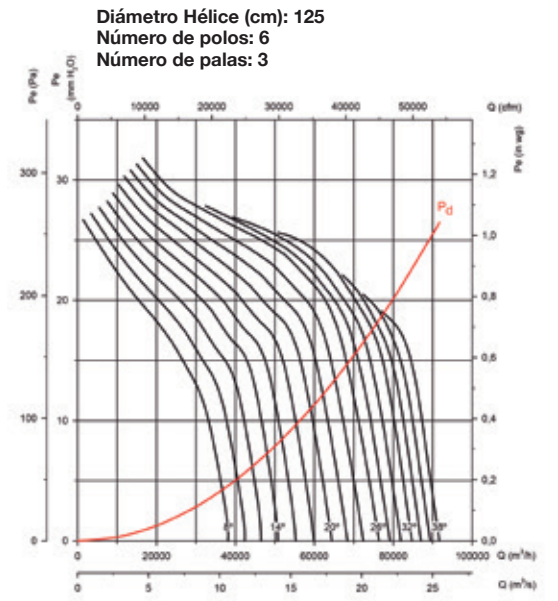
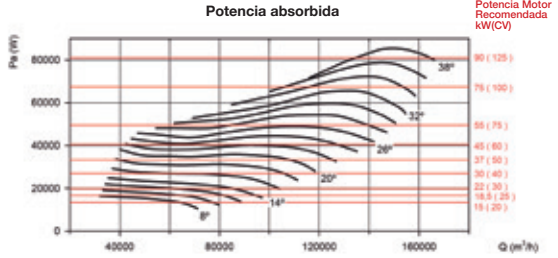
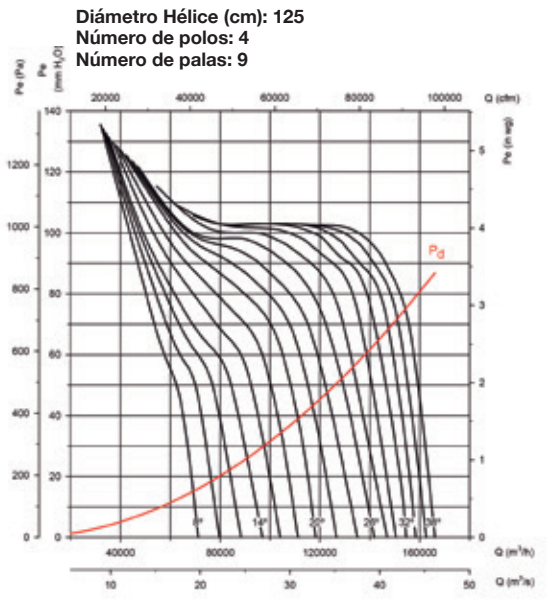
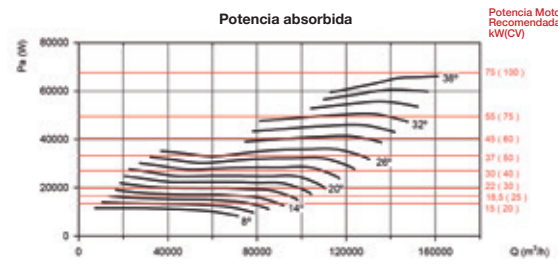
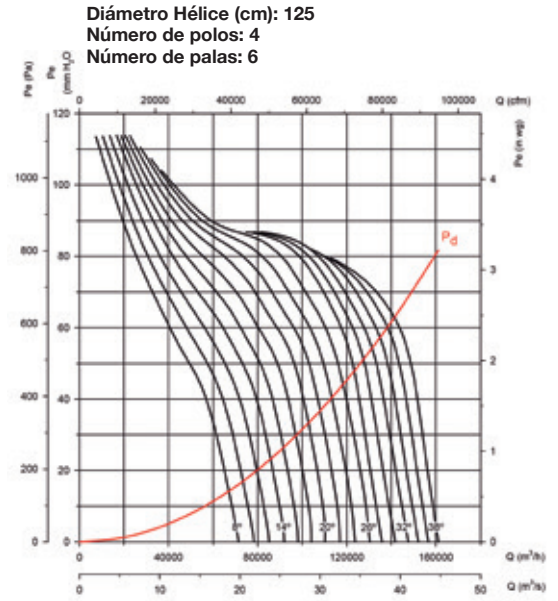
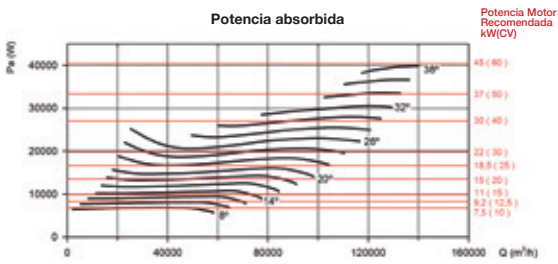
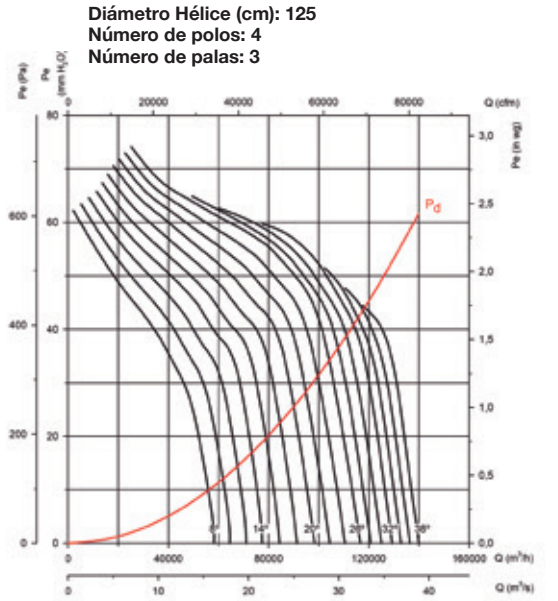

Curvas características

Q= Caudal en m<sup>3</sup>/h, m<sup>3</sup>/s y cfm.

Pe= Presión estática en mmH<sub>2</sub>O, Pa e inwg.

Diámetro Hélice (cm): 125  
Número de polos: 6  
Número de palas: 6

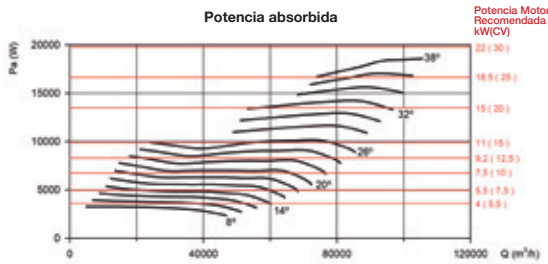
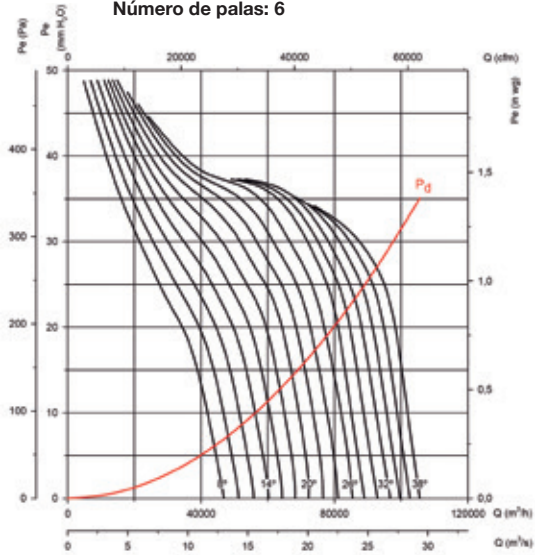

Diámetro Hélice (cm): 125  
Número de polos: 6  
Número de palas: 9

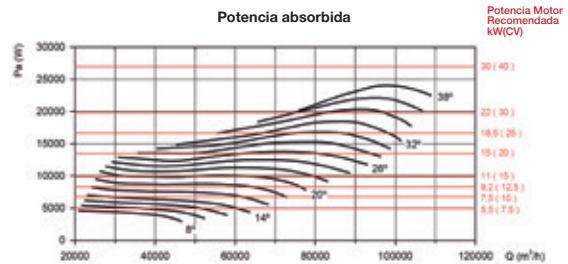
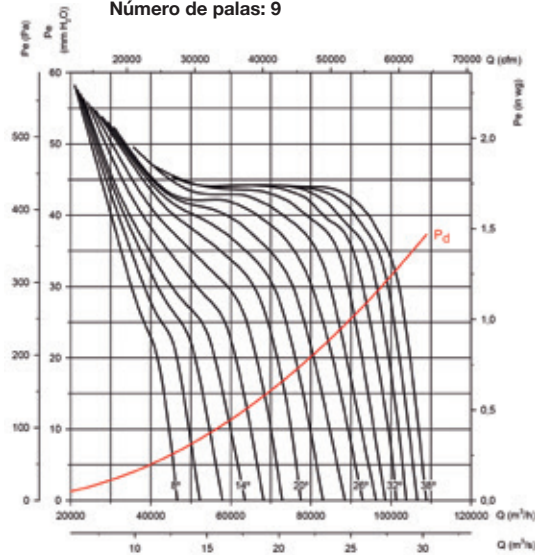

Diámetro Hélice (cm): 125  
Número de polos: 8  
Número de palas: 3

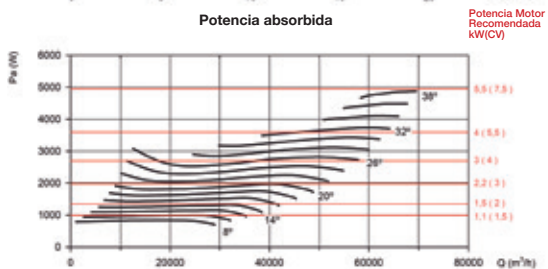
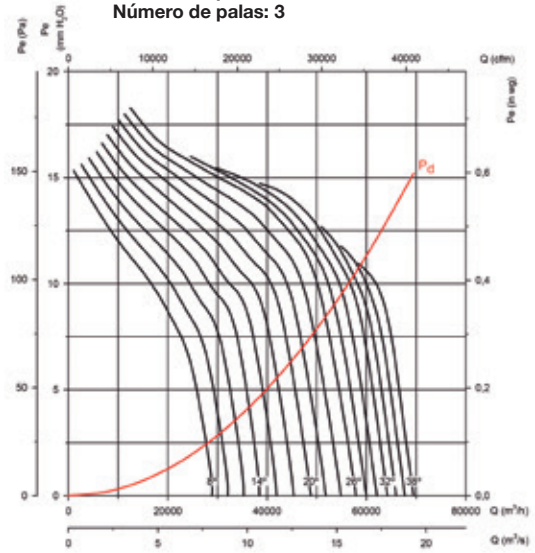

Diámetro Hélice (cm): 125  
Número de polos: 8  
Número de palas: 6

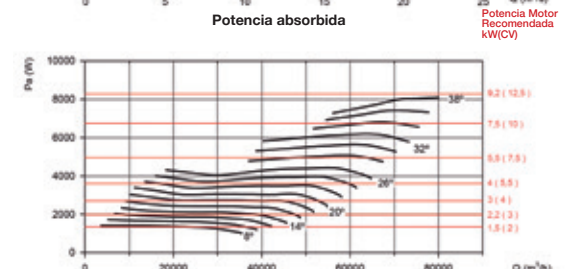
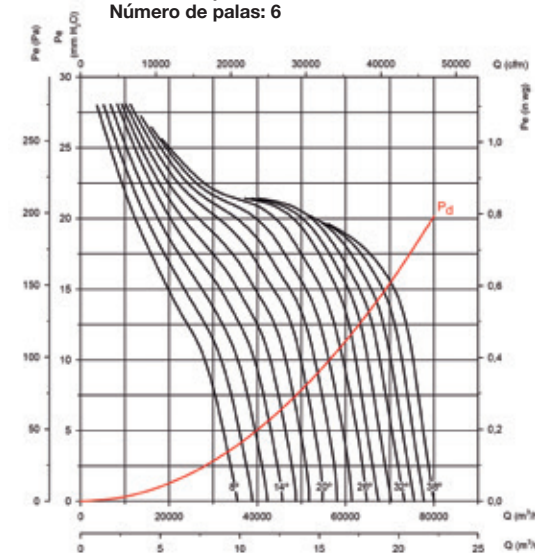



**Curvas características**

Q= Caudal en m<sup>3</sup>/h, m<sup>3</sup>/s y cfm.

Pe= Presión estática en mmH<sub>2</sub>O, Pa e inwg.

**Diámetro Hélice (cm): 125**  
**Número de polos: 8**  
**Número de palas: 9**

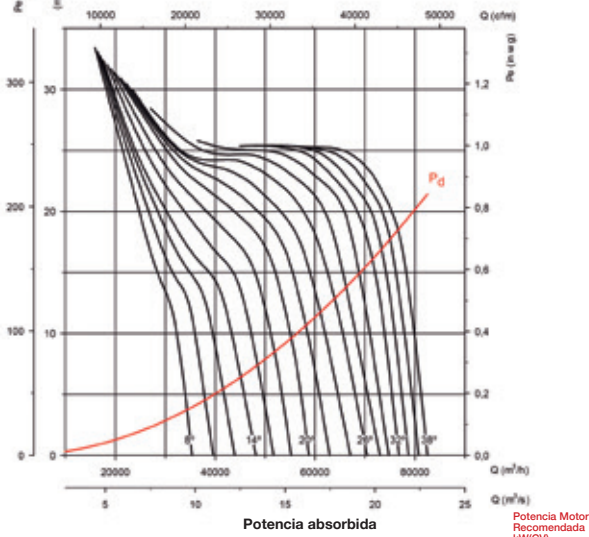

**Diámetro Hélice (cm): 140**  
**Número de polos: 6**  
**Número de palas: 3**

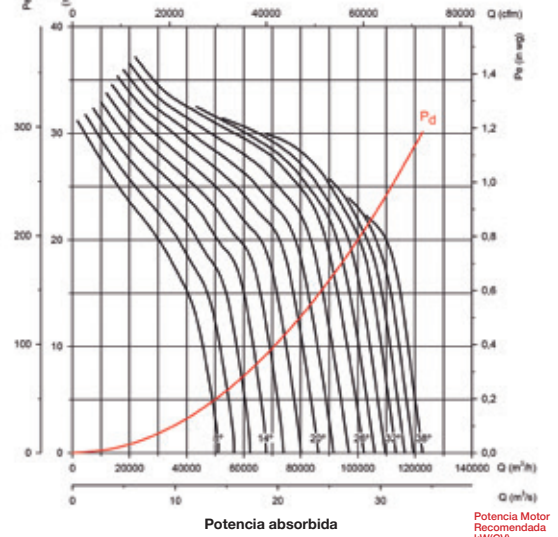

**Diámetro Hélice (cm): 140**  
**Número de polos: 6**  
**Número de palas: 6**

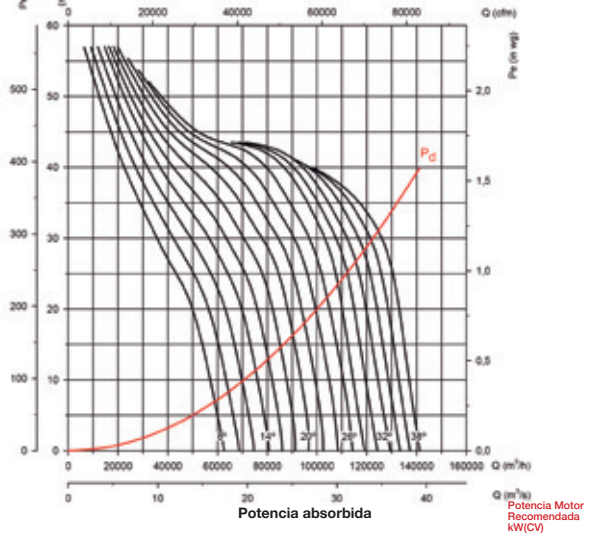

**Diámetro Hélice (cm): 140**  
**Número de polos: 6**  
**Número de palas: 9**

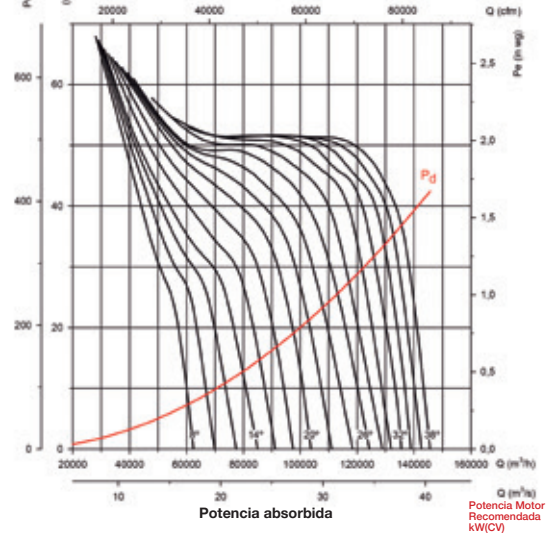

Curvas características

Q= Caudal en m<sup>3</sup>/h, m<sup>3</sup>/s y cfm.

Pe= Presión estática en mmH<sub>2</sub>O, Pa e inwg.

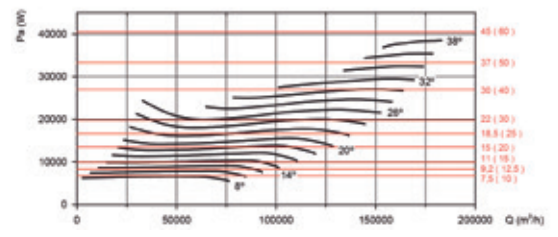
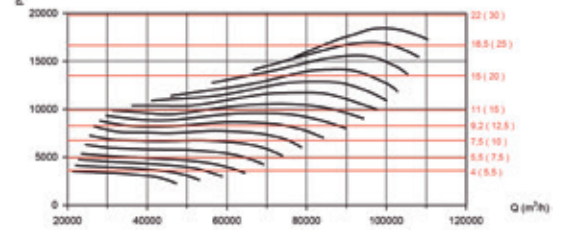
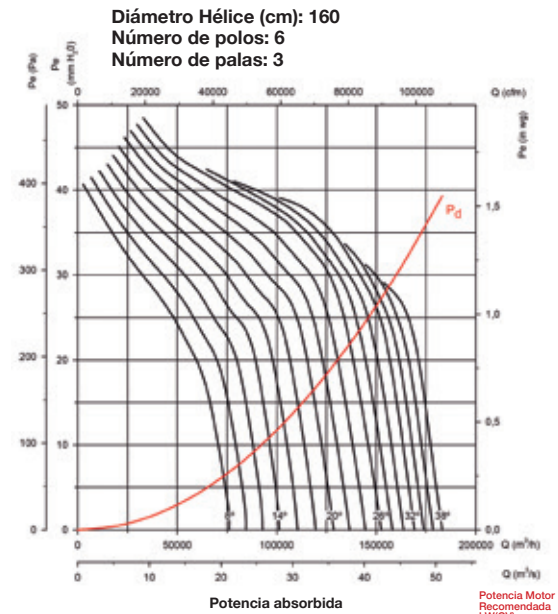
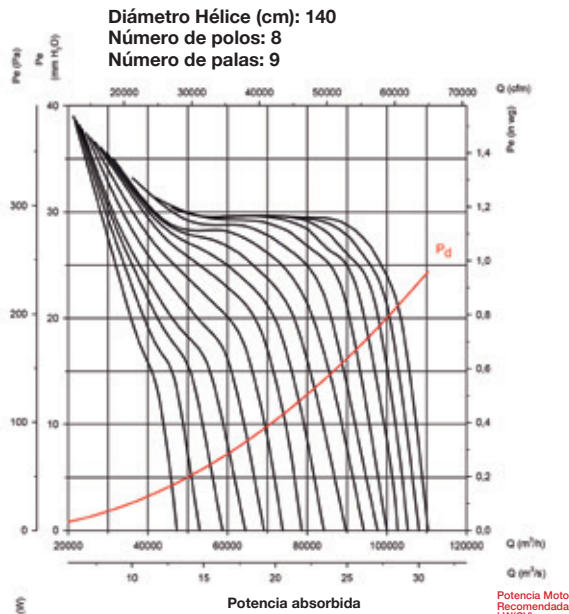
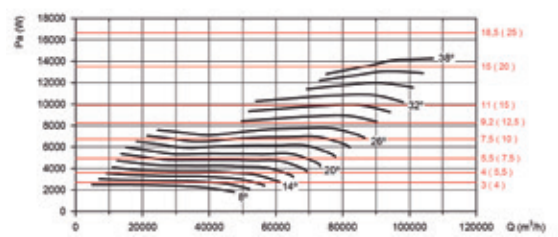
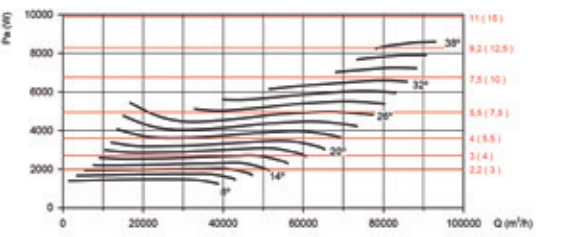
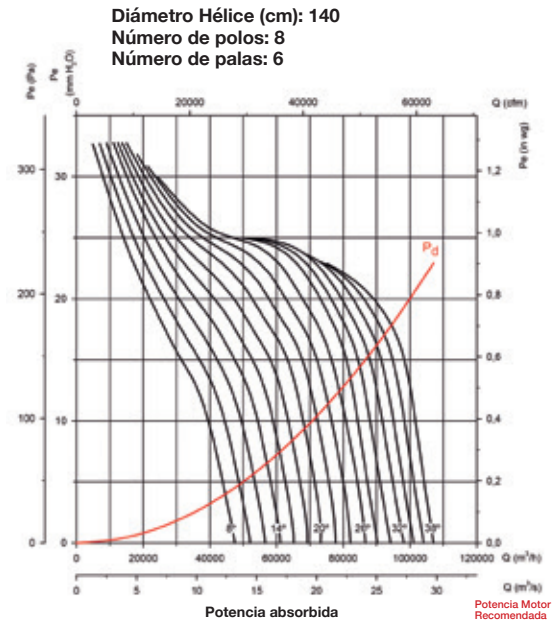
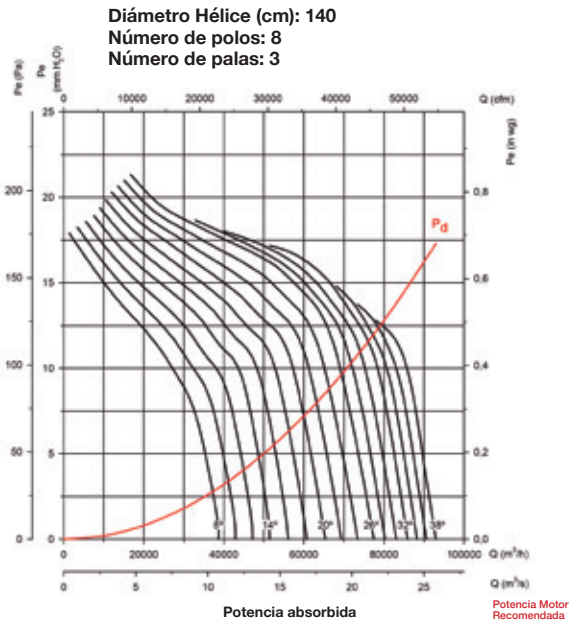

Curvas características

Q= Caudal en m<sup>3</sup>/h, m<sup>3</sup>/s y cfm.

Pe= Presión estática en mmH<sub>2</sub>O, Pa e inwg.

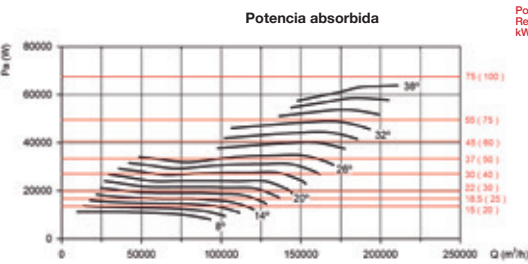
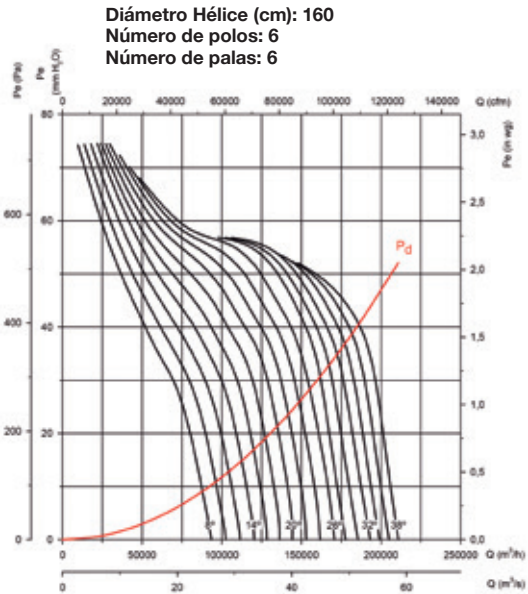

Potencia Motor Recomendada kW(CV)

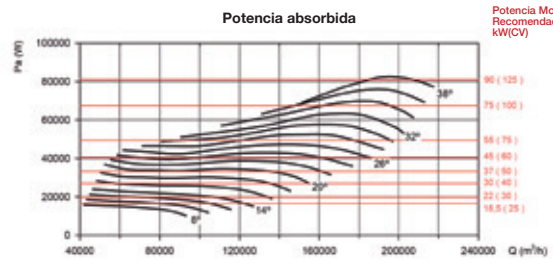
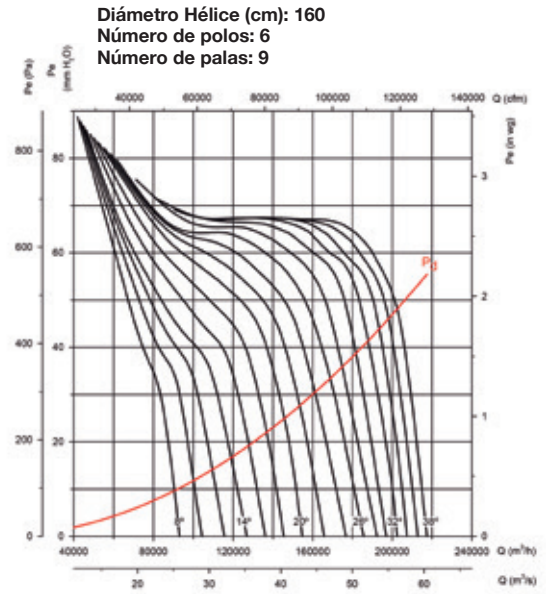

Potencia Motor Recomendada kW(CV)

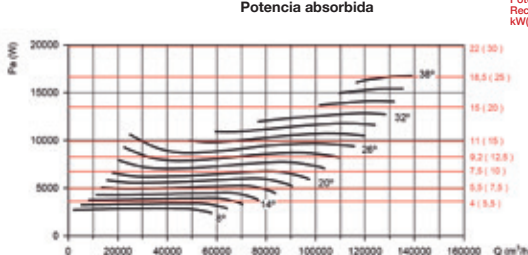
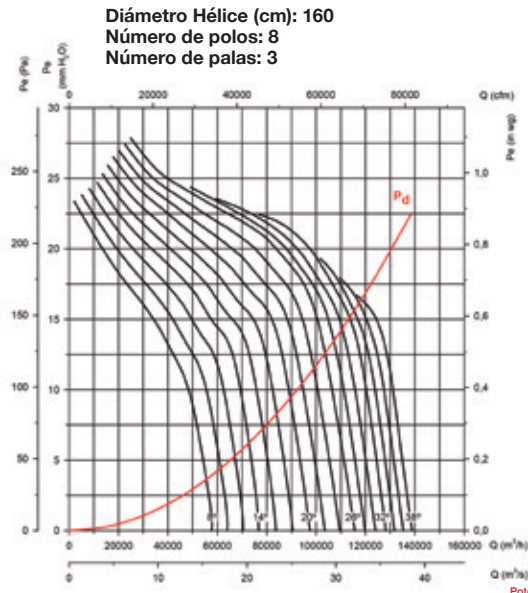

Potencia Motor Recomendada kW(CV)

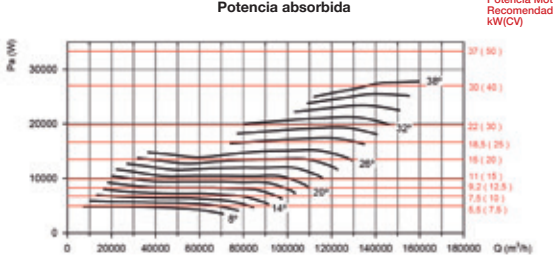
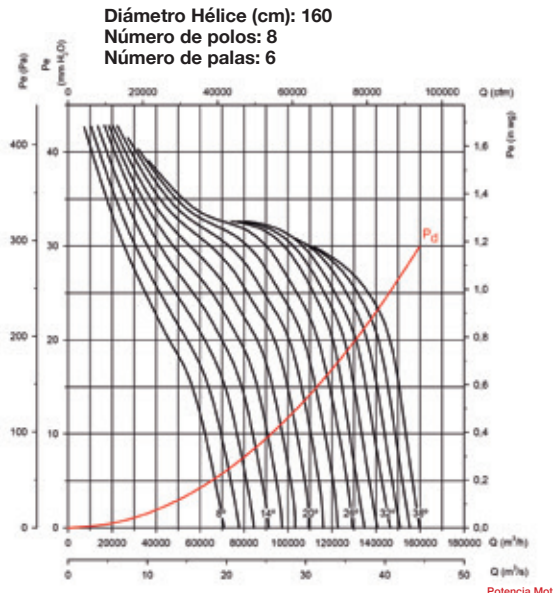

Potencia Motor Recomendada kW(CV)

**Curvas características**

Q= Caudal en m<sup>3</sup>/h, m<sup>3</sup>/s y cfm. Pe= Presión estática en mmH<sub>2</sub>O, Pa e inwg.

**Diámetro Hélice (cm): 160**  
**Número de polos: 8**  
**Número de palas: 9**

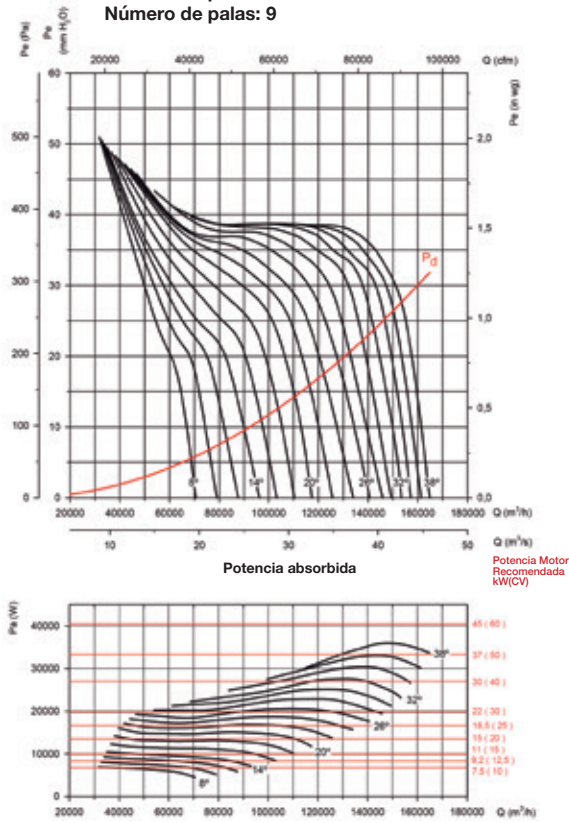

**Accesorios**

Ver apartado accesorios.





**Erp. Características del punto de máxima eficiencia (BEP)**

α [°]	Ángulo inclinación palas en grados	SR	Relación específica
PN	Potencia nominal motor en kW	ηe[%]	Eficiencia
MC	Categoría de medición	N	Grado de eficiencia
EC	Categoría de eficiencia	[kW]	Potencia eléctrica
S	Estática	[m³/h]	Caudal
T	Total	[mmH <sub>2</sub> O]	Presión estática o total (Según EC)
VSD	Variador de velocidad	[RPM]	Velocidad

**HGT-125-4T/3**

α [°]	PN	MC	EC	VSD	SR	ηe [%]	N	[kW]	[m³/h]	[mmH <sub>2</sub> O]	[RPM]
8	7,5	C	S	NO	1,00	52,5%	53,3	7,557	41511	35,13	1468
10	11	C	S	NO	1,00	53,7%	54,0	8,917	46792	37,56	1478
12	11	C	S	NO	1,00	54,8%	54,8	10,351	52185	39,90	1474
14	15	C	S	NO	1,01	56,7%	56,7	11,671	57655	42,19	1475
16	15	C	S	NO	1,01	56,1%	55,9	13,387	62205	44,33	1471
18	15	C	S	NO	1,01	55,4%	55,2	15,230	67316	46,06	1467
20	18,5	C	S	NO	1,01	55,1%	54,8	17,092	72427	47,79	1474
22	18,5	C	S	NO	1,01	52,9%	52,4	19,727	77315	49,54	1470
24	22	C	S	NO	1,01	51,6%	51,1	21,959	82218	50,63	1472
26	30	C	S	NO	1,01	52,2%	51,6	24,002	84773	54,27	1485
28	30	C	S	NO	1,01	48,9%	48,3	26,507	90252	52,81	1483
30	30	C	S	NO	1,01	47,0%	46,2	29,132	94744	53,05	1482
32	37	C	S	NO	1,01	45,2%	44,4	31,679	99128	53,03	1484
34	37	B	T	NO	1,01	75,3%	74,4	35,348	116210	84,11	1482
36	37	B	T	NO	1,01	73,7%	72,7	38,587	121252	86,13	1480
38	45	B	T	NO	1,01	73,0%	72,0	41,710	125686	89,03	1478

**HGT-125-4T/6**

α [°]	PN	MC	EC	VSD	SR	ηe [%]	N	[kW]	[m³/h]	[mmH <sub>2</sub> O]	[RPM]
8	15	C	S	NO	1,01	58,5%	58,5	11,665	48508	51,71	1475
10	15	C	S	NO	1,01	57,2%	57,0	14,131	52757	56,25	1470
12	18,5	C	S	NO	1,01	57,3%	57,0	16,358	58230	59,12	1475
14	18,5	C	S	NO	1,01	57,9%	57,5	18,563	63848	61,84	1472
16	22	C	S	NO	1,01	57,5%	57,0	21,282	68837	65,30	1473
18	30	C	S	NO	1,01	57,3%	56,7	23,851	77896	64,43	1485
20	30	C	S	NO	1,01	57,5%	56,8	26,765	80997	69,77	1483
22	37	C	S	NO	1,01	55,6%	54,8	30,364	85910	72,17	1485
24	37	C	S	NO	1,01	54,5%	53,6	34,129	88480	77,19	1483
26	37	C	S	NO	1,01	52,9%	51,9	38,194	93638	79,23	1481
28	45	C	S	NO	1,01	50,1%	49,0	43,550	102038	78,56	1477
30	55	C	S	NO	1,01	47,4%	46,2	48,074	106474	78,56	1483
32	55	C	S	NO	1,01	44,9%	43,7	52,829	110911	78,56	1482
34	75	B	T	NO	1,01	71,5%	70,2	58,224	131496	116,23	1489
36	75	B	T	NO	1,01	71,0%	69,6	63,318	136742	120,78	1488
38	75	B	T	NO	1,01	71,1%	69,7	68,226	142272	125,19	1487

**HGT-125-4T/9**

α [°]	PN	MC	EC	VSD	SR	ηe [%]	N	[kW]	[m³/h]	[mmH <sub>2</sub> O]	[RPM]
8	18,5	C	S	NO	1,01	70,2%	69,9	17,484	37304	120,90	1474
10	18,5	C	S	NO	1,01	62,1%	61,7	20,303	41359	112,05	1470
12	22	C	S	NO	1,01	58,6%	58,0	21,967	50452	93,68	1472
14	22	C	S	NO	1,01	56,8%	56,2	23,247	73859	65,67	1471
16	30	C	S	NO	1,01	54,3%	53,6	27,953	80439	69,38	1483
18	37	C	S	NO	1,01	53,0%	52,2	32,923	87528	73,29	1483
20	37	C	S	NO	1,01	52,5%	51,6	37,906	94456	77,46	1481
22	45	C	S	NO	1,01	51,2%	50,1	42,697	97688	82,16	1478
24	45	C	S	NO	1,01	50,6%	49,5	47,300	101406	86,68	1475
26	55	C	S	NO	1,01	51,3%	50,1	51,728	106241	91,67	1482
28	55	C	S	NO	1,01	49,9%	48,7	57,471	112236	93,94	1480
30	75	C	S	NO	1,01	49,8%	48,5	62,909	120361	95,67	1488
32	75	C	S	NO	1,01	48,8%	47,3	68,406	125253	97,81	1487
34	75	B	T	NO	1,01	75,0%	73,5	75,659	140724	148,06	1486
36	90	B	T	NO	1,01	73,4%	71,8	81,920	145177	152,12	1487
38	90	B	T	NO	1,02	71,2%	69,6	89,259	149120	156,66	1486



### Erp. Características del punto de máxima eficiencia (BEP)

#### HGT-125-6T/3

Δ [°]	PN	MC	EC	VSD	SR	ηe [%]	N	[kW]	[m³/h]	[mmH₂O]	[RPM]
8	2,2	C	S	NO	1,00	48,6%	52,7	2,295	27197	15,08	961
10	3	C	S	NO	1,00	49,2%	52,8	2,735	30657	16,12	969
12	3	C	S	NO	1,00	50,2%	53,4	3,175	34190	17,13	964
14	3	C	S	NO	1,00	51,5%	54,3	3,615	37774	18,11	960
16	4	C	S	NO	1,00	51,5%	54,0	4,097	40755	19,03	965
18	4	C	S	NO	1,00	50,9%	53,0	4,661	44104	19,77	960
20	5,5	C	S	NO	1,00	51,9%	53,8	5,105	47452	20,51	980
22	5,5	C	S	NO	1,00	49,8%	51,2	5,892	50654	21,27	977
24	7,5	C	S	NO	1,00	50,4%	51,6	6,394	53010	22,32	981
26	7,5	C	S	NO	1,00	49,6%	50,6	7,121	56526	22,97	979
28	7,5	C	S	NO	1,00	46,9%	47,6	7,859	59317	22,84	977
30	11	C	S	NO	1,00	45,1%	45,6	8,528	62074	22,77	982
32	11	C	S	NO	1,00	43,4%	43,7	9,263	64946	22,76	981
34	11	B	T	NO	1,00	72,4%	72,5	10,336	76138	36,11	979
36	11	B	T	NO	1,00	70,9%	70,9	11,283	79441	36,97	977
38	15	B	T	NO	1,00	70,2%	70,2	12,198	82346	38,21	981

#### HGT-125-6T/6

Δ [°]	PN	MC	EC	VSD	SR	ηe [%]	N	[kW]	[m³/h]	[mmH₂O]	[RPM]
8	4	C	S	NO	1,00	53,8%	56,6	3,570	31781	22,20	970
10	4	C	S	NO	1,00	52,5%	54,8	4,325	34565	24,14	963
12	5,5	C	S	NO	1,00	53,9%	55,9	4,886	38151	25,38	981
14	5,5	C	S	NO	1,00	54,5%	56,2	5,544	41832	26,55	978
16	7,5	C	S	NO	1,00	55,4%	56,7	6,217	45100	28,03	982
18	7,5	C	S	NO	1,00	54,6%	55,6	7,035	51036	27,66	979
20	7,5	C	S	NO	1,00	54,8%	55,5	7,895	53067	29,95	977
22	11	C	S	NO	1,00	53,5%	53,8	8,879	56286	30,98	982
24	11	C	S	NO	1,00	52,0%	52,1	10,043	57719	33,26	979
26	11	C	S	NO	1,00	50,9%	50,9	11,168	61349	34,01	977
28	15	C	S	NO	1,00	48,2%	48,1	12,737	66852	33,72	981
30	15	C	S	NO	1,00	45,3%	45,1	14,134	69759	33,72	979
32	15	C	S	NO	1,00	42,9%	42,7	15,532	72666	33,72	976
34	18,5	B	T	NO	1,00	67,1%	66,8	17,425	86152	49,89	983
36	18,5	B	T	NO	1,01	66,7%	66,3	18,950	89589	51,84	981
38	18,5	B	T	NO	1,01	66,8%	66,3	20,418	93213	53,74	980

#### HGT-125-6T/9

Δ [°]	PN	MC	EC	VSD	SR	ηe [%]	N	[kW]	[m³/h]	[mmH₂O]	[RPM]
8	5,5	C	S	NO	1,01	66,1%	67,9	5,222	24441	51,89	979
10	7,5	C	S	NO	1,00	60,5%	61,9	5,867	27097	48,10	983
12	7,5	C	S	NO	1,00	56,4%	57,6	6,417	33055	40,21	981
14	7,5	C	S	NO	1,00	54,7%	55,8	6,791	48390	28,19	980
16	7,5	C	S	NO	1,00	51,8%	52,4	8,245	52702	29,78	976
18	11	C	S	NO	1,00	51,0%	51,1	9,627	57346	31,46	980
20	11	C	S	NO	1,00	50,5%	50,5	11,084	61885	33,25	977
22	15	C	S	NO	1,00	49,2%	49,1	12,487	64003	35,27	981
24	15	C	S	NO	1,00	49,0%	48,8	13,824	65542	37,94	979
26	15	C	S	NO	1,01	49,0%	48,8	15,209	69606	39,35	977
28	18,5	C	S	NO	1,01	47,2%	46,8	17,109	73534	40,32	983
30	18,5	C	S	NO	1,01	46,8%	46,4	18,827	78857	41,07	981
32	18,5	C	S	NO	1,01	45,8%	45,3	20,472	82062	41,98	980
34	22	B	T	NO	1,01	71,0%	70,5	22,466	92199	63,56	981
36	22	B	T	NO	1,01	69,1%	68,5	24,454	95116	65,30	980
38	30	B	T	NO	1,01	68,3%	67,6	26,205	97699	67,25	988



### Erp. Características del punto de máxima eficiencia (BEP)

#### HGT-125-8T/3

α [°]	PN	MC	EC	VSD	SR	ηe [%]	N	[kW]	[m³/h]	[mmH₂O]	[RPM]
8	1,1	C	S	NO	1,00	42,3%	48,2	1,150	20612	8,66	716
10	1,5	C	S	NO	1,00	44,2%	49,8	1,325	23235	9,26	720
12	1,5	C	S	NO	1,00	45,1%	50,3	1,538	25912	9,84	715
14	1,5	C	S	NO	1,00	46,3%	51,1	1,751	28629	10,40	710
16	2,2	C	S	NO	1,00	45,8%	50,2	2,008	30888	10,93	719
18	2,2	C	S	NO	1,00	45,2%	49,3	2,285	33426	11,36	715
20	2,2	C	S	NO	1,00	45,0%	48,8	2,561	35964	11,78	710
22	2,2	C	S	NO	1,00	43,2%	46,6	2,955	38311	12,24	704
24	3	C	S	NO	1,00	44,3%	47,5	3,175	38268	13,50	713
26	3	C	S	NO	1,00	43,2%	46,0	3,553	42094	13,38	708
28	4	C	S	NO	1,00	41,5%	44,2	3,859	44508	13,23	719
30	4	C	S	NO	1,00	39,6%	42,0	4,229	46875	13,12	716
32	4	C	S	NO	1,00	38,0%	40,2	4,607	49222	13,07	713
34	4	B	T	NO	1,00	63,4%	65,2	5,141	57704	20,74	709
36	5,5	B	T	NO	1,00	66,9%	68,7	5,205	60208	21,24	730
38	5,5	B	T	NO	1,00	66,4%	68,0	5,620	62409	21,95	728

#### HGT-125-8T/6

α [°]	PN	MC	EC	VSD	SR	ηe [%]	N	[kW]	[m³/h]	[mmH₂O]	[RPM]
8	1,5	C	S	NO	1,00	47,8%	52,6	1,750	24087	12,75	710
10	2,2	C	S	NO	1,00	46,7%	50,9	2,120	26197	13,87	717
12	2,2	C	S	NO	1,00	46,8%	50,7	2,451	28914	14,58	712
14	3	C	S	NO	1,00	48,9%	52,5	2,692	31704	15,25	719
16	3	C	S	NO	1,00	48,0%	51,2	3,120	34181	16,10	713
18	3	C	S	NO	1,00	47,4%	50,3	3,531	38680	15,89	709
20	4	C	S	NO	1,00	48,3%	50,9	3,897	40219	17,20	719
22	4	C	S	NO	1,00	46,8%	49,1	4,416	42659	17,80	715
24	5,5	C	S	NO	1,00	48,4%	50,5	4,664	45625	18,18	732
26	5,5	C	S	NO	1,00	48,0%	49,8	5,152	46496	19,54	730
28	5,5	C	S	NO	1,00	45,5%	47,0	5,868	50667	19,37	727
30	7,5	C	S	NO	1,00	43,6%	44,8	6,400	52870	19,37	731
32	7,5	C	S	NO	1,00	41,3%	42,3	7,033	55073	19,37	730
34	7,5	B	T	NO	1,00	65,4%	66,1	7,792	65294	28,66	727
36	11	B	T	NO	1,00	65,7%	66,2	8,378	67899	29,78	733
38	11	B	T	NO	1,00	65,8%	66,1	9,027	70645	30,87	732

#### HGT-125-8T/9

α [°]	PN	MC	EC	VSD	SR	ηe [%]	N	[kW]	[m³/h]	[mmH₂O]	[RPM]
8	2,2	C	S	NO	1,00	57,4%	61,1	2,620	18524	29,81	710
10	3	C	S	NO	1,00	52,5%	55,8	2,945	20537	27,63	716
12	3	C	S	NO	1,00	48,9%	52,0	3,221	25052	23,10	712
14	3	C	S	NO	1,00	47,4%	50,4	3,408	36675	16,19	710
16	4	C	S	NO	1,00	45,7%	48,2	4,070	39942	17,11	718
18	4	C	S	NO	1,00	44,6%	46,7	4,788	43462	18,07	712
20	5,5	C	S	NO	1,00	47,7%	49,5	5,113	46902	19,10	730
22	5,5	C	S	NO	1,00	46,5%	48,0	5,753	48507	20,26	728
24	7,5	C	S	NO	1,00	47,1%	48,4	6,259	49674	21,79	732
26	7,5	C	S	NO	1,00	47,1%	48,2	6,886	52754	22,60	730
28	7,5	C	S	NO	1,00	45,9%	46,7	7,651	55731	23,16	728
30	11	C	S	NO	1,00	46,0%	46,5	8,324	59770	23,52	733
32	11	C	S	NO	1,00	45,1%	45,4	9,051	62194	24,12	732
34	11	B	T	NO	1,00	69,4%	69,5	10,011	69877	36,51	730
36	11	B	T	NO	1,00	67,6%	67,6	10,896	72088	37,51	728
38	15	B	T	NO	1,00	67,1%	67,0	11,609	74046	38,63	733

**Erp. Características del punto de máxima eficiencia (BEP)**
**HGT-140-6T/3**

α [°]	PN	MC	EC	VSD	SR	ηe [%]	N	[kW]	[m³/h]	[mmH₂O]	[RPM]
8	4	C	S	NO	1,00	43,6%	46,1	3,997	36390	17,60	966
10	5,5	C	S	NO	1,00	45,1%	47,3	4,654	41020	18,81	982
12	5,5	C	S	NO	1,00	46,1%	47,8	5,402	45747	19,99	979
14	5,5	C	S	NO	1,00	47,3%	48,6	6,151	50542	21,13	976
16	7,5	C	S	NO	1,00	48,3%	49,4	6,826	54531	22,20	980
18	7,5	C	S	NO	1,00	47,7%	48,4	7,766	59012	23,07	977
20	11	C	S	NO	1,00	47,9%	48,3	8,639	63492	23,94	982
22	11	C	S	NO	1,00	45,2%	45,2	9,978	68187	24,30	980
24	11	C	S	NO	1,00	44,4%	44,4	11,188	71105	25,65	977
26	15	C	S	NO	1,00	43,9%	43,8	12,396	74264	26,91	981
28	15	C	S	NO	1,00	41,6%	41,4	13,667	77986	26,76	979
30	15	B	T	NO	1,00	65,7%	65,5	15,313	94783	39,00	977
32	15	B	T	NO	1,00	65,9%	65,6	16,576	99158	40,47	975
34	18,5	B	T	NO	1,00	62,5%	62,1	18,463	101655	41,68	982
36	22	B	T	NO	1,00	61,6%	61,1	19,997	106107	42,63	983
38	22	B	T	NO	1,00	61,1%	60,6	21,591	110043	44,01	982

**HGT-140-6T/6**

α [°]	PN	MC	EC	VSD	SR	ηe [%]	N	[kW]	[m³/h]	[mmH₂O]	[RPM]
8	5,5	C	S	NO	1,00	48,8%	50,1	6,147	42524	25,90	976
10	7,5	C	S	NO	1,00	49,2%	50,1	7,205	46249	28,17	979
12	7,5	C	S	NO	1,00	49,4%	49,9	8,331	51047	29,61	975
14	11	C	S	NO	1,00	50,3%	50,5	9,382	55972	30,98	981
16	11	C	S	NO	1,00	49,4%	49,4	10,874	60345	32,71	978
18	15	C	S	NO	1,00	48,7%	48,6	12,321	68287	32,27	981
20	15	C	S	NO	1,00	48,9%	48,7	13,826	71005	34,95	979
22	15	C	S	NO	1,00	47,3%	47,0	15,667	75312	36,15	976
24	18,5	C	S	NO	1,00	44,8%	44,5	18,064	80549	36,94	982
26	18,5	C	S	NO	1,01	44,0%	43,5	20,023	84172	38,41	980
28	22	C	S	NO	1,01	42,5%	41,9	22,550	89450	39,35	981
30	30	B	T	NO	1,01	62,3%	61,6	24,853	105037	54,13	988
32	30	B	T	NO	1,01	61,1%	60,4	27,311	110368	55,55	987
34	37	B	T	NO	1,01	60,6%	59,8	29,798	114996	57,67	989
36	37	B	T	NO	1,01	60,2%	59,3	32,399	119625	59,87	988
38	37	B	T	NO	1,01	60,2%	59,3	34,907	124508	61,99	987

**HGT-140-6T/9**

α [°]	PN	MC	EC	VSD	SR	ηe [%]	N	[kW]	[m³/h]	[mmH₂O]	[RPM]
8	11	C	S	NO	1,01	61,0%	61,4	8,837	32703	60,56	982
10	11	C	S	NO	1,01	54,0%	54,0	10,262	36257	56,12	979
12	11	C	S	NO	1,00	50,3%	50,3	11,224	44228	46,93	977
14	11	C	S	NO	1,00	48,8%	48,8	11,878	64747	32,90	976
16	15	C	S	NO	1,00	46,2%	46,0	14,439	70516	34,75	978
18	18,5	C	S	NO	1,00	44,6%	44,2	17,201	76730	36,71	983
20	18,5	C	S	NO	1,01	44,2%	43,7	19,804	82804	38,80	980
22	22	C	S	NO	1,01	43,4%	42,9	22,108	85637	41,15	981
24	22	C	S	NO	1,01	42,9%	42,3	24,492	88897	43,42	979
26	30	C	S	NO	1,01	44,0%	43,3	26,483	93135	45,91	988
28	30	C	S	NO	1,01	43,4%	42,6	29,465	100645	46,65	986
30	30	B	T	NO	1,01	65,7%	64,9	31,785	116137	66,06	985
32	37	B	T	NO	1,01	65,3%	64,4	35,070	119380	70,46	987
34	37	B	T	NO	1,01	63,6%	62,7	38,731	123186	73,50	985
36	45	B	T	NO	1,01	62,6%	61,5	41,746	127100	75,48	987
38	55	B	T	NO	1,01	61,0%	59,9	45,235	130545	77,70	988





### Erp. Características del punto de máxima eficiencia (BEP)

#### HGT-140-8T/3

α [°]	PN	MC	EC	VSD	SR	ηe [%]	N	[kW]	[m³/h]	[mmH₂O]	[RPM]
8	2,2	C	S	NO	1,00	38,7%	43,2	1,959	27580	10,11	720
10	2,2	C	S	NO	1,00	39,2%	43,2	2,334	31089	10,81	714
12	2,2	C	S	NO	1,00	40,0%	43,6	2,710	34671	11,48	708
14	3	C	S	NO	1,00	42,4%	45,7	2,987	38306	12,14	715
16	3	C	S	NO	1,00	41,9%	44,8	3,426	41329	12,75	710
18	4	C	S	NO	1,00	42,1%	44,7	3,833	44725	13,25	720
20	4	C	S	NO	1,00	41,9%	44,2	4,297	48120	13,75	716
22	4	C	S	NO	1,00	40,2%	42,1	4,958	51261	14,28	711
24	5,5	C	S	NO	1,00	42,4%	44,3	5,159	53756	14,96	730
26	5,5	C	S	NO	1,00	41,9%	43,5	5,712	56323	15,62	728
28	5,5	C	S	NO	1,00	39,7%	40,9	6,308	59552	15,43	725
30	7,5	B	T	NO	1,00	63,2%	64,2	6,934	71836	22,40	730
32	7,5	B	T	NO	1,00	63,4%	64,2	7,505	75151	23,24	728
34	11	B	T	NO	1,00	61,5%	62,1	8,163	77044	23,94	734
36	11	B	T	NO	1,00	60,2%	60,5	8,910	80418	24,49	732
38	11	B	T	NO	1,00	59,7%	59,8	9,620	83401	25,28	731

#### HGT-140-8T/6

α [°]	PN	MC	EC	VSD	SR	ηe [%]	N	[kW]	[m³/h]	[mmH₂O]	[RPM]
8	3	C	S	NO	1,00	43,7%	47,1	2,985	32229	14,88	715
10	3	C	S	NO	1,00	42,7%	45,5	3,616	35052	16,18	708
12	4	C	S	NO	1,00	43,6%	46,0	4,112	38688	17,01	717
14	5,5	C	S	NO	1,00	47,5%	49,8	4,328	42421	17,79	733
16	5,5	C	S	NO	1,00	46,6%	48,5	5,017	45735	18,79	731
18	5,5	C	S	NO	1,00	46,0%	47,6	5,677	51754	18,54	728
20	5,5	C	S	NO	1,00	46,2%	47,4	6,370	53815	20,07	725
22	7,5	C	S	NO	1,00	45,5%	46,4	7,094	57078	20,77	729
24	7,5	C	S	NO	1,00	44,1%	44,7	8,060	58997	22,14	727
26	11	C	S	NO	1,00	43,8%	44,1	8,822	62213	22,80	732
28	11	C	S	NO	1,00	41,5%	41,6	10,048	67794	22,60	730
30	11	B	T	NO	1,00	59,8%	59,8	11,260	79607	31,09	727
32	11	B	T	NO	1,00	58,7%	58,6	12,374	83648	31,91	725
34	15	B	T	NO	1,00	59,2%	59,1	13,273	87155	33,13	730
36	15	B	T	NO	1,00	58,8%	58,6	14,432	90663	34,39	728
38	18,5	B	T	NO	1,00	58,3%	58,0	15,688	94364	35,61	731

#### HGT-140-8T/9

α [°]	PN	MC	EC	VSD	SR	ηe [%]	N	[kW]	[m³/h]	[mmH₂O]	[RPM]
8	4	C	S	NO	1,00	53,4%	55,7	4,396	24785	34,78	715
10	4	C	S	NO	1,00	47,2%	49,1	5,104	27479	32,24	710
12	5,5	C	S	NO	1,00	47,5%	49,3	5,178	33520	26,95	730
14	5,5	C	S	NO	1,00	46,1%	47,7	5,480	49072	18,90	729
16	7,5	C	S	NO	1,00	44,4%	45,6	6,538	53444	19,96	731
18	7,5	C	S	NO	1,00	43,4%	44,1	7,692	58154	21,09	728
20	11	C	S	NO	1,00	43,5%	43,9	8,755	62756	22,29	732
22	11	C	S	NO	1,00	42,4%	42,5	9,851	64904	23,64	730
24	11	C	S	NO	1,00	42,2%	42,2	10,906	66465	25,43	728
26	11	C	S	NO	1,00	42,2%	42,2	11,998	70586	26,37	726
28	15	C	S	NO	1,00	42,1%	42,0	13,034	74569	27,03	730
30	15	B	T	NO	1,00	64,6%	64,4	14,095	87828	38,06	729
32	15	B	T	NO	1,00	63,8%	63,6	15,621	90477	40,47	727
34	18,5	B	T	NO	1,00	61,6%	61,3	17,406	93362	42,22	729
36	22	B	T	NO	1,00	61,9%	61,5	18,369	96329	43,35	738
38	22	B	T	NO	1,00	60,1%	59,6	20,012	98939	44,63	737



### Erp. Características del punto de máxima eficiencia (BEP)

#### HGT-160-6T/3

α [°]	PN	MC	EC	VSD	SR	ηe [%]	N	[kW]	[m³/h]	[mmH₂O]	[RPM]
8	7,5	C	S	NO	1,00	46,1%	47,0	7,367	54320	22,98	978
10	11	C	S	NO	1,00	47,0%	47,4	8,712	61231	24,57	982
12	11	C	S	NO	1,00	48,0%	48,1	10,113	68287	26,10	979
14	11	C	S	NO	1,00	49,2%	49,2	11,514	75445	27,60	976
16	15	C	S	NO	1,00	48,6%	48,5	13,224	81399	29,00	980
18	15	C	S	NO	1,00	48,0%	47,8	15,045	88088	30,14	977
20	18,5	C	S	NO	1,00	47,2%	46,9	17,077	94775	31,26	983
22	18,5	C	S	NO	1,00	45,3%	44,9	19,703	100960	32,47	980
24	22	C	S	NO	1,00	44,7%	44,2	21,931	105875	34,02	982
26	22	C	S	NO	1,00	44,2%	43,5	24,285	110931	35,51	980
28	30	C	S	NO	1,00	42,5%	41,8	26,373	117291	35,09	988
30	37	B	T	NO	1,00	66,9%	66,1	29,338	141484	50,94	989
32	37	B	T	NO	1,01	67,1%	66,2	31,756	148014	52,85	988
34	37	B	T	NO	1,01	64,4%	63,5	34,934	151742	54,44	987
36	45	B	T	NO	1,01	63,6%	62,6	37,762	158387	55,68	988
38	45	B	T	NO	1,01	63,0%	62,0	40,772	164263	57,49	987

#### HGT-160-6T/6

α [°]	PN	MC	EC	VSD	SR	ηe [%]	N	[kW]	[m³/h]	[mmH₂O]	[RPM]
8	11	C	S	NO	1,00	50,8%	50,8	11,508	63476	33,83	976
10	15	C	S	NO	1,00	49,5%	49,4	13,960	69036	36,80	979
12	15	C	S	NO	1,00	49,7%	49,4	16,140	76198	38,68	975
14	18,5	C	S	NO	1,00	49,6%	49,2	18,546	83550	40,46	982
16	22	C	S	NO	1,01	49,1%	48,6	21,327	90077	42,72	982
18	22	C	S	NO	1,01	48,5%	47,9	24,132	101933	42,15	980
20	30	C	S	NO	1,01	49,4%	48,8	26,633	105991	45,64	988
22	30	C	S	NO	1,01	47,9%	47,1	30,181	112419	47,22	986
24	37	C	S	NO	1,01	46,2%	45,3	34,179	120236	48,25	987
26	37	C	S	NO	1,01	44,8%	43,9	37,854	124823	49,92	986
28	45	C	S	NO	1,01	43,9%	42,8	42,584	133523	51,39	987
30	55	B	T	NO	1,01	63,6%	62,4	47,465	156789	70,70	988
32	55	B	T	NO	1,01	62,4%	61,2	52,160	164748	72,55	987
34	75	B	T	NO	1,01	62,2%	61,0	56,552	171656	75,33	993
36	75	B	T	NO	1,01	61,8%	60,5	61,489	178566	78,19	992
38	75	B	T	NO	1,01	61,8%	60,4	66,248	185855	80,97	992

#### HGT-160-6T/9

α [°]	PN	MC	EC	VSD	SR	ηe [%]	N	[kW]	[m³/h]	[mmH₂O]	[RPM]
8	18,5	C	S	NO	1,01	60,2%	59,8	17,468	48815	79,09	983
10	18,5	C	S	NO	1,01	53,2%	52,8	20,284	54121	73,30	980
12	22	C	S	NO	1,01	50,0%	49,5	22,013	66019	61,29	982
14	22	C	S	NO	1,01	48,5%	47,9	23,296	96649	42,97	980
16	30	C	S	NO	1,01	46,8%	46,0	27,815	105260	45,39	987
18	30	C	S	NO	1,01	45,7%	44,8	32,725	114536	47,95	985
20	37	C	S	NO	1,01	45,5%	44,6	37,471	123602	50,68	986
22	45	C	S	NO	1,01	44,8%	43,8	41,749	127831	53,75	987
24	45	C	S	NO	1,01	44,2%	43,1	46,259	136572	55,04	986
26	55	C	S	NO	1,01	44,9%	43,7	50,577	139024	59,97	987
28	55	C	S	NO	1,01	44,3%	43,0	56,273	150233	60,93	986
30	75	B	T	NO	1,01	67,9%	66,6	59,994	173360	86,28	992
32	75	B	T	NO	1,01	67,1%	65,7	66,557	178199	92,03	992
34	75	B	T	NO	1,01	65,4%	63,9	73,505	183881	96,00	991
36	75	B	T	NO	1,01	63,6%	62,1	80,007	189724	98,58	990
38	90	B	T	NO	1,01	62,2%	60,6	86,518	194865	101,48	991



**Erp. Características del punto de máxima eficiencia (BEP)**

**HGT-160-8T/3**

α [°]	PN	MC	EC	VSD	SR	ηe [%]	N	[kW]	[m³/h]	[mmH₂O]	[RPM]
8	3	C	S	NO	1,00	40,0%	42,8	3,697	41169	13,20	707
10	4	C	S	NO	1,00	41,2%	43,5	4,333	46407	14,12	716
12	4	C	S	NO	1,00	42,0%	43,9	5,030	51755	14,99	710
14	5,5	C	S	NO	1,00	46,5%	48,2	5,312	57179	15,86	729
16	5,5	C	S	NO	1,00	45,9%	47,3	6,093	61692	16,66	726
18	7,5	C	S	NO	1,00	46,2%	47,3	6,812	66761	17,31	730
20	7,5	C	S	NO	1,00	46,0%	46,7	7,636	71830	17,96	728
22	11	C	S	NO	1,00	44,6%	45,0	8,710	76517	18,65	733
24	11	C	S	NO	1,00	43,7%	43,8	9,772	80242	19,54	730
26	11	C	S	NO	1,00	43,0%	43,1	10,884	85565	20,11	728
28	11	C	S	NO	1,00	40,7%	40,6	12,012	89790	20,00	726
30	15	B	T	NO	1,00	65,5%	65,4	13,035	107486	29,19	730
32	15	B	T	NO	1,00	65,5%	65,4	14,145	112179	30,36	729
34	18,5	B	T	NO	1,00	62,4%	62,1	15,700	115004	31,27	731
36	18,5	B	T	NO	1,00	61,0%	60,6	17,138	120041	31,98	729
38	18,5	B	T	NO	1,00	60,5%	60,1	18,504	124494	33,02	728

**HGT-160-8T/6**

α [°]	PN	MC	EC	VSD	SR	ηe [%]	N	[kW]	[m³/h]	[mmH₂O]	[RPM]
8	5,5	C	S	NO	1,00	47,9%	49,7	5,309	48108	19,43	729
10	5,5	C	S	NO	1,00	46,8%	48,0	6,432	52322	21,14	725
12	7,5	C	S	NO	1,00	47,8%	48,7	7,308	57750	22,22	729
14	7,5	C	S	NO	1,00	48,3%	48,8	8,293	63322	23,24	726
16	11	C	S	NO	1,00	48,0%	48,2	9,503	68269	24,54	731
18	11	C	S	NO	1,00	47,4%	47,4	10,753	77254	24,21	728
20	11	C	S	NO	1,00	47,5%	47,5	12,067	80330	26,22	726
22	15	C	S	NO	1,00	47,1%	46,9	13,370	85202	27,12	730
24	15	C	S	NO	1,00	45,2%	45,0	15,185	90276	27,95	727
26	18,5	C	S	NO	1,00	44,6%	44,3	16,882	93251	29,67	730
28	18,5	C	S	NO	1,00	42,1%	41,6	19,327	101197	29,52	727
30	22	B	T	NO	1,00	62,6%	62,1	20,999	118830	40,61	737
32	30	B	T	NO	1,00	60,2%	59,6	23,536	124862	41,67	736
34	30	B	T	NO	1,00	59,3%	58,7	25,820	130097	43,27	734
36	30	B	T	NO	1,00	58,9%	58,2	28,074	135334	44,91	733
38	37	B	T	NO	1,00	59,5%	58,7	29,981	140858	46,51	739

**HGT-160-8T/9**

α [°]	PN	MC	EC	VSD	SR	ηe [%]	N	[kW]	[m³/h]	[mmH₂O]	[RPM]
8	7,5	C	S	NO	1,00	58,6%	59,3	7,811	36997	45,43	727
10	11	C	S	NO	1,00	52,4%	52,7	8,968	41018	42,11	732
12	11	C	S	NO	1,00	48,9%	49,0	9,808	50036	35,21	730
14	11	C	S	NO	1,00	47,4%	47,5	10,380	73250	24,68	729
16	15	C	S	NO	1,00	45,9%	45,9	12,322	79776	26,07	732
18	15	C	S	NO	1,00	44,9%	44,7	14,497	86806	27,54	728
20	15	C	S	NO	1,00	44,5%	44,2	16,691	93677	29,11	725
22	18,5	C	S	NO	1,00	43,0%	42,6	18,948	96883	30,88	727
24	22	C	S	NO	1,00	43,8%	43,3	20,352	100570	32,57	737
26	22	C	S	NO	1,00	44,2%	43,6	22,376	105365	34,45	736
28	30	C	S	NO	1,00	42,6%	42,0	25,367	111878	35,51	735
30	30	B	T	NO	1,00	64,7%	64,0	27,420	131101	49,71	734
32	30	B	T	NO	1,01	64,0%	63,2	30,388	135056	52,86	732
34	30	B	T	NO	1,01	62,3%	61,5	33,561	139362	55,14	730
36	37	B	T	NO	1,01	61,2%	60,3	36,208	143791	56,62	737
38	37	B	T	NO	1,01	59,4%	58,4	39,446	147687	58,29	735



### Erp. Características del punto de máxima eficiencia (BEP)

#### HGTX-125-4T/3

α [°]	PN	MC	EC	VSD	SR	ηe [%]	N	[kW]	[m³/h]	[mmH <sub>2</sub> O]	[RPM]
8	7,5	C	S	NO	1,00	51,5%	52,2	7,711	41511	35,13	1467
10	11	C	S	NO	1,00	52,6%	52,9	9,099	46792	37,56	1477
12	11	C	S	NO	1,00	53,7%	53,7	10,562	52185	39,90	1474
14	15	C	S	NO	1,01	55,6%	55,6	11,909	57655	42,19	1474
16	15	C	S	NO	1,01	55,0%	54,8	13,660	62205	44,33	1471
18	15	C	S	NO	1,01	54,3%	54,1	15,540	67316	46,06	1467
20	18,5	C	S	NO	1,01	54,0%	53,7	17,441	72427	47,79	1474
22	22	C	S	NO	1,01	52,4%	51,9	19,912	77315	49,54	1475
24	30	C	S	NO	1,01	51,1%	50,5	22,192	82218	50,63	1486
26	30	C	S	NO	1,01	51,1%	50,5	24,492	84773	54,27	1485
28	30	C	S	NO	1,01	48,0%	47,3	27,048	90252	52,81	1483
30	37	C	S	NO	1,01	46,0%	45,2	29,760	94744	53,05	1485
32	37	C	S	NO	1,01	44,3%	43,4	32,325	99128	53,03	1484
34	37	B	T	NO	1,01	73,8%	72,9	36,069	116210	84,11	1482
36	45	B	T	NO	1,01	72,1%	71,1	39,418	121252	86,13	1479
38	45	B	T	NO	1,01	71,6%	70,5	42,561	125686	89,03	1478

#### HGTX-125-4T/6

α [°]	PN	MC	EC	VSD	SR	ηe [%]	N	[kW]	[m³/h]	[mmH <sub>2</sub> O]	[RPM]
8	15	C	S	NO	1,01	57,4%	57,3	11,903	48508	51,71	1474
10	15	C	S	NO	1,01	56,0%	55,8	14,419	52757	56,25	1469
12	18,5	C	S	NO	1,01	56,1%	55,8	16,692	58230	59,12	1475
14	22	C	S	NO	1,01	57,4%	57,0	18,738	63848	61,84	1476
16	30	C	S	NO	1,01	56,9%	56,4	21,508	68837	65,30	1487
18	30	C	S	NO	1,01	56,1%	55,5	24,338	77896	64,43	1485
20	30	C	S	NO	1,01	56,3%	55,6	27,311	80997	69,77	1483
22	37	C	S	NO	1,01	54,5%	53,7	30,984	85910	72,17	1484
24	37	C	S	NO	1,01	53,4%	52,5	34,825	88480	77,19	1482
26	45	C	S	NO	1,01	51,8%	50,8	39,017	93638	79,23	1480
28	45	C	S	NO	1,01	49,1%	48,0	44,439	102038	78,56	1477
30	55	C	S	NO	1,01	46,4%	45,3	49,055	106474	78,56	1483
32	55	C	S	NO	1,01	44,0%	42,8	53,907	110911	78,56	1481
34	75	B	T	NO	1,01	70,0%	68,7	59,412	131496	116,23	1489
36	75	B	T	NO	1,01	69,6%	68,2	64,610	136742	120,78	1488
38	75	B	T	NO	1,01	69,6%	68,2	69,618	142272	125,19	1487

#### HGTX-125-4T/9

α [°]	PN	MC	EC	VSD	SR	ηe [%]	N	[kW]	[m³/h]	[mmH <sub>2</sub> O]	[RPM]
8	18,5	C	S	NO	1,01	68,8%	68,4	17,841	37304	120,90	1473
10	22	C	S	NO	1,01	61,6%	61,1	20,493	41359	112,05	1474
12	30	C	S	NO	1,01	58,0%	57,4	22,200	50452	93,68	1486
14	30	C	S	NO	1,01	56,2%	55,6	23,494	73859	65,67	1485
16	30	C	S	NO	1,01	53,3%	52,5	28,523	80439	69,38	1482
18	37	C	S	NO	1,01	52,0%	51,1	33,595	87528	73,29	1483
20	45	C	S	NO	1,01	51,4%	50,5	38,723	94456	77,46	1480
22	45	C	S	NO	1,01	50,2%	49,1	43,568	97688	82,16	1477
24	55	C	S	NO	1,01	49,8%	48,7	48,010	101406	86,68	1483
26	55	C	S	NO	1,01	50,2%	49,0	52,784	106241	91,67	1482
28	75	C	S	NO	1,01	49,2%	47,9	58,335	112236	93,94	1489
30	75	C	S	NO	1,01	48,8%	47,5	64,192	120361	95,67	1488
32	75	C	S	NO	1,01	47,8%	46,3	69,802	125253	97,81	1487
34	90	B	T	NO	1,01	73,9%	72,4	76,797	140724	148,06	1488
36	90	B	T	NO	1,01	71,9%	70,3	83,592	145177	152,12	1487
38	90	B	T	NO	1,02	69,8%	68,2	91,080	149120	156,66	1486



### Erp. Características del punto de máxima eficiencia (BEP)

#### HGTX-125-6T/3

α [°]	PN	MC	EC	VSD	SR	ηe [%]	N	[kW]	[m³/h]	[mmH₂O]	[RPM]
8	3	C	S	NO	1,00	46,2%	50,1	2,418	27197	15,08	973
10	3	C	S	NO	1,00	46,9%	50,3	2,870	30657	16,12	968
12	3	C	S	NO	1,00	48,0%	51,1	3,318	34190	17,13	963
14	4	C	S	NO	1,00	50,1%	52,8	3,720	37774	18,11	968
16	4	C	S	NO	1,00	49,7%	52,1	4,247	40755	19,03	964
18	5,5	C	S	NO	1,00	50,5%	52,6	4,697	44104	19,77	981
20	5,5	C	S	NO	1,00	50,6%	52,4	5,239	47452	20,51	979
22	7,5	C	S	NO	1,00	50,4%	51,9	5,817	50654	21,27	983
24	7,5	C	S	NO	1,00	49,4%	50,6	6,524	53010	22,32	981
26	7,5	C	S	NO	1,00	48,6%	49,5	7,266	56526	22,97	978
28	11	C	S	NO	1,00	46,3%	47,0	7,959	59317	22,84	984
30	11	C	S	NO	1,00	44,2%	44,6	8,702	62074	22,77	982
32	11	C	S	NO	1,00	42,6%	42,8	9,452	64946	22,76	981
34	11	B	T	NO	1,00	71,0%	71,0	10,547	76138	36,11	978
36	15	B	T	NO	1,00	69,4%	69,3	11,528	79441	36,97	982
38	15	B	T	NO	1,00	68,8%	68,7	12,447	82346	38,21	981

#### HGTX-125-6T/6

α [°]	PN	MC	EC	VSD	SR	ηe [%]	N	[kW]	[m³/h]	[mmH₂O]	[RPM]
8	4	C	S	NO	1,00	51,7%	54,4	3,718	31781	22,20	968
10	5,5	C	S	NO	1,00	52,0%	54,3	4,371	34565	24,14	983
12	5,5	C	S	NO	1,00	52,5%	54,4	5,024	38151	25,38	980
14	5,5	C	S	NO	1,00	53,3%	54,9	5,668	41832	26,55	978
16	7,5	C	S	NO	1,00	54,2%	55,5	6,344	45100	28,03	981
18	7,5	C	S	NO	1,00	53,5%	54,5	7,179	51036	27,66	979
20	11	C	S	NO	1,00	54,1%	54,7	7,995	53067	29,95	984
22	11	C	S	NO	1,00	52,4%	52,7	9,060	56286	30,98	981
24	11	C	S	NO	1,00	51,0%	51,1	10,248	57719	33,26	979
26	11	C	S	NO	1,00	49,8%	49,8	11,396	61349	34,01	977
28	15	C	S	NO	1,00	47,2%	47,1	12,996	66852	33,72	980
30	15	C	S	NO	1,00	44,4%	44,2	14,423	69759	33,72	978
32	18,5	C	S	NO	1,00	41,6%	41,3	16,048	72666	33,72	984
34	18,5	B	T	NO	1,00	65,8%	65,4	17,781	86152	49,89	982
36	22	B	T	NO	1,01	65,9%	65,5	19,186	89589	51,84	984
38	22	B	T	NO	1,01	66,0%	65,5	20,673	93213	53,74	983

#### HGTX-125-6T/9

α [°]	PN	MC	EC	VSD	SR	ηe [%]	N	[kW]	[m³/h]	[mmH₂O]	[RPM]
8	5,5	C	S	NO	1,01	64,5%	66,2	5,354	24441	51,89	979
10	7,5	C	S	NO	1,00	59,3%	60,7	5,987	27097	48,10	982
12	7,5	C	S	NO	1,00	55,3%	56,4	6,548	33055	40,21	981
14	7,5	C	S	NO	1,00	53,6%	54,6	6,930	48390	28,19	979
16	11	C	S	NO	1,00	51,2%	51,7	8,350	52702	29,78	983
18	11	C	S	NO	1,00	50,0%	50,1	9,823	57346	31,46	980
20	15	C	S	NO	1,00	49,5%	49,4	11,325	61885	33,25	983
22	15	C	S	NO	1,00	48,2%	48,1	12,742	64003	35,27	981
24	15	C	S	NO	1,00	48,0%	47,8	14,106	65542	37,94	979
26	15	C	S	NO	1,01	48,0%	47,8	15,519	69606	39,35	976
28	18,5	C	S	NO	1,01	46,2%	45,9	17,458	73534	40,32	983
30	18,5	C	S	NO	1,01	45,9%	45,5	19,211	78857	41,07	981
32	22	C	S	NO	1,01	45,2%	44,8	20,727	82062	41,98	983
34	22	B	T	NO	1,01	69,6%	69,0	22,925	92199	63,56	981
36	30	B	T	NO	1,01	68,9%	68,3	24,541	95116	65,30	989
38	30	B	T	NO	1,01	66,9%	66,2	26,740	97699	67,25	988



### Erp. Características del punto de máxima eficiencia (BEP)

#### HGTX-125-8T/3

α [°]	PN	MC	EC	VSD	SR	ηe [%]	N	[kW]	[m³/h]	[mmH <sub>2</sub> O]	[RPM]
8	1,1	C	S	NO	1,00	39,7%	45,5	1,223	20612	8,66	713
10	1,5	C	S	NO	1,00	41,6%	47,0	1,409	23235	9,26	718
12	1,5	C	S	NO	1,00	42,5%	47,5	1,633	25912	9,84	713
14	2,2	C	S	NO	1,00	43,7%	48,3	1,856	28629	10,40	721
16	2,2	C	S	NO	1,00	43,3%	47,5	2,125	30888	10,93	717
18	2,2	C	S	NO	1,00	42,8%	46,8	2,412	33426	11,36	713
20	3	C	S	NO	1,00	44,2%	47,9	2,611	35964	11,78	719
22	3	C	S	NO	1,00	42,5%	45,8	3,003	38311	12,24	715
24	3	C	S	NO	1,00	42,3%	45,3	3,325	38268	13,50	711
26	4	C	S	NO	1,00	42,0%	44,8	3,649	42094	13,38	721
28	4	C	S	NO	1,00	39,9%	42,4	4,017	44508	13,23	718
30	4	C	S	NO	1,00	38,1%	40,4	4,390	46875	13,12	715
32	5,5	C	S	NO	1,00	39,6%	41,9	4,421	49222	13,07	733
34	5,5	B	T	NO	1,00	66,3%	68,3	4,912	57704	20,74	731
36	5,5	B	T	NO	1,00	65,2%	66,9	5,341	60208	21,24	729
38	5,5	B	T	NO	1,00	64,9%	66,4	5,746	62409	21,95	728

#### HGTX-125-8T/6

α [°]	PN	MC	EC	VSD	SR	ηe [%]	N	[kW]	[m³/h]	[mmH <sub>2</sub> O]	[RPM]
8	2,2	C	S	NO	1,00	45,1%	49,7	1,855	24087	12,75	721
10	2,2	C	S	NO	1,00	44,1%	48,3	2,241	26197	13,87	715
12	2,2	C	S	NO	1,00	44,4%	48,1	2,584	28914	14,58	710
14	3	C	S	NO	1,00	46,5%	50,0	2,831	31704	15,25	717
16	3	C	S	NO	1,00	45,8%	48,9	3,270	34181	16,10	712
18	4	C	S	NO	1,00	46,1%	48,9	3,627	38680	15,89	721
20	4	C	S	NO	1,00	46,4%	48,9	4,056	40219	17,20	718
22	4	C	S	NO	1,00	45,2%	47,3	4,576	42659	17,80	714
24	5,5	C	S	NO	1,00	47,0%	49,0	4,809	45625	18,18	731
26	5,5	C	S	NO	1,00	46,7%	48,5	5,289	46496	19,54	729
28	5,5	C	S	NO	1,00	44,6%	46,0	5,988	50667	19,37	727
30	7,5	C	S	NO	1,00	42,7%	43,9	6,531	52870	19,37	731
32	7,5	C	S	NO	1,00	40,5%	41,4	7,176	55073	19,37	729
34	7,5	B	T	NO	1,00	64,1%	64,7	7,951	65294	28,66	727
36	11	B	T	NO	1,00	64,4%	64,8	8,549	67899	29,78	733
38	11	B	T	NO	1,00	64,4%	64,7	9,211	70645	30,87	732

#### HGTX-125-8T/9

α [°]	PN	MC	EC	VSD	SR	ηe [%]	N	[kW]	[m³/h]	[mmH <sub>2</sub> O]	[RPM]
8	3	C	S	NO	1,00	56,3%	59,9	2,670	18524	29,81	719
10	3	C	S	NO	1,00	50,0%	53,2	3,090	20537	27,63	714
12	3	C	S	NO	1,00	46,7%	49,7	3,372	25052	23,10	711
14	4	C	S	NO	1,00	46,1%	49,0	3,505	36675	16,19	722
16	4	C	S	NO	1,00	44,0%	46,4	4,230	39942	17,11	716
18	5,5	C	S	NO	1,00	46,6%	48,8	4,588	43462	18,07	732
20	5,5	C	S	NO	1,00	46,4%	48,2	5,251	46902	19,10	730
22	5,5	C	S	NO	1,00	45,5%	47,0	5,875	48507	20,26	727
24	7,5	C	S	NO	1,00	46,1%	47,4	6,387	49674	21,79	731
26	7,5	C	S	NO	1,00	46,2%	47,2	7,027	52754	22,60	730
28	7,5	C	S	NO	1,00	45,0%	45,7	7,807	55731	23,16	727
30	11	C	S	NO	1,00	45,1%	45,5	8,493	59770	23,52	733
32	11	C	S	NO	1,00	44,2%	44,4	9,236	62194	24,12	732
34	11	B	T	NO	1,00	68,0%	68,0	10,215	69877	36,51	730
36	11	B	T	NO	1,00	66,2%	66,2	11,119	72088	37,51	728
38	15	B	T	NO	1,00	65,7%	65,7	11,845	74046	38,63	732



# HCT/MAR HFT/MAR

**HCT/MAR: Extractores helicoidales tubulares para intercalar en conducto, de gran robustez para aplicaciones marinas y navales**  
**HFT/MAR: Extractores helicoidales tubulares para principio de conducto, para aplicaciones marinas y navales**

Extractores helicoidales circulares con dos bridas (HFT) o tubulares para intercalar en conducto (HCT), para trabajar en ambientes marinos y equipados con motor para servicio marino.



HCT/MAR



HFT/MAR

**Ventilador:**

- HFT/MAR: Aro soporte con dos bridas en chapa de acero de gran robustez galvanizado en caliente
- HCT/MAR: Envolvente tubular en chapa de acero de gran robustez galvanizado en caliente, para intercalar entre conductos
- Hélice en fundición de aluminio
- Incorpora trampilla de inspección (HCT)
- Dirección aire motor-hélice

y 400/690V.-50Hz.(potencias superiores a 4 kW)

- Temperatura máxima del aire a transportar: -20°C.+ 60°C.

**Acabado:**

- Anticorrosivo galvanizado en caliente

**Bajo demanda:**

- Construcción en acero inoxidable
- Bobinados especiales para diferentes tensiones y frecuencias
- Construcción ATEX para diferentes categorías
- Motores con PTC incorporada
- Motores marinos para aplicaciones navales, con certificación para servicio esencial según diferentes entidades de clasificación (BV, DNV, LR)
- Motores de eficiencias IE2 e IE3 para cualquier potencia

**Motor:**

- Motores para servicio marino clase F, con rodamientos a bolas, protección IP55, con el cumplimiento de la clasificación para servicio naval no esencial.
- Motores de eficiencia IE3 para potencias iguales o superiores a 7,5kW, excepto monofásicos, 2 velocidades y 8 polos
- Trifásicos 230/400V.-50Hz.(hasta 4 kW)

Los motores marinos utilizados pueden estar certificados por la mayoría de entidades internacionales de clasificación naval:

ABS: América Bureau of shipping

BV: Bureau Veritas

CCS: China Classification Societies

CR: China Corporation Register of Shipping

DNV: Det Norske Veritas

GL: Germanischer Lloyd

KR: Korean Register of shipping

LR: Lloyd's Register of Shipping

NK: Nippon Kaiji Kyokai

RINA: Registro Italiano Navale

RS: Russian Maritime Register of Shipping

### Código de pedido



HCT/MAR: Extractores helicoidales tubulares para aplicaciones marinas  
 HFT/MAR: Extractores helicoidales tubulares para aplicaciones marinas

Diámetro de la hélice (cm)

Número de polos motor  
 2=2900 r/min. 50 Hz  
 4=1400 r/min. 50 Hz  
 6=900 r/min. 50 Hz

T=Trifásico

Potencia motor (c.v)

### Características técnicas

Modelo	Velocidad (r/min)	Intensidad máxima admisible (A)			Potencia instalada (kW)	Caudal máximo (m³/h)	Nivel presión sonora dB(A)	Peso aprox. con motor(Kg)	
		230V	400V	690V				HCT/MAR	HFT/MAR
HCT/MAR 35-2T	2710	1,92	1,11		0,37	5750	77	13	
HCT/MAR 35-4T	1320	0,65	0,38		0,09	3100	59	12	
HCT/MAR 40-2T-1,5	2860	4,20	2,40		1,10	8800	84	27	
HCT/MAR 40-4T-0,33	1350	1,66	0,96		0,25	5150	64	21	
HCT/MAR 45-2T-2	2770	5,44	3,13		1,50	10650	86	30	
HCT/MAR 45-2T-3	2885	7,77	4,47		2,20	12750	88	33	
HCT/MAR 45-4T-0,5	1370	2,02	1,17		0,37	7100	68	25	
HCT/MAR 50-4T-0,75	1380	2,92	1,69		0,55	10400	70	27	
HCT/MAR HFT/MAR 56-4T-0,75	1380	2,92	1,69		0,55	11050	72	32	22
HCT/MAR HFT/MAR 56-4T-1	1410	3,10	1,79		0,75	12950	73	34	23

**Características técnicas**

Modelo	Velocidad (r/min)	Intensidad máxima admisible (A)			Potencia instalada (kW)	Caudal máximo (m³/h)	Nivel presión sonora dB(A)	Peso aprox. con motor(Kg)	
		230V	400V	690V				HCT/MAR	HFT/MAR
HCT/MAR HFT/MAR 56-4T-1,5	1400	4,03	2,32		1,10	14000	74	36	27
HCT/MAR HFT/MAR 56-4T-2	1430	5,96	3,44		1,50	15300	75	39	29
HCT/MAR HFT/MAR 56-6T-0,33	900	1,51	0,87		0,25	8500	61	31	19
HCT/MAR HFT/MAR 56-6T-0,5	900	2,24	1,30		0,37	9300	61	34	21
HCT/MAR HFT/MAR 56-6T-0,75	900	2,99	1,73		0,55	10000	62	34	23
HCT/MAR HFT/MAR 63-4T-1	1410	3,10	1,79		0,75	14150	73	43	29
HCT/MAR HFT/MAR 63-4T-1,5	1400	4,03	2,32		1,10	17000	74	45	32
HCT/MAR HFT/MAR 63-4T-2	1430	5,96	3,44		1,50	18900	75	48	35
HCT/MAR HFT/MAR 63-4T-3	1445	8,36	4,83		2,20	22100	76	53	43
HCT/MAR HFT/MAR 63-4T-4	1445	10,96	6,33		3,00	25400	77	56	79
HCT/MAR HFT/MAR 63-6T-0,5	900	2,24	1,30		0,37	12150	64	43	27
HCT/MAR HFT/MAR 63-6T-0,75	900	2,99	1,73		0,55	12750	65	43	29
HCT/MAR HFT/MAR 63-6T-1	945	3,90	2,20		0,75	13800	66	45	35
HCT/MAR HFT/MAR 71-4T-1,5	1400	4,03	2,32		1,10	19750	78	51	35
HCT/MAR HFT/MAR 71-4T-2	1430	5,96	3,44		1,50	21100	79	54	38
HCT/MAR HFT/MAR 71-4T-3	1445	8,36	4,83		2,20	23950	81	60	47
HCT/MAR HFT/MAR 71-4T-4	1445	10,96	6,33		3,00	29400	82	63	49
HCT/MAR HFT/MAR 71-6T-0,75	900	2,99	1,73		0,55	15150	67	49	31
HCT/MAR HFT/MAR 71-6T-1	945	3,90	2,20		0,75	17250	68	51	38
HCT/MAR HFT/MAR 71-6T-1,5	945	4,88	2,82		1,10	20950	69	54	40
HCT/MAR HFT/MAR 80-4T-3	1445	8,36	4,83		2,20	28000	82	69	55
HCT/MAR HFT/MAR 80-4T-4	1445	10,96	6,33		3,00	32700	83	72	57
HCT/MAR HFT/MAR 80-4T-5,5	1440	14,10	8,12		4,00	37200	84	74	62
HCT/MAR HFT/MAR 80-6T-1	945	3,90	2,20		0,75	20600	71	60	46
HCT/MAR HFT/MAR 80-6T-1,5	945	4,88	2,82		1,10	24250	72	63	48
HCT/MAR HFT/MAR 80-6T-2	955	6,42	3,71		1,50	28000	73	71	54
HCT/MAR HFT/MAR 80-6T-3	955	9,30	5,30		2,20	32500	74	74	59
HCT/MAR HFT/MAR 90-4T-4	1445	10,96	6,33		3,00	37750	87	87	64
HCT/MAR HFT/MAR 90-4T-5,5	1440	14,10	8,12		4,00	41850	89	90	69
HCT/MAR HFT/MAR 90-4T-7,5	1440		11,60	6,72	5,50	47000	91	103	85
HCT/MAR HFT/MAR 90-4T-10 IE3	1465		13,90	8,06	7,50	53000	92	127	112
HCT/MAR HFT/MAR 90-6T-2	955	6,42	3,71		1,50	30000	77	86	61
HCT/MAR HFT/MAR 90-6T-3	955	9,30	5,30		2,20	35000	78	90	66
HCT/MAR HFT/MAR 90-6T-4	960	12,70	7,30		3,00	40000	79	102	90
HCT/MAR HFT/MAR 100-4T-7,5	1440		11,60	6,72	5,50	52500	92	115	93
HCT/MAR HFT/MAR 100-4T-10 IE3	1465		13,90	8,06	7,50	58500	93	138	120
HCT/MAR HFT/MAR 100-4T-15 IE3	1470		20,90	12,10	11,00	68000	94	184	152
HCT/MAR HFT/MAR 100-4T-20 IE3	1465		27,90	16,20	15,00	71850	95	195	163
HCT/MAR HFT/MAR 100-6T-3	955	9,30	5,30		2,20	40500	82	101	74
HCT/MAR HFT/MAR 100-6T-4	960	12,70	7,30		3,00	46950	83	113	98
HCT/MAR HFT/MAR 100-6T-5,5	960	16,50	9,46		4,00	52000	84	120	106

**Características acústicas**

Los valores indicados, se determinan mediante medidas de nivel de presión y potencia sonora en dB(A) obtenidas en campo libre a una distancia equivalente a dos veces la envergadura del ventilador más el diámetro de la hélice, con un mínimo de 1,5 mts.

**Espectro de potencia sonora Lw(A) en dB(A) banda de frecuencia en [Hz]**

Modelo	63	125	250	500	1000	2000	4000	8000	Modelo	63	125	250	500	1000	2000	4000	8000
35-2T	48	63	82	81	82	81	76	67	71-4T-4	59	79	87	92	94	91	84	73
35-4T	30	45	64	63	64	63	58	49	71-6T-0,75	44	64	72	77	79	76	69	58
40-2T-1,5	55	70	89	88	89	88	83	74	71-6T-1	45	65	73	78	80	77	70	59
40-4T-0,33	35	50	69	68	69	68	63	54	71-6T-1,5	46	66	74	79	81	78	71	60
45-2T-2	51	68	80	88	93	93	89	82	80-4T-3	59	79	87	92	94	91	84	73
45-2T-3	53	70	82	90	95	95	91	84	80-4T-4	60	80	88	93	95	92	85	74
45-4T-0,5	33	50	62	70	75	75	71	64	80-4T-5,5	61	81	89	94	96	93	86	75
50-4T-0,75	37	54	67	74	79	80	75	68	80-6T-1	48	68	76	81	83	80	73	62
56-4T-0,75	47	67	75	80	82	79	72	61	80-6T-1,5	49	69	77	82	84	81	74	63
56-4T-1	48	68	76	81	83	80	73	62	80-6T-2	50	70	78	83	85	82	75	64
56-4T-1,5	49	69	77	82	84	81	74	63	80-6T-3	51	71	79	84	86	83	76	65
56-4T-2	50	70	78	83	85	82	75	64	90-4T-4	65	86	93	98	101	97	90	79
56-6T-0,33	36	56	64	69	71	68	61	50	90-4T-5,5	67	88	95	100	103	99	92	81
56-6T-0,5	36	56	64	69	71	68	61	50	90-4T-7,5	69	90	97	102	105	101	94	83
56-6T-0,75	37	57	65	70	72	69	62	51	90-4T-10	70	91	98	103	106	102	95	84
63-4T-1	50	70	78	83	85	82	75	64	90-6T-2	55	76	83	88	91	87	80	69
63-4T-1,5	51	71	79	84	86	83	76	65	90-6T-3	56	77	84	89	92	88	81	70
63-4T-2	52	72	80	85	87	84	77	66	90-6T-4	57	78	85	90	93	89	82	71
63-4T-3	53	73	81	86	88	85	78	67	100-4T-7,5	72	92	100	105	107	104	97	86
63-4T-4	54	74	82	87	89	86	79	68	100-4T-10	73	93	101	106	108	105	98	87
63-6T-0,5	41	61	69	74	76	73	66	55	100-4T-15	74	94	102	107	109	106	99	88
63-6T-0,75	42	62	70	75	77	74	67	56	100-4T-20	75	95	103	108	110	107	100	89
63-6T-1	43	63	71	76	78	75	68	57	100-6T-3	62	82	90	95	97	94	87	76
71-4T-1,5	55	75	83	88	90	87	80	69	100-6T-4	63	83	91	96	98	95	88	77
71-4T-2	56	76	84	89	91	88	81	70	100-6T-5,5	64	84	92	97	99	96	89	78
71-4T-3	58	78	86	91	93	90	83	72									



Dimensiones mm

HCT/MAR

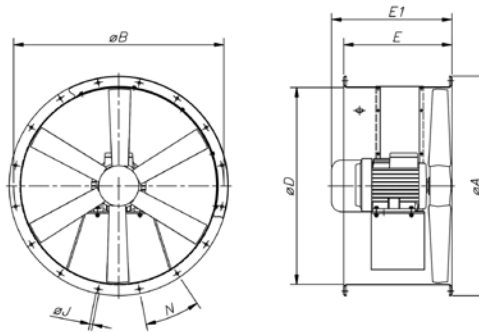

Modelo	ØA	ØB	ØD	E	E1	ØJ	N
HCT/MAR-35-2T	425	395	355	280	-	10	8x45°
HCT/MAR-35-4T	425	395	355	280	-	10	8x45°
HCT/MAR-40-2T-1,5	490	450	410	400	-	12	8x45°
HCT/MAR-40-4T-0,33	490	450	410	400	-	12	8x45°
HCT/MAR-45-2T-2	540	500	460	400	-	12	8x45°
HCT/MAR-45-2T-3	540	500	460	400	-	12	8x45°
HCT/MAR-45-4T-0,5	540	500	460	400	-	12	8x45°
HCT/MAR-50-4T-0,75	600	560	514	400	-	12	12x30°
HCT/MAR-56-4T-0,75	660	620	560	400	-	12	12x30°
HCT/MAR-56-4T-1	660	620	560	400	-	12	12x30°
HCT/MAR-56-4T-1,5	660	620	560	400	-	12	12x30°
HCT/MAR-56-4T-2	660	620	560	400	-	12	12x30°
HCT/MAR-56-6T-0,33	660	620	560	400	-	12	12x30°
HCT/MAR-56-6T-0,5	660	620	560	400	-	12	12x30°
HCT/MAR-56-6T-0,75	660	620	560	400	-	12	12x30°
HCT/MAR-63-4T-1	730	690	640	400	-	12	12x30°
HCT/MAR-63-4T-1,5	730	690	640	400	-	12	12x30°
HCT/MAR-63-4T-2	730	690	640	400	-	12	12x30°
HCT/MAR-63-4T-3	730	690	640	500	-	12	12x30°
HCT/MAR-63-4T-4	730	690	640	500	-	12	12x30°
HCT/MAR-63-6T-0,5	730	690	640	400	-	12	12x30°
HCT/MAR-63-6T-0,75	730	690	640	400	-	12	12x30°
HCT/MAR-63-6T-1	730	690	640	400	-	12	12x30°
HCT/MAR-71-4T-1,5	810	770	710	430	-	12	16x22°30'
HCT/MAR-71-4T-2	810	770	710	430	-	12	16x22°30'
HCT/MAR-71-4T-3	810	770	710	500	-	12	16x22°30'

Modelo	ØA	ØB	ØD	E	E1	ØJ	N
HCT/MAR-71-4T-4	810	770	710	500	-	12	16x22°30'
HCT/MAR-71-6T-0,75	810	770	710	430	-	12	16x22°30'
HCT/MAR-71-6T-1	810	770	710	500	-	12	16x22°30'
HCT/MAR-71-6T-1,5	810	770	710	500	-	12	16x22°30'
HCT/MAR-80-4T-3	900	860	800	500	-	12	16x22°30'
HCT/MAR-80-4T-4	900	860	800	500	-	12	16x22°30'
HCT/MAR-80-4T-5,5	900	860	800	500	-	12	16x22°30'
HCT/MAR-80-6T-1	900	860	800	500	-	12	16x22°30'
HCT/MAR-80-6T-1,5	900	860	800	500	-	12	16x22°30'
HCT/MAR-80-6T-2	900	860	800	500	-	12	16x22°30'
HCT/MAR-80-6T-3	900	860	800	500	-	12	16x22°30'
HCT/MAR-80-4T-4	1015	970	900	600	-	15	16x22°30'
HCT/MAR-90-4T-5,5	1015	970	900	600	-	15	16x22°30'
HCT/MAR-90-4T-7,5	1015	970	900	600	-	15	16x22°30'
HCT/MAR-90-4T-10	1015	970	900	600	-	15	16x22°30'
HCT/MAR-90-6T-2	1015	970	900	600	-	15	16x22°30'
HCT/MAR-90-6T-3	1015	970	900	600	-	15	16x22°30'
HCT/MAR-90-6T-4	1015	970	900	600	-	15	16x22°30'
HCT/MAR-100-4T-7,5	1115	1070	1000	600	-	15	16x22°30'
HCT/MAR-100-4T-10	1115	1070	1000	600	-	15	16x22°30'
HCT/MAR-100-4T-15	1115	1070	1000	700	-	15	16x22°30'
HCT/MAR-100-4T-20	1115	1070	1000	700	-	15	16x22°30'
HCT/MAR-100-6T-3	1115	1070	1000	600	-	15	16x22°30'
HCT/MAR-100-6T-4	1115	1070	1000	600	-	15	16x22°30'
HCT/MAR-100-6T-5,5	1115	1070	1000	600	-	15	16x22°30'

HFT/MAR

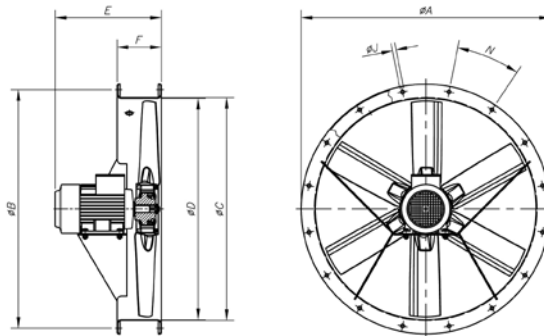

Modelo	øA	øB	øC	øD	E												F	øJ	N
					0,33	0,5	0,75	1	1,5	2	3	4	5,5	7,5	10	15			
HFT/MAR-56-4	660	620	564	560	-	-	344	344	376	376	-	-	-	-	-	-	150	12	12x30°
HFT/MAR-56-6	660	620	564	560	310	344	344	-	-	-	-	-	-	-	-	-	150	12	12x30°
HFT/MAR-63-4	730	690	645	640	-	-	-	325	398	398	430	430	-	-	-	-	150	12	12x30°
HFT/MAR-63-6	730	690	645	640	-	325	325	398	-	-	-	-	-	-	-	-	150	12	12x30°
HFT/MAR-71-4	810	770	715	710	-	-	-	-	400	400	440	440	-	-	-	-	150	12	16x22°30'
HFT/MAR-71-6	810	770	715	710	-	-	325	400	400	-	-	-	-	-	-	-	150	12	16x22°30'
HFT/MAR-80-4	900	860	805	800	-	-	-	-	-	-	425	425	445	-	-	-	180	12	16x22°30'
HFT/MAR-80-6	900	860	805	800	-	-	-	390	390	425	445	-	-	-	-	-	180	12	16x22°30'
HFT/MAR-90-4	1015	970	906	900	-	-	-	-	-	-	-	430	440	470	470	-	180	15	16x22°30'
HFT/MAR-90-6	1015	970	906	900	-	-	-	-	430	440	470	-	-	-	-	-	180	15	16x22°30'
HFT/MAR-100-4	1115	1070	1006	1000	-	-	-	-	-	-	-	-	485	485	590	590	200	15	16x22°30'
HFT/MAR-100-6	1115	1070	1006	1000	-	-	-	-	-	-	440	485	485	-	-	-	200	15	16x22°30'

Curvas Características

Ver curvas características en página 143



# HTMH

## Extractores de cubierta multifuncional para grandes caudales

Extractores de cubierta multifuncionales de robusta construcción para extracción de grandes caudales



**Ventilador:**

- Base soporte en chapa de acero galvanizada pintada
- Hélices orientables en fundición de aluminio
- Rejilla de protección contra contactos según norma UNE-EN ISO 12499:2010
- Sombbrero en chapa de acero galvanizada pintada, con salida de aire natural.

**Motor:**

- Motores de eficiencia IE2 para potencias iguales o superiores a 0,75kW e inferiores a 7,5kW, excepto monofásicos, 2 velocidades y 8 polos
- Motores de eficiencia IE3 para potencias iguales o superiores a 7,5kW, excepto monofásicos, 2 velocidades y 8 polos
- Motores clase F, con rodamientos a bolas, protección IP55, de 1 ó 2 velocidades según modelo
- Monofásicos 230V.-50Hz., y trifásicos 230/400V.-50Hz.(hasta 4 kW) y 400/690V.-50Hz.(potencias superiores a 4 kW)
- Temperatura de trabajo : -25°C.+ 50°C.

**Acabado:**

- Anticorrosivo en resina de poliéster polimerizada a 190 °C, previo desengrase con tratamiento nanotecnológico libre de fosfatos.
- Calidad acabado superficial C4H

**Bajo demanda:**

- Motores ATEX y de 2 Velocidades
- Construcción total en acero inoxidable
- Construcción en acero galvanizado en caliente
- Motores marinos para aplicaciones navales, con certificación para servicio esencial según diferentes entidades de clasificación (BV, DNV, LR)
- Motores CE, NEMA, UL, CSA
- Calidad acabado superficial C5M
- Motores de eficiencias IE2 e IE3 para cualquier potencia

### Código de pedido

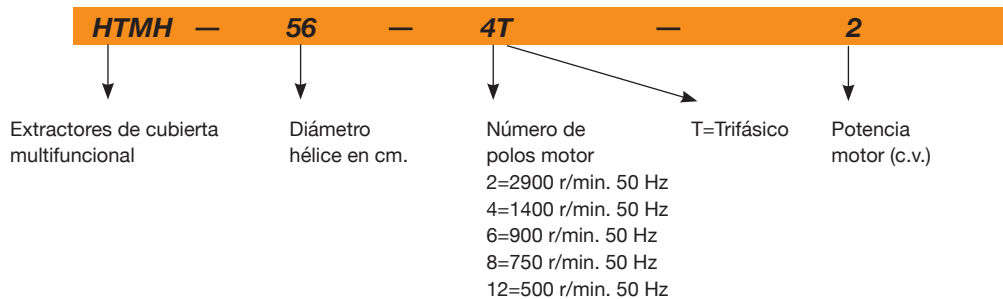

### Características técnicas

Modelo	Velocidad (r/min)	Intensidad máxima admisible (A)			Potencia instalada (kW)	Caudal máximo (m³/h)	Nivel presión (1) sonora dB(A)		Peso aprox. (Kg)
		230V	400V	690V			Aspiración	Descarga	
HTMH-56-4T-1	1410	2,83	1,63		0,75	10545	62	59	67
HTMH-56-4T-1.5	1400	4,03	2,32		1,10	11400	63	60	69
HTMH-56-4/8T-1.5	1440 / 710		2,90 / 1,30		1,10 / 0,25	11400 / 5700	63 / 48	60 / 45	67
HTMH-56-6T-0.75	910	2,59	1,49		0,55	8170	51	49	67
HTMH-63-4T-1.5	1400	4,03	2,32		1,10	13870	65	62	81
HTMH-63-4/8T-1.5	1440 / 710		2,90 / 1,30		1,10 / 0,25	13870 / 6935	65 / 50	62 / 47	79
HTMH-63-4T-2	1440	5,67	3,26		1,50	15485	66	63	87
HTMH-63-4/8T-2	1420 / 700		3,50 / 1,50		1,50 / 0,37	15485 / 7742	66 / 51	63 / 48	80
HTMH-63-4T-3	1435	8,07	4,64		2,20	17955	67	64	96
HTMH-63-4/8T-3	1430 / 710		4,90 / 1,70		2,20 / 0,45	17955 / 8977	67 / 52	64 / 49	86
HTMH-63-6T-0.75	910	2,59	1,49		0,55	10260	56	54	79
HTMH-63-6T-1	925	3,39	1,95		0,75	11305	57	55	84
HTMH-71-4T-2	1440	5,67	3,26		1,50	16150	69	66	93
HTMH-71-4/8T-2	1420 / 700		3,50 / 1,50		1,50 / 0,37	16150 / 8075	69 / 54	66 / 51	86
HTMH-71-4T-3	1435	8,07	4,64		2,20	18430	71	68	101
HTMH-71-4/8T-3	1430 / 710		4,90 / 1,70		2,20 / 0,45	18430 / 9215	71 / 56	68 / 53	91
HTMH-71-4T-4	1420	10,70	6,17		3,00	22610	72	69	104

**Características técnicas**

Modelo	Velocidad (r/min)	Intensidad máxima admisible (A)			Potencia instalada (kW)	Caudal máximo (m³/h)	Nivel presión (1) sonora dB(A)		Peso aprox. (Kg)
		230V	400V	690V			Aspiración	Descarga	
HTMH-71-4/8T-4	1430 / 710		6,50 / 2,30		3,00 / 0,60	22610 / 11305	72 / 57	69 / 54	98
HTMH-71-6T-1	925	3,39	1,95		0,75	13205	58	56	90
HTMH-71-6T-1.5	925	4,83	2,78		1,10	16245	59	57	94
HTMH-80-4T-4	1420	10,70	6,17		3,00	27600	73	70	127
HTMH-80-4/8T-4	1430 / 710		6,50 / 2,30		3,00 / 0,60	27600 / 13800	73 / 58	70 / 55	121
HTMH-80-4T-5.5	1440	14,10	8,12		4,00	30176	74	71	136
HTMH-80-4/8T-5.5	1430 / 710		8,20 / 2,90		4,00 / 0,80	30176 / 15088	74 / 59	71 / 56	125
HTMH-80-6T-1.5	925	4,83	2,78		1,10	19412	62	60	117
HTMH-80-6T-2	940	6,45	3,71		1,50	22172	63	61	122
HTMH-80-6T-3	955	10,30	5,94		2,20	24932	64	62	132
HTMH-80-8T-1	705	4,68	2,70		0,75	16376	61	60	117
HTMH-90-4T-5.5	1440	14,10	8,12		4,00	35052	79	76	158
HTMH-90-4/8T-5.5	1430 / 710		8,20 / 2,90		4,00 / 0,80	35052 / 17526	79 / 64	76 / 61	147
HTMH-90-4T-7.5	1460		10,50	6,09	5,50	38456	81	78	176
HTMH-90-4/8T-7.5	1450 / 720		11,80 / 3,80		5,50 / 1,10	38456 / 19228	81 / 66	78 / 63	166
HTMH-90-4T-10 IE3	1465		13,90	8,06	7,50	41308	82	79	194
HTMH-90-4/8T-9	1460 / 725		15,30 / 5,40		7,50 / 1,50	41308 / 20654	82 / 67	79 / 64	175
HTMH-90-6T-3	955	10,30	5,94		2,20	29256	68	66	154
HTMH-90-6/12T-3	940 / 470		5,60 / 2,20		2,20 / 0,37	29256 / 14628	68 / 53	66 / 51	148
HTMH-90-6T-4	960	12,70	7,30		3,00	32016	69	67	177
HTMH-90-6/12T-4	960 / 480		9,00 / 3,50		3,00 / 0,55	32016 / 16008	69 / 54	67 / 52	166
HTMH-90-8T-1	705	4,68	2,70		0,75	17020	61	60	139
HTMH-90-8T-2	705	7,10	4,10		1,50	19596	63	62	150
HTMH-100-4T-7.5	1460		10,50	6,09	5,50	40756	84	81	200
HTMH-100-4/8T-7.5	1450 / 720		11,80 / 3,80		5,50 / 1,10	40756 / 20378	84 / 69	81 / 66	190
HTMH-100-4T-10 IE3	1465		13,90	8,06	7,50	47564	85	82	218
HTMH-100-4/8T-9	1460 / 725		15,30 / 5,40		7,50 / 1,50	44528 / 22264	84 / 69	81 / 66	199
HTMH-100-4T-15 IE3	1470		20,90	12,10	11,00	51336	86	83	253
HTMH-100-4/8T-14	1470 / 725		23,20 / 8,70		11,00 / 2,80	48300 / 24150	85 / 70	82 / 67	230
HTMH-100-6T-3	955	10,30	5,94		2,20	32476	74	72	178
HTMH-100-6/12T-3	940 / 470		5,60 / 2,20		2,20 / 0,37	32476 / 16238	74 / 59	72 / 57	172
HTMH-100-6T-4	960	12,70	7,30		3,00	35420	75	73	201
HTMH-100-6/12T-4	960 / 480		9,00 / 3,50		3,00 / 0,55	35420 / 17710	75 / 60	73 / 58	190
HTMH-100-6T-5.5	960	16,50	9,46		4,00	40020	76	74	208
HTMH-100-6/12T-5.5	970 / 480		11,00 / 4,00		4,00 / 0,65	40020 / 20010	76 / 61	74 / 59	200
HTMH-100-8T-3	705	9,53	5,50		2,20	26404	69	68	186
HTMH-100-8T-4	705	12,82	7,40		3,00	28704	70	69	193
HTMH-125-4T/3-10 IE3	1465		13,90	8,06	7,50	55250	75	72	337
HTMH-125-4T/3-15 IE3	1470		21,40	12,40	11,00	72150	76	73	382
HTMH-125-4T/3-20 IE3	1465		28,70	16,60	15,00	83120	78	75	377
HTMH-125-4T/6-15 IE3	1470		21,40	12,40	11,00	66800	76	73	398
HTMH-125-4T/6-20 IE3	1465		28,70	16,60	15,00	72900	76	73	393
HTMH-125-4T/9-20 IE3	1465		28,70	16,60	15,00	76310	75	72	408
HTMH-125-6T/6-5.5	960	16,50	9,46		4,00	47760	63	61	343
HTMH-125-6T/6-7.5	960		12,80	7,42	5,50	55600	63	61	347
HTMH-125-6T/6-10 IE3	970		14,80	8,58	7,50	66170	65	63	369
HTMH-125-6T/6-15 IE3	970		22,00	12,80	11,00	76380	67	65	399
HTMH-125-6T/9-7.5	960		12,80	7,42	5,50	50000	64	62	362
HTMH-125-6T/9-10 IE3	970		14,80	8,58	7,50	59340	64	62	384
HTMH-125-6T/9-15 IE3	970		22,00	12,80	11,00	71890	67	65	414
HTMH-125-6T/9-20 IE3	975		28,00	16,20	15,00	83660	70	68	467
HTMH-125-8T/6-4	705	12,82	7,40		3,00	47510	56	55	328
HTMH-125-8T/6-5.5	710	16,11	9,30		4,00	52770	58	57	345
HTMH-125-8T/6-7.5	710		12,00	7,20	5,50	60410	60	59	361
HTMH-125-8T/6-10	725		16,00	9,50	7,50	66030	61	60	389
HTMH-125-8T/9-5.5	710	16,11	9,30		4,00	51330	58	57	360
HTMH-125-8T/9-7.5	710		12,00	7,20	5,50	54480	61	60	376
HTMH-125-8T/9-10	725		16,00	9,50	7,50	65660	63	62	404
HTMH-125-8T/9-15	720		24,00	13,80	11,00	73870	64	63	426

(1) Los valores de los niveles sonoros, son presiones en dB(A) medidos a 6 metros, en campo libre.

**Características acústicas**

Valores tomados a la aspiración con caudal máximo.

Valores tomados a la descarga con caudal máximo.

Espectro de potencia sonora  $L_w(A)$  en dB(A) banda de frecuencia en [Hz]

Modelo	63	125	250	500	1000	2000	4000	8000
56-4-1	46	67	74	79	82	78	71	60
56-4-1,5	47	68	75	80	83	79	72	61
56-6-0,75	35	56	63	68	71	67	60	49
56-8-1,5	32	53	60	65	68	64	57	46
63-4-1,5	49	70	77	82	85	81	74	63
63-4-2	50	71	78	83	86	82	75	64
63-4-3	51	72	79	84	87	83	76	65
63-6-0,75	40	61	68	73	76	72	65	54
63-6-1	41	62	69	74	77	73	66	55
63-8-1,5	34	55	62	67	70	66	59	48
63-8-2	35	56	63	68	71	67	60	49
63-8-3	36	57	64	69	72	68	61	50
71-4-2	53	74	81	86	89	85	78	67
71-4-3	55	76	83	88	91	87	80	69
71-4-4	56	77	84	89	92	88	81	70
71-6-1	42	63	70	75	78	74	67	56
71-6-1,5	43	64	71	76	79	75	68	57
71-8-2	38	59	66	71	74	70	63	52
71-8-3	40	61	68	73	76	72	65	54
71-8-4	41	62	69	74	77	73	66	55
80-4-4	57	78	85	90	93	89	82	71
80-4-5,5	58	79	86	91	94	90	83	72
80-6-1,5	46	67	74	79	82	78	71	60
80-6-2	47	68	75	80	83	79	72	61
80-6-3	48	69	76	81	84	80	73	62
80-8-1	45	66	73	78	81	77	70	59
80-8-4	42	63	70	75	78	74	67	56
80-8-5,5	43	64	71	76	79	75	68	57
90-4-5,5	63	84	91	96	99	95	88	77
90-4-7,5	65	86	93	98	101	97	90	79
90-4-9	66	87	94	99	102	98	91	80
90-4-10	66	87	94	99	102	98	91	80
90-6-3	52	73	80	85	88	84	77	66
90-6-4	53	74	81	86	89	85	78	67
90-8-1	45	66	73	78	81	77	70	59
90-8-2	47	68	75	80	83	79	72	61
90-8-5,5	48	69	76	81	84	80	73	62
90-8-7,5	50	71	78	83	86	82	75	64
90-8-9	51	72	79	84	87	83	76	65
90-12-3	37	58	65	70	73	69	62	51
90-12-4	38	59	66	71	74	70	63	52
100-4-7,5	68	89	96	101	104	100	93	82
100-4-9	68	89	96	101	104	100	93	82
100-4-10	69	90	97	102	105	101	94	83
100-4-14	69	90	97	102	105	101	94	83
100-4-15	70	91	98	103	106	102	95	84
100-6-3	58	79	86	91	94	90	83	72
100-6-4	59	80	87	92	95	91	84	73
100-6-5,5	60	81	88	93	96	92	85	74
100-8-3	53	74	81	86	89	85	78	67
100-8-4	54	75	82	87	90	86	79	68
100-8-7,5	53	74	81	86	89	85	78	67
100-8-9	53	74	81	86	89	85	78	67
100-8-14	54	75	82	87	90	86	79	68
100-12-3	43	64	71	76	79	75	68	57
100-12-4	44	65	72	77	80	76	69	58
100-12-5,5	45	66	73	78	81	77	70	59
125-4T/3-10	66	73	84	94	95	90	82	78
125-4T/3-15	67	74	85	95	96	91	83	79
125-4T/3-20	69	76	87	97	98	93	85	81
125-4T/6-15	63	72	87	94	97	91	85	81
125-4T/6-20	63	72	87	94	97	91	85	81
125-4T/9-20	62	71	87	93	95	89	84	80
125-6T/6-5,5	56	66	78	81	83	79	68	64
125-6T/6-7,5	56	66	78	81	83	79	68	64
125-6T/6-10	58	68	80	83	85	81	70	66
125-6T/6-15	60	70	82	85	87	83	72	68
125-6T/9-7,5	54	65	79	83	83	81	70	66
125-6T/9-10	54	65	79	83	83	81	70	66
125-6T/9-15	57	68	82	86	86	84	73	69
125-6T/9-20	60	71	85	89	89	87	76	72
125-8T/6-4	50	59	70	75	75	69	58	54
125-8T/6-5,5	52	61	72	77	77	71	60	56
125-8T/6-7,5	54	63	74	79	79	73	62	58
125-8T/6-10	55	64	75	80	80	74	63	59
125-8T/9-5,5	49	61	70	76	78	72	61	57
125-8T/9-7,5	52	64	73	79	81	75	64	60
125-8T/9-10	54	66	75	81	83	77	66	62
125-8T/9-15	55	67	76	82	84	78	67	63

Modelo	63	125	250	500	1000	2000	4000	8000
56-4-1	43	64	71	76	79	75	68	57
56-4-1,5	44	65	72	77	80	76	69	58
56-6-0,75	33	54	61	66	69	65	58	47
56-8-1,5	29	50	57	62	65	61	54	43
63-4-1,5	46	67	74	79	82	78	71	60
63-4-2	47	68	75	80	83	79	72	61
63-4-3	48	69	76	81	84	80	73	62
63-6-0,75	38	59	66	71	74	70	63	52
63-6-1	39	60	67	72	75	71	64	53
63-8-1,5	31	52	59	64	67	63	56	45
63-8-2	32	53	60	65	68	64	57	46
63-8-3	33	54	61	66	69	65	58	47
71-4-2	50	71	78	83	86	82	75	64
71-4-3	52	73	80	85	88	84	77	66
71-4-4	53	74	81	86	89	85	78	67
71-6-1	40	61	68	73	76	72	65	54
71-6-1,5	41	62	69	74	77	73	66	55
71-8-2	35	56	63	68	71	67	60	49
71-8-3	37	58	65	70	73	69	62	51
71-8-4	38	59	66	71	74	70	63	52
80-4-4	54	75	82	87	90	86	79	68
80-4-5,5	55	76	83	88	91	87	80	69
80-6-1,5	44	65	72	77	80	76	69	58
80-6-2	45	66	73	78	81	77	70	59
80-6-3	46	67	74	79	82	78	71	60
80-8-1	44	65	72	77	80	76	69	58
80-8-4	39	60	67	72	75	71	64	53
80-8-5,5	40	61	68	73	76	72	65	54
90-4-5,5	60	81	88	93	96	92	85	74
90-4-7,5	62	83	90	95	98	94	87	76
90-4-9	63	84	91	96	99	95	88	77
90-4-10	63	84	91	96	99	95	88	77
90-6-3	50	71	78	83	86	82	75	64
90-6-4	51	72	79	84	87	83	76	65
90-8-1	44	65	72	77	80	76	69	58
90-8-2	46	67	74	79	82	78	71	60
90-8-5,5	45	66	73	78	81	77	70	59
90-8-7,5	47	68	75	80	83	79	72	61
90-8-9	48	69	76	81	84	80	73	62
90-12-3	35	56	63	68	71	67	60	49
90-12-4	36	57	64	69	72	68	61	50
100-4-7,5	65	86	93	98	101	97	90	79
100-4-9	65	86	93	98	101	97	90	79
100-4-10	66	87	94	99	102	98	91	80
100-4-14	66	87	94	99	102	98	91	80
100-4-15	67	88	95	100	103	99	92	81
100-6-3	56	77	84	89	92	88	81	70
100-6-4	57	78	85	90	93	89	82	71
100-6-5,5	58	79	86	91	94	90	83	72
100-8-3	52	73	80	85	88	84	77	66
100-8-4	53	74	81	86	89	85	78	67
100-8-7,5	50	71	78	83	86	82	75	64
100-8-9	50	71	78	83	86	82	75	64
100-8-14	51	72	79	84	87	83	76	65
100-12-3	41	62	69	74	77	73	66	55
100-12-4	42	63	70	75	78	74	67	56
100-12-5,5	43	64	71	76	79	75	68	57
125-4T/3-10	63	70	81	91	92	87	79	75
125-4T/3-15	64	71	82	92	93	88	80	76
125-4T/3-20	66	73	84	94	95	90	82	78
125-4T/6-15	60	69	84	91	94	88	82	78
125-4T/6-20	60	69	84	91	94	88	82	78
125-4T/9-20	59	68	84	90	92	86	81	77
125-6T/6-5,5	54	64	76	79	81	77	66	62
125-6T/6-7,5	54	64	76	79	81	77	66	62
125-6T/6-10	56	66	78	81	83	79	68	64
125-6T/6-15	58	68	80	83	85	81	70	66
125-6T/9-7,5	52	63	77	81	81	79	68	64
125-6T/9-10	52	63	77	81	81	79	68	64
125-6T/9-15	55	66	80	84	84	82	71	67
125-6T/9-20	58	69	83	87	87	85	74	70
125-8T/6-4	49	58	69	74	74	68	57	53
125-8T/6-5,5	51	60	71	76	76	70	59	55
125-8T/6-7,5	53	62	73	78	78	72	61	57
125-8T/6-10	54	63	74	79	79	73	62	58
125-8T/9-5,5	48	60	69	75	77	71	60	56
125-8T/9-7,5	51	63	72	78	80	74	63	59
125-8T/9-10	53	65	74	80	82	76	65	61
125-8T/9-15	54	66	75	81	83	77	66	62



**Erp. Características del punto de máxima eficiencia (BEP)**

<b>MC</b>	Categoría de medición	<b>ηe[%]</b>	Eficiencia
<b>EC</b>	Categoría de eficiencia	<b>N</b>	Grado de eficiencia
<b>S</b>	Estática	<b>[kW]</b>	Potencia eléctrica
<b>T</b>	Total	<b>[m³/h]</b>	Caudal
<b>VSD</b>	Variador de velocidad	<b>[mmH<sub>2</sub>O]</b>	Presión estática o total (Según EC)
<b>SR</b>	Relación específica	<b>[RPM]</b>	Velocidad

Modelo	MC	EC	VSD	SR	ηe [%]	N	[kW]	[m3/h]	[mmH <sub>2</sub> O]	[RPM]
HTMH-56-4T-1	C	S	NO	1,00	35,4%	42,1	0,85	7901	14,07	1418
HTMH-56-4T-1,5	B	T	NO	1,00	48,5%	54,4	1,16	11340	18,14	1414
HTMH-56-4/8T-1,5	B	T	NO	1,00	44,9%	50,5	1,33	11588	18,94	1445
HTMH-56-6T-0,75	B	T	NO	1,00	42,7%	50,8	0,52	9212	8,77	934
HTMH-63-4T-1,5	C	S	NO	1,00	48,2%	54,3	1,11	10387	18,88	1418
HTMH-63-4/8T-1,5	C	S	NO	1,00	41,3%	46,8	1,38	10605	19,68	1447
HTMH-63-4T-2	C	S	NO	1,00	42,4%	47,6	1,54	12016	20,00	1449
HTMH-63-4/8T-2	C	S	NO	1,00	37,2%	42,1	1,70	11892	19,59	1434
HTMH-63-4T-3	B	T	NO	1,00	62,4%	66,6	2,19	19423	25,86	1446
HTMH-63-4/8T-3	B	T	NO	1,00	56,0%	59,9	2,42	19373	25,73	1442
HTMH-63-6T-0,75	B	T	NO	1,00	56,1%	64,1	0,55	11393	9,86	937
HTMH-63-6T-1	B	T	NO	1,00	54,9%	61,8	0,80	13916	11,57	939
HTMH-71-4T-2	C	S	NO	1,00	48,5%	53,8	1,49	13409	19,84	1450
HTMH-71-4/8T-2	C	S	NO	1,00	42,6%	47,5	1,65	13275	19,45	1436
HTMH-71-4T-3	C	S	NO	1,00	44,7%	48,9	2,16	16356	21,67	1446
HTMH-71-4/8T-3	C	S	NO	1,00	40,1%	44,0	2,39	16314	21,56	1443
HTMH-71-4T-4	B	T	NO	1,00	68,4%	71,8	2,87	23676	30,48	1434
HTMH-71-4/8T-4	B	T	NO	1,00	61,6%	64,8	3,24	23797	30,80	1441
HTMH-71-6T-1	B	T	NO	1,00	62,4%	69,3	0,82	14945	12,60	938
HTMH-71-6T-1,5	B	T	NO	1,00	59,2%	65,1	1,15	18001	13,88	939
HTMH-80-4T-4	C	S	NO	1,00	46,9%	50,1	3,22	20108	27,62	1426
HTMH-80-4/8T-4	C	S	NO	1,00	42,3%	45,1	3,64	20222	27,93	1434
HTMH-80-4T-5,5	C	S	NO	1,00	45,5%	47,7	4,55	23694	32,11	1441
HTMH-80-4/8T-5,5	C	S	NO	1,00	43,3%	45,4	4,70	23552	31,72	1432
HTMH-80-6T-1,5	C	S	NO	1,00	38,9%	44,4	1,36	15261	12,68	928
HTMH-80-6T-2	B	T	NO	1,00	61,3%	65,9	1,85	24165	17,21	941
HTMH-80-6T-3	B	T	NO	1,00	64,9%	68,9	2,29	26615	20,53	961
HTMH-80-8T-1	B	T	NO	1,00	51,2%	57,2	1,13	18865	11,24	705
HTMH-90-4T-5,5	C	S	NO	1,00	51,0%	53,2	4,50	27512	30,65	1441
HTMH-90-4/8T-5,5	C	S	NO	1,00	48,6%	50,7	4,64	27348	30,28	1433
HTMH-90-4T-7,5	C	S	NO	1,00	47,8%	49,1	6,35	31725	35,17	1459
HTMH-90-4/8T-7,5	C	S	NO	1,00	43,0%	44,0	6,93	31525	34,73	1450
HTMH-90-4T-10 IE3	C	S	NO	1,01	46,3%	47,0	7,81	35188	37,75	1466
HTMH-90-4/8T-9	C	S	NO	1,00	43,0%	43,6	7,86	33548	36,97	1462
HTMH-90-6T-3	C	S	NO	1,00	42,8%	46,8	2,40	23147	16,33	959
HTMH-90-6/12T-3	C	S	NO	1,00	37,5%	41,2	2,64	22863	15,94	947
HTMH-90-6T-4	B	T	NO	1,00	63,7%	66,9	3,21	32972	22,77	964
HTMH-90-6/12T-4	B	T	NO	1,00	55,3%	58,1	3,70	32972	22,77	964
HTMH-90-8T-1	C	S	NO	1,00	36,4%	42,7	1,04	15838	8,76	708
HTMH-90-8T-2	B	T	NO	1,00	58,5%	63,9	1,40	24325	12,38	718
HTMH-100-4T-7,5	C	S	NO	1,00	50,5%	51,7	6,31	33024	35,42	1460
HTMH-100-4/8T-7,5	C	S	NO	1,00	45,4%	46,4	6,89	32817	34,98	1450
HTMH-100-4T-10 IE3	C	S	NO	1,00	49,0%	49,6	8,18	37734	39,02	1465
HTMH-100-4/8T-9	C	S	NO	1,00	45,8%	46,4	7,93	35548	37,50	1462
HTMH-100-4T-15 IE3	C	S	NO	1,01	44,9%	44,8	11,93	44732	43,97	1470
HTMH-100-4/8T-14	C	S	NO	1,01	39,0%	38,8	14,13	45164	44,82	1469
HTMH-100-6T-3	C	S	NO	1,00	45,4%	49,2	2,51	24808	16,87	957
HTMH-100-6/12T-3	C	S	NO	1,00	39,8%	43,3	2,75	24492	16,44	945
HTMH-100-6T-4	C	S	NO	1,00	41,1%	43,8	3,72	29458	19,07	958
HTMH-100-6/12T-4	C	S	NO	1,00	35,7%	38,0	4,29	29458	19,07	958
HTMH-100-6T-5,5	B	T	NO	1,00	61,3%	63,3	4,86	44005	24,89	959
HTMH-100-6/12T-5,5	B	T	NO	1,00	56,5%	58,2	5,44	44437	25,38	968
HTMH-100-8T-3	B	T	NO	1,00	52,5%	56,2	2,67	33957	15,20	709
HTMH-100-8T-4	B	T	NO	1,00	54,2%	57,8	2,77	41581	13,28	718
HTMH-125-4T/3-10 IE3	C	S	NO	1,00	52,3%	53,2	7,59	41511	35,13	1468
HTMH-125-4T/3-15 IE3	C	S	NO	1,01	56,1%	56,0	11,80	57655	42,19	1471



**Erp. Características del punto de máxima eficiencia (BEP)**

Modelo	MC	EC	VSD	SR	$\eta_e$ [%]	N	[kW]	[m <sup>3</sup> /h]	[mmH <sub>2</sub> O]	[RPM]
HTMH-125-4T/3-20 IE3	C	S	NO	1,01	55,2%	54,9	15,29	67316	46,06	1472
HTMH-125-4T/6-15 IE3	C	S	NO	1,01	57,8%	57,8	11,81	48508	51,71	1471
HTMH-125-4T/6-20 IE3	C	S	NO	1,01	56,9%	56,7	14,20	52757	56,25	1474
HTMH-125-4T/9-20 IE3	C	S	NO	1,01	70,4%	70,1	17,44	37304	120,90	1474
HTMH-125-6T/6-5,5	C	S	NO	1,00	53,1%	55,5	4,28	34565	24,14	972
HTMH-125-6T/6-7,5	C	S	NO	1,00	54,7%	56,3	5,53	41832	26,55	974
HTMH-125-6T/6-10 IE3	C	S	NO	1,00	55,2%	55,9	7,84	53067	29,95	972
HTMH-125-6T/6-15 IE3	C	S	NO	1,00	51,2%	51,2	11,09	61349	34,01	972
HTMH-125-6T/9-7,5	C	S	NO	1,00	57,2%	58,8	5,67	36967	32,26	973
HTMH-125-6T/9-10 IE3	C	S	NO	1,00	55,1%	56,2	6,74	48390	28,19	976
HTMH-125-6T/9-15 IE3	C	S	NO	1,00	50,9%	50,9	11,00	61885	33,25	973
HTMH-125-6T/9-20 IE3	C	S	NO	1,01	49,7%	49,5	15,00	69606	39,35	968
HTMH-125-8T/6-4	C	S	NO	1,00	47,4%	50,3	3,53	38680	15,89	709
HTMH-125-8T/6-5,5	C	S	NO	1,00	46,8%	49,1	4,42	42659	17,80	715
HTMH-125-8T/6-7,5	C	S	NO	1,00	45,5%	47,0	5,87	50667	19,37	727
HTMH-125-8T/6-10	B	T	NO	1,00	65,4%	66,1	7,79	65294	28,66	727
HTMH-125-8T/9-5,5	C	S	NO	1,00	44,6%	46,7	4,79	43462	18,07	712
HTMH-125-8T/9-7,5	C	S	NO	1,00	46,5%	48,0	5,75	48507	20,26	728
HTMH-125-8T/9-10	C	S	NO	1,00	45,9%	46,7	7,65	55731	23,16	728
HTMH-125-8T/9-15	B	T	NO	1,00	67,6%	67,6	10,90	72088	37,51	728

Datos del punto de máxima eficiencia del ventilador interno

**Dimensiones mm**

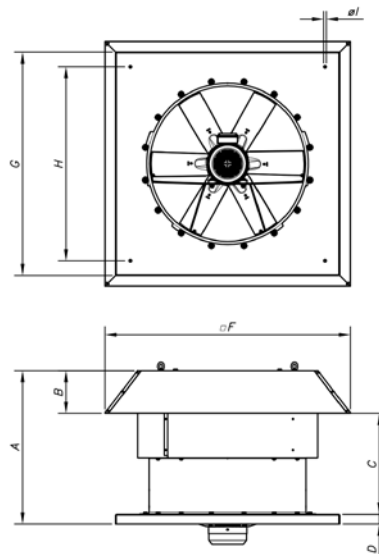

Modelo	A	B	C	D	F	G	H	I
HTMH-56	650	185	465	40	960	900	750	14
HTMH-63	680	215	465	40	1092	1000	850	14
HTMH-71	760	195	565	40	1120	1000	850	14
HTMH-80	790	215	575	50	1252	1150	1000	14
HTMH-90	910	232	678	50	1380	1150	1000	14
HTMH-100	1055	252	803	50	1527	1250	1100	14
HTMH-125	1170	310	859	50	1802	1600	1450	17

**Curvas características**

Q= Caudal en m<sup>3</sup>/h, m<sup>3</sup>/s y cfm.

Pe= Presión estática en mmH<sub>2</sub>O, Pa e inwg.

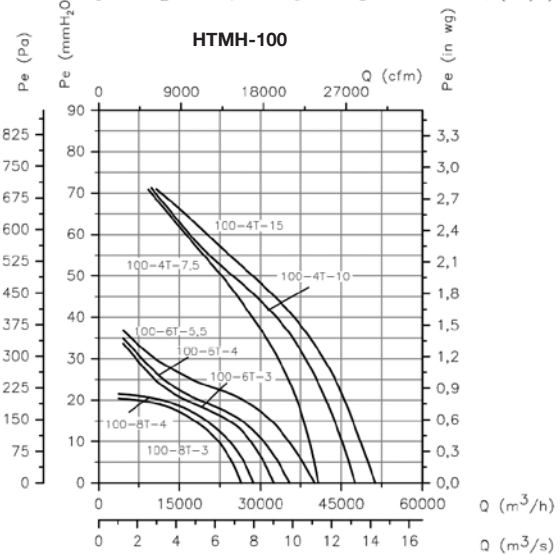
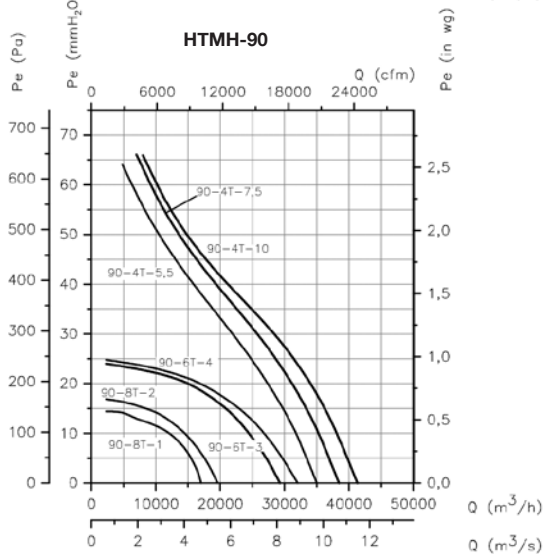
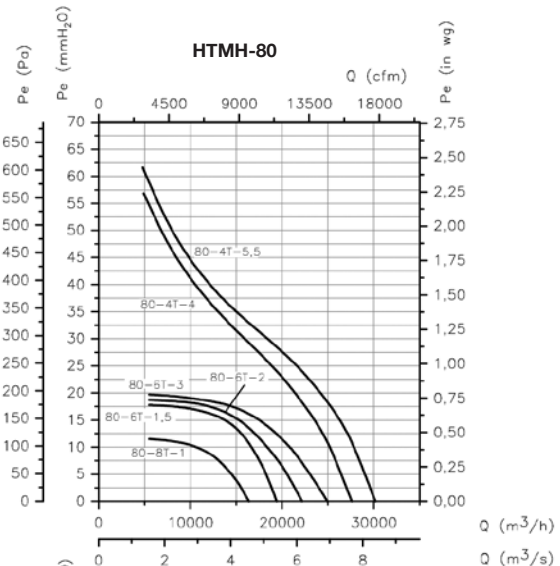
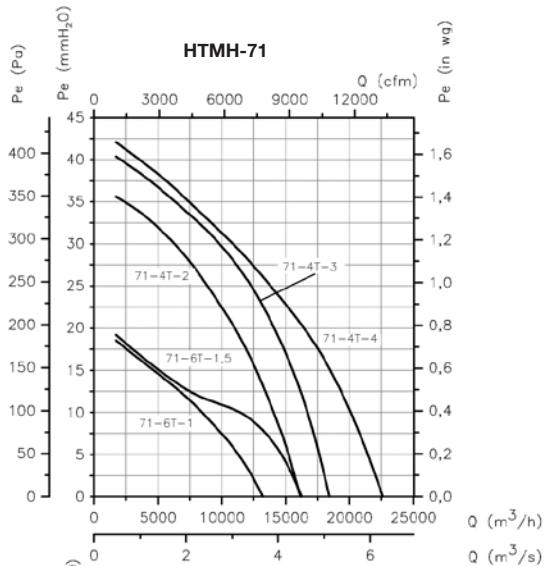
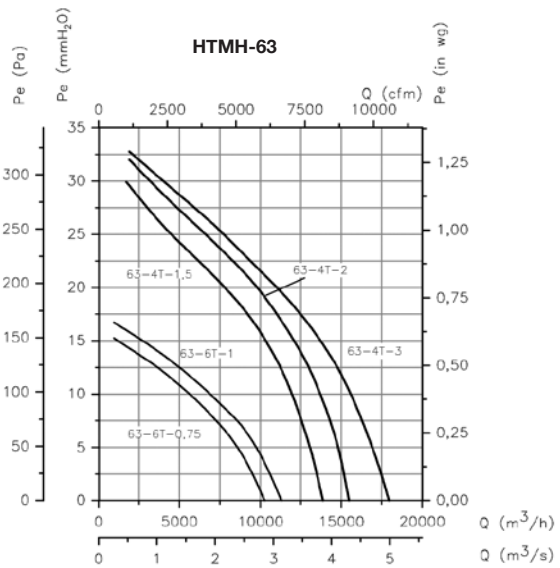
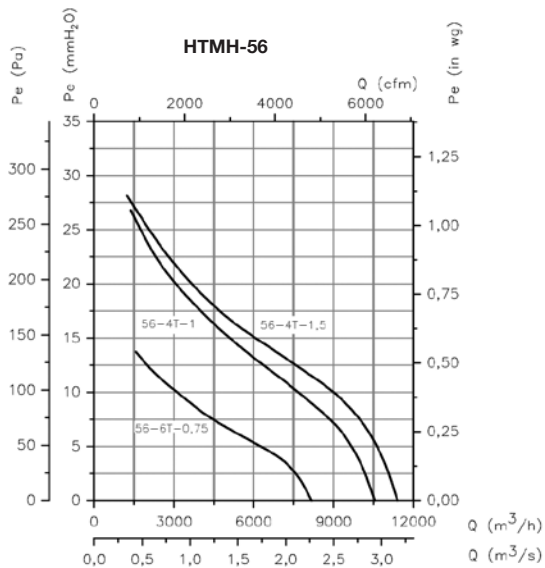

**Curvas características**

Q= Caudal en m<sup>3</sup>/h, m<sup>3</sup>/s y cfm.

Pe= Presión estática en mmH<sub>2</sub>O, Pa e inwg.

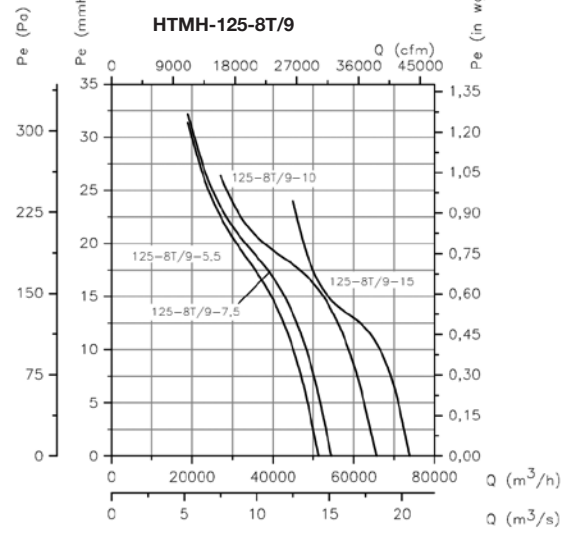
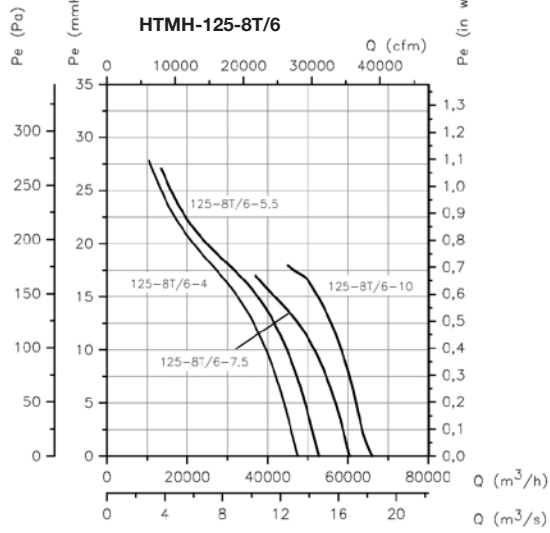
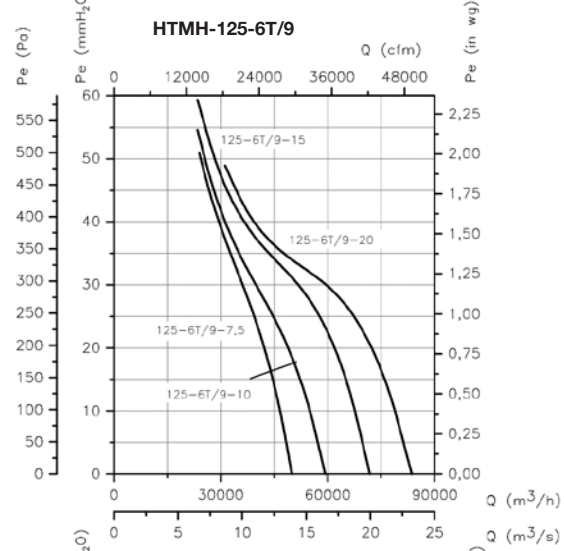
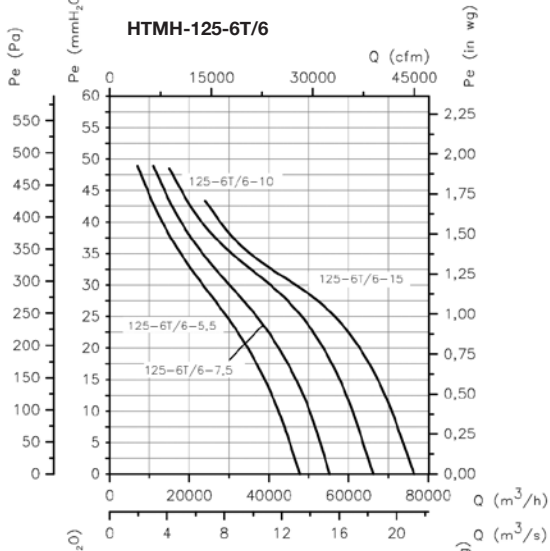
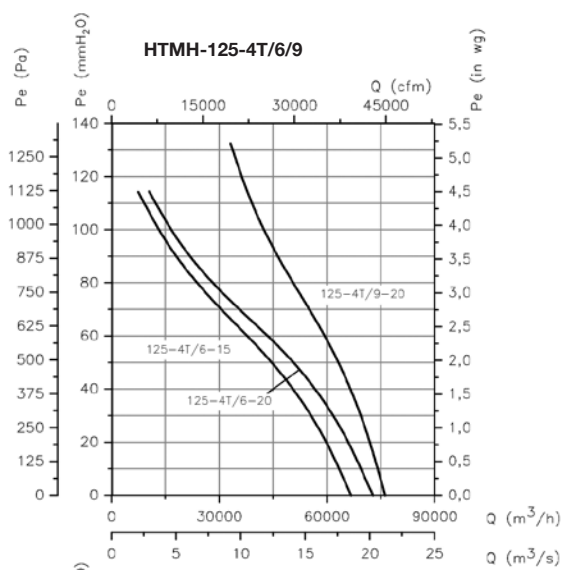
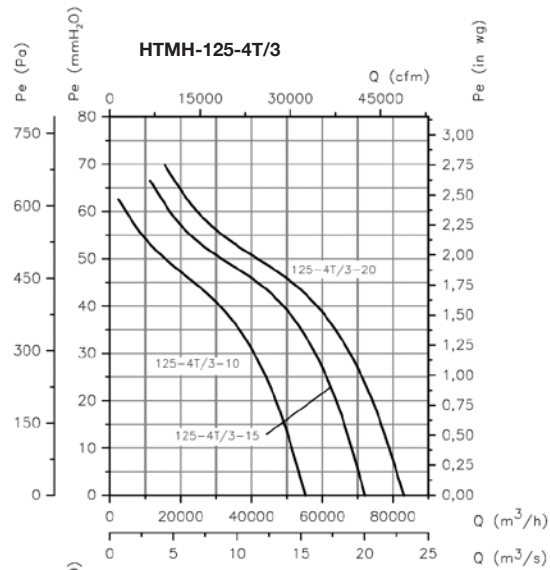



**Validación de la presión sonora según distancia**

El nivel sonoro puede variar dependiendo de la estructura de la cubierta o tejado.

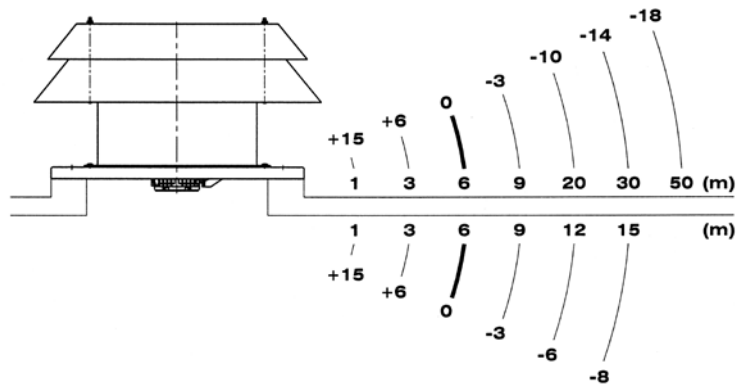

**Accesorios**

Ver apartado accesorios



# EXTRACTORES PARA: **ATMÓSFERAS EXPLOSIVAS ATEX**



<p><b>HCDF</b></p>  <p>Extractores helicoidales con marco cuadrado, con Certificación ATEX Ex d</p> <p>131</p>	<p><b>HDF</b></p>  <p>Extractores helicoidales con marco circular, con Certificación ATEX Ex d</p> <p>131</p>	<p><b>HC/ATEX</b></p>  <p>Extractores helicoidales murales, con Certificación ATEX y posible marcado Ex e, EX d, Ex tc y Ex tb</p> <p>134</p>	<p><b>HCH/ATEX</b></p>  <p>Extractores helicoidales murales de gran robustez, con Certificación ATEX</p> <p>140</p>
<p><b>HCT/ATEX</b></p>  <p>Extractores helicoidales tubulares de gran robustez, con Certificación ATEX</p> <p>140</p>	<p><b>HTM/ATEX</b></p>  <p>Extractores tubulares móviles, con Certificación ATEX</p> <p>147</p>	<p><b>HPX/ATEX</b></p>  <p>Extractores helicoidales tubulares, con motor exterior y Certificación ATEX</p> <p>149</p>	<p><b>CPV/ATEX</b></p>  <p>Extractores centrífugos anticorrosivos en material plástico, con certificación ATEX</p> <p>152</p>
<p><b>CMA/ATEX</b></p>  <p>Extractores centrífugos de media presión en fundición de aluminio, con certificación ATEX</p> <p>155</p>	<p><b>CMP/ATEX</b></p>  <p>Extractores centrífugos de media presión equipados con turbina multipala, con certificación ATEX</p> <p>158</p>	<p><b>CMP/AL CJMP/AL</b></p>  <p>Ventiladores en aluminio con certificado para salas de calderas de gas natural</p> <p>166</p>	<p><b>CMR/ATEX</b></p>  <p>Extractores centrífugos de media presión y gran robustez, equipados con turbina a reacción, con certificación ATEX</p> <p>168</p>
<p><b>CAS/ATEX</b></p>  <p>Extractores centrífugos de alta presión y simple aspiración, con certificación ATEX</p> <p>171</p>	<p><b>CA/ATEX</b></p>  <p>Extractores centrífugos de alta presión y simple aspiración en fundición de aluminio, con certificación ATEX</p> <p>176</p>	<p><b>HT/ATEX</b></p>  <p>Extractores helicoidales de tejado, con Certificación ATEX y posible marcado Ex e, Ex d, Ex tc y Ex tb</p> <p>179</p>	<p><b>RFHD</b></p>  <p>Extractores centrífugos de tejado con salida horizontal y certificación ATEX Ex d</p> <p>182</p>
<p><b>CVT/ATEX CHT/ATEX</b></p>  <p>Extractores centrífugos de tejado con salida horizontal o vertical, con Certificación ATEX</p> <p>186</p>	<p><b>KIT SOBREPRESIÓN</b></p>  <p>190</p>		

# HCDF HDF

**HCDF: Extractores helicoidales con marco cuadrado, con Certificación ATEX Ex d**  
**HDF: Extractores helicoidales con marco circular, con Certificación ATEX Ex d**

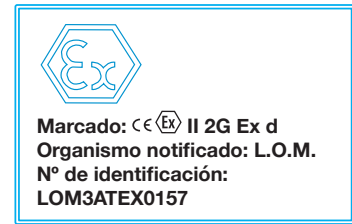

Extractores helicoidales murales (HCDF) o circulares (HDF) con Certificación ATEX y motor antideflagrante CEE ExII2G Ex d, para trabajar en atmósferas explosivas.

**Ventilador:**

- Hélice en fundición de aluminio
- Dirección aire motor-hélice
- Prensaestopas antideflagrante incluido
- HCDF: Marco soporte en chapa de acero, con banda de aluminio en la zona de la hélice según norma EN-14986:2007
- HCDF: Rejilla de protección contra contactos según norma UNE-EN ISO 12499:2010
- HDF: Aro soporte en chapa de acero, con banda de aluminio en la zona de la hélice según norma EN-14986:2007

**Motor:**

- Motores clase F, con rodamientos a bolas, protección IP55, con certificación ATEX, antideflagrantes Ex"d" IIBT4
- Trifásicos 230/400V.-50Hz.(hasta 4 kW) y 400/690V.-50Hz. (potencias superiores a 4 kW)
- HDF: Temperatura de trabajo: -20°C.+ 40°C.
- HCDF: Temperatura de trabajo: -20°C +50 °C

**Acabado:**

- Anticorrosivo con pintura ATEX, libre de componentes férricos, en resina de poliéster polimerizada a 190 °C, previo desengrase con tratamiento nanotecnológico libre de fosfatos

**Bajo demanda:**

- Bobinados especiales para diferentes tensiones y frecuencias
- Construcción ATEX para diferentes categorías
- Extractores con motor de 2 velocidades



Banda de aluminio para prevenir chispas según norma EN-14986:2007

**Código de pedido**



HCDF: Extractores helicoidales con marco cuadrado, con Certificación ATEX  
 HDF: Extractores helicoidales con marco circular, con Certificación ATEX

Diámetro de la hélice (cm)

Número de polos motor  
 4=1400 r/min. 50 Hz  
 6=900 r/min. 50 Hz

T=Trifásico  
 M=Monofásico

Marcado:  $\text{CE} \text{ (Ex) II 2G c}$

**Características técnicas**

Modelo	Velocidad (r/min)	Intensidad máxima admisible (A)		Potencia instalada (kW)	Caudal máximo (m³/h)	Nivel presión sonora dB(A)	Peso aprox. (Kg)
		230V	400V				
HCDF-25-4T	1360	0,78	0,45	0,09	890	51	6,5
HCDF-25-4M	1235	1,00		0,06	890	51	6,5
HCDF-31-4T	1360	0,78	0,45	0,09	1700	54	7,5
HCDF-31-4M	1235	1,00		0,06	1700	54	7,5
HCDF-35-4T	1360	0,78	0,45	0,09	2950	58	8,5
HCDF-35-4M	1235	1,00		0,06	2950	58	8,5
HCDF-40-4T	1370	2,08	1,20	0,25	4400	63	12,5
HCDF-40-4M	1385	2,04		0,25	4400	63	15,0
HCDF-45-4T	1370	2,08	1,20	0,25	6450	66	14,5
HCDF-45-4M	1385	2,04		0,25	6450	66	17,0
HCDF-45-6T	900	1,39	0,80	0,12	5200	57	14,5
HCDF-50-4T	1370	2,60	1,50	0,37	8600	69	16,5
HCDF-56-4T	1410	2,94	1,70	0,55	10500	72	36,5
HCDF-56-6T	910	2,42	1,40	0,25	8400	63	30,5
HDF-63-4T	1410	5,20	3,00	1,10	15100	76	49,0
HDF-63-6T	935	2,77	1,60	0,37	12400	64	36,5
HDF-71-4T	1410	5,20	3,00	1,10	20000	79	52,0
HDF-71-6T	930	3,46	2,00	0,55	13800	67	43,0
HDF-80-4T	1440	12,30	7,10	3,00	34100	83	76,0
HDF-80-6T	910	5,89	3,40	1,10	20200	72	65,5
HDF-90-4T	1450	15,76	9,10	4,00	48200	89	87,0
HDF-90-6T	940	7,62	4,40	1,50	30000	77	83,0

**Características acústicas**

Los valores indicados, se determinan mediante medidas de nivel de presión y potencia sonora en dB(A) obtenidas en campo libre a una distancia equivalente a dos veces la envergadura del ventilador más el diámetro de la hélice, con un mínimo de 1,5 mts.

Espectro de potencia sonora Lw(A) en dB(A) banda de frecuencia en [Hz]

Modelo	63	125	250	500	1000	2000	4000	8000	Modelo	63	125	250	500	1000	2000	4000	8000
25	22	37	56	55	56	55	50	41	63-4	52	66	85	85	86	84	80	71
31	25	40	59	58	59	58	53	44	63-6	40	54	73	73	74	72	68	59
35	29	44	63	62	63	62	57	48	71-4	56	76	84	89	91	88	81	70
40	34	49	68	67	68	67	62	53	71-6	44	64	72	77	79	76	69	58
45-4	37	52	71	70	71	70	65	56	80-4	60	80	88	93	95	92	85	74
45-6	28	43	62	61	62	61	56	47	80-6	49	69	77	82	84	81	74	63
50-4	43	57	76	76	77	75	71	62	90-4	67	88	95	100	103	99	92	81
56-4	46	60	79	79	80	78	74	65	90-6	55	76	83	88	91	87	80	69
56-6	37	51	70	70	71	69	65	56									

**Dimensiones mm**

HCDF 25...50

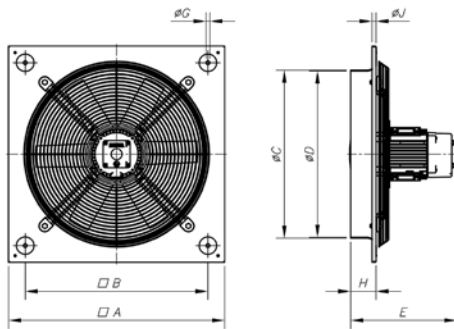

HCDF 56

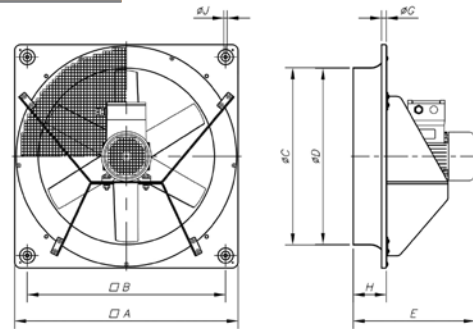

Modelo	A	B	ØC	ØD	E	G	H	ØI	ØJ
HCDF-25-4T	330	275	262	260	275	11	56	110	8,5
HCDF-25-4M	330	275	262	260	275	11	56	110	8,5
HCDF-31-4T	400	336	310,5	308	285	11	65	110	10,5
HCDF-31-4M	400	336	310,5	308	285	11	65	110	10,5
HCDF-35-4T	465	390	362,5	360	296	11	76	110	10,5
HCDF-35-4M	465	390	362,5	360	296	11	76	110	10,5
HCDF-40-4T	532	452	412,5	410	335	11	98	136	10,5
HCDF-40-4M	532	452	412,5	410	335	11	98	136	10,5
HCDF-45-4T	596	504	462,5	460	331	11	105	136	10,5
HCDF-45-4M	596	504	462,5	460	331	11	105	136	10,5
HCDF-45-6T	596	504	462,5	460	338	11	105	136	10,5
HCDF-50-4T	665	562	516,5	514	345	11	115	136	10,5
HCDF-56-4T	710	630	563	560	397	15	115	-	10,5
HCDF-56-6T	710	630	563	560	386	15	115	-	10,5

HDF

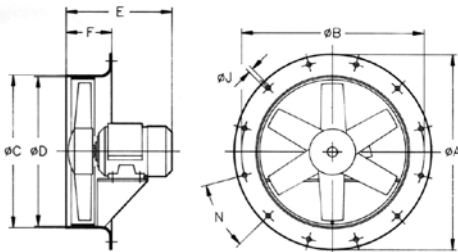

Modelo	ØA	ØB	ØC	D	E	F	ØJ	N
HDF-63-4T	730	690	645	640	370	150	12	12x30°
HDF-63-6T	730	690	645	640	330	150	12	12x30°
HDF-71-4T	810	770	715	710	349	150	12	16x22°30'
HDF-71-6T	810	770	715	710	323	150	12	16x22°30'
HDF-80-4T	900	860	805	800	421	180	12	16x22°30'
HDF-80-6T	900	860	805	800	371	180	12	16x22°30'
HDF-90-4T	1015	970	906	900	457	180	15	16x22°30'
HDF-90-6T	1015	970	906	900	415	180	15	16x22°30'

**Curvas características**

Q= Caudal en m<sup>3</sup>/h, m<sup>3</sup>/s y cfm.

Pe= Presión estática en mmH<sub>2</sub>O, Pa e inwg.

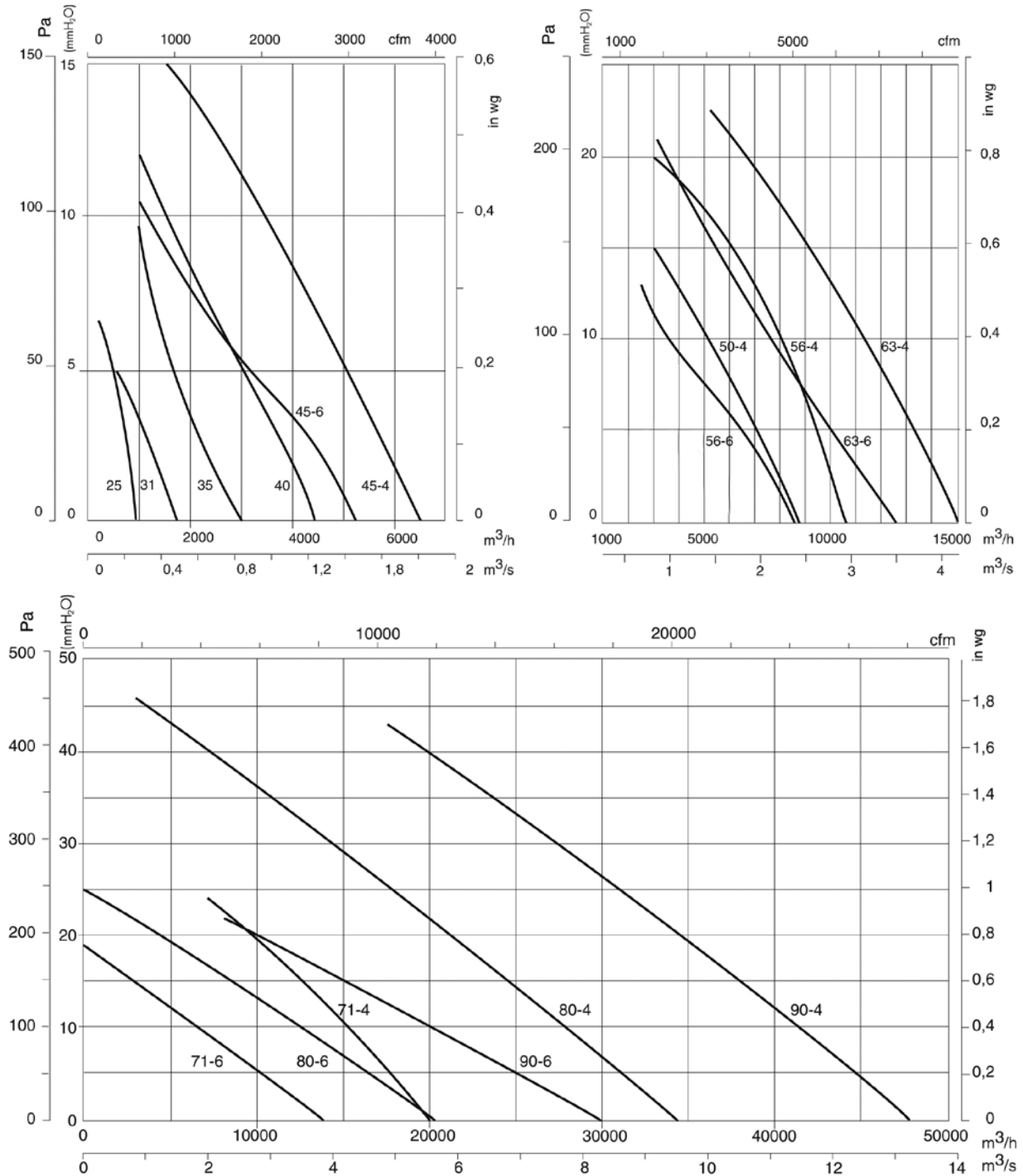

**Accesorios**

Ver apartado accesorios.



# HC/ATEX *Extractores helicoidales murales, con Certificación ATEX y posible marcado Ex e, Ex d, Ex tc y Ex tb*



HC-25...63



HC-71...100

Extractores helicoidales murales y Certificación ATEX con motor antiexplosivo CEE ExII2G Ex e, antideflagrante CEE ExII2G Ex d, Ex tc, o Ex tb para trabajar en atmósferas explosivas de gas o polvo.

**Ventilador:**

- Hélice en fundición de aluminio
- Dirección aire motor-hélice
- Prensaestopas antichispas incluido
- Rejilla de protección contra contactos según norma UNE-EN ISO 12499:2010 incluida en modelos 25 a 63, resto de modelos como accesorio.
- Marco soporte en chapa de acero, con banda de aluminio en la zona de la hélice según norma EN-14986:2007

**Motor:**

- Motores clase F, con rodamientos a bolas con certificación ATEX, antiexplosivos Ex e, antideflagrante Ex d, Ex tc, o Ex tb
- Trifásicos 230/400V.-50Hz.(hasta 4 kW) y 400/690V.-50Hz.(potencias superiores a 4 kW)
- Temperatura de trabajo: -20°C.+ 40°C.

**Ex "e" marcado:** CEE Ex II 2G Ex e  
**Ex "d" marcado:** CEE Ex II 2G Ex d  
**Ex tc marcado:** CEE Ex II 3D Ex tc  
**Ex tb marcado:** CEE Ex II 2D Ex tb  
**Organismo notificado:** L.O.M.  
**Nº de identificación:** LOM3ATEX0157

**Acabado:**

- Anticorrosivo con pintura ATEX, libre de componentes férricos, en resina de poliéster polimerizada a 190 °C, previo desengrase con tratamiento nanotecnológico libre de fosfatos.

**Bajo demanda:**

- Motores con PTC incorporada
- Bobinados especiales para diferentes tensiones y frecuencias
- Construcción ATEX para diferentes categorías
- Extractores con motor de 2 velocidades
- Motores monofásicos antideflagrantes Ex d

**Código de pedido**

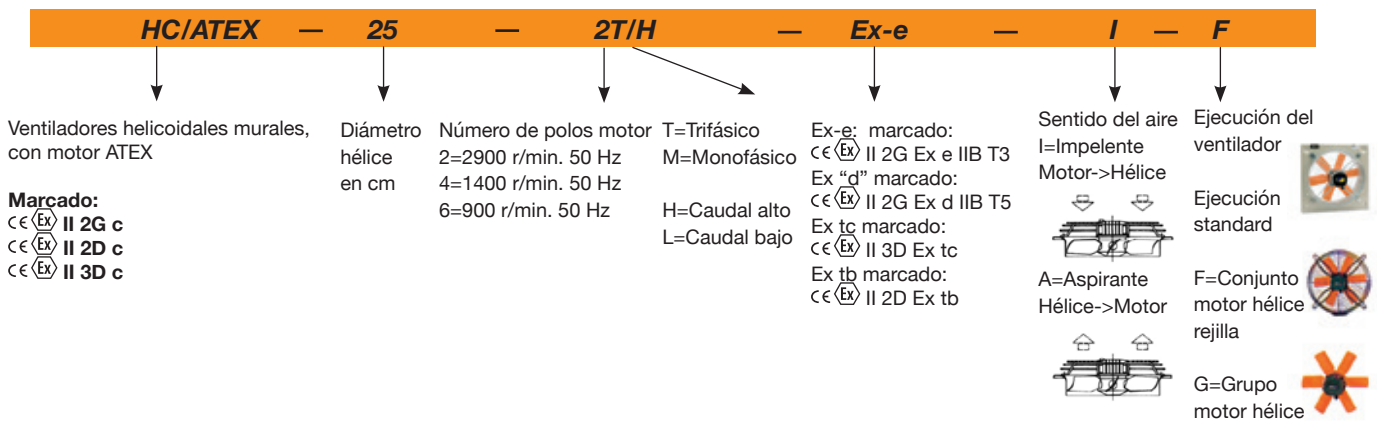

**Características técnicas**

Modelo	Velocidad (r/min)	Intensidad máxima admisible (A)			Potencia instalada (kW)	Caudal máximo (m³/h)	Nivel presión sonora dB(A)
		230V	400V	690V			
HC/ATEX-25-2T/H	2730	0,74	0,43		0,12	2200	64
HC/ATEX-25-4T/H	1400	1,28	0,74		0,12	1300	51
HC/ATEX-31-2T/H	2760	1,21	0,70		0,18	3650	72
HC/ATEX-31-4T/H	1400	1,28	0,74		0,12	2400	54
HC/ATEX-31-4T/L	1320	0,65	0,38		0,09	1800	52
HC/ATEX-35-2T/H	2770	2,08	1,20		0,37	6050	76
HC/ATEX-35-4T/H	1400	1,28	0,74		0,12	3550	58
HC/ATEX-35-4T/L	1400	1,28	0,74		0,12	2600	56
HC/ATEX-40-4T/H	1370	2,08	1,20		0,25	5200	63
HC/ATEX-40-4T/L	1400	1,28	0,74		0,12	4050	59
HC/ATEX-40-6T/H	910	2,42	1,40		0,25	3700	55
HC/ATEX-45-4T/H	1370	2,60	1,50		0,37	7300	66
HC/ATEX-45-4T/L	1370	2,08	1,20		0,25	5600	63
HC/ATEX-45-6T/H	910	2,42	1,40		0,25	5150	57
HC/ATEX-50-4T/H	1410	2,94	1,70		0,55	10200	69
HC/ATEX-50-4T/L	1370	2,08	1,20		0,25	7400	66

Características técnicas

Modelo	Velocidad (r/min)	Intensidad máxima admisible (A)			Potencia instalada (kW)	Caudal máximo (m³/h)	Nivel presión sonora dB(A)
		230V	400V	690V			
HC/ATEX-50-6T/H	935	2,77	1,60		0,37	6300	59
HC/ATEX-56-4T/H	1410	5,20	3,00		1,10	13000	72
HC/ATEX-56-4T/L	1410	2,94	1,70		0,55	11050	70
HC/ATEX-56-6T/H	935	2,77	1,60		0,37	8300	61
HC/ATEX-63-4T/H	1410	5,20	3,00		1,10	16450	74
HC/ATEX-63-4T/L	1410	3,81	2,20		0,75	14400	73
HC/ATEX-63-6T/H	935	2,77	1,60		0,37	12350	64
HC/ATEX-71-4T/H	1400	6,93	4,00		1,50	22150	78
HC/ATEX-71-6T/H	930	4,16	2,40		0,75	17300	66
HC/ATEX-80-4T/H	1440	12,30	7,10		3,00	33000	82
HC/ATEX-80-4T/L	1400	6,93	4,00		1,50	25000	79
HC/ATEX-80-6T/H	930	4,16	2,40		0,75	22000	71
HC/ATEX-80-6T/L	930	3,46	2,00		0,55	19200	70
HC/ATEX-90-4T/H	1450	15,76	9,10		4,00	43700	86
HC/ATEX-90-4T/L	1440	12,30	7,10		3,00	33700	83
HC/ATEX-90-6T/H	940	7,62	4,40		1,50	33300	76
HC/ATEX-90-6T/L	910	5,89	3,40		1,10	26550	73
HC/ATEX-100-4T/H	1440		12,00	6,93	5,50	54000	88
HC/ATEX-100-4T/L	1450	15,76	9,10		4,00	42750	84
HC/ATEX-100-6T/H	940	7,62	4,40		1,50	37000	78
HC/ATEX-100-6T/L	910	5,89	3,40		1,10	29000	76

Dimensiones mm

**HC/ATEX 25...63**

**HC/ATEX 71...100**

Modelo	∅A	∅B	∅C	∅D	E	G	H	∅J	K
HC-25	330	275	262	260	236,5	11	56	8,5	310
HC-31-2	400	336	310,5	308	264,5	11	65	10,5	380
HC-31-4	400	336	310,5	308	245,5	11	65	10,5	380
HC-35-2	465	390	362,5	360	275,5	11	76	10,5	450
HC-35-4	465	390	362,5	360	256,5	11	76	10,5	450
HC-40-4.../H	532	452	412,5	410	297,5	11	97,5	10,5	500
HC-40-4.../L	532	452	412,5	410	278,5	11	97,5	10,5	500
HC-40-6.../H	532	452	412,5	410	308,5	11	97,5	10,5	500
HC-45-4.../H	596	504	462,5	460	315,5	11	105	10,5	560
HC-45-4.../L	596	504	462,5	460	304,5	11	105	10,5	560
HC-45-6.../H	596	504	462,5	460	315,5	11	105	10,5	560
HC-50-4T/H	665	562	516,5	514	325,5	11	115	10,5	640
HC-50-4.../L	665	562	516,5	514	283,5	11	115	10,5	640
HC-50-6.../H	665	562	516,5	514	351	11	115	10,5	640
HC-56-4T/H	710	630	563	560	374	15	115	10,5	721
HC-56-4T/L	710	630	563	560	325,5	15	115	10,5	721
HC-56-6.../H	710	630	563	560	351	15	115	10,5	721
HC-63-4T/H	800	710	638	635	399	15	140	10,5	820
HC-63-4.../L	800	710	638	635	376	15	140	10,5	820
HC-63-6.../H	800	710	638	635	376	15	140	10,5	820

Modelo	∅A	∅B	∅C	∅D	E	G	H	∅J
HC-71-4T/H	850	810	715	711	395	20	170	14,5
HC-71-6T/H	850	810	715	711	395	20	170	14,5
HC-80-4T/H	970	910	801	797	488	20	210	14,5
HC-80-4T/L	970	910	801	797	458	20	210	14,5
HC-80-6T/H	970	910	801	797	458	20	210	14,5
HC-80-6T/L	970	910	801	797	416	20	210	14,5
HC-90-4T/H	1170	1110	918	914	511	20	210	14,5
HC-90-4T/L	1170	1110	918	914	488	20	210	14,5
HC-90-6T/H	1170	1110	918	914	488	20	210	14,5
HC-90-6T/L	1170	1110	918	914	455	20	210	14,5
HC-100-4T/H	1170	1110	1003	999	548	20	220	14,5
HC-100-4T/L	1170	1110	1003	999	521	20	220	14,5
HC-100-6T/H	1170	1110	1003	999	498	20	220	14,5
HC-100-6T/L	1170	1110	1003	999	468	20	220	14,5

Las medidas corresponden a la versión Ex "e"

Las medidas corresponden a la versión Ex "e"

**Características acústicas**

Los valores indicados, se determinan mediante medidas de nivel de presión y potencia sonora en dB(A) obtenidas en campo libre a una distancia equivalente a dos veces la envergadura del ventilador más el diámetro de la hélice, con un mínimo de 1.5 mts.

Espectro de potencia sonora Lw(A) en dB(A) por banda de frecuencia en Hz

Modelo	63	125	250	500	1000	2000	4000	8000	Modelo	63	125	250	500	1000	2000	4000	8000
25-2/H	38	48	65	65	73	69	62	53	56-4/L	43	58	68	73	79	80	76	69
25-4/H	25	35	52	52	60	56	49	40	63-4/H	43	60	73	80	85	86	81	74
31-2/H	46	56	73	73	81	77	70	61	63-6/H	33	50	63	70	75	76	71	64
31-4/H	28	38	55	55	63	59	52	43	63-4/L	48	63	73	78	84	85	81	74
31-4/L	26	36	53	53	61	57	50	41	71-4/H	47	64	77	84	89	90	85	78
35-2/H	50	60	77	77	85	81	74	65	71-6T/H	35	52	65	72	77	78	73	66
35-4/H	32	42	59	59	67	63	56	47	80-4/H	60	81	88	93	96	92	85	74
35-4/L	30	40	57	57	65	61	54	45	80-6/H	49	70	77	82	85	81	74	63
40-4/H	28	45	57	65	70	70	66	59	80-4/L	57	78	85	90	93	89	82	71
40-4/L	29	45	55	59	66	66	62	55	80-6/L	48	69	76	81	84	80	73	62
40-6/H	20	37	49	57	62	62	58	51	90-4/H	64	85	92	97	100	96	89	78
45-4/H	33	50	63	70	75	76	71	64	90-6/H	54	75	82	87	90	86	79	68
45-4/L	36	51	61	66	72	73	69	62	90-4/L	61	82	89	94	97	93	86	75
45-6/H	24	41	54	61	66	67	62	55	90-6/L	51	72	79	84	87	83	76	65
50-4/H	36	53	66	73	78	79	74	67	100-4/H	68	88	96	101	103	100	93	82
50-4/L	39	54	64	69	75	76	72	65	100-6/H	58	78	86	91	93	90	83	72
50-6/H	26	43	56	63	68	69	64	57	100-4/L	64	84	92	97	99	96	89	78
56-4/H	39	56	69	76	81	82	77	70	100-6/L	56	76	84	89	91	88	81	70
56-6/H	28	45	58	65	70	71	66	59									

**Curvas características**

Q= Caudal en m³/h, m³/s y cfm.

Pe= Presión estática en mmH2O, Pa e inwg.

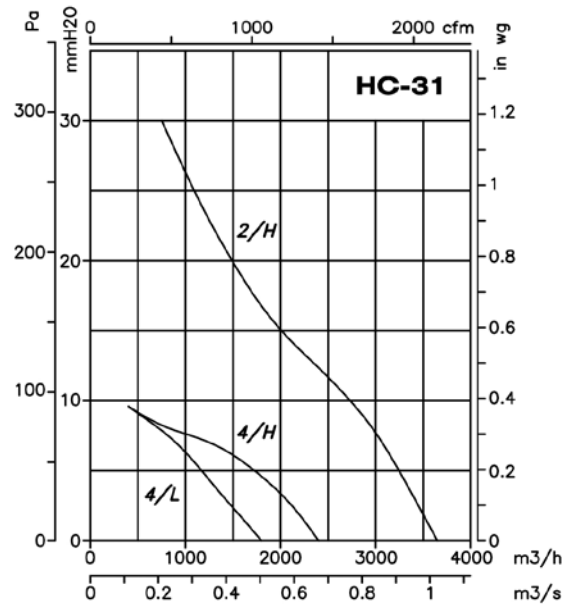
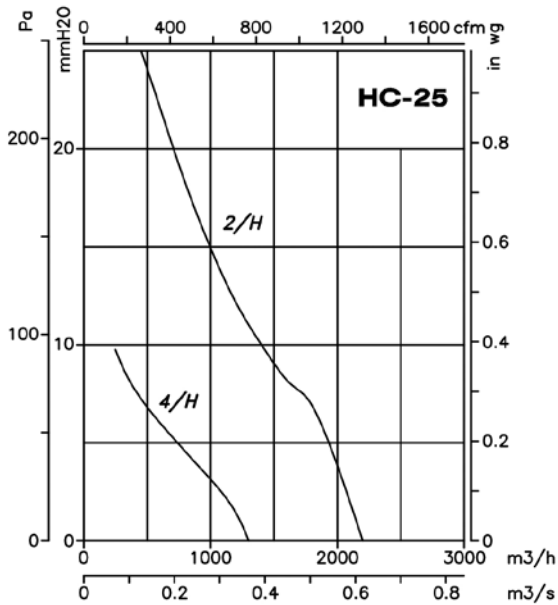



**Curvas características**

Q= Caudal en m<sup>3</sup>/h, m<sup>3</sup>/s y cfm.

Pe= Presión estática en mmH<sub>2</sub>O, Pa e in.wg.

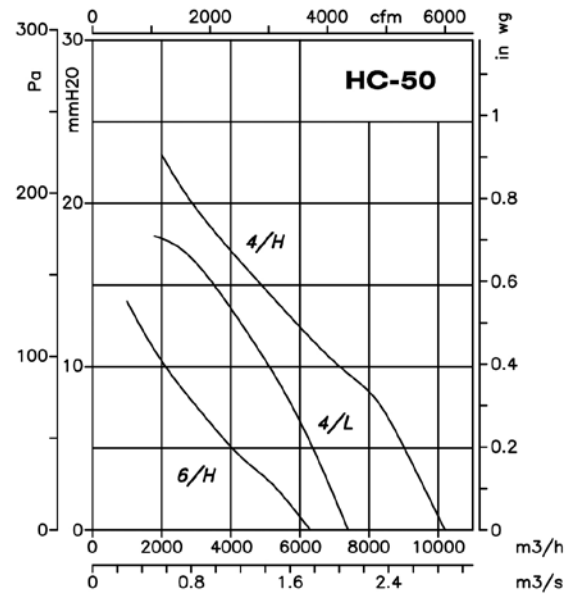
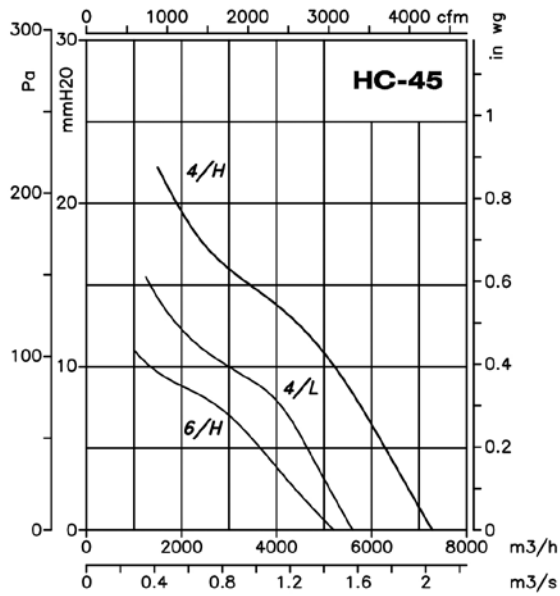
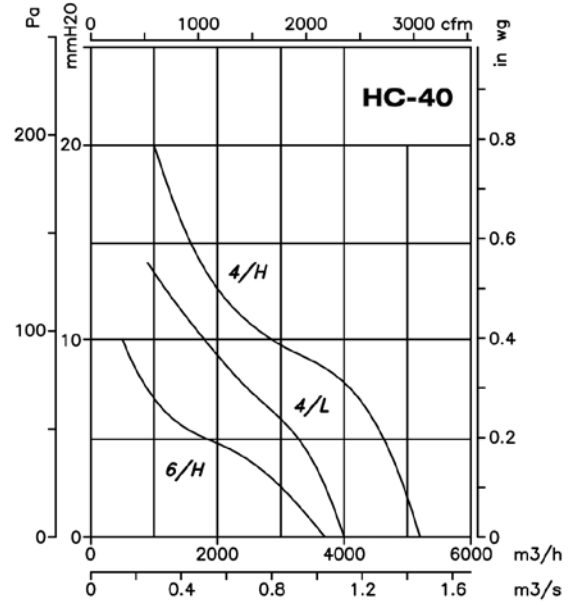
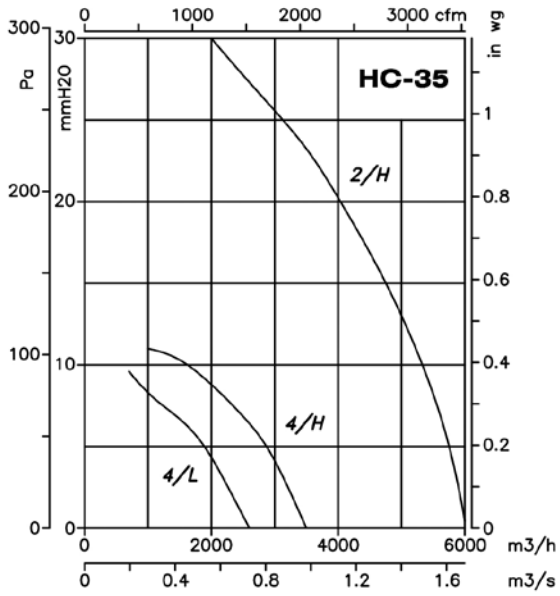

**Curvas características**

Q= Caudal en m³/h, m³/s y cfm.

Pe= Presión estática en mmH2O, Pa e in wg.

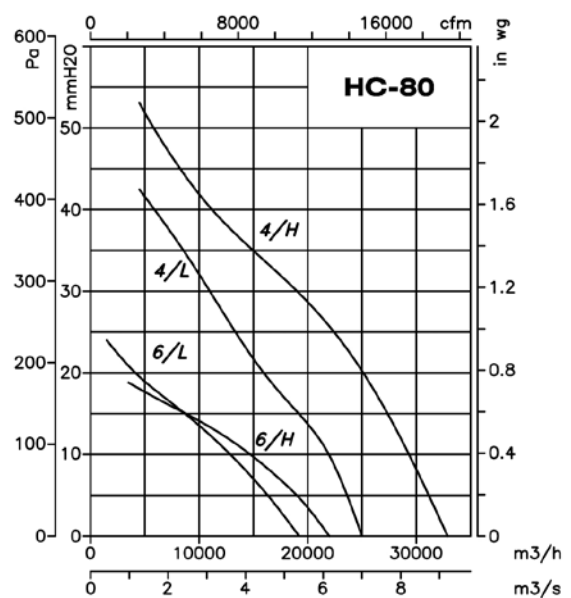
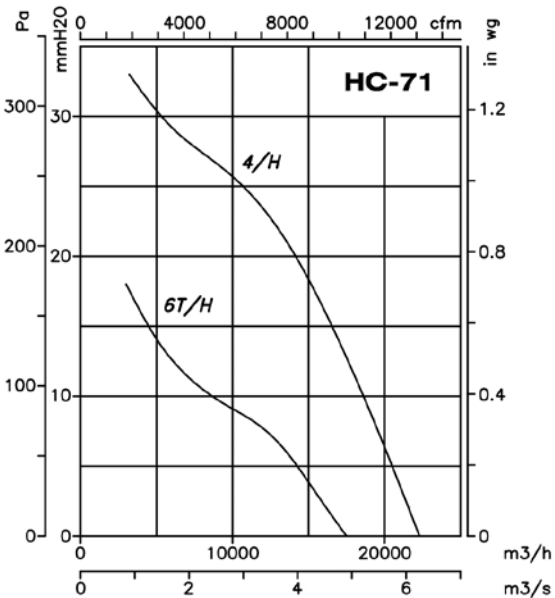
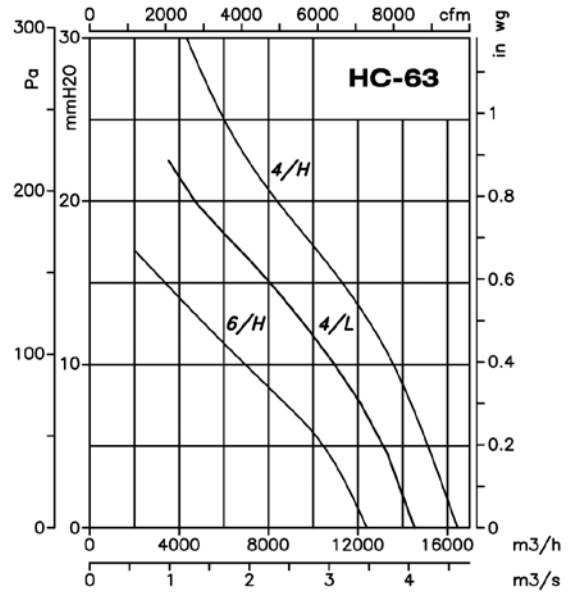
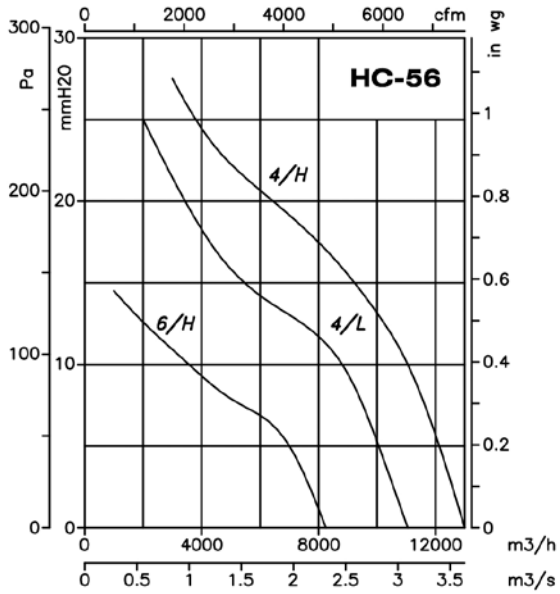

**Curvas características**

Q= Caudal en m<sup>3</sup>/h, m<sup>3</sup>/s y cfm.

Pe= Presión estática en mmH<sub>2</sub>O, Pa e inwg.

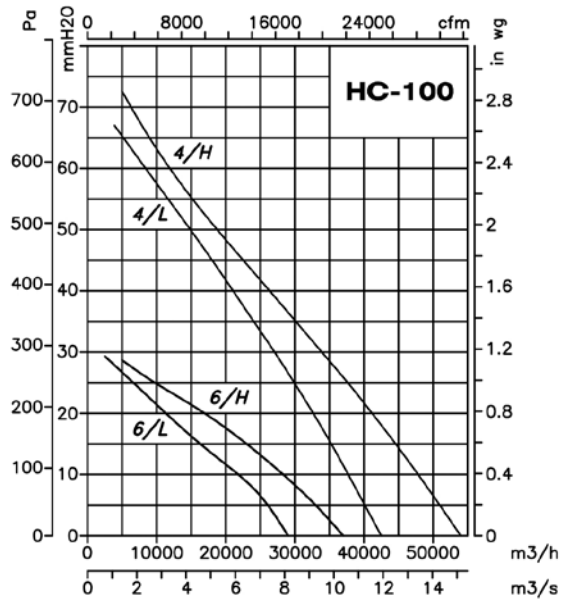
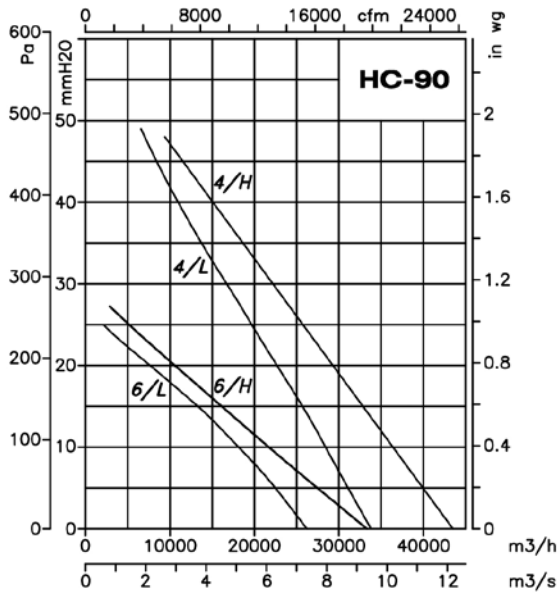

**Accesorios**

Ver apartado accesorios.



# HCH/ATEX HCT/ATEX

**HCH/ATEX: Extractores helicoidales murales de gran robustez, con Certificación ATEX**  
**HCT/ATEX: Extractores helicoidales tubulares de gran robustez, con Certificación ATEX**

Ex "e" marcado:  $\text{CE} \text{Ex} \text{II} 2\text{G} \text{Ex} \text{e}$   
 Ex "d" marcado:  $\text{CE} \text{Ex} \text{II} 2\text{G} \text{Ex} \text{d}$   
 Ex tc marcado:  $\text{CE} \text{Ex} \text{II} 3\text{D} \text{Ex} \text{tc}$   
 Ex tb marcado:  $\text{CE} \text{Ex} \text{II} 2\text{D} \text{Ex} \text{tb}$   
**Organismo notificado: L.O.M.**  
**Nº de identificación: LOM3ATEX0157**



HCH/ATEX



HCT/ATEX

Extractores helicoidales circulares (HCH) o tubulares (HCT), y Certificación ATEX con motor antiexplosivo CEE ExII2G Ex e, antideflagrante CEE ExII2G Ex d, Ex tc, o Ex tb para trabajar en atmósferas explosivas.

**Ventilador:**

- HCH/ATEX: Aro soporte en chapa de acero, con banda de aluminio en la zona de la hélice según norma EN-14986:2007
- HCT/ATEX: Envoltente tubular en chapa de acero, con banda de aluminio en la zona de la hélice según norma EN-14986:2007
- Hélice en fundición de aluminio
- Incorpora trampilla de inspección (HCT)
- Dirección aire motor-hélice

**Motor:**

- Motores clase F, con rodamientos a bolas con certificación ATEX, antiexplosivos Ex e, antideflagrante Ex d, Ex tc, o Ex tb
- Trifásicos 230/400V.-50Hz.(hasta 4 kW) y 400/690V.-50Hz. (potencias superiores a 4 kW)
- Temperatura de trabajo: -20°C.+ 40°C.

**Acabado:**

- Anticorrosivo con pintura ATEX, libre de componentes férricos, en resina de poliéster polimerizada a 190 °C, previo desengrase con tratamiento nanotecnológico libre de fosfatos

**Bajo demanda:**

- Motores con PTC incorporada
- Bobinados especiales para diferentes tensiones y frecuencias
- Construcción ATEX para diferentes categorías
- Extractores con motor de 2 velocidades
- Motores monofásicos antideflagrantes Ex d

**Código de pedido**

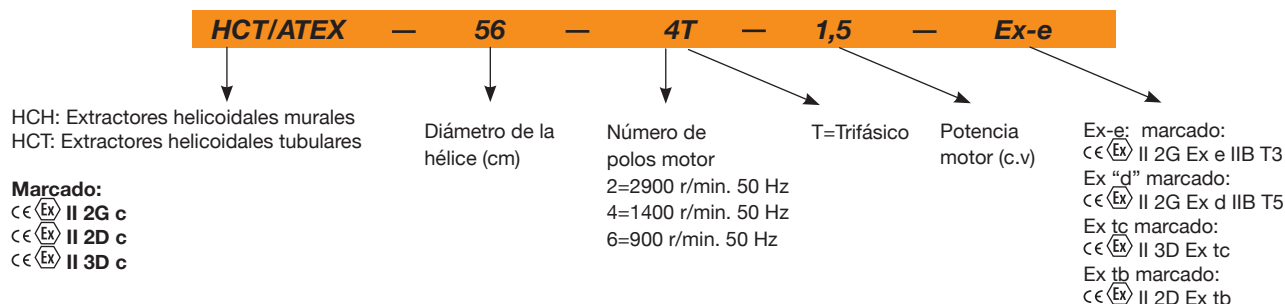

**Características técnicas**

Modelo		Velocidad (r/min)	Intensidad máxima admisible (A)			Potencia instalada (kW)	Caudal máximo (m³/h)	Nivel presión sonora dB(A)	Peso aprox. con motor (Kg)	
			230V	400V	690V				Ex-e	Ex-d
HCH/ATEX	HCT/ATEX	35-2T	2,770	2,08	1,20	0,37	5750	77	13	23
HCH/ATEX	HCT/ATEX	35-4T	1400	1,28	0,74	0,12	3100	59	12	19
HCH/ATEX	HCT/ATEX	40-2T-1,5	2850	4,50	2,60	1,10	8800	84	27	40
HCH/ATEX	HCT/ATEX	40-4T-0,33	1370	2,08	1,20	0,25	5150	64	21	30
	HCT/ATEX	45-2T-2	2800	6,24	3,60	1,50	10650	86	30	49
	HCT/ATEX	45-2T-3	2860	8,66	5,00	2,20	12750	88	33	54
HCH/ATEX	HCT/ATEX	45-4T-0,5	1370	2,60	1,50	0,37	7100	68	25	33
	HCT/ATEX	50-4T-0,75	1410	2,94	1,70	0,55	10400	70	27	41
HCH/ATEX	HCT/ATEX	56-4T-0,75	1410	2,94	1,70	0,55	11050	72	32	46
HCH/ATEX	HCT/ATEX	56-4T-1	1410	3,81	2,20	0,75	12950	73	34	47
HCH/ATEX	HCT/ATEX	56-4T-1,5	1410	5,20	3,00	1,10	14000	74	36	55
HCH/ATEX	HCT/ATEX	56-4T-2	1400	6,93	4,00	1,50	15300	75	39	59
HCH/ATEX	HCT/ATEX	56-6T-0,33	910	2,42	1,40	0,25	8500	61	31	39
HCH/ATEX	HCT/ATEX	56-6T-0,5	935	2,77	1,60	0,37	9300	61	34	43
HCH/ATEX	HCT/ATEX	56-6T-0,75	930	3,46	2,00	0,55	10000	62	34	47
HCH/ATEX	HCT/ATEX	63-4T-1	1410	3,81	2,20	0,75	14150	73	43	56
HCH/ATEX	HCT/ATEX	63-4T-1,5	1410	5,20	3,00	1,10	17000	74	45	64
HCH/ATEX	HCT/ATEX	63-4T-2	1400	6,93	4,00	1,50	18900	75	48	68
HCH/ATEX	HCT/ATEX	63-4T-3	1410	9,01	5,20	2,20	22100	76	53	76
HCH/ATEX	HCT/ATEX	63-4T-4	1440	12,30	7,10	3,00	25400	77	56	79

## Características técnicas

Modelo			Velocidad (r/min)	Intensidad máxima admisible (A)			Potencia instalada (kW)	Caudal máximo (m³/h)	Nivel presión sonora dB(A)	Peso aprox. con motor (Kg)	
				230V	400V	690V				Ex-e	Ex-d
HCH/ATEX	HCT/ATEX	63-6T-0,5	935	2,77	1,60	0,37	12150	64	43	52	
HCH/ATEX	HCT/ATEX	63-6T-0,75	930	3,46	2,00	0,55	12750	65	43	56	
HCH/ATEX	HCT/ATEX	63-6T-1	930	4,16	2,40	0,75	13800	66	45	64	
HCH/ATEX	HCT/ATEX	71-4T-1,5	1410	5,20	3,00	1,10	19750	78	51	70	
HCH/ATEX	HCT/ATEX	71-4T-2	1400	6,93	4,00	1,50	21100	79	54	74	
HCH/ATEX	HCT/ATEX	71-4T-3	1410	9,01	5,20	2,20	23950	81	60	83	
HCH/ATEX	HCT/ATEX	71-4T-4	1440	12,30	7,10	3,00	29400	82	63	86	
HCH/ATEX	HCT/ATEX	71-6T-0,75	930	3,46	2,00	0,55	15150	67	49	62	
HCH/ATEX	HCT/ATEX	71-6T-1	930	4,16	2,40	0,75	17250	68	51	70	
HCH/ATEX	HCT/ATEX	71-6T-1,5	910	5,89	3,40	1,10	20950	69	54	75	
HCH/ATEX	HCT/ATEX	80-4T-3	1410	9,01	5,20	2,20	28000	82	69	92	
HCH/ATEX	HCT/ATEX	80-4T-4	1440	12,30	7,10	3,00	32700	83	72	95	
HCH/ATEX	HCT/ATEX	80-4T-5,5	1450	15,76	9,10	4,00	37200	84	74	98	
HCH/ATEX	HCT/ATEX	80-6T-1	930	4,16	2,40	0,75	20600	71	60	79	
HCH/ATEX	HCT/ATEX	80-6T-1,5	910	5,89	3,40	1,10	24250	72	63	84	
HCH/ATEX	HCT/ATEX	80-6T-2	940	7,62	4,40	1,50	28000	73	71	95	
HCH/ATEX	HCT/ATEX	80-6T-3	940	9,35	5,40	2,20	32500	74	74	98	
HCH/ATEX	HCT/ATEX	90-4T-4	1440	12,30	7,10	3,00	37750	87	87	110	
HCH/ATEX	HCT/ATEX	90-4T-5,5	1450	15,76	9,10	4,00	41850	89	90	114	
HCH/ATEX	HCT/ATEX	90-4T-7,5	1440		12,00	6,93	5,50	47000	91	103	142
HCH/ATEX	HCT/ATEX	90-4T-10	1448		16,30	9,41	7,50	53000	92	111	145
HCH/ATEX	HCT/ATEX	90-6T-2	940	7,62	4,40	1,50	30000	77	86	110	
HCH/ATEX	HCT/ATEX	90-6T-3	940	9,35	5,40	2,20	35000	78	90	114	
HCH/ATEX	HCT/ATEX	90-6T-4	945	14,72	8,50	3,00	40000	79	102	142	
HCH/ATEX	HCT/ATEX	100-4T-7,5	1440		12,00	6,93	5,50	52500	92	115	154
HCH/ATEX	HCT/ATEX	100-4T-10	1448		16,30	9,41	7,50	58500	93	122	156
HCH/ATEX	HCT/ATEX	100-4T-15	1460		23,80	13,74	11,00	68000	94	159	256
HCH/ATEX	HCT/ATEX	100-4T-20	1450		30,60	17,67	15,00	71850	95	178	279
HCH/ATEX	HCT/ATEX	100-6T-3	940	9,35	5,40	2,20	40500	82	101	125	
HCH/ATEX	HCT/ATEX	100-6T-4	945	14,72	8,50	3,00	46950	83	113	153	
HCH/ATEX	HCT/ATEX	100-6T-5,5	950	18,88	10,90	4,00	52000	84	120	156	

## Dimensiones mm

HCH/ATEX

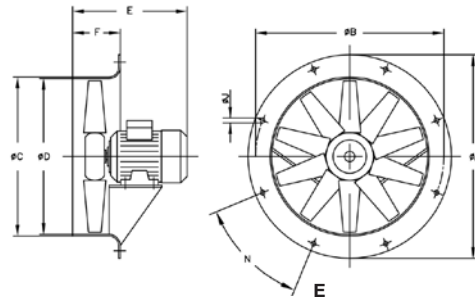

Modelo	ØA	ØB	ØC	ØD	0,16	0,33	0,5	0,75	1	1,5	2	3	4	5,5	7,5	10	15	20	F	ØJ	N
HCH-35-2	425	395	358	355	--	--	285	--	--	--	--	--	--	--	--	--	--	--	110	10	8x45°
HCH-35-4	425	395	358	355	257	--	--	--	--	--	--	--	--	--	--	--	--	--	110	10	8x45°
HCH-40-2	490	450	414	410	--	--	--	--	314	--	--	--	--	--	--	--	--	--	120	12	8x45°
HCH-40-4	490	450	414	410	--	305	--	--	--	--	--	--	--	--	--	--	--	--	120	12	8x45°
HCH-45-4	540	500	464	460	--	--	295	--	--	--	--	--	--	--	--	--	--	--	120	12	8x45°
HCH-45-6	540	500	464	460	--	295	--	--	--	--	--	--	--	--	--	--	--	--	120	12	8x45°
HCH-56-4	660	620	564	560	--	--	--	316	316	330	354	--	--	--	--	--	--	--	120	12	12x30°
HCH-56-6	660	620	564	560	--	298	316	316	--	--	--	--	--	--	--	--	--	--	120	12	12x30°
HCH-63-4	730	690	645	640	--	--	--	--	332	340	366	420	420	--	--	--	--	--	150	12	12x30°
HCH-63-6	730	690	645	640	--	--	332	332	340	--	--	--	--	--	--	--	--	--	150	12	12x30°
HCH-71-4	810	770	715	710	--	--	--	--	--	334	360	430	430	--	--	--	--	--	150	12	16x22°30'
HCH-71-6	810	770	715	710	--	--	--	323	334	360	--	--	--	--	--	--	--	--	150	12	16x22°30'
HCH-80-4	900	860	805	800	--	--	--	--	--	--	425	425	445	--	--	--	--	--	180	12	16x22°30'
HCH-80-6	900	860	805	800	--	--	--	--	360	386	425	445	--	--	--	--	--	--	180	12	16x22°30'
HCH-90-4	1015	970	906	900	--	--	--	--	--	--	--	436	430	465	465	--	--	--	180	12	16x22°30'
HCH-90-6	1015	970	906	900	--	--	--	--	--	--	436	430	465	--	--	--	--	--	180	12	16x22°30'
HCH-100-4	1115	1070	1006	1000	--	--	--	--	--	--	--	--	--	--	480	503	612	612	200	15	16x22°30'
HCH-100-6	1115	1070	1006	1000	--	--	--	--	--	440	503	503	--	--	--	--	--	--	200	15	16x22°30'

Las medidas corresponden a la versión Ex "e"

Dimensiones mm

HCT/ATEX

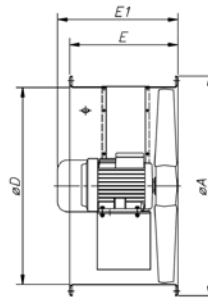
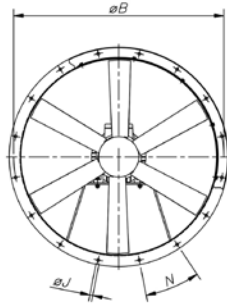

Modelo	ØA	ØB	D	E	E1	ØJ	N
HCT-35-2T/ATEX	425	395	355	280	306	10	8x45°
HCT-35-4T/ATEX	425	395	355	280	322	10	8x45°
HCT-40-2T-1,5/ATEX	490	450	410	400	400	12	8x45°
HCT-40-4T-0,33/ATEX	490	450	410	400	400	12	8x45°
HCT-45-2T-2/ATEX	540	500	460	400	422	12	8x45°
HCT-45-2T-3/ATEX	540	500	460	400	422	12	8x45°
HCT-45-4T-0,5/ATEX	540	500	460	400	400	12	8x45°
HCT-50-4T-0,75/ATEX	600	560	514	400	400	12	12x30°
HCT-56-4T-0,75/ATEX	660	620	560	400	400	12	12x30°
HCT-56-4T-1/ATEX	660	620	560	400	400	12	12x30°
HCT-56-4T-1,5/ATEX	660	620	560	400	422	12	12x30°
HCT-56-4T-2/ATEX	660	620	560	400	422	12	12x30°
HCT-56-6T-0,33/ATEX	660	620	560	400	400	12	12x30°
HCT-56-6T-0,5/ATEX	660	620	560	400	400	12	12x30°
HCT-56-6T-0,75/ATEX	660	620	560	400	400	12	12x30°
HCT-63-4T-1/ATEX	730	690	640	400	400	12	12x30°
HCT-63-4T-1,5/ATEX	730	690	640	400	422	12	12x30°
HCT-63-4T-2/ATEX	730	690	640	400	422	12	12x30°
HCT-63-4T-3/ATEX	730	690	640	500	500	12	12x30°
HCT-63-4T-4/ATEX	730	690	640	500	500	12	12x30°
HCT-63-6T-0,5/ATEX	730	690	640	400	400	12	12x30°
HCT-63-6T-0,75/ATEX	730	690	640	400	400	12	12x30°
HCT-63-6T-1/ATEX	730	690	640	400	422	12	12x30°
HCT-71-4T-1,5/ATEX	810	770	710	430	442	12	16x22°30'
HCT-71-4T-2/ATEX	810	770	710	430	442	12	16x22°30'
HCT-71-4T-3/ATEX	810	770	710	500	500	12	16x22°30'

Modelo	ØA	ØB	D	E	E1	ØJ	N
HCT-71-4T-4/ATEX	810	770	710	500	500	12	16x22°30'
HCT-71-6T-0,75/ATEX	810	770	710	430	430	12	16x22°30'
HCT-71-6T-1/ATEX	810	770	710	500	442	12	16x22°30'
HCT-71-6T-1,5/ATEX	810	770	710	500	442	12	16x22°30'
HCT-80-4T-3/ATEX	900	860	800	500	500	12	16x22°30'
HCT-80-4T-4/ATEX	900	860	800	500	500	12	16x22°30'
HCT-80-4T-5,5/ATEX	900	860	800	500	519	12	16x22°30'
HCT-80-6T-1/ATEX	900	860	800	500	500	12	16x22°30'
HCT-80-6T-1,5/ATEX	900	860	800	500	500	12	16x22°30'
HCT-80-6T-2/ATEX	900	860	800	500	500	12	16x22°30'
HCT-80-6T-3/ATEX	900	860	800	500	519	12	16x22°30'
HCT-90-4T-4/ATEX	1015	970	900	600	600	15	16x22°30'
HCT-90-4T-5,5/ATEX	1015	970	900	600	600	15	16x22°30'
HCT-90-4T-7,5/ATEX	1015	970	900	600	636	15	16x22°30'
HCT-90-4T-10/ATEX	1015	970	900	600	716	15	16x22°30'
HCT-90-6T-2/ATEX	1015	970	900	600	600	15	16x22°30'
HCT-90-6T-3/ATEX	1015	970	900	600	600	15	16x22°30'
HCT-90-6T-4/ATEX	1015	970	900	600	636	15	16x22°30'
HCT-100-4T-7,5/ATEX	1115	1070	1000	600	636	15	16x22°30'
HCT-100-4T-10/ATEX	1115	1070	1000	600	716	15	16x22°30'
HCT-100-4T-15/ATEX	1115	1070	1000	700	738	15	16x22°30'
HCT-100-4T-20/ATEX	1115	1070	1000	700	738	15	16x22°30'
HCT-100-6T-3/ATEX	1115	1070	1000	600	600	15	16x22°30'
HCT-100-6T-4/ATEX	1115	1070	1000	600	636	15	16x22°30'
HCT-100-6T-5,5/ATEX	1115	1070	1000	600	716	15	16x22°30'

Las medidas corresponden a la versión Ex "e"

Características acústicas

Los valores indicados, se determinan mediante medidas de nivel de presión y potencia sonora en dB(A) obtenidas en campo libre a una distancia equivalente a dos veces la envergadura del ventilador más el diámetro de la hélice, con un mínimo de 1,5 mts.

Spectro de potencia sonora Lw(A) en dB(A) banda de frecuencia en [Hz]

Modelo	63	125	250	500	1000	2000	4000	8000
35-2T	48	63	82	81	82	81	76	67
35-4T	30	45	64	63	64	63	58	49
40-2T-1,5	55	70	89	88	89	88	83	74
40-4T-0,33	35	50	69	68	69	68	63	54
45-2T-2	51	68	80	88	93	93	89	82
45-2T-3	53	70	82	90	95	95	91	84
45-4T-0,5	33	50	62	70	75	75	71	64
50-4T-0,75	37	54	67	74	79	80	75	68
56-4T-0,75	47	67	75	80	82	79	72	61
56-4T-1	48	68	76	81	83	80	73	62
56-4T-1,5	49	69	77	82	84	81	74	63
56-4T-2	50	70	78	83	85	82	75	64
56-6T-0,33	36	56	64	69	71	68	61	50
56-6T-0,5	36	56	64	69	71	68	61	50
56-6T-0,75	37	57	65	70	72	69	62	51
63-4T-1	50	70	78	83	85	82	75	64
63-4T-1,5	51	71	79	84	86	83	76	65
63-4T-2	52	72	80	85	87	84	77	66
63-4T-3	53	73	81	86	88	85	78	67
63-4T-4	54	74	82	87	89	86	79	68
63-6T-0,5	41	61	69	74	76	73	66	55
63-6T-0,75	42	62	70	75	77	74	67	56
63-6T-1	43	63	71	76	78	75	68	57
71-4T-1,5	55	75	83	88	90	87	80	69
71-4T-2	56	76	84	89	91	88	81	70
71-4T-3	58	78	86	91	93	90	83	72
71-4T-4	59	79	87	92	94	91	84	73
71-6T-0,75	44	64	72	77	79	76	69	58
71-6T-1	45	65	73	78	80	77	70	59
71-6T-1,5	46	66	74	79	81	78	71	60
80-4T-3	59	79	87	92	94	91	84	73
80-4T-4	60	80	88	93	95	92	85	74
80-4T-5,5	61	81	89	94	96	93	86	75
80-6T-1	48	68	76	81	83	80	73	62
80-6T-1,5	49	69	77	82	84	81	74	63
80-6T-2	50	70	78	83	85	82	75	64
80-6T-3	51	71	79	84	86	83	76	65
90-4T-4	65	86	93	98	101	97	90	79
90-4T-5,5	67	88	95	100	103	99	92	81
90-4T-7,5	69	90	97	102	105	101	94	83
90-4T-10	70	91	98	103	106	102	95	84
90-6T-2	55	76	83	88	91	87	80	69
90-6T-3	56	77	84	89	92	88	81	70
90-6T-4	57	78	85	90	93	89	82	71
100-4T-7,5	72	92	100	105	107	104	97	86
100-4T-10	73	93	101	106	108	105	98	87
100-4T-15	74	94	102	107	109	106	99	88
100-4T-20	75	95	103	108	110	107	100	89
100-6T-3	62	82	90	95	97	94	87	76
100-6T-4	63	83	91	96	98	95	88	77
100-6T-5,5	64	84	92	97	99	96	89	78

Curvas características

Q= Caudal en m<sup>3</sup>/h, m<sup>3</sup>/s y cfm. Pe= Presión estática en mmH<sub>2</sub>O, Pa e inwg.

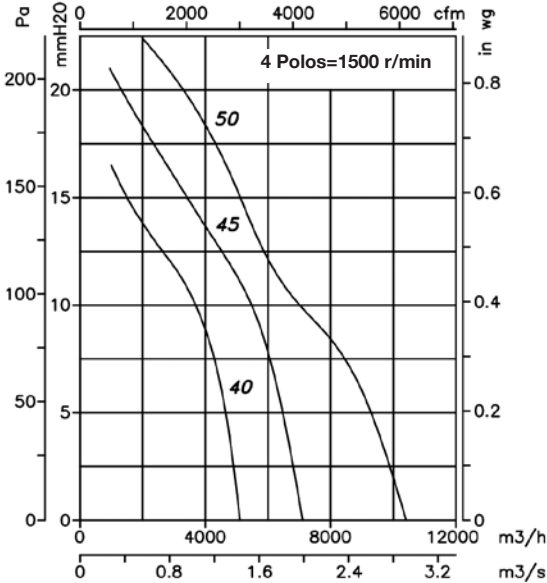
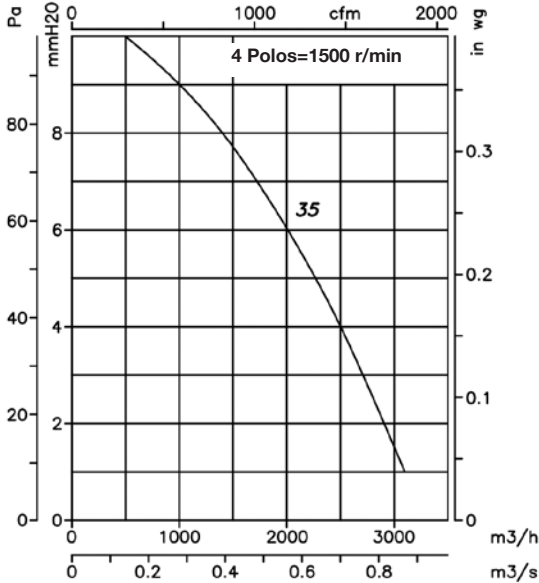
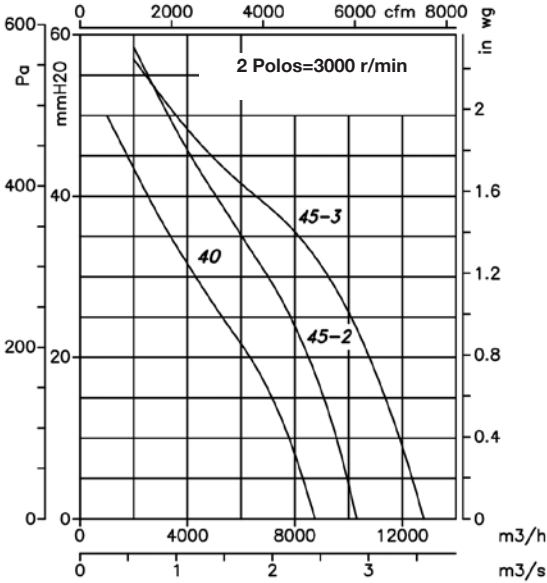
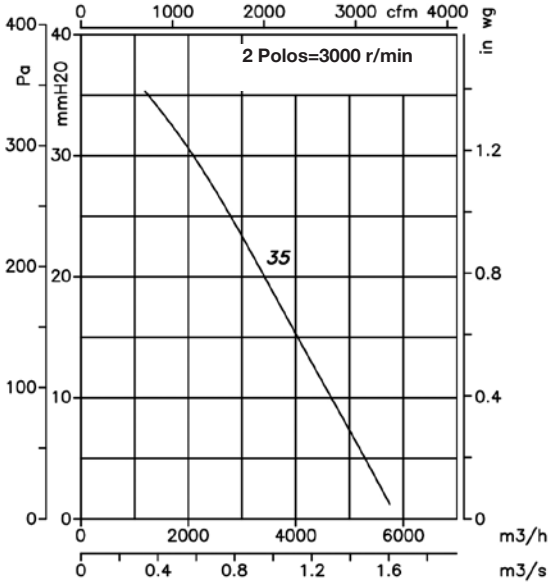

**Curvas características**

Q= Caudal en m<sup>3</sup>/h, m<sup>3</sup>/s y cfm.

Pe= Presión estática en mmH<sub>2</sub>O, Pa e inwg.

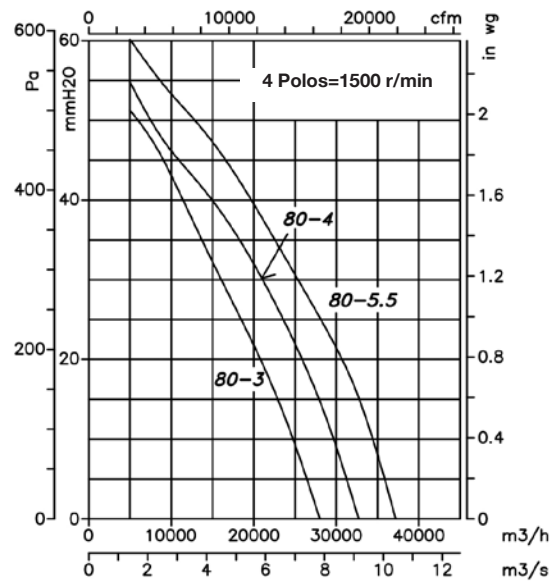
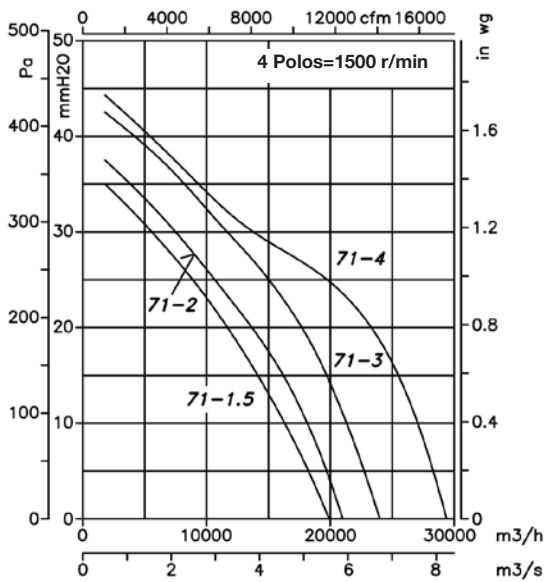
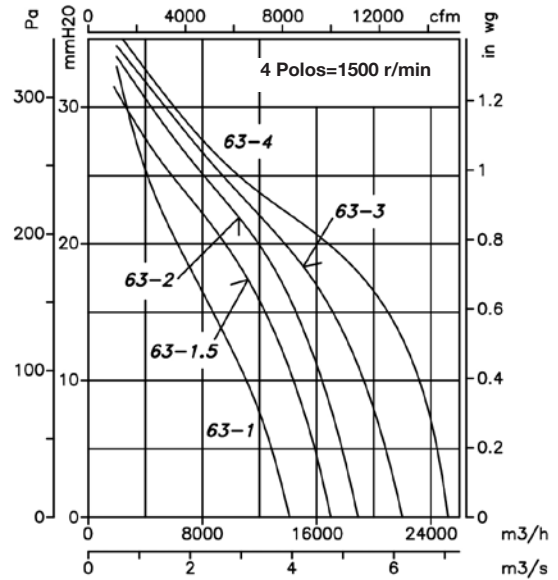
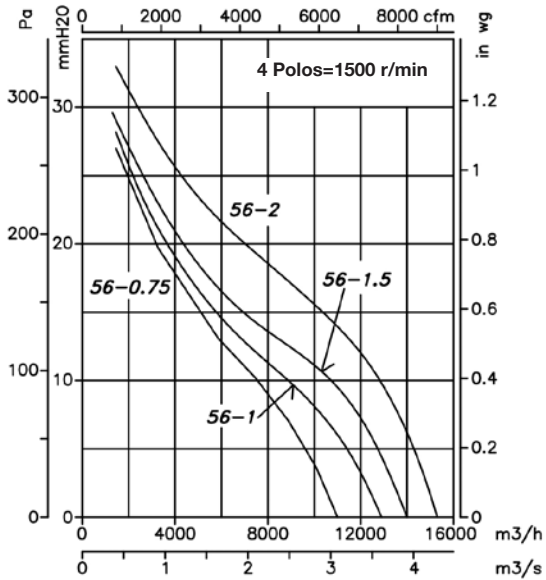



**Curvas características**

Q= Caudal en m<sup>3</sup>/h, m<sup>3</sup>/s y cfm.

Pe= Presión estática en mmH<sub>2</sub>O, Pa e inwg.

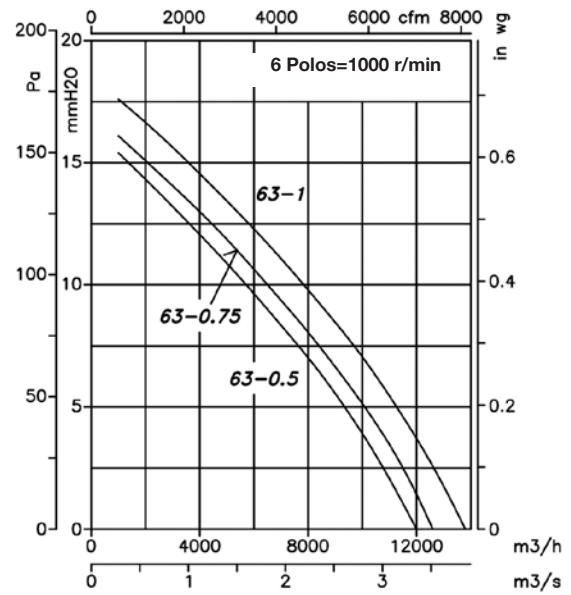
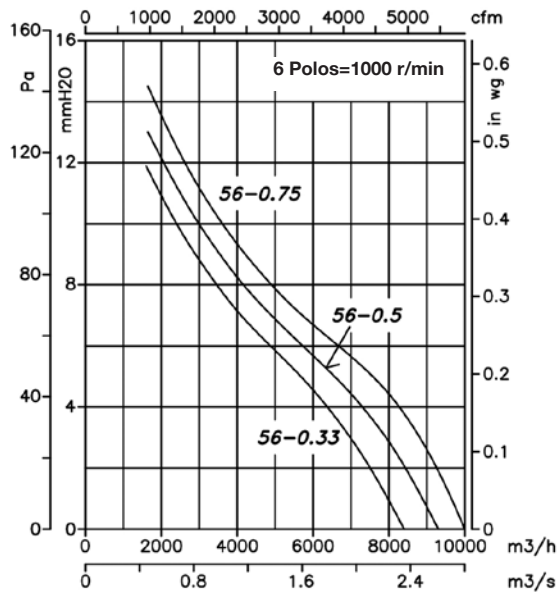
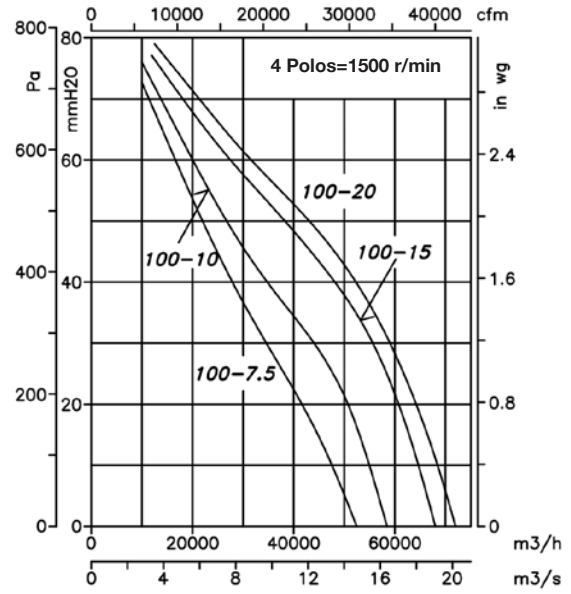
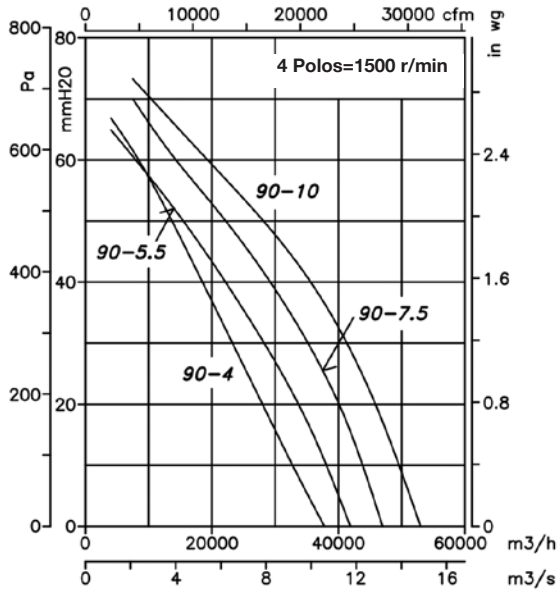

**Curvas características**

Q= Caudal en m<sup>3</sup>/h, m<sup>3</sup>/s y cfm.

Pe= Presión estática en mmH<sub>2</sub>O, Pa e inwg.

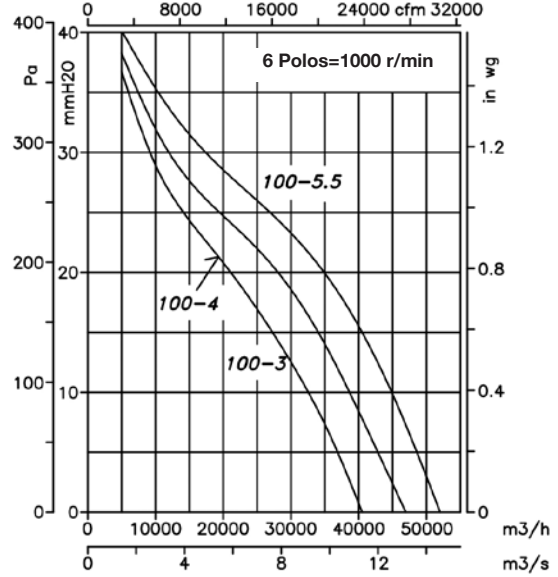
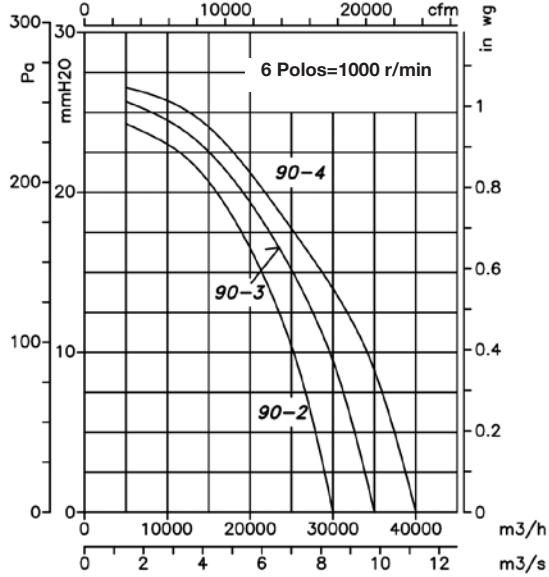
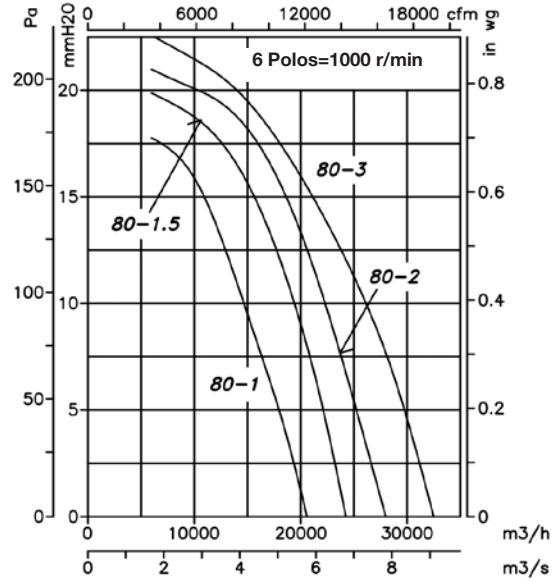
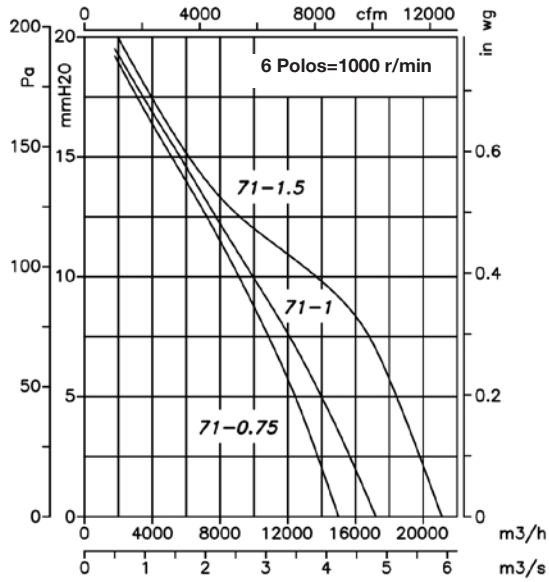

**Accesorios**

Ver apartado accesorios.



# HTM/ATEX

## Extractores tubulares móviles, con Certificación ATEX

Extractores helicoidales tubulares móviles, y Certificación ATEX con motor antiexplosivo CEE ExII2G Ex e, antideflagrante CEE ExII2G Ex d, Ex tc, o Ex tb para trabajar en atmósferas explosivas.



**Ventilador:**

- Envoltente tubular en chapa de acero, con banda de aluminio en la zona de la hélice según norma EN-14986:2007
- Hélice en fundición de aluminio
- Incorpora trampilla de inspección
- Rejilla de protección contra contactos según norma UNE-EN ISO 12499:2010, en ambos lados
- Dirección aire motor-hélice

**Motor:**

- Motores clase F, con rodamientos a bolas con certificación ATEX, antiexplosivos Ex e, antideflagrante Ex d, Ex tc, o Ex tb
- Trifásicos 230/400V.-50Hz.(hasta 4 kW) y 400/690V.-50Hz.(potencias superiores a 4 kW)
- Temperatura de trabajo: -20°C.+ 40°C.



Ex "e" marcado: CEE II 2G Ex e  
 Ex "d" marcado: CEE II 2G Ex d  
 Ex tc marcado: CEE II 3D Ex tc  
 Ex tb marcado: CEE II 2D Ex tb  
**Organismo notificado: L.O.M.**  
**Nº de identificación: LOM3ATEX0157**

**Acabado:**

- Anticorrosivo con pintura ATEX, libre de componentes férricos, en resina de poliéster polimerizada a 190 °C, previo desengrase con tratamiento nanotecnológico libre de fosfatos

**Bajo demanda:**

- Motores con PTC incorporada
- Bobinados especiales para diferentes tensiones y frecuencias
- Construcción ATEX para diferentes categorías
- Extractores con motor de 2 velocidades
- Motores monofásicos antideflagrantes Ex d

### Código de pedido

**HTM/ATEX — 35 — 2T — Ex d**

Ventiladores helicoidales tubulares móviles

Diámetro hélice en cm

Número de polos motor  
 2=2900 r/min. 50 Hz  
 4=1400 r/min. 50 Hz

T=Trifásico

Ex-e: marcado: CEE II 2G Ex e IIB T3  
 Ex "d" marcado: CEE II 2G Ex d IIB T5  
 Ex tc marcado: CEE II 3D Ex tc  
 Ex tb marcado: CEE II 2D Ex tb

**Marcado:**  
 CEE II 2G c  
 CEE II 2D c  
 CEE II 3D c

### Características técnicas

Modelo	Velocidad (r/min)	Intensidad máxima admisible (A)		Potencia instalada (kW)	Caudal máximo (m³/h)	Nivel presión sonora dB(A)	Peso aprox. (Kg)
		230V	400V				
HTM/ATEX-35-2T	2770	2,08	1,20	0,37	5750	77	13
HTM/ATEX-35-4T	1400	1,28	0,74	0,12	3100	59	12
HTM/ATEX-40-4T	1370	2,08	1,20	0,25	5150	64	19
HTM/ATEX-45-4T	1370	2,60	1,50	0,37	7100	68	22
HTM/ATEX-56-4T	1410	2,94	1,70	0,55	11050	72	27
HTM/ATEX-63-4T	1410	5,20	3,00	1,10	17000	74	35

### Características acústicas

Los valores indicados, se determinan mediante medidas de nivel de presión y potencia sonora en dB(A) obtenidas en campo libre a una distancia equivalente a dos veces la envergadura del ventilador más el diámetro de la hélice, con un mínimo de 1,5 mts.

Espectro de potencia sonora Lw(A) en dB(A) por banda de frecuencia en Hz

Modelo	63	125	250	500	1000	2000	4000	8000	Modelo	63	125	250	500	1000	2000	4000	8000
35-2	42	59	71	79	84	84	80	73	45-4	33	50	62	70	75	75	71	64
35-4	24	41	53	61	66	66	62	55	56-4	39	56	69	76	81	82	77	70
40-4	29	46	58	66	71	71	67	60	63-4	43	60	73	80	85	86	81	74

**Dimensiones mm**

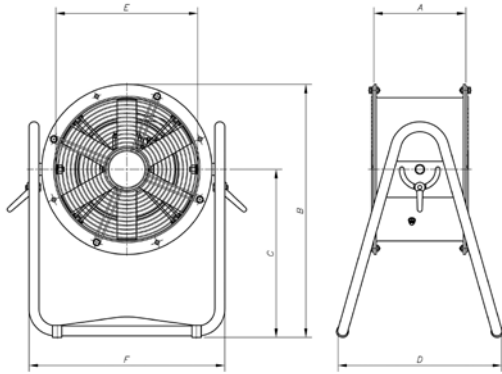

Modelo	A	B	C	D	E	F
HTM-35/ATEX	230	635	420	415	355	489
HTM-40/ATEX	320	725	481	450	410	596
HTM-45/ATEX	360	750	481	453	460	596
HTM-56/ATEX	400	925	594	522	560	726
HTM-63/ATEX	430	960	594	522	640	805

**Características del dardo con el ventilador situado a 1 metro del punto 0**

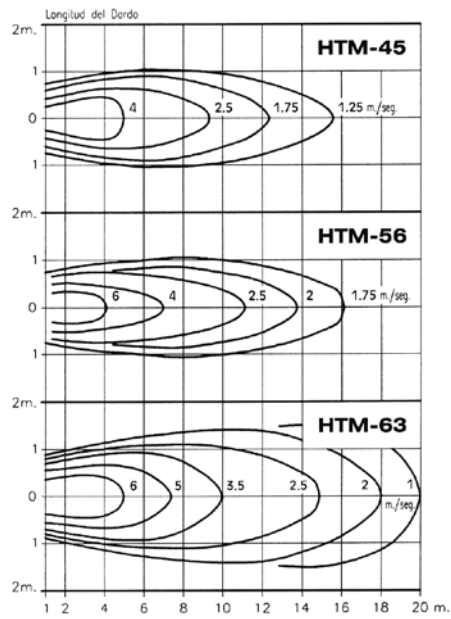
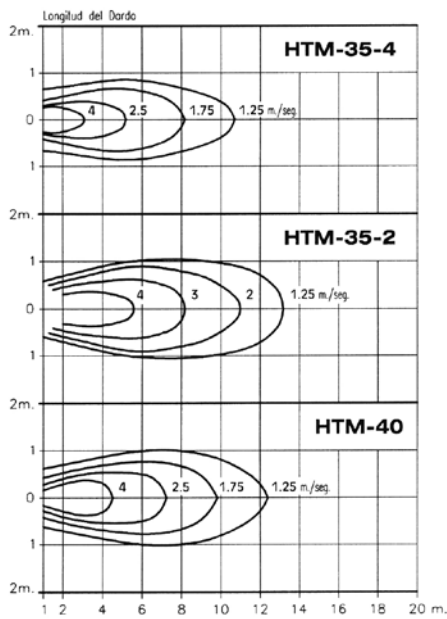

**Accesorios**

Ver apartado accesorios.



# HPX/ATEX *Extractores helicoidales tubulares, con motor exterior y Certificación ATEX*

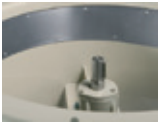

Banda de aluminio para prevenir chispas según norma EN-14986:2007

Extractores helicoidales tubulares, accionados a transmisión, con apertura de envoltorio hasta 180° para trabajar en atmósferas explosivas.

**Ventilador:**

- Envoltorio tubular en chapa de acero, con banda de aluminio en la zona de la hélice según norma EN-14986:2007
- Hélices en fundición de aluminio
- Protector correas y poleas con recubrimiento de cobre para evitar chispas
- Grupo de transmisión estanco (IP66) con sistema de doble retén
- Dirección aire motor-hélice
- Temperatura del aire a transportar -20°C.+ 120°C.

**Motor:**

- Motores clase F, con rodamientos a bolas, protección IP55, con certificación ATEX, antiexplosivos Ex"e", antideflagrantes Ex"d", Ex tc, o Ex tb
- Trifásicos 230/400V.-50Hz.(hasta 4 kW) y 400/690V.-50Hz.(potencias superiores a 4 kW)



Ex "e" marcado: CEE (Ex) II 2G Ex e  
 Ex "d" marcado: CEE (Ex) II 2G Ex d  
 Ex "n" marcado: CEE (Ex) II 3G  
 Ex tc marcado: CEE (Ex) II 3D Ex tc  
 Ex tb marcado: CEE (Ex) II 2D Ex tb  
 Organismo notificado: L.O.M.  
 Nº de identificación:  
**LOM3ATEX0132**

**Acabado:**

- Anticorrosivo con pintura ATEX, libre de componentes férricos, en resina de poliéster polimerizada a 190 °C, previo desengrase con tratamiento nanotecnológico libre de fosfatos

**Bajo demanda:**

- Motores con PTC incorporada
- Bobinados especiales para diferentes tensiones y frecuencias
- Construcción ATEX para diferentes categorías
- Extractores con motor de 2 velocidades
- Versión Ex "nA" equipados con motores ATEX Ex nA

## Código de pedido

**HPX/ATEX — 63 — 4T — 2 — Ex-e**

Extractores helicoidales tubulares, con motor exterior y Certificación ATEX

**Marcado:**

- CEE (Ex) II 2G c
- CEE (Ex) II 3G c
- CEE (Ex) II 2D c
- CEE (Ex) II 3D c

Diámetro de la hélice (cm)

Número de polos motor  
 2=2900 r/min. 50 Hz  
 4=1400 r/min. 50 Hz

T=Trifásico  
 M=Monofásico

Potencia motor (c.v)

Ex-e marcado: CEE (Ex) II 2G Ex e IIB T3  
 Ex "d" marcado: CEE (Ex) II 2G Ex d IIB T5  
 Ex tc marcado: CEE (Ex) II 3D Ex tc  
 Ex tb marcado: CEE (Ex) II 2D Ex tb

## Características técnicas

Modelo	Velocidad (r/min)	Intensidad máxima admisible (A)			Potencia instalada (kW)	Caudal máximo (m³/h)	Nivel presión sonora dB(A)	Peso aprox. (Kg)
		230V	400V	690V				
HPX/ATEX-35-2T-0,75	2710	2,94	1,70		0,55	4750	77	22
HPX/ATEX-35-4T-0,33	1370	2,08	1,20		0,25	2500	60	20
HPX/ATEX-45-4T-0,33	1370	2,08	1,20		0,25	6300	69	32
HPX/ATEX-45-4T-0,50	1370	2,60	1,50		0,37	6600	70	36
HPX/ATEX-50-4T-0,75	1410	2,94	1,70		0,55	9000	70	33
HPX/ATEX-50-4T-1	1410	3,81	2,20		0,75	10800	71	34
HPX/ATEX-56-4T-0,75	1410	2,94	1,70		0,55	11300	72	36
HPX/ATEX-56-4T-1	1410	3,81	2,20		0,75	12200	73	36
HPX/ATEX-56-4T-1,5	1410	5,20	3,00		1,10	14500	75	39
HPX/ATEX-63-4T-1,5	1410	5,20	3,00		1,10	16000	74	59
HPX/ATEX-63-4T-2	1400	6,93	4,00		1,50	17500	78	63
HPX/ATEX-71-4T-1,5	1410	5,20	3,00		1,10	20300	78	74
HPX/ATEX-71-4T-2	1400	6,93	4,00		1,50	22500	79	77
HPX/ATEX-71-4T-3	1410	9,01	5,20		2,20	24000	81	85
HPX/ATEX-80-4T-3	1410	9,01	5,20		2,20	29000	83	95
HPX/ATEX-80-4T-4	1440	12,30	7,10		3,00	32000	84	100
HPX/ATEX-80-4T-5,5	1450	15,76	9,10		4,00	40500	84	106
HPX/ATEX-90-4T-5,5	1450	15,76	9,10		4,00	44000	89	118
HPX/ATEX-90-4T-7,5	1440		12,00	6,93	5,50	51000	91	132
HPX/ATEX-100-4T-10	1448		16,30	9,41	7,50	63000	93	159
HPX/ATEX-100-4T-15	1460		23,80	13,74	11,00	68000	94	181

**Características acústicas**

Los valores indicados, se determinan mediante medidas de nivel de presión y potencia sonora en dB(A) obtenidas en campo libre a una distancia equivalente a dos veces la envergadura del ventilador más el diámetro de la hélice, con un mínimo de 1,5 mts.

Espectro de potencia sonora Lw(A) en dB(A) banda de frecuencia en [Hz]

Modelo	63	125	250	500	1000	2000	4000	8000	Modelo	63	125	250	500	1000	2000	4000	8000
35-2-0,75	48	63	82	81	82	81	76	67	71-4-1,5	55	75	83	88	90	87	80	69
35-4-0,33	31	46	65	64	65	64	59	50	71-4-2	56	76	84	89	91	88	81	70
45-4-0,33	40	55	74	73	74	73	68	59	71-4-3	65	76	86	92	93	88	77	73
45-4-0,50	41	56	75	74	75	74	69	60	80-4-3	60	80	88	93	95	92	85	74
50-4-0,75	44	58	77	77	78	76	72	63	80-4-4	61	81	89	94	96	93	86	75
50-4-1	45	59	78	78	79	77	73	64	80-4-5,5	68	79	89	95	96	91	80	76
56-4-0,75	47	67	75	80	82	79	72	61	90-4-5,5	67	88	95	100	103	99	92	81
56-4-1	48	68	76	81	83	80	73	62	90-4-7,5	69	90	97	102	105	101	94	83
56-4-1,5	57	68	78	84	85	80	69	65	100-4-10	73	93	100	106	108	105	98	87
63-4-1,5	51	71	79	84	86	83	76	65	100-4-15	74	94	101	107	109	106	99	88
63-4-2	62	73	83	89	90	85	74	70									

**Dimensiones mm**

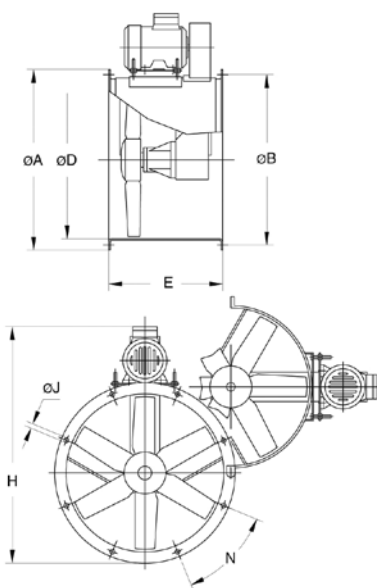

Modelo	ØA	ØB	ØD	E	H	ØJ	N
HPX-35-2T-0,75	425	395	355	380	606	10	8x45°
HPX-35-4T-0,16	425	395	355	380	609	10	8x45°
HPX-45-4T-0,33	540	500	460	420	740	12	8x45°
HPX-45-4T-0,50	540	500	460	420	728	12	8x45°
HPX-50-4T-0,75	600	560	512	420	803	12	12x30°
HPX-50-4T-1	600	560	512	420	803	12	12x30°
HPX-56-4T-0,75	660	620	560	450	848	12	12x30°
HPX-56-4T-1	660	620	560	450	848	12	12x30°
HPX-56-4T-1,5	600	620	560	450	870	12	12x30°
HPX-63-4T-1,5	730	690	640	500	950	12	12x30°
HPX-63-4T-2	730	690	640	500	950	12	12x30°
HPX-71-4T-1,5	810	770	710	550	1017	12	16x22°30'
HPX-71-4T-2	810	770	710	550	1017	12	16x22°30'
HPX-71-4T-3	810	770	710	550	1035	12	16x22°30'
HPX-80-4T-3	900	860	800	600	1173	12	16x22°30'
HPX-80-4T-4	900	860	800	600	1173	12	16x22°30'
HPX-80-4T-5,5	900	860	800	600	1200	12	16x22°30'
HPX-90-4T-5,5	1015	970	900	650	1320	15	16x22°30'
HPX-90-4T-7,5	1015	970	900	650	1320	15	16x22°30'
HPX-100-4T-10	1115	1070	1000	750	1483	15	16x22°30'
HPX-100-4T-15	1115	1070	1000	750	1513	15	16x22°30'

**Curvas características**

Q= Caudal en m³/h, m³/s y cfm.

Pe= Presión estática en mmH2O, Pa e inwg.

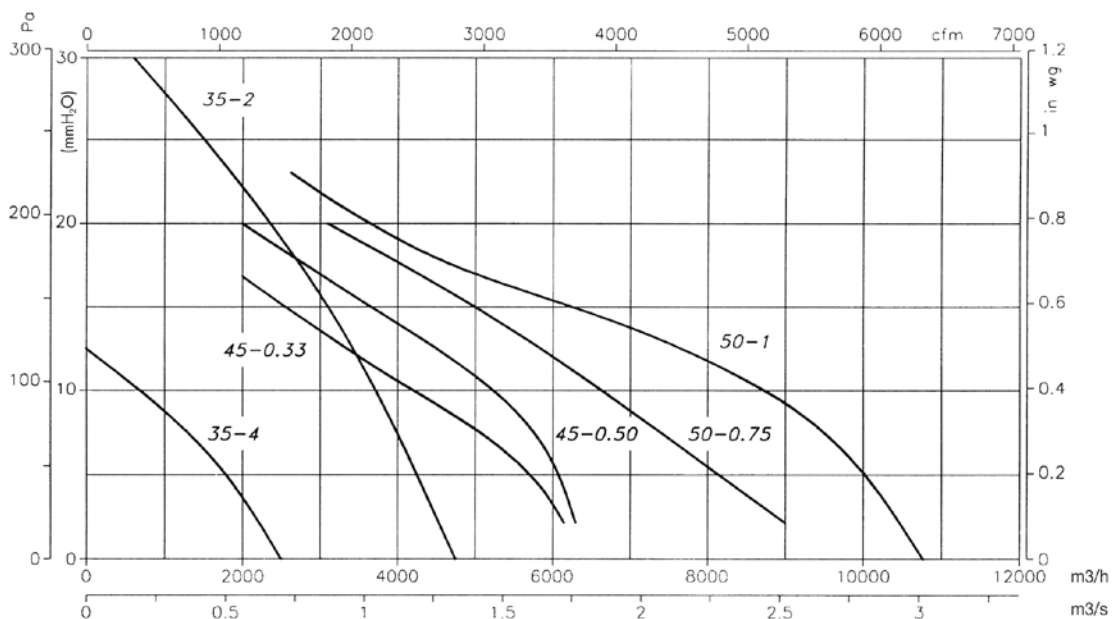

**Curvas características**

Q= Caudal en m<sup>3</sup>/h, m<sup>3</sup>/s y cfm.

Pe= Presión estática en mmH<sub>2</sub>O, Pa e inwg.

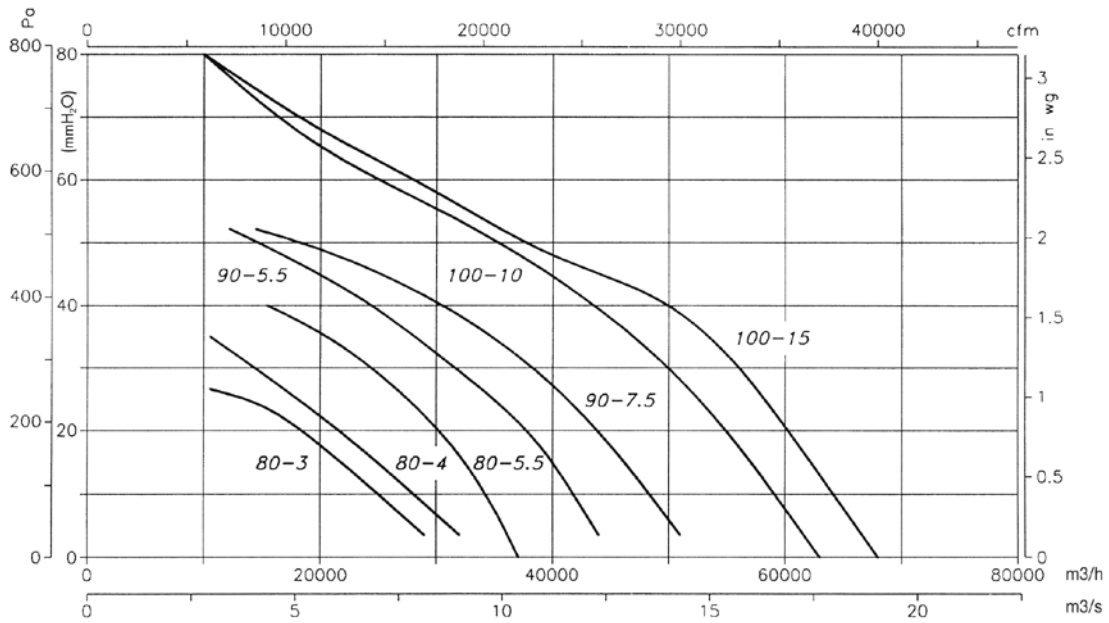
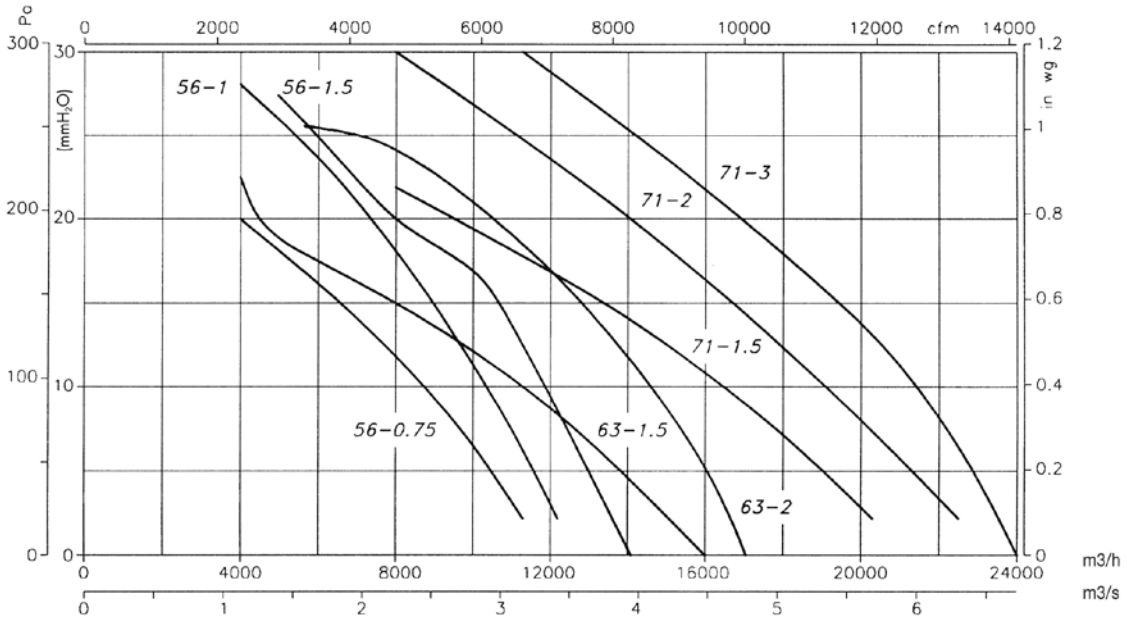

**Accesorios**

Ver apartado accesorios.

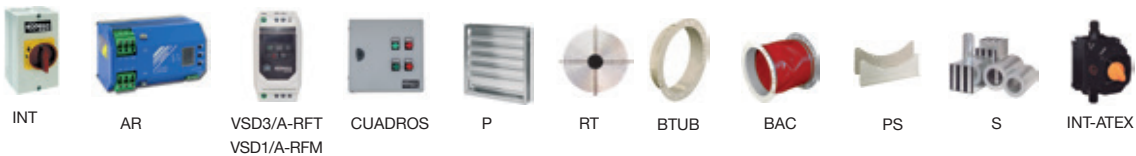

# CPV/ATEX *Extractores centrífugos anticorrosivos en material plástico, con certificación ATEX*



Extractores centrífugos de simple aspiración fabricados en material plástico antiestático ATEX, para trabajar en atmósferas explosivas, con motor antiexplosivo CEE ExII3G Ex e o antideflagrante CEE ExII3G Ex d

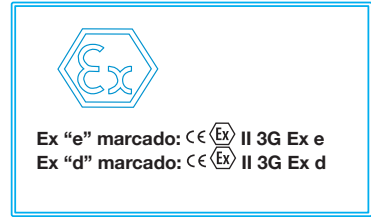

**Ventilador:**

- Envoltorio en material plástico antiestático ATEX
- Turbina con álabes hacia adelante, en material plástico antiestático ATEX

**Motor:**

- Motores clase F, con rodamientos a bolas, protección IP55, con certificación ATEX, antiexplosivos Ex"e" o antideflagrantes Ex"d"
- Trifásicos 230/400V.-50Hz.(hasta 4 kW) y 400/690V.-50Hz.(potencias superiores a 4 kW)
- Temperatura máxima del aire a transportar: -20°C.+ 80°C.

**Acabado:**

- Anticorrosivo en material plástico ATEX

**Bajo demanda:**

- Motores con PTC incorporada
- Bobinados especiales para diferentes tensiones y frecuencias
- Construcción ATEX para diferentes categorías

**Código de pedido**

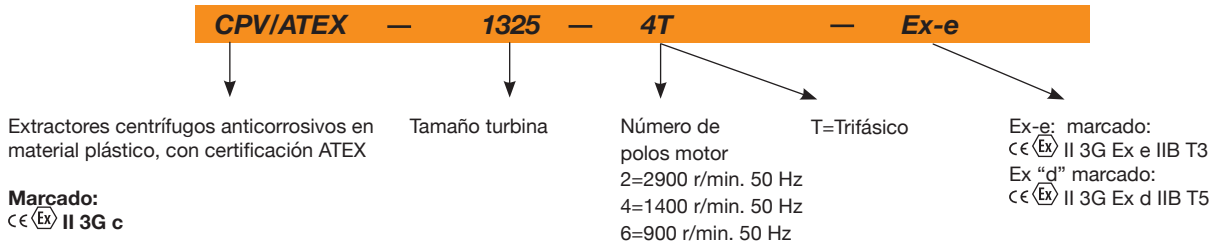

**Características técnicas**

Modelo	Velocidad (r/min)	Intensidad máxima admisible (A)		Potencia instalada (kW)	Caudal máximo (m³/h)	Nivel presión sonora dB(A)	Peso aprox. (Kg)
		230V	400V				
CPV/ATEX-815-2T	2770	2,08	1,20	0,37	950	75	14,0
CPV/ATEX-815-4T	1370	2,08	1,20	0,25	450	58	14,0
CPV/ATEX-1020-2T	2820	3,46	2,00	0,75	2000	81	19,5
CPV/ATEX-1020-4T	1370	2,08	1,20	0,25	1250	65	19,5
CPV/ATEX-1020-6T	910	2,42	1,40	0,25	750	53	19,5
CPV/ATEX-1325-2T	2860	8,66	5,00	2,20	3250	87	27,0
CPV/ATEX-1325-4T	1370	2,60	1,50	0,37	2300	69	27,0
CPV/ATEX-1325-6T	910	2,42	1,40	0,25	1400	59	27,0
CPV/ATEX-1630-4T	1400	6,93	4,00	1,50	4500	75	34,5
CPV/ATEX-1630-6T	930	3,46	2,00	0,55	2700	63	34,5

**Características acústicas**

Los valores indicados, se determinan mediante medidas de nivel de presión y potencia sonora en dB(A) obtenidas en campo libre a una distancia equivalente a dos veces la envergadura del ventilador más el diámetro de la turbina, con un mínimo de 1,5 mts.

Espectro de potencia sonora Lw(A) en dB(A) por banda de frecuencia en Hz

Modelo	63	125	250	500	1000	2000	4000	8000	Modelo	63	125	250	500	1000	2000	4000	8000
815-2	56	69	77	81	81	77	73	65	1325-2	70	83	91	95	96	92	88	79
815-4	39	52	60	64	64	60	56	48	1325-4	52	65	73	77	78	74	70	61
1020-2	62	75	83	87	87	83	79	71	1325-6	42	55	63	67	68	64	60	51
1020-4	46	59	67	71	71	67	63	55	1630-4	60	73	81	85	86	82	78	69
1020-6	34	47	55	59	59	55	51	43	1630-6	48	61	69	73	74	70	66	57



Dimensiones mm

CPV-815...1630

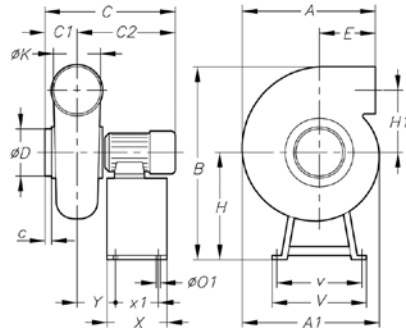

Modelo	A	A1	B	C	C1	C2	c	øD	E	H	H1	øK	øO1	V	v	X	x1	Y
CPV/ATEX-815	307	335	521	360	100	260	30	125	100	281	177,5	125	8	355	335	180	160	90
CPV/ATEX-1020-2T	340	397	593	445,5	116	329,5	32	160	100	290	223	160	8	355	335	180	160	127,5
CPV/ATEX-1020-4/6T	340	397	584	422,5	116	306,5	32	160	100	281	223	160	8	355	335	180	160	122,5
CPV/ATEX-1325-2T	413	505	735	494	130	364	35	200	103	370	265	200	8	400	380	180	160	125
CPV/ATEX-1325-4/6T	413	505	716	432,5	130	302,5	35	200	103	351	265	200	8	400	380	180	160	113,5
CPV/ATEX-1630-4T	480	602	890	536,5	145	391,5	35	250	117	440	323	250	8	450	430	240	220	142,5
CPV/ATEX-1630-6T	480	602	880	503	145	358	35	250	117	430	323	250	8	450	430	240	220	138

Curvas características

Q= Caudal en m³/h, m³/s y cfm.

Pe= Presión estática en mmH2O, Pa e inwg.

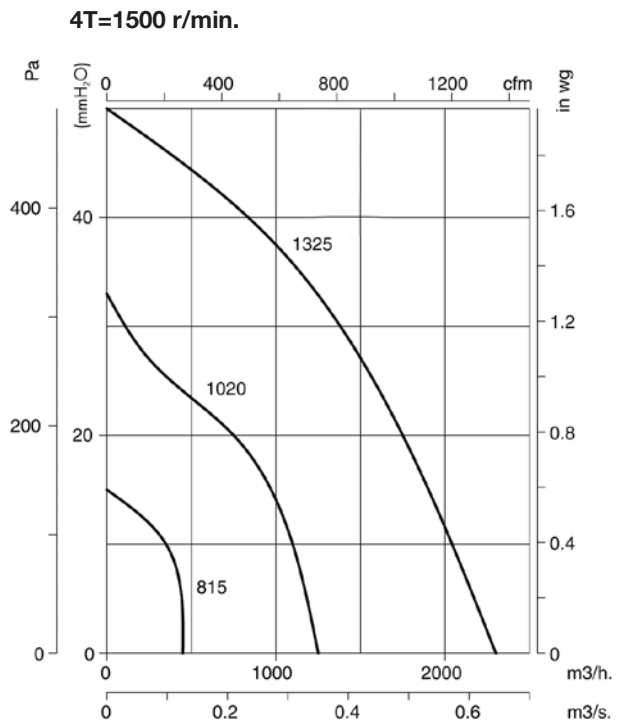
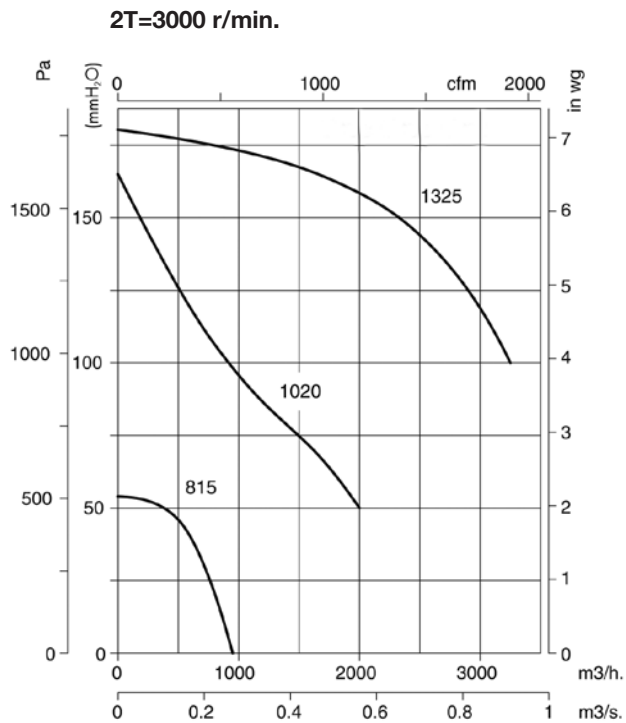

**Curvas características**

Q= Caudal en m<sup>3</sup>/h, m<sup>3</sup>/s y cfm.

Pe= Presión estática en mmH<sub>2</sub>O, Pa e inwg.

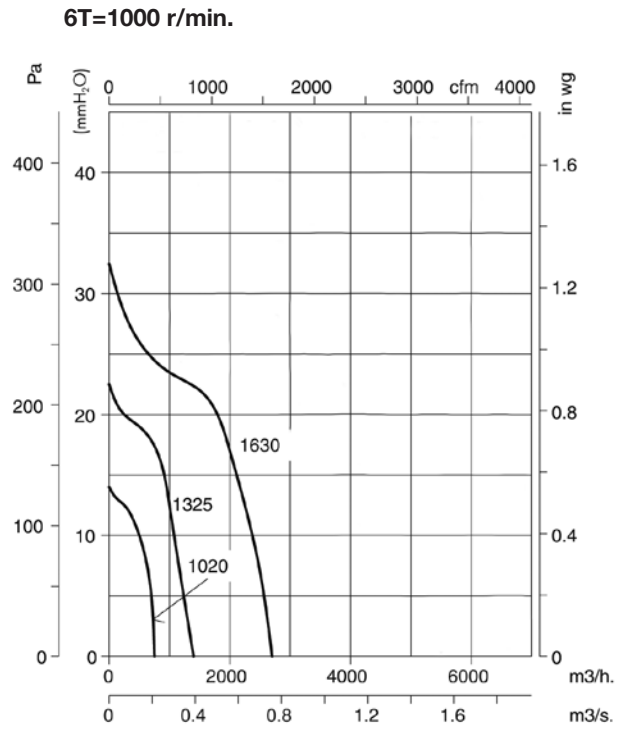
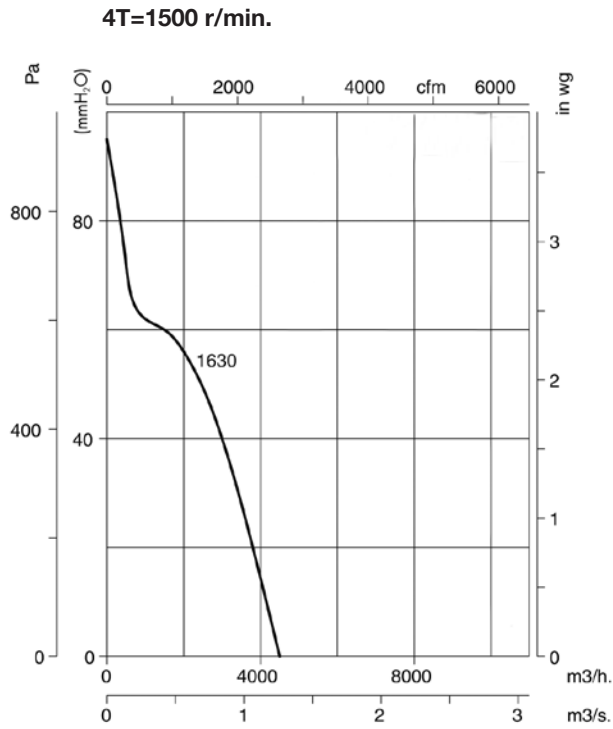

**Orientaciones**

Suministro standard LG 90



**Accesorios**

Ver apartado accesorios.



# CMA/ATEX *Extractores centrífugos de media presión en fundición de aluminio, con certificación ATEX*

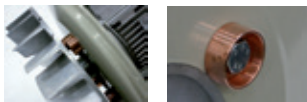

Extractores centrífugos de media presión y simple aspiración con envolvente y turbina en fundición de aluminio, para trabajar en atmósferas explosivas.

**Ventilador:**

- Envolvente en fundición de aluminio
- Turbina en fundición de aluminio

**Motor:**

- Motores clase F, con rodamientos a bolas, protección IP55, con certificación ATEX, antiexplosivos Ex"e" o antideflagrantes Ex"d"
- Trifásicos 230/400V.-50Hz.(hasta 4 kW) y 400/690V.-50Hz.(potencias superiores a 4 kW)
- Temperatura máxima del aire a transportar: -20°C.+ 80°C.



Ex "e" marcado: C<sup>o</sup> E<sup>o</sup> II 2G Ex e  
 Ex "d" marcado: C<sup>o</sup> E<sup>o</sup> II 2G Ex d  
 Ex tc marcado: C<sup>o</sup> E<sup>o</sup> II 3D Ex tc  
 Ex tb marcado: C<sup>o</sup> E<sup>o</sup> II 2D Ex tb  
**Organismo notificado: L.O.M.**  
**Nº de identificación: LOM04ATEX0007**

**Acabado:**

- Anticorrosivo con pintura ATEX, libre de componentes férricos, en resina de poliéster polimerizada a 190 °C, previo desengrase con tratamiento nanotecnológico libre de fosfatos

**Bajo demanda:**

- Motores con PTC incorporada
- Bobinados especiales para diferentes tensiones y frecuencias
- Construcción ATEX para diferentes categorías

## Código de pedido

**CMA/ATEX — 531 — 4T — 2 — Ex-e**

Extractores centrífugos de media presión en fundición de aluminio, con certificación ATEX

Tamaño turbina

Número de polos motor  
 2=2900 r/min. 50 Hz

T=Trifásico

Potencia motor (c.v)

Ex-e: marcado: C<sup>o</sup> E<sup>o</sup> II 2G Ex e IIB T3  
 Ex "d" marcado: C<sup>o</sup> E<sup>o</sup> II 2G Ex d IIB T5  
 Ex tc marcado: C<sup>o</sup> E<sup>o</sup> II 3D Ex tc  
 Ex tb marcado: C<sup>o</sup> E<sup>o</sup> II 2D Ex tb

**Marcado:**

C<sup>o</sup> E<sup>o</sup> II 2G c  
 C<sup>o</sup> E<sup>o</sup> II 2D c  
 C<sup>o</sup> E<sup>o</sup> II 3D c

## Características técnicas

Modelo	Velocidad (r/min)	Intensidad máxima (A)		Potencia instalada (kW)	Caudal máximo (m³/h)	Nivel presión sonora dB(A)	Peso aprox. con motor (Kg)	
		230V	400V				Ex-e	Ex-d
CMA-324-2T/ATEX	2760	1,21	0,70	0,18	440	70	10	16
CMA-325-2T/ATEX	2740	1,73	1,00	0,25	600	73	12	19
CMA-426-2T/ATEX	2770	2,08	1,20	0,37	850	75	14	24
CMA-527-2T/ATEX	2710	2,94	1,70	0,55	1000	80	17	25
CMA-528-2T-1/ATEX	2820	3,46	2,00	0,75	1250	82	24	36
CMA-528-2T-1,5/ATEX	2850	4,50	2,60	1,10	1750	83	27	40
CMA-531-2T-1,5/ATEX	2850	4,50	2,60	1,10	1790	84	30	43
CMA-531-2T-2/ATEX	2800	6,24	3,60	1,50	2000	85	31	50
CMA-540-2T/ATEX	2800	6,24	3,60	1,50	2600	85	38	57
CMA-545-2T-3/ATEX	2860	8,66	5,00	2,20	2630	86	54	75
CMA-545-2T-4/ATEX	2845	12,12	7,00	3,00	3550	88	63	87

### Características acústicas

Los valores indicados, se determinan mediante medidas de nivel de presión y potencia sonora en dB(A) obtenidas en campo libre a una distancia equivalente a dos veces la envergadura del ventilador más el diámetro de la turbina, con un mínimo de 1,5 mts.

Espectro de potencia sonora Lw(A) en dB(A) banda de frecuencia en [Hz]

Modelo	Lp dB (A)	63	125	250	500	1000	2000	4000	8000
CMA-324-2T/ATEX	70	36	50	68	74	78	75	70	61
CMA-325-2T/ATEX	73	39	53	71	77	81	78	73	64
CMA-426-2T/ATEX	75	41	55	73	79	83	80	75	66
CMA-527-2T/ATEX	80	46	60	78	84	88	85	80	71
CMA-528-2T-1/ATEX	82	48	62	80	86	90	87	82	73
CMA-528-2T-1.5/ATEX	83	49	63	81	87	91	88	83	74

Modelo	Lp dB (A)	63	125	250	500	1000	2000	4000	8000
CMA-531-2T-1.5/ATEX	84	50	64	82	88	92	89	84	75
CMA-531-2T-2/ATEX	85	51	65	83	89	93	90	85	76
CMA-540-2T/ATEX	85	54	67	85	91	96	92	87	79
CMA-545-2T-3/ATEX	86	55	68	86	92	97	93	88	80
CMA-545-2T-4/ATEX	88	57	70	88	94	99	95	90	82

### Dimensiones mm

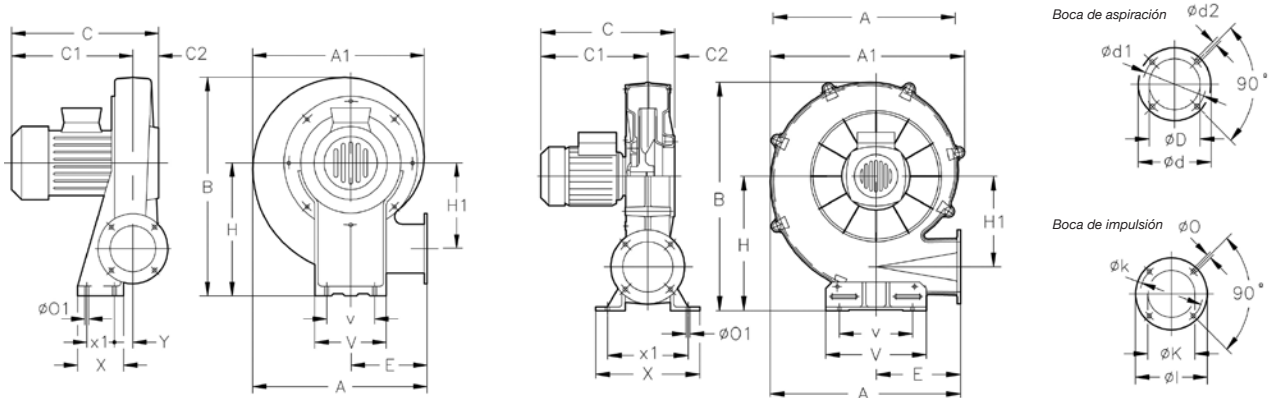

Modelo	Ex-"e"		Ex-"d"																						
	A	A1	B	C	C1	C	C1	C2	øD	ød	ød1	ød2	E	H	H1	øI	øK	øk	øO	øO1	V	v	X	x1	Y
CMA-324-2T/ATEX	311	302	356	263	225	288	250	38	80	130	112	M5	145	205	145	108	62	90	7	9	173	125	90	60	20
CMA-325-2T/ATEX	335	328	399	266	226	291	251	40	94	140	122	M6	155	235	152	120	80	102	7	9	180	145	110	80	20
CMA-426-2T/ATEX	354	344	412	293	253	316	276	40	117	155	132	M6	162	240	163	140	90	119	7	13	210	160	105	65	26
CMA-527-2T/ATEX	371	361	440	297	255	320	280	42	125	170	147	M6	168	260	170	155	100	129	7	13	220	170	120	80	20
CMA-528-2T-1/ATEX	401	395	488	340	292	342	294	51	116	190	162	M6	178	290	177	190	130	160	11	13	230	180	140	100	20
CMA-528-2T-1.5/ATEX	401	395	488	339	291	337	289	48	135	190	162	M6	178	290	177	190	130	160	11	13	230	180	140	100	20
CMA-531-2T-1.5/ATEX	440	434	537	340	292	342	294	50	160	215	180	M6	193	320	200	200	140	175	11	13	240	190	160	120	21
CMA-531-2T-2/ATEX	440	434	537	338	288	392	342	50	160	215	180	M6	193	320	200	200	140	175	11	13	240	190	160	120	21

Modelo	Ex-"e"		Ex-"d"																						
	A	A1	B	C	C1	C	C1	C2	øD	ød	ød1	ød2	E	H	H1	øI	øK	øk	øO	øO1	V	v	X	x1	Y
CMA-540-2T/ATEX	567	580	695	365	285	419	339	80	170	240	205	M10	252	415	270	220	150	190	13	11	336	218	374	240	-
CMA-545-2T-3/ATEX	651	646	776	438	323	467	352	115	180	255	220	M10	290	450	309	250	175	220	13	13	336	238	392	292	-
CMA-545-2T-4/ATEX	651	646	776	461	346	511	396	115	180	255	220	M10	290	450	309	250	175	220	13	13	336	238	392	292	-

**Curvas características**

Q= Caudal en m<sup>3</sup>/h, m<sup>3</sup>/s y cfm.

Pe= Presión estática en mmH<sub>2</sub>O, Pa e inwg.

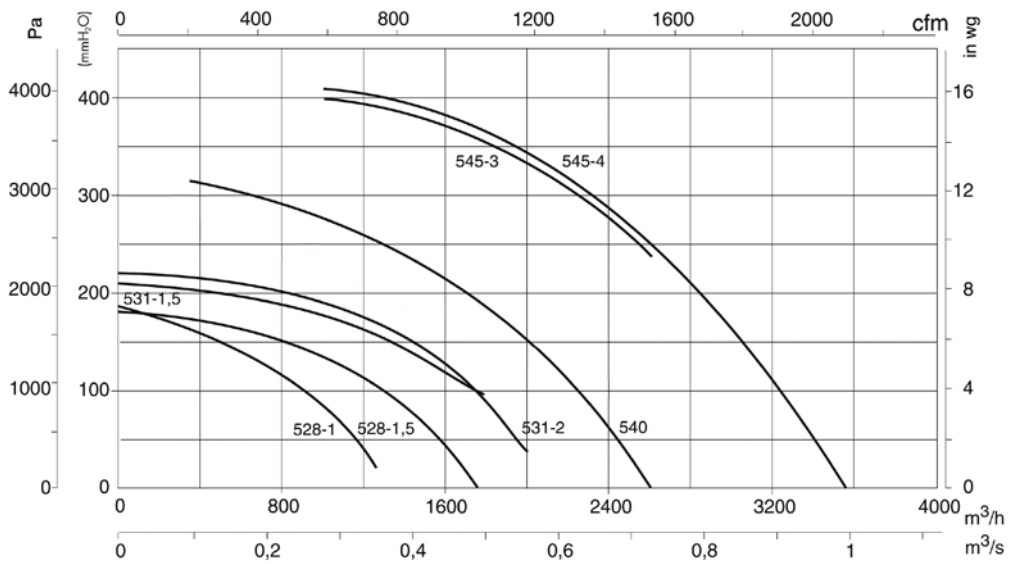
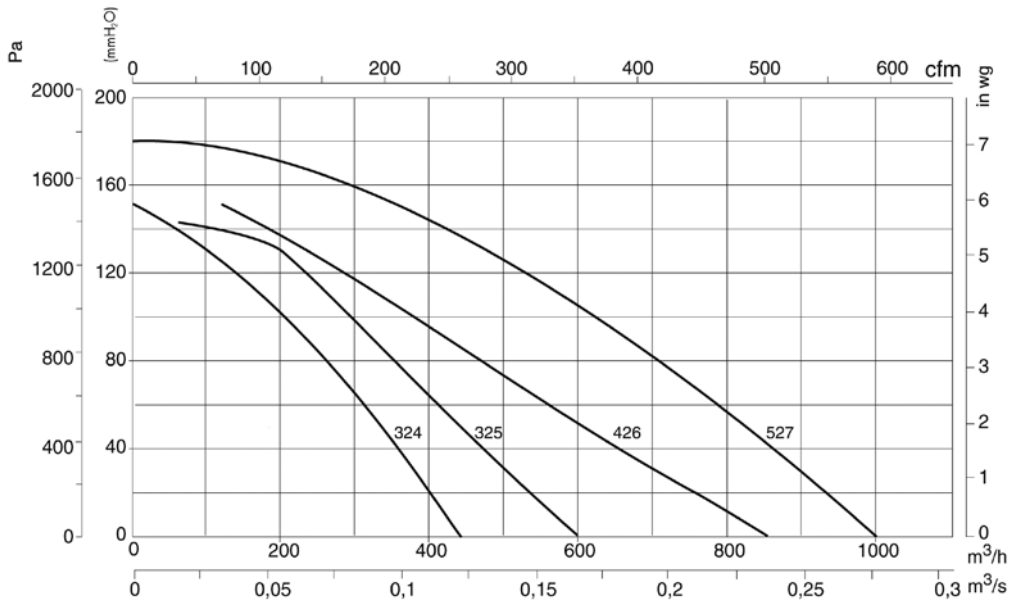

**Accesorios**

Ver apartado accesorios.



# CMP/ATEX *Extractores centrífugos de media presión equipados con turbina multipala, con certificación ATEX*



Bajo demanda versión ATEX construcción en acero inoxidable

Extractores centrífugos de media presión y simple aspiración con envolvente y turbina en chapa de acero, para trabajar en atmósferas explosivas.

**Ventilador:**

- Envolvente en chapa de acero
- Turbina con álabes hacia delante, en chapa de acero galvanizado
- Aro de aspiración antichispas en cobre o aluminio
- Temperatura máxima del aire a transportar: -20°C.+ 80°C.

**Motor:**

- Motores clase F, con rodamientos a bolas, protección IP55, con certificación ATEX, antiexplosivos Ex"e" o antideflagrantes Ex"d"
- Trifásicos 230/400V.-50Hz.(hasta 4 kW) y 400/690V.-50Hz.(potencias superiores a 4 kW)

**Acabado:**

- Anticorrosivo con pintura ATEX, libre de componentes férricos, en resina de poliéster polimerizada a 190 °C, previo desengrase con tratamiento nanotecnológico libre de fosfatos

**Bajo demanda:**

- Motores con PTC incorporada
- Bobinados especiales para diferentes tensiones y frecuencias
- Construcción ATEX para diferentes categorías
- Construcción en acero inoxidable



Ex "e" marcado: C E (Ex) II 2G Ex e  
 Ex "d" marcado: C E (Ex) II 2G Ex d  
 Organismo notificado: L.O.M.  
 Ex tc marcado: C E (Ex) II 3D Ex tc  
 Ex tb marcado: C E (Ex) II 2D Ex tb  
**Nº de identificación:**  
**LOM04ATEX0007**

**Código de pedido**

**CMP/ATEX — 1128 — 2T — 5,5 — Ex-e**

Extractores centrífugos de media presión equipados con turbina multipala, con certificación ATEX

Tamaño turbina

Número de polos motor

2=2900 r/min. 50 Hz  
 4=1400 r/min. 50 Hz

T=Trifásico

Potencia motor (c.v)

Ex-e: marcado: C E (Ex) II 2G Ex e IIB T3  
 Ex "d" marcado: C E (Ex) II 2G Ex d IIB T5  
 Ex tc marcado: C E (Ex) II 3D Ex tc  
 Ex tb marcado: C E (Ex) II 2D Ex tb

**Markado:**

C E (Ex) II 2G c  
 C E (Ex) II 2D c  
 C E (Ex) II 3D c

**Características técnicas**

Modelo	Velocidad (r/min)	Intensidad máxima (A)			Potencia instalada (kW)	Caudal máximo (m³/h)	Nivel presión sonora dB(A)	Peso aprox. con motor (Kg)	
		230V	400V	690V				Ex-e	Ex-d
CMP-616-2T/ATEX	2710	2,94	1,70		0,55	1380	69	9	19
CMP-616-4T/ATEX	1320	0,65	0,38		0,09	850	61	9	16
CMP-620-2T/ATEX	2770	2,08	1,20		0,37	765	68	11	21
CMP-620-4T/ATEX	1320	0,65	0,38		0,09	810	61	9	16
CMP-718-2T/ATEX	2820	3,46	2,00		0,75	1485	70	14	26
CMP-718-4T/ATEX	1370	2,08	1,20		0,25	1280	63	11	20
CMP-820-2T/ATEX	2850	4,50	2,60		1,10	1950	73	18	31
CMP-820-4T/ATEX	1370	2,08	1,20		0,25	1670	66	12	21
CMP-922-2T-1,5/ATEX	2850	4,50	2,60		1,10	1650	70	23	36
CMP-922-2T-2/ATEX	2800	6,24	3,60		1,50	2010	71	24	43
CMP-922-2T-3/ATEX	2860	8,66	5,00		2,20	2600	74	27	48
CMP-922-4T/ATEX	1410	2,94	1,70		0,55	2450	66	20	34
CMP-1025-2T-3/ATEX	2860	8,66	5,00		2,20	2100	73	29	50
CMP-1025-2T-4/ATEX	2845	12,12	7,00		3,00	2830	77	34	58
CMP-1025-4T/ATEX	1410	5,20	3,00		1,10	3400	70	27	46
CMP-1128-2T-4/ATEX	2845	12,12	7,00		3,00	2220	77	37	61
CMP-1128-2T-5,5/ATEX	2910	15,42	8,90		4,00	3210	81	41	62
CMP-1128-4T/ATEX	1410	9,01	5,20		2,20	5000	74	37	60
CMP-1231-4T-3/ATEX	1410	9,01	5,20		2,20	4740	73	46	69
CMP-1231-4T-4/ATEX	1440	12,30	7,10		3,00	5910	75	49	72

**Características técnicas**

Modelo	Velocidad (r/min)	Intensidad máxima (A)			Potencia instalada (kW)	Caudal máximo (m³/h)	Nivel presión sonora dB(A)	Peso aprox. con motor (Kg)	
		230V	400V	690V				Ex-e	Ex-d
CMP-1231-4T-5,5/ATEX	1450	15,76	9,10		4,00	6850	77	53	77
CMP-1435-4T-4/ATEX	1440	12,30	7,10		3,00	5560	76	54	77
CMP-1435-4T-5,5/ATEX	1450	15,76	9,10		4,00	6260	78	61	85
CMP-1435-4T-7,5/ATEX	1440		12,00	6,93	5,50	7210	80	74	113
CMP-1640-4T-5,5/ATEX	1450	15,76	9,10		4,00	7000	77	79	103
CMP-1640-4T-7,5/ATEX	1440		12,00	6,93	5,50	8035	80	92	131
CMP-1640-4T-10/ATEX	1448		16,30	9,41	7,50	9710	82	100	134
CMP-1845-4T-7,5/ATEX	1440		12,00	6,93	5,50	8000	82	94	133
CMP-1845-4T-10/ATEX	1448		16,30	9,41	7,50	10000	85	102	136
CMP-2050-4T-10/ATEX	1448		16,30	9,41	7,50	9000	83	135	169
CMP-2050-4T-15/ATEX	1460		23,80	13,74	11,00	12525	87	162	259
CMP-2050-4T-20/ATEX	1450		30,60	17,67	15,00	16500	89	181	282

**Características acústicas**

Los valores indicados, se determinan mediante medidas de nivel de presión y potencia sonora en dB(A) obtenidas en campo libre a una distancia equivalente a dos veces la envergadura del ventilador más el diámetro de la turbina, con un mínimo de 1,5 mts.

**Espectro de potencia sonora Lw(A) en dB(A) banda de frecuencia en [Hz]**

Modelo	Lp dB (A)	63	125	250	500	1000	2000	4000	8000	Modelo	Lp dB (A)	63	125	250	500	1000	2000	4000	8000
CMP-616-2T/ATEX	69	44	54	65	72	76	73	71	64	CMP-1128-2T-5,5/ATEX	81	56	66	77	84	88	85	83	76
CMP-616-4T/ATEX	61	36	46	57	64	68	65	63	56	CMP-1128-4T/ATEX	74	49	59	70	77	81	78	76	69
CMP-620-2T/ATEX	68	43	53	64	71	75	72	70	63	CMP-1231-4T-3/ATEX	73	51	60	71	78	82	80	78	71
CMP-620-4T/ATEX	61	36	46	57	64	68	65	63	56	CMP-1231-4T-4/ATEX	75	53	62	73	80	84	82	80	73
CMP-718-2T/ATEX	70	45	55	66	73	77	74	72	65	CMP-1231-4T-5,5/ATEX	77	55	64	75	82	86	84	82	75
CMP-718-4T/ATEX	63	38	48	59	66	70	67	65	58	CMP-1435-4T-4/ATEX	76	54	63	74	81	85	83	81	74
CMP-820-2T/ATEX	73	48	58	69	76	80	77	75	68	CMP-1435-4T-5,5/ATEX	78	56	65	76	83	87	85	83	76
CMP-820-4T/ATEX	66	41	51	62	69	73	70	68	61	CMP-1435-4T-7,5/ATEX	80	58	67	78	85	89	87	85	78
CMP-922-2T-1,5/ATEX	70	45	55	66	73	77	74	72	65	CMP-1640-4T-5,5/ATEX	77	55	64	75	82	86	84	82	75
CMP-922-2T-2/ATEX	71	46	56	67	74	78	75	73	66	CMP-1640-4T-7,5/ATEX	80	58	67	78	85	89	87	85	78
CMP-922-2T-3/ATEX	74	49	59	70	77	81	78	76	69	CMP-1640-4T-10/ATEX	82	60	69	80	87	91	89	87	80
CMP-922-4T/ATEX	66	41	51	62	69	73	70	68	61	CMP-1845-4T-7,5/ATEX	82	61	71	82	89	93	91	89	81
CMP-1025-2T-3/ATEX	73	48	58	69	76	80	77	75	68	CMP-1845-4T-10/ATEX	85	64	74	85	92	96	94	92	84
CMP-1025-2T-4/ATEX	77	52	62	73	80	84	81	79	72	CMP-2050-4T-10/ATEX	83	62	72	83	90	94	92	90	82
CMP-1025-4T/ATEX	70	45	55	66	73	77	74	72	65	CMP-2050-4T-15/ATEX	87	66	76	87	94	98	96	94	86
CMP-1128-2T-4/ATEX	77	52	62	73	80	84	81	79	72	CMP-2050-4T-20/ATEX	89	68	78	89	96	100	98	96	88

**Dimensiones mm**

**CMP-616...820**

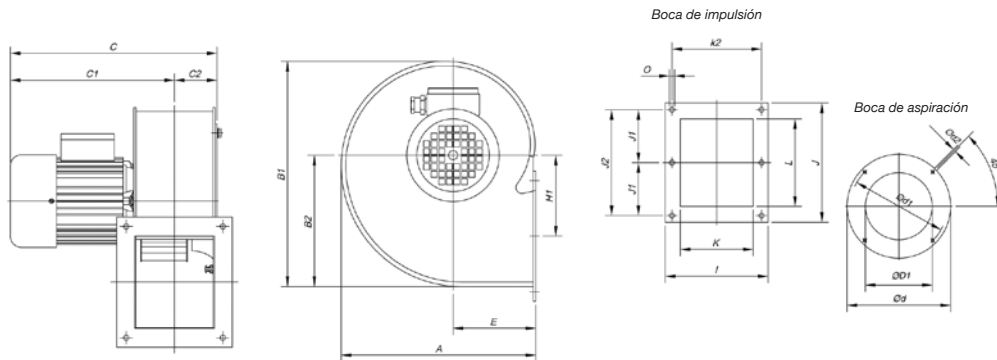

Modelo	A	B1	B2	C	C1	C2	øD1*	ød	ød1	ød2	E	H1	I	J	J1	J2	K	k2	L	øO
CMP-616-2T/ATEX	258	297	173,5	320	264	56	160	204	180	M6	110	105,5	153	172	-	147	103	128	122	7
CMP-616-4T/ATEX	258	297	173,5	283	227	56	160	204	180	M6	110	105,5	153	172	-	147	103	128	122	7
CMP-620-2T/ATEX	298	347	202,5	321	265	56	200	247	230	M6	126	145,5	159	153	-	128	105	134	100	8
CMP-620-4T/ATEX	298	347	202,5	283	227	56	200	247	230	M6	126	145,5	159	153	-	128	105	134	100	8
CMP-718-2T/ATEX	303,5	348	201	355	294	61	180	238	210	M6	129,5	122	169	192	85	170	115	145	146	9
CMP-718-4T/ATEX	303,5	348	201	331	270	61	180	238	210	M6	129,5	122	169	192	85	170	115	145	146	9
CMP-820-2T/ATEX	322	377	223	369,5	301	68,5	200	247	230	M6	137,5	137	184	213	94,5	189	130	160	156	9
CMP-820-4T/ATEX	322	377	223	345,5	277	68,5	200	247	230	M6	137,5	137	184	213	94,5	189	130	160	156	9

Dimensiones mm

CMP-616...820

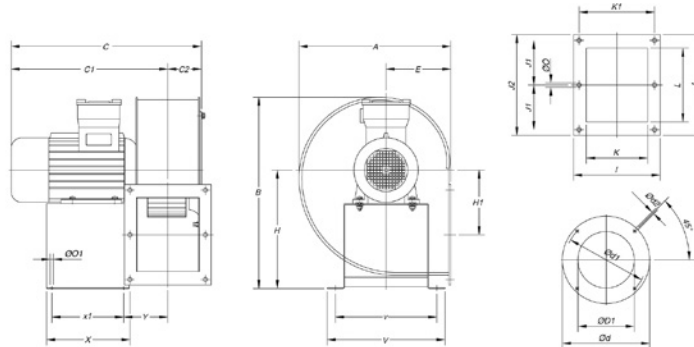

Modelo	A	B	C	C1	C2	øD1	ød	ød1	ød2	E	H	H1	I	J	J1	J2	K	k1	L	øO	øO1	V	v	X	x1	Y
CMP (Ex-d)-616-2T	258	400	376	318.5	57.5	160	204	180	M.6	109.5	251	107	153	172	-	147	103	128	125	7	9	250	215	175	145	83.5
CMP (Ex-d)-616-4T	258	380	346	288.5	57.5	160	204	180	M.6	109.5	243	107	153	172	-	147	103	128	125	7	9	250	215	175	145	78.5
CMP (Ex-d)-620-2T	298	400	376	320	56	200	247	230	M.6	126	251	145.5	159	153	-	128	105	134	100	8	9	250	215	175	145	84.5
CMP (Ex-d)-620-4T	298	388	346	290	56	200	247	230	M.6	126	243	145.5	159	153	-	128	105	134	100	9	9	250	215	175	145	79.5
CMP (Ex-d)-718-2T	303.5	440	396	335	61	180	238	210	M.6	129.5	260	122	169	192	85	170	115	145	146	9	9	250	215	175	145	94.5
CMP (Ex-d)-718-4T	303.5	400	386	325	61	180	238	210	M.6	129.5	251	122	169	192	85	170	115	145	146	9	9	250	215	175	145	94.5
CMP (Ex-d)-820-2T	322	440	415	343.5	71.5	200	247	230	M.6	137.5	260	137	184	213	94.5	189	130	160	156	9	9	250	215	175	145	102
CMP (Ex-d)-820-4T	322	405	403	331.5	71.5	200	247	230	M.6	137.5	251	137	184	213	94.5	189	130	160	156	9	9	250	215	175	145	97

CMP-922...1231

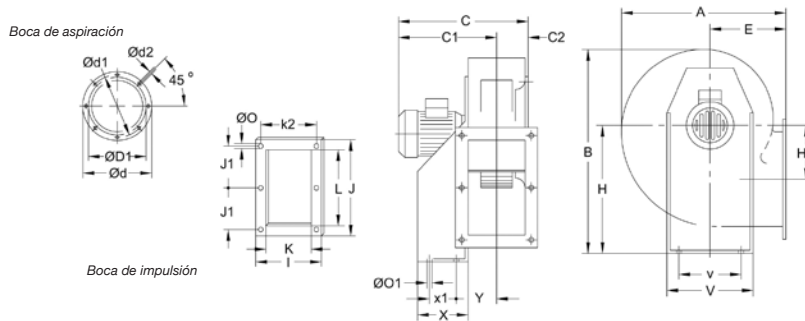

Modelo	Ex-"e"		Ex-"d"		øD1*	ød	ød1	ød2	E	H	H1	I	J	J1	K	k2	L	øO	øO1	V	v	X	x1	Y			
	A	B	C	C1																							
CMP-922-2T-1.5/ATEX	388.5	455	382	309	424	351	73,5	224	278	256	M.8	180	280	134	204	282,5	128	140	180	215	9,5	10,5	290	220	114	50	105
CMP-922-2T-2/ATEX	388.5	455	423,5	350	430,5	357	73,5	224	278	256	M.8	180	280	134	204	282,5	128	140	180	215	9,5	10,5	290	220	114	50	105
CMP-922-2T-3/ATEX	388.5	455	423,5	350	430,5	357	73,5	224	278	256	M.8	180	280	134	204	282,5	128	140	180	215	9,5	10,5	290	220	114	50	105
CMP-922-4T/ATEX	388.5	455	382,5	309	424	351	73,5	224	278	256	M.8	180	280	134	204	282,5	128	140	180	215	9,5	10,5	290	220	114	50	105
CMP-1025-2T-3/ATEX	427	503	456	370	466	380	86	250	305	282	M.8	197	310	144	229	312,5	145	165	205	250	9,5	12,5	315	228	134	74	115,5
CMP-1025-2T-4/ATEX	427	503	486	400	516	430	86	250	305	282	M.8	197	310	144	229	312,5	145	165	205	250	9,5	12,5	315	228	134	74	115,5
CMP-1025-4T/ATEX	427	503	456	370	466	380	86	250	305	282	M.8	197	310	144	229	312,5	145	165	205	250	9,5	12,5	315	228	134	74	115,5
CMP-1128-2T-4/ATEX	472	553	493,5	400	532,5	434	93,5	280	348	320	M.8	216	340	152	244	364	170	180	220	296,5	9,5	12,5	348	245	144	95	122,5
CMP-1128-2T-5.5/ATEX	472	553	553,5	451	553,5	451	93,5	280	348	320	M.8	216	340	152	244	364	170	180	220	296,5	9,5	12,5	348	245	144	95	122,5
CMP-1128-4T/ATEX	472	553	493,5	400	532,5	434	93,5	280	348	320	M.8	216	340	152	244	364	170	180	220	296,5	9,5	12,5	348	245	144	95	122,5
CMP-1231-4T-3/ATEX	526	630	520,5	417	547,5	444	103,5	315	382	354	M.8	238	390	179,5	264	382,5	180	200	240	320	11,5	13	382	322	183	140	126
CMP-1231-4T-4/ATEX	526	630	520,5	417	547,5	444	103,5	315	382	354	M.8	238	390	179,5	264	382,5	180	200	240	320	11,5	13	382	322	183	140	126
CMP-1231-4T-5.5/ATEX	526	630	543,5	440	576,5	434	103,5	315	382	354	M.8	238	390	179,5	264	382,5	180	200	240	320	11,5	13	382	322	183	140	126

\*Diámetro nominal tubería recomendada



Dimensiones mm

CMP-1435...2050

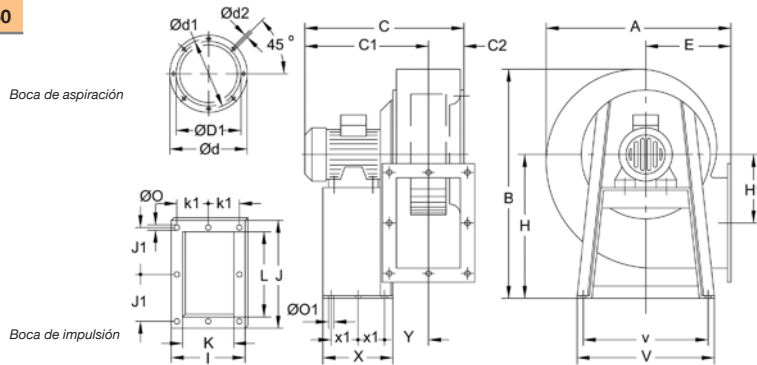

Modelo	Ex-"e"		Ex-"d"				C2	øD1*	ød	ød1	ød2	E	H	H1	I	J	J1	K	k1	L	øO	øO1	V	v	X	x1	Y
	A	B	C	C1	C	C1																					
CMP-1435-4T-4/ATEX	573,5	715	527	409	577	459	118	355	422	394	M.8	250	445	242,5	292	342,5	159	228	133	280	11,5	12	456	420	333	136,5	150
CMP-1435-4T-5,5/ATEX	573,5	715	572	545	597	479	118	355	422	394	M.8	250	445	242,5	292	342,5	159	228	133	280	11,5	12	456	420	333	136,5	150
CMP-1435-4T-7,5/ATEX	573,5	715	610	492	670	552	118	355	422	394	M.8	250	445	242,5	292	342,5	159	228	133	280	11,5	12	456	420	333	136,5	150
CMP-1640-4T-5,5/ATEX	634	799	596	465	621	491	130	400	464	438	M.8	270	495	271	336	404	185	250	150	321	11,5	12	500	460	327	133,5	162,5
CMP-1640-4T-7,5/ATEX	634	799	634	504	693	563	130	400	464	438	M.8	270	495	271	336	404	185	250	150	321	11,5	12	500	460	327	133,5	162,5
CMP-1640-4T-10/ATEX	634	799	634	504	693	563	130	400	464	438	M.8	270	495	271	336	404	185	250	150	321	11,5	12	500	460	327	133,5	162,5
CMP-1845-4T-7,5/ATEX	711	901	668	521	727	580	147	450	515	485	M.8	302	560	305	370	444	202	284	164	361	11,5	12	538	502	340	140	179,5
CMP-1845-4T-10/ATEX	711	901	668	521	727	580	147	450	515	485	M.8	302	560	305	370	444	202	284	164	361	11,5	12	538	502	340	140	179,5
CMP-2050-4T-10/ATEX	797	987	700,5	538	759	596,5	162,5	500	565	535	M.10	345	610	313	411	544	250	315	182,5	451	11,5	12	653	615	435	188	196
CMP-2050-4T-15/ATEX	797	987	818,5	656	923,5	764,5	162,5	500	565	535	M.10	345	610	313	411	544	250	315	182,5	451	11,5	12	653	615	435	188	196
CMP-2050-4T-20/ATEX	797	987	859,5	697	923,5	764,5	162,5	500	565	535	M.10	345	610	313	411	544	250	315	182,5	451	11,5	12	653	615	435	188	196

\*Diámetro nominal tubería recomendada

Curvas Características

Ver página 162

Orientaciones

Suministro standard LG 270

Posiciones LG 180 y RD 180 bajo demanda y con medidas de anclaje especiales.

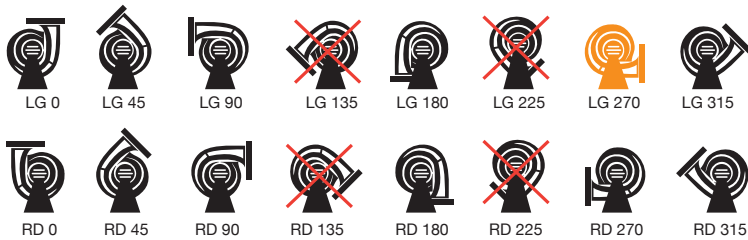

Accesorios

Ver apartado accesorios.





## CMP/ATEX

**Extractores centrífugos de media presión equipados con turbina multipala, con certificación ATEX**

Extractores centrífugos de media presión y simple aspiración con envolvente y turbina en chapa de acero, para trabajar en atmósferas explosivas.



## CMP/MAR

**Extractores centrífugos de media presión equipados con turbina multipala para aplicaciones marinas**

Extractores centrífugos de media presión y simple aspiración con envolvente y turbina en chapa de acero, para trabajar en ambientes marinos y equipados con motor para servicio marino



## CMPI

**Extractores centrífugos de media presión equipados con turbina multipala construidos en acero inoxidable AISI-304**

Extractores centrífugos de media presión y simple aspiración con envolvente y turbina en chapa de acero inoxidable, para trabajar en ambientes químicos, agresivos o marinos



Curvas características

CMP/ATEX CMP/MAR CMPI

Q= Caudal en m<sup>3</sup>/h, m<sup>3</sup>/s y cfm.

Pe= Presión estática en mmH<sub>2</sub>O, Pa e inwg.

512...820

2T/2M=3000 r/min

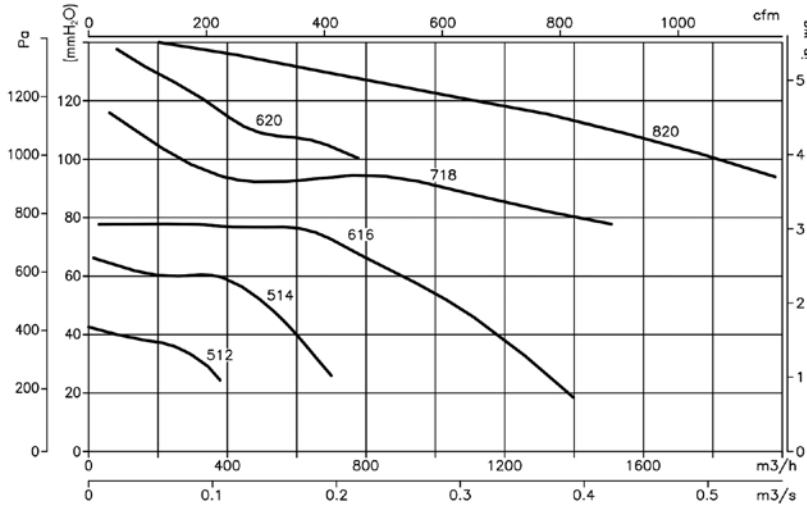

4T/4M=1500 r/min

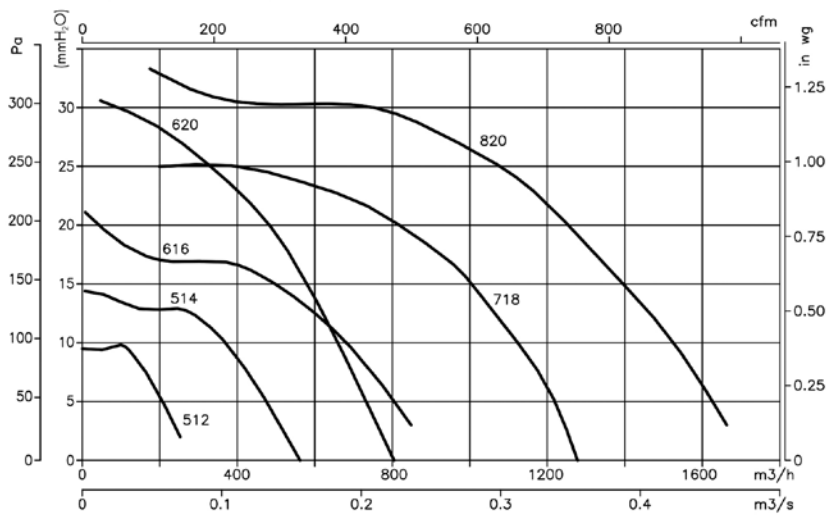

922...1231

2T=3000 r/min

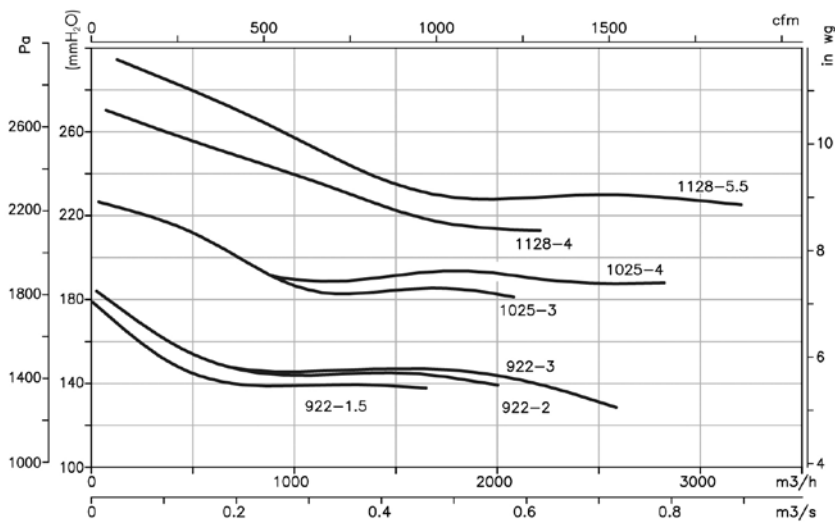

Curvas características

CMP/ATEX CMP/MAR CMPI

Q= Caudal en m<sup>3</sup>/h, m<sup>3</sup>/s y cfm.

Pe= Presión estática en mmH<sub>2</sub>O, Pa e inwg.

4T=1500 r/min 6T=1000 r/min

922...1231

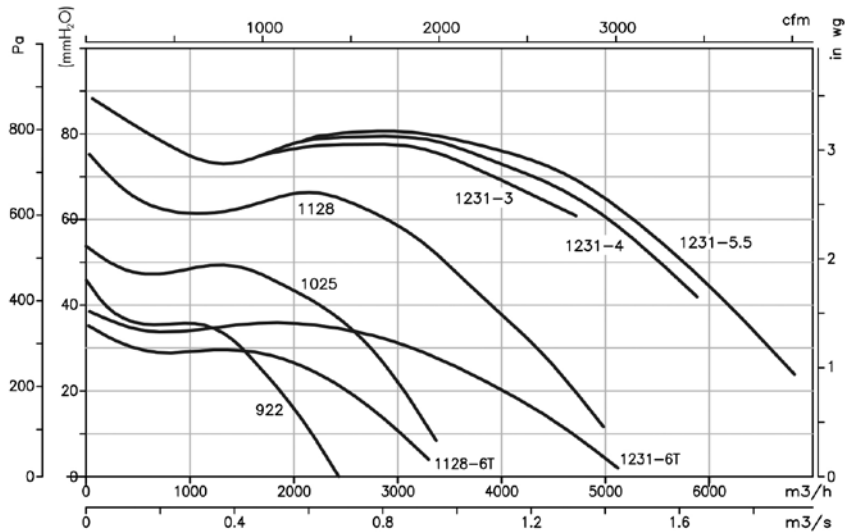

1435...2563

4T=1500 r/min

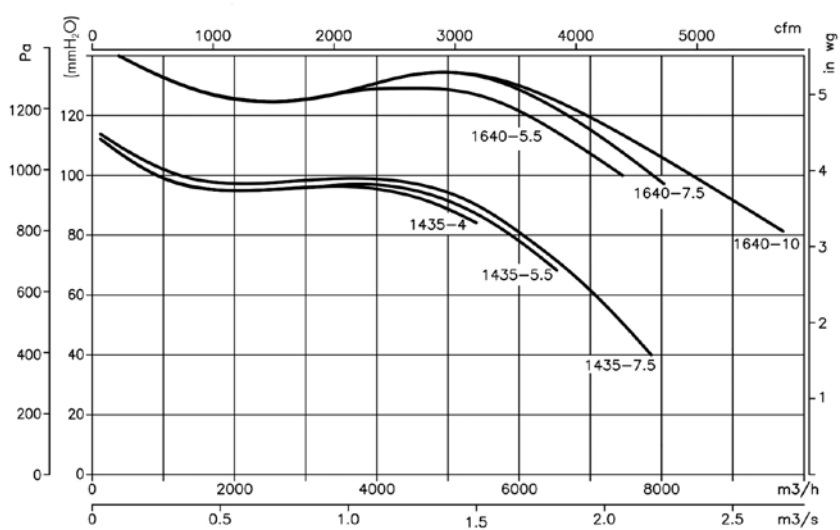

Curvas características

CMP/ATEX CMP/MAR CMPI

Q= Caudal en m<sup>3</sup>/h, m<sup>3</sup>/s y cfm.

Pe= Presión estática en mmH<sub>2</sub>O, Pa e inwg.

1435...2563

4T=1500 r/min

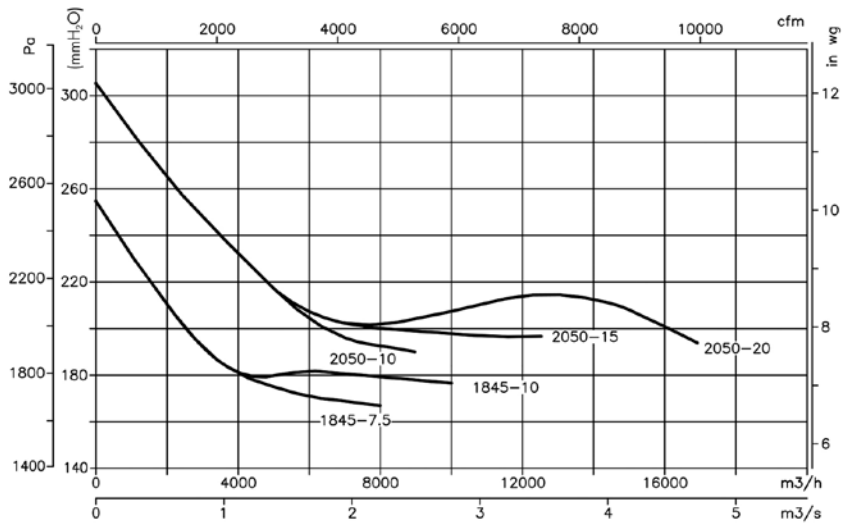

6T=1000 r/min

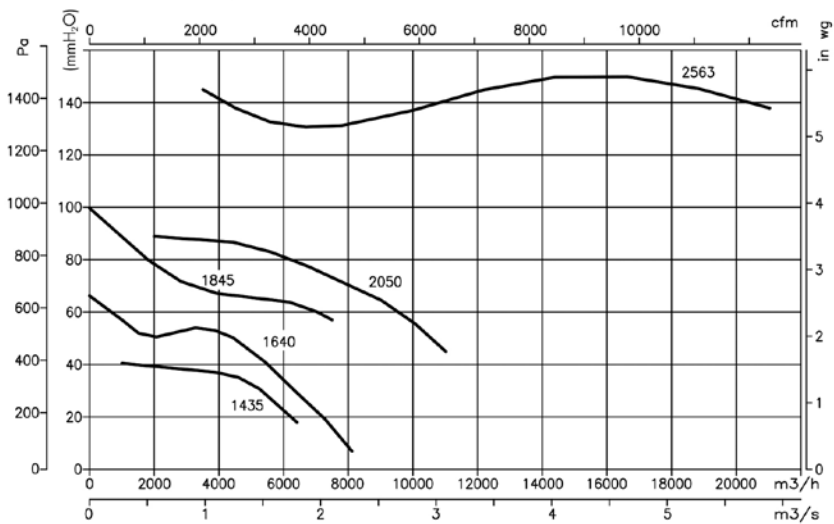

# CMP/AL CJMP/AL

**CMP/AL: Ventiladores antichispas en aluminio con certificado de cumplimiento de la norma UNE-60601-2013 y de acuerdo a las necesidades en salas de calderas de gas natural**  
**CJMP/AL: Unidades de Ventilación antichispas en aluminio con certificado de cumplimiento de la norma UNE-60601-2013 y de acuerdo a las necesidades en salas de calderas de gas natural**



Rodetes de aluminio equilibrados dinámicamente con núcleos de gran robustez

**Ventilador:**

- Turbina con álabes hacia delante, en chapa de aluminio
- CMP/AL: Envoltorio en chapa de aluminio
- CJMP/AL: Estructura en chapa de acero galvanizado

**Motor:**

- Motores clase F, con rodamientos a bolas, protección IP55
- Monofásicos 230V.-50Hz.
- Temperatura máxima del aire a transportar: -20°C.+ 120°C.

**Acabado:**

- CMP/AL: Anticorrosivo en resina de poliéster polimerizada a 190 °C, previo desengrase con tratamiento nanotecnológico libre de fosfatos.
- CJMP/AL: Anticorrosivo en chapa de acero galvanizado

**Bajo demanda:**

- Bobinados especiales para diferentes tensiones
- Certificación ATEX Categoría 2

**Código de pedido**

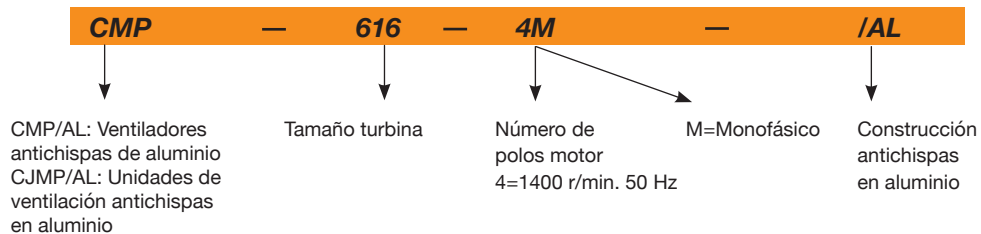

**Características técnicas**

Modelo	Velocidad (r/min)	Intensidad máxima admisible (A)	Potencia instalada	Caudal máximo	Nivel sonoro	Peso aprox.
		230V	(kW)	(m <sup>3</sup> /h)	dB(A)	(Kg)
CMP-512-4M/AL	1370	0,83	0,09	275	55	3,5
CMP-514-4M/AL	1370	0,83	0,09	660	58	4,5
CMP-616-4M/AL	1370	0,83	0,09	1000	61	7,5
CMP-820-4M/AL	1370	2,00	0,25	2100	66	10,0
CJMP-512-4M/AL	1370	0,83	0,09	275	50	8,5
CJMP-514-4M/AL	1370	0,83	0,09	660	54	10,5
CJMP-616-4M/AL	1370	0,83	0,09	1000	57	14,5
CJMP-820-4M/AL	1370	2,00	0,25	2100	60	18,0

Dimensiones mm

CMP/AL-512...820

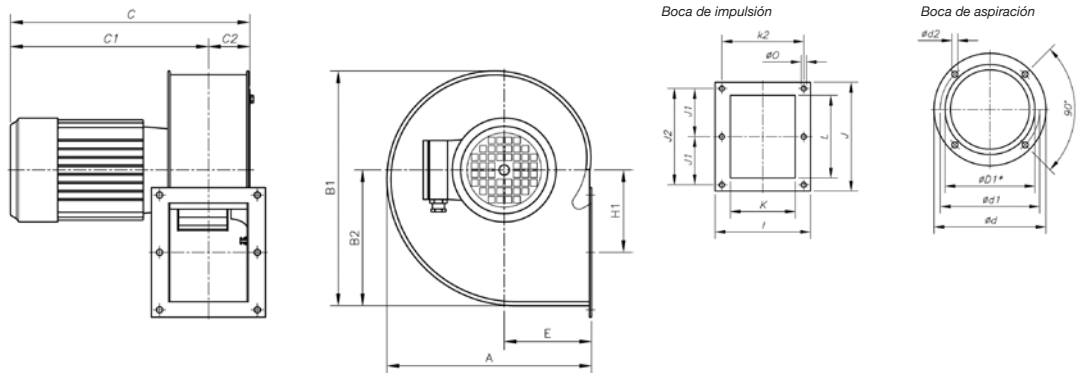

Modelo	A	B1	B2	C	C1	C2	øD1*	ød	ød1	ød2	E	H1	I	J	J1	J2	K	k2	L	øO
CMP-512-4M/AL	182	207	118	197,5	159	38,5	112	140	132	M4	81	69	106	118	-	105	72	93	86	5,5
CMP-514-4M/AL	225	254	150	210	165	45	140	169	151,5	M4	100	91	122	147	64	128	83	105	107	9,5
CMP-616-4M/AL	258	297	173,5	270	214	56	160	204	180	M6	110	105,5	153	172	-	147	103	128	125	7
CMP-820-4M/AL	322	377	223	345,5	277	68,5	200	247	230	M6	137,5	137	184	213	94,5	189	130	160	156	9

\* Diámetro nominal tubería recomendada

CJMP/AL-512...820

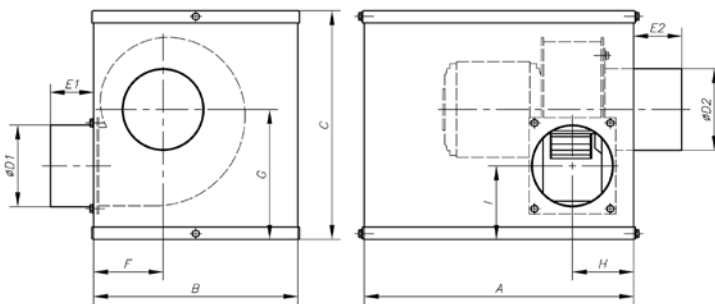

Modelo	A	B	C	øD1	øD2	E1	E2	F	G	H	I
CJMP/AL-512	330	250	280	100	100	53	59	85	159	75	90
CJMP/AL-514	330	270	320	125	125	53	58	104	190	82	100
CJMP/AL-616	370	300	370	135	135	53	52	114	217	100	110
CJMP/AL-820	450	400	450	135	195	53	51	142	267	112	130

Curvas Características

Q= Caudal en m³/h, m³/s y cfm.

Pe= Presión estática en mmH2O, Pa e inwg.

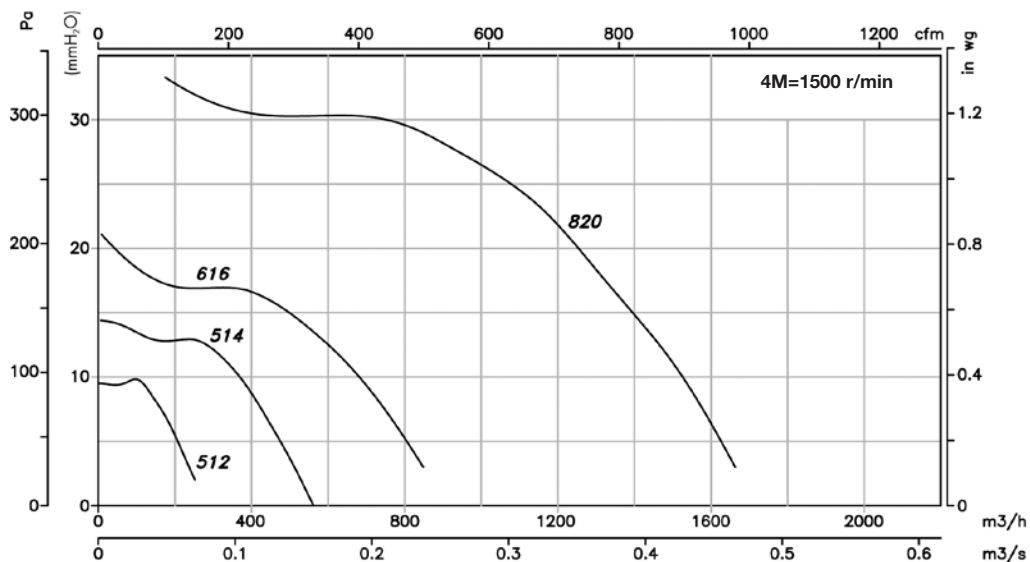

# CMR/ATEX *Extractores centrífugos de media presión y gran robustez, equipados con turbina a reacción, con certificación ATEX*



Extractores centrífugos de media presión y simple aspiración, de gran robustez, para trabajar en atmósferas explosivas.

**Ventilador:**

- Envoltente en chapa de acero
- Turbina con álabes a reacción, en chapa de acero de gran robustez
- Aro de aspiración antichispas en cobre o aluminio

**Motor:**

- Motores clase F, con rodamientos a bolas, protección IP55, con certificación ATEX, antiexplosivos Ex"e" o antideflagrantes Ex"d"
- Trifásicos 230/400V.-50Hz.(hasta 4 kW) y 400/690V.-50Hz.(potencias superiores a 4 kW)
- Temperatura máxima del aire a transportar: -20°C.+ 80°C.



Ex "e" marcado: C<sup>Ⓢ</sup>Ex II 2G Ex e  
 Ex "d" marcado: C<sup>Ⓢ</sup>Ex II 2G Ex d  
 Ex tc marcado: C<sup>Ⓢ</sup>Ex II 3D Ex tc  
 Ex tb marcado: C<sup>Ⓢ</sup>Ex II 2D Ex tb  
**Organismo notificado: L.O.M.**  
**Nº de identificación: LOM3ATEX147**

**Acabado:**

- Anticorrosivo con pintura ATEX, libre de componentes férricos, en resina de poliéster polimerizada a 190 °C, previo desengrase con tratamiento nanotecnológico libre de fosfatos

**Bajo demanda:**

- Motores con PTC incorporada
- Bobinados especiales para diferentes tensiones y frecuencias
- Construcción ATEX para diferentes categorías
- Construcción en acero inoxidable

**Código de pedido**



Extractores centrífugos de media presión y gran robustez, equipados con turbina a reacción, con certificación ATEX

**Markado:**  
 C<sup>Ⓢ</sup>Ex II 2G c  
 C<sup>Ⓢ</sup>Ex II 2D c  
 C<sup>Ⓢ</sup>Ex II 3D c

Tamaño turbina

Número de polos motor  
 2=2900 r/min. 50 Hz  
 4=1400 r/min. 50 Hz  
 6=900 r/min. 50 Hz

T=Trifásico

Potencia motor (c.v)

Ex-e: marcado: C<sup>Ⓢ</sup>Ex II 2G Ex e IIB T3  
 Ex "d" marcado: C<sup>Ⓢ</sup>Ex II 2G Ex d IIB T5  
 Ex tc marcado: C<sup>Ⓢ</sup>Ex II 3D Ex tc  
 Ex tb marcado: C<sup>Ⓢ</sup>Ex II 2D Ex tb

**Características técnicas**

Modelo	Velocidad (r/min)	Intensidad máxima (A)			Potencia instalada (kW)	Caudal máximo (m³/h)	Nivel presión sonora dB(A)	Peso aprox. con motor (Kg)	
		230V	400V	690V				Ex-e	Ex-d
CMR-1240-4T/ATEX	1410	3,81	2,20		0,75	5800	71	70	84
CMR-1445-2T/ATEX	2880		15,70	9,06	7,50	16500	87	141	163
CMR-1445-4T/ATEX	1410	5,20	3,00		1,10	8030	72	93	112
CMR-1650-2T/ATEX	2930		22,00	12,70	11,00	18850	89	178	258
CMR-1650-4T/ATEX	1400	6,93	4,00		1,50	10500	74	114	134
CMR-1650-6T/ATEX	930	4,16	2,40		0,75	7410	64	111	130
CMR-1856-4T/ATEX	1440	12,30	7,10		3,00	15150	79	152	175
CMR-1856-6T/ATEX	910	5,89	3,40		1,10	10050	70	145	166
CMR-2063-4T/ATEX	1440		12,00	6,93	5,50	24450	80	225	264
CMR-2063-6T/ATEX	940	7,62	4,40		1,50	16100	71	209	233
CMR-2271-4T/ATEX	1460		23,80	13,74	11,00	34610	85	315	412
CMR-2271-6T/ATEX	945	14,72	8,50		3,00	22750	76	280	320
CMR-2380-4T/ATEX	1465		42,00	24,00	22,00	48000	83	416	495
CMR-2380-6T/ATEX	965		16,40	9,47	7,50	30000	75	363	441



**Características acústicas**

Los valores indicados, se determinan mediante medidas de nivel de presión y potencia sonora en dB(A) obtenidas en campo libre a una distancia equivalente a dos veces la envergadura del ventilador más el diámetro de la turbina, con un mínimo de 1,5 mts.

Espectro de potencia sonora Lw(A) en dB(A) banda de frecuencia en [Hz]

Modelo	Lp dB (A)	63	125	250	500	1000	2000	4000	8000	Modelo	Lp dB (A)	63	125	250	500	1000	2000	4000	8000
CMR-1240-4T/ATEX	71	56	70	76	79	79	80	70	59	CMR-1856-6T/ATEX	70	61	69	81	83	80	81	71	60
CMR-1445-2T/ATEX	87	73	85	83	95	93	97	99	89	CMR-2063-4T/ATEX	80	80	85	91	93	91	88	81	73
CMR-1445-4T/ATEX	72	59	72	78	83	80	83	78	64	CMR-2063-6T/ATEX	71	69	70	82	82	81	83	73	63
CMR-1650-2T/ATEX	89	73	81	85	99	97	99	99	88	CMR-2271-4T/ATEX	85	83	84	93	96	98	99	95	82
CMR-1650-4T/ATEX	74	64	74	82	84	83	85	76	66	CMR-2271-6T/ATEX	76	73	73	87	86	90	90	79	68
CMR-1650-6T/ATEX	64	53	65	72	77	73	69	62	54	CMR-2380-4T/ATEX	83	76	78	94	91	96	97	93	82
CMR-1856-4T/ATEX	79	69	78	91	87	90	91	85	71	CMR-2380-6T/ATEX	75	68	70	86	83	88	89	85	74

**Dimensiones mm**

**CMR-1240...2271**

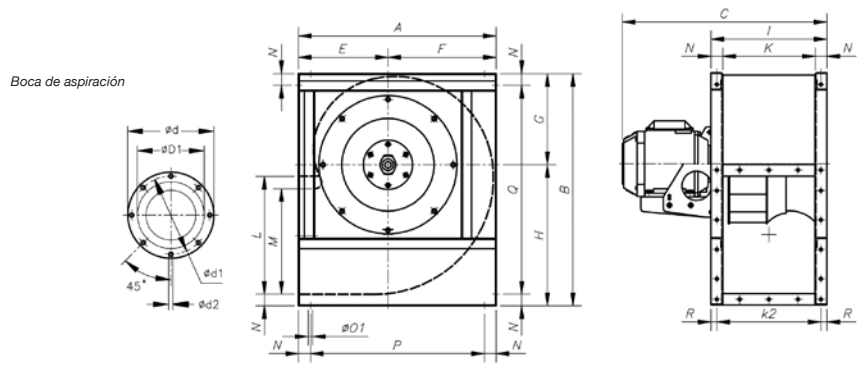

Modelo	A	B	C	C	ØD1*	Ød	Ød1	Ød2	E	F	G	H	I	K	k2	L	M	N	Ø01	P	Q	R
CMR-1240-4T/ATEX	673	790	596	638	400	472	444	M.10	305	368	310	480	395	315	355	400	358	40	11	593	710	20
CMR-1445-2T/ATEX	765	880	774	857	450	522	494	M.10	350	415	339	541	445	355	403	450	404	45	11	675	790	21
CMR-1445-4T/ATEX	765	880	679	687	450	522	494	M.10	350	415	339	541	445	355	403	450	404	45	11	675	790	21
CMR-1650-2T/ATEX	832	970	945,5	1018	500	582	555	M.10	375	457	378	592	490	400	450	500	445	45	13	742	880	20
CMR-1650-4T/ATEX	832	970	724,5	724,5	500	582	555	M.10	375	457	378	592	490	400	450	500	445	45	13	742	880	20
CMR-1650-6T/ATEX	832	970	724,5	724,5	500	582	555	M.10	375	457	378	592	490	400	450	500	445	45	13	742	880	20
CMR-1856-4T/ATEX	925	1084	798	889	560	645	615	M.10	415	510	426	658	550	450	500	560	493	50	13	825	984	25
CMR-1856-6T/ATEX	925	1084	780,5	809	560	645	615	M.10	415	510	426	658	550	450	500	560	493	50	13	825	984	25
CMR-2063-4T/ATEX	1037	1218	937	1020	630	720	688	M.10	465	572	477	741	620	500	560	630	530	60	13	917	1098	30
CMR-2063-6T/ATEX	1037	1218	839	930	630	720	688	M.10	465	572	477	741	620	500	560	630	530	60	13	917	1098	30
CMR-2271-4T/ATEX	1173	1375	1129	1201	710	800	768	M.12	525	648	538	837	690	560	625	710	603	65	13	1043	1245	32,5
CMR-2271-6T/ATEX	1173	1375	973	1056	710	800	768	M.12	525	648	538	837	690	560	625	710	603	65	13	1043	1245	32,5

\*Diámetro nominal tubería recomendada

**CMR-1240...2380**

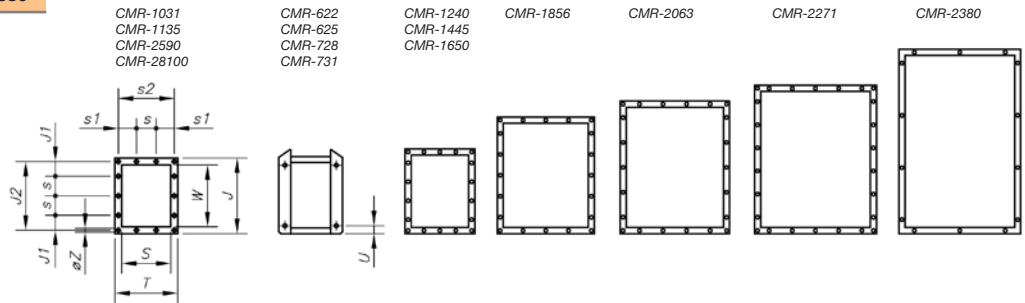

Modelo	T	J	J1	J2	S	s	s1	s2	W	Øz	U
CMR-1240	395	480	70	440	315	100	77,5	355	400	11	-
CMR-1445	445	540	99	498	355	100	102,5	403	450	11	-
CMR-1650	490	590	88	550	400	125	100	450	500	11	-
CMR-1856	550	660	55	610	450	125	125	500	560	13	-
CMR-2063	620	750	95	690	500	125	92,5	560	630	13	-
CMR-2271	690	840	75	775	560	125	62,5	625	710	13	-
CMR-2380	680	920	160	871	560	200	140	639	800	14	-

CMR-2380

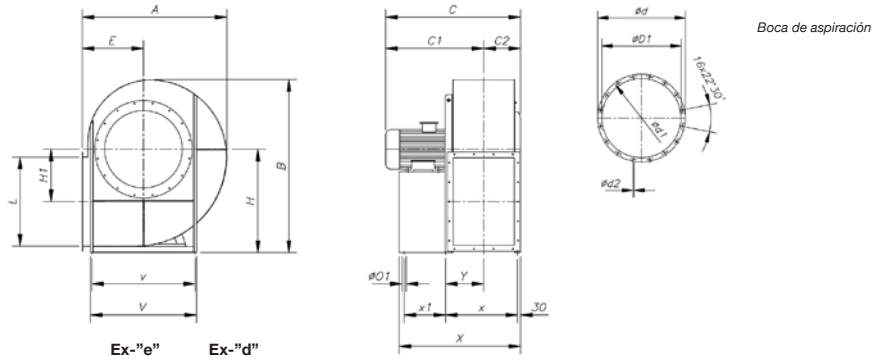

Modelo	A	B	C	C1	C	C1	C2	ØD1*	Ød	Ød1	Ød2	E	H	H1	L	Ø1	V	v	X	x	x1	Y
CMR-2380-4T/ATEX	1350	1660	1019	733	1063	777	286	808	906	861	11,5	560	1000	500	800	17	930	870	1102,5	667,5	370	352,5
CMR-2380-6T/ATEX	1350	1660	590	304	716	430	286	808	906	861	11,5	560	1000	500	800	17	930	870	1102,5	667,5	370	352,5

\*Diámetro nominal tubería recomendada

Curvas Características

Q= Caudal en m³/h, m³/s y cfm.

Pe= Presión estática en mmH2O, Pa e inwg.

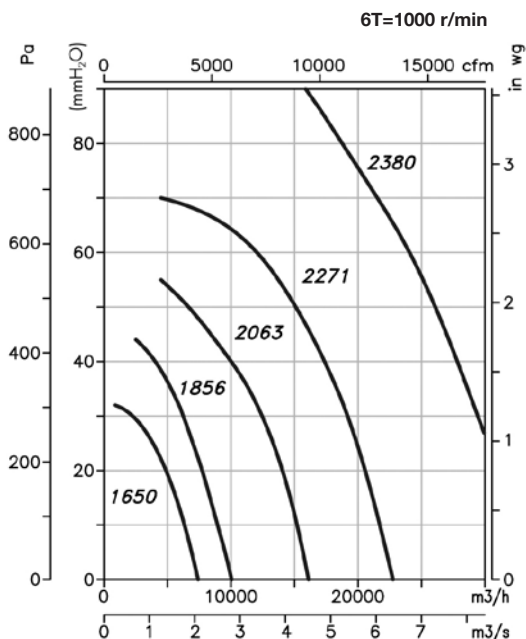
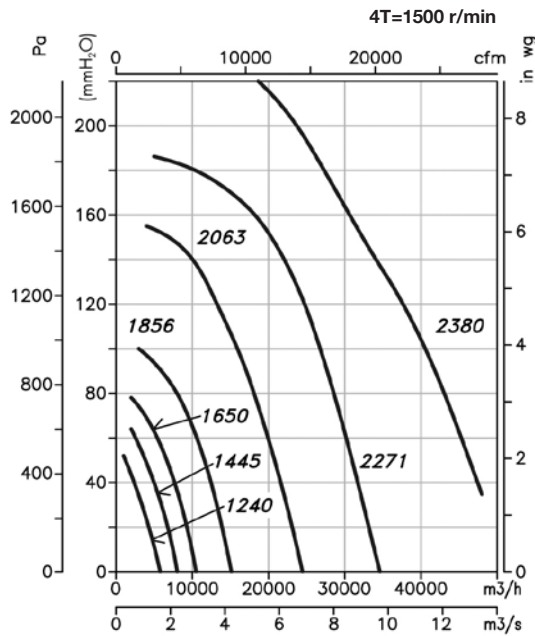
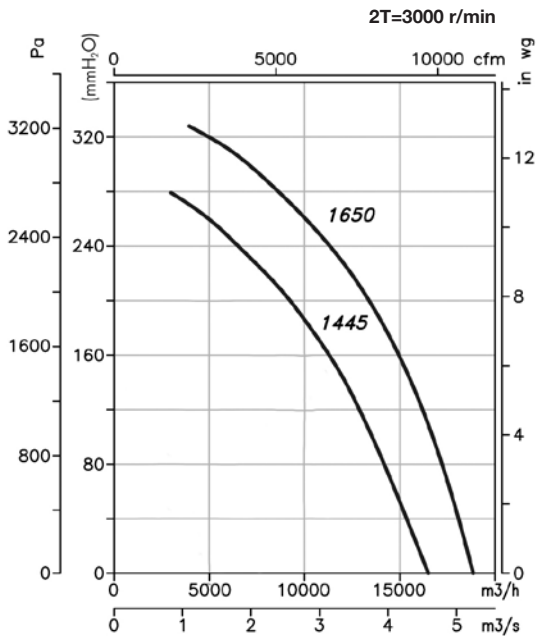

Orientaciones

Suministro standard LG 270



Accesorios

Ver apartado accesorios.



# CAS/ATEX

## Extractores centrífugos de alta presión y simple aspiración, con certificación ATEX



Extractores centrífugos de alta presión y Certificación ATEX con motor antiexplosivo CEE ExII2G Ex e, antideflagrante CEE ExII2G Ex d, Ex tc, o Ex tb para trabajar en atmósferas explosivas.

### Ventilador:

- Envoltorio en chapa de acero
- Turbina con álabes hacia atrás, en chapa de acero galvanizado, excepto modelos 242-248-254-260-640-645-650 con turbina en fundición de aluminio.
- Aro de aspiración antichispas en cobre o aluminio

### Motor:

- Motores clase F, con rodamientos a bolas con certificación ATEX, antiexplosivos Ex e, antideflagrante Ex d, Ex tc, o Ex tb
- Trifásicos 230/400V.-50Hz.(hasta 4 kW) y 400/690V.-50Hz.(potencias superiores a 4 kW)
- Temperatura máxima del aire a transportar: -20°C.+ 80°C.

### Acabado:

- Anticorrosivo con pintura ATEX, libre de componentes férricos, en resina de poliéster polimerizada a 190 °C, previo desengrase con tratamiento nanotecnológico libre de fosfatos

### Bajo demanda:

- Motores con PTC incorporada
- Bobinados especiales para diferentes tensiones y frecuencias
- Construcción ATEX para diferentes categorías
- Extractores con motor de 2 velocidades



Ex "e" marcado: CEE II 2G Ex e  
 Ex "d" marcado: CEE II 2G Ex d  
 Ex tc marcado: CEE II 3D Ex tc  
 Ex tb marcado: CEE II 2D Ex tb  
 Organismo notificado: L.O.M.  
 N° de identificación:  
 LOM4ATEX007

### Código de pedido



Markado:  
 CEE II 2G c  
 CEE II 2D c  
 CEE II 3D c

Ventiladores centrífugos de alta presión y simple aspiración con certificación ATEX

Tamaño turbina

Número de polos motor  
 2=2900 r/min. 50 Hz

T=Trifásico

Potencia motor (c.v.)

Ex-e: marcado: CEE II 2G Ex e IIB T3  
 Ex "d" marcado: CEE II 2G Ex d IIB T5  
 Ex tc marcado: CEE II 3D Ex tc  
 Ex tb marcado: CEE II 2D Ex tb

### Características técnicas

Modelo	Velocidad (r/min)	Intensidad máxima admisible (A)			Potencia instalada (kW)	Caudal máximo (m³/h)	Nivel presión sonora dB(A)	Peso aprox. (Kg)
		230V	400V	690V				
CAS/ATEX-242-2T-0,33	2740	1,73	1,00		0,25	450	73	30,0
CAS/ATEX-242-2T-0,5	2770	2,08	1,20		0,37	650	73	31,0
CAS/ATEX-248-2T-0,75	2710	2,94	1,70		0,55	420	74	43,5
CAS/ATEX-248-2T-1	2820	3,46	2,00		0,75	500	75	45,0
CAS/ATEX-248-2T-1,5	2850	4,50	2,60		1,10	990	76	46,5
CAS/ATEX-254-2T-1,5	2850	4,50	2,60		1,10	600	76	56,5
CAS/ATEX-254-2T-2	2800	6,24	3,60		1,50	800	78	61,5
CAS/ATEX-254-2T-3	2860	8,66	5,00		2,20	1300	80	63,0
CAS/ATEX-260-2T-2	2800	6,24	3,60		1,50	500	77	75,0
CAS/ATEX-260-2T-3	2860	8,66	5,00		2,20	900	79	78,0
CAS/ATEX-463-2T-5,5	2910	15,42	8,90		4,00	1150	82	88,5
CAS/ATEX-463-2T-7,5	2880		10,50	6,09	5,50	2000	83	95,5
CAS/ATEX-467-2T-7,5	2880		10,50	6,09	5,50	1550	84	117,5
CAS/ATEX-467-2T-10	2880		15,70	9,06	7,50	2600	85	122,5
CAS/ATEX-571-2T-10	2880		15,70	9,06	7,50	2000	86	144,0
CAS/ATEX-571-2T-15	2930		22,00	12,70	11,00	3450	87	175,0
CAS/ATEX-640-2T-2	2800	6,24	3,60		1,50	2600	77	51,5
CAS/ATEX-645-2T-3	2860	8,66	5,00		2,20	2000	76	62,5
CAS/ATEX-645-2T-4	2845	12,12	7,00		3,00	3000	81	69,5
CAS/ATEX-650-2T-5,5	2910	15,42	8,90		4,00	3500	81	89,0
CAS/ATEX-650-2T-7,5	2880		10,50	6,09	5,50	4750	83	96,0
CAS/ATEX-852-2T-7,5	2880		10,50	6,09	5,50	3500	81	96,0
CAS/ATEX-852-2T-10	2880		15,70	9,06	7,50	5500	85	101,0
CAS/ATEX-856-2T-15	2930		22,00	12,70	11,00	7500	85	157,5
CAS/ATEX-863-2T-15	2930		22,00	12,70	11,00	4000	84	168,0
CAS/ATEX-863-2T-20	2935		27,40	15,90	15,00	7000	86	179,0
CAS/ATEX-971-2T-25	2930		32,40	18,70	18,50	5800	87	299,0
CAS/ATEX-971-2T-30	2935		38,00	22,00	22,00	8100	88	324,0
CAS/ATEX-971-2T-40	2940		50,00	29,00	30,00	12000	89	380,0
CAS/ATEX-1250-2T-15/A	2930		22,00	12,70	11,00	12000	84	220,0

**Características técnicas**

Modelo	Velocidad (r/min)	Intensidad máxima admisible (A)			Potencia instalada (kW)	Caudal máximo (m³/h)	Nivel presión sonora dB(A)	Peso aprox. (Kg)
		230V	400V	690V				
CAS/ATEX-1456-2T-25/A	2930		32,40	18,70	18,50	18000	87	286,0
CAS/ATEX-1663-2T-50/A	2940		64,00	37,00	37,00	25000	92	425,0
CAS/ATEX-1671-2T-60/A	2940		76,00	44,00	45,00	27000	93	575,0
CAS/ATEX-2071-2T-100/A	2970		123,00	71,00	75,00	33600	95	750,0
CAS/ATEX-2080-2T-125/A	2970		151,00	87,00	90,00	42600	96	820,0
CAS/ATEX-790-2T-20	2935		27,40	15,90	15,00	2100	88	245,0
CAS/ATEX-980-2T-30	2935		38,00	22,00	22,00	4800	87	340,0
CAS/ATEX-990-2T-50	2940		64,00	37,00	37,00	6000	90	485,0
CAS/ATEX-1080-2T-40	2940		50,00	29,00	30,00	5400	88	420,0
CAS/ATEX-1090-2T-60	2940		76,00	44,00	45,00	6000	91	530,0

**Características acústicas**

Los valores indicados, se determinan mediante medidas de nivel de presión y potencia sonora en dB(A) obtenidas en campo libre a una distancia equivalente a dos veces la envergadura del ventilador más el diámetro de la turbina, con un mínimo de 1,5 mts.

Espectro de potencia sonora Lw(A) en dB(A) por banda de frecuencia en Hz

Modelo	63	125	250	500	1000	2000	4000	8000	Modelo	63	125	250	500	1000	2000	4000	8000
CAS									852-7,5	68	72	82	88	92	92	89	84
242	50	61	67	76	83	82	79	72	852-10	68	76	86	93	96	96	92	84
248-0,75	51	62	68	77	84	83	80	73	856	63	76	90	96	96	94	90	84
248-1	52	63	69	78	85	84	81	74	863-15	67	81	87	96	96	95	92	87
248-1,5	53	64	70	79	86	85	82	75	863-20	69	81	92	99	98	95	93	87
254-1,5	55	66	71	81	88	87	84	77	971-25	67	81	90	102	98	96	93	89
254-2	57	68	73	83	90	89	86	79	971-30	68	82	91	103	99	97	94	90
254-3	56	68	76	85	90	92	89	82	971-40	68	83	97	102	102	99	95	88
260-2	53	69	69	83	88	88	85	78	1250	75	88	97	94	91	86	82	73
260-3	55	71	71	85	90	90	87	80	1456	80	93	102	99	96	90	87	78
463-5,5	57	69	82	91	93	93	89	80	1663	65	74	80	95	108	100	97	93
463-7,5	58	70	83	92	94	94	90	81	1671	64	73	79	94	108	100	97	93
467-7,5	69	74	83	95	95	97	93	85	2071	66	75	81	96	110	102	99	95
467-10	70	75	84	96	96	98	94	86	2080	67	76	82	97	111	103	100	96
571-10	64	76	86	96	99	99	94	86	680	70	74	85	96	102	93	86	80
571-15	65	77	87	97	100	100	95	87	790	73	77	88	99	105	96	89	83
640	56	67	75	82	88	84	83	76	980	61	70	76	91	105	97	94	90
645-3	55	66	74	81	87	83	82	75	990	64	73	79	94	108	100	97	93
645-4	55	66	77	86	90	91	87	79	1080	62	71	77	92	106	98	95	91
650-5,5	59	75	84	90	93	90	85	78	1090	65	77	80	95	109	101	98	94
650-7,5	52	68	81	91	96	93	85	78									

**Dimensiones mm**

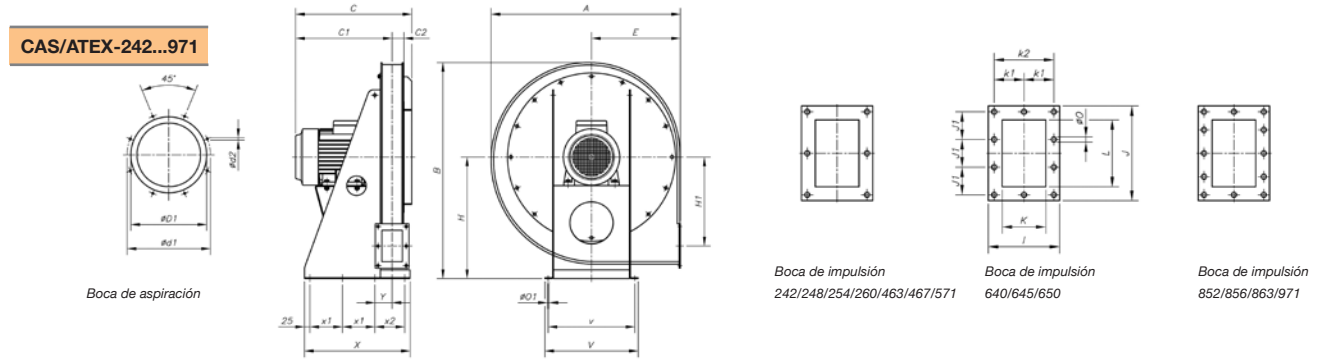

Modelo	A	B	C	C1	C2	øD1	ød1	ød2	E	H	H1	I	J	J1	K	k1	k2	L	øO	øO1	V	v	X	x1	x2	Y
CAS/ATEX-242-2T-0'33	576	662	282	219	33	100	130	M8	270	375	270	120	155	65	60	-	95	95	11	12	305	275	260	75	-	61
CAS/ATEX-242-2T-0'5	576	662	310	247	33	100	130	M8	270	375	270	120	155	65	60	-	95	95	11	12	305	275	260	75	-	61
CAS/ATEX-248-2T-0'75	639	728	315	249	36	112	140	M8	300	410	297	126	165	70	66	-	101	105	11	12	320	290	300	90	-	64
CAS/ATEX-248-2T-1'1'5	639	728	340	274	36	112	140	M8	300	410	297	126	165	70	66	-	101	105	11	12	320	290	300	90	-	64
CAS/ATEX-254-2T-1'5	699	788	365	294,5	40,5	125	155	M8	330	440	322	135	175	75	75	-	110	115	11	14	340	310	330	100	-	68,5
CAS/ATEX-254-2T-2	699	788	413	342,5	40,5	125	155	M8	330	440	322	135	175	75	75	-	110	115	11	14	340	310	330	100	-	68,5
CAS/ATEX-254-2T-3	699	788	443	372,5	40,5	125	155	M8	330	440	322	135	175	75	75	-	110	115	11	14	340	310	330	100	-	68,5
CAS/ATEX-260-2T-2/3	782	875	419	343,5	47,5	150	175	M8	370	485	362	145	185	80	85	-	120	125	11	14	380	350	370	115	-	73,5
CAS/ATEX-463-2T-5'5	782	875	459	383,5	45,5	200	240	M8	370	485	362	145	185	80	85	-	120	125	11	14	380	350	370	115	-	73,5
CAS/ATEX-463-2T-7'5	782	875	517	441,5	45,5	200	240	M8	370	485	362	145	185	80	85	-	120	125	11	14	380	350	370	115	-	73,5
CAS/ATEX-467-2T-7'5/10	833	945	530	442	48	224	258	M8	390	530	395	150	190	82,5	90	-	125	130	11	14	405	375	300	125	-	76
CAS/ATEX-571-2T-10	873	995	536	445,5	50,5	250	275	M8	410	560	410	155	205	90	95	-	130	145	11	14	430	400	350	150	-	79,5
CAS/ATEX-571-2T-15	873	995	671	580,5	50,5	250	275	M8	410	560	410	155	205	90	95	-	130	145	11	14	430	400	410	180	-	79,5
CAS/ATEX-640-2T-2	639	728	446	350,5	65,5	250	275	M8	300	410	250	185	260	78	125	80	-	200	11	14	340	310	350	100	-	93,5
CAS/ATEX-645-2T-3	699	788	461	358	73	250	275	M8	330	440	267,5	200	284	86	140	87,5	-	224	11	14	380	350	380	115	-	101
CAS/ATEX-645-2T-4	699	788	491	388	73	250	275	M8	330	440	267,5	200	284	86	140	87,5	-	224	11	14	380	350	380	115	-	101
CAS/ATEX-650-2T-5'5	782	875	534	421	83	250	275	M8	370	485	300	220	310	95	160	97,5	-	250	11	14	405	375	490	125	190	111
CAS/ATEX-650-2T-7'5	782	875	572	459	83	250	275	M8	370	485	300	220	310	95	160	97,5	-	250	11	14	405	375	490	125	190	111
CAS/ATEX-852-2T-7'5/10	833	945	603	470	94,5	380	310	M8	390	530	320	240	340	78	180	107,5	-	280	11	14	430	400	540	150	190	122
CAS/ATEX-856-2T-15	833	945	708	575	93	355	395	M8	390	530	320	240	340	78	180	107,5	-	280	11	14	430	400	600	180	190	122
CAS/ATEX-863-2T-15/20	873	995	728	585	103	355	410	M8	410	560	325	260	375	87,5	200	117,5	-	315	11	14	430	400	620	180	210	132
CAS/ATEX-971-2T-25	1012	1170	759	598	116	400	450	M10	460	670	420	294	425	100	224	132	-	355	11	14	550	510	715	150	215	145
CAS/ATEX-971-2T-30	1012	1170	881	720	116	400	450	M10	460	670	420	294	425	100	224	132	-	355	11	14	550	510	715	150	215	145
CAS/ATEX-971-2T-40	1012	1170	948	787	116	400	450	M10	460	670	420	294	425	100	224	132	-	355	11	14	550	510	715	150	215	145

Las medidas corresponden a la versión Ex "e"

Dimensiones mm

CAS/ATEX-1250...2080

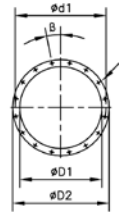

Boca de aspiración

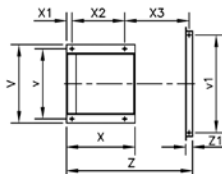
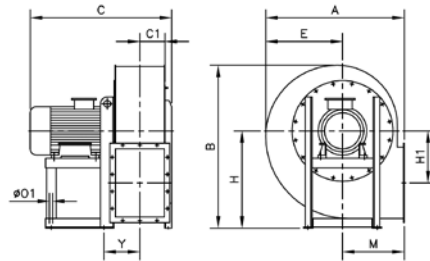

Boca de impulsión  
CAS-1250-2T-15/A  
CAS-1456-2T-25/A  
CAS-1663-2T-50/A

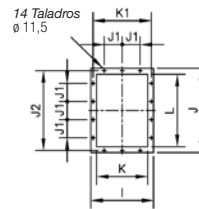

Boca de impulsión  
CAS-1671-2T-60/A  
CAS-2071-2T-100/A  
CAS-2080-2T-125/A

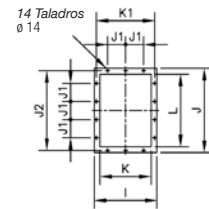

Modelo	A	B	C	C1	$\phi D1$	$\phi D2$	$\phi d1$	x $\phi$	$\beta$	E	H	H1	I	J	J1	J2	K	K1	L	M	$\phi O1$	V	v	v1	X	X1	X2	X3	Y	Z	Z1
CAS-1250-2T-15/A	865	1055	885	160	361	441	405	8x11,5	22°30'	510	630	365	360	480	125	448	280	332	400	355	14	440	400	-	425	30	340	-	202	-	-
CAS-1456-2T-25/A	970	1185	900	163	456	535	497	12x12	15°	555	710	410	395	530	125	497	315	366	450	400	14	440	400	-	425	30	340	-	219	-	-
CAS-1663-2T-50/A	1010	1280	1035	183	568	668	629	16x11,5	11°15'	560	800	380	435	580	125	551	355	405	500	450	16	570	510	-	500	40	385	-	263	-	-
CAS-1671-2T-60/A	1130	1340	1160	206	638	738	698	16x13	11°15'	630	800	430	500	660	160	629	400	464	560	500	19	626	565	800	550	40	425	530	292	1025	60
CAS-2071-2T-100/A	1130	1340	1290	206	638	738	698	16x13	11°15'	630	800	430	500	660	160	629	400	464	560	500	21	760	680	800	700	50	550	545	307	1125	60
CAS-2080-2T-125/A	1270	1505	1345	231	718	818	775	16x13	11°15'	710	900	486	550	730	160	698	450	513	630	560	24	760	680	900	700	50	550	595	333	1225	60

CAS/ATEX-680...1090

Boca de aspiración

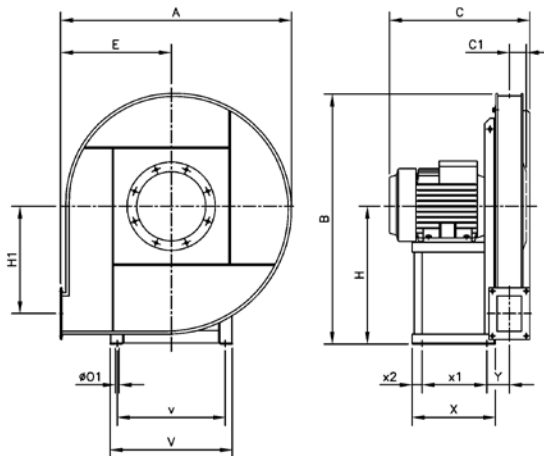
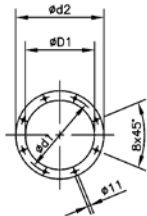

Boca de impulsión  
CAS-680/790

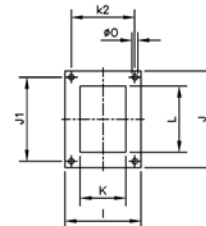

Boca de impulsión  
CAS-980...1090

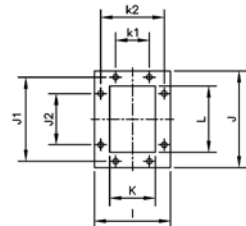

Modelo	A	B	C	C1	$\phi D1$	$\phi d1$	$\phi d2$	E	H	H1	I	J	J1	J2	K	k1	k2	L	$\phi O$	$\phi O1$	V	v	X	x1	x2	Y
CAS-680-2T-12'5	925	995	550	50	165	200	235	450	530	430	131	160	125	-	71	-	100	100	9	12	392	360	320	250	25	87
CAS-790-2T-20	1100	1180	650	58	185	219	255	530	630	520	140	172	140	-	80	-	112	112	9	14	440	400	425	340	30	103
CAS-980-2T-30	1120	1250	725	90	255	292	325	530	710	530	210	270	241	112	140	112	182	200	11,5	14	440	400	425	340	35	145
CAS-990-2T-50	1250	1400	900	100	286	332	366	600	800	600	230	294	265	112	160	112	200	224	11,5	16	570	510	500	385	40	165
CAS-1080-2T-40	1120	1250	850	90	255	392	325	530	710	530	210	270	241	112	140	112	182	200	11,5	16	570	510	500	385	40	155
CAS-1090-2T-60	1250	1400	930	100	286	332	366	600	800	600	230	294	265	112	160	112	200	224	11,5	16	626	565	550	425	40	175

**Curvas Características**

Q= Caudal en m<sup>3</sup>/h, m<sup>3</sup>/s y cfm.

Pe= Presión estática en mmH<sub>2</sub>O, Pa e inwg.

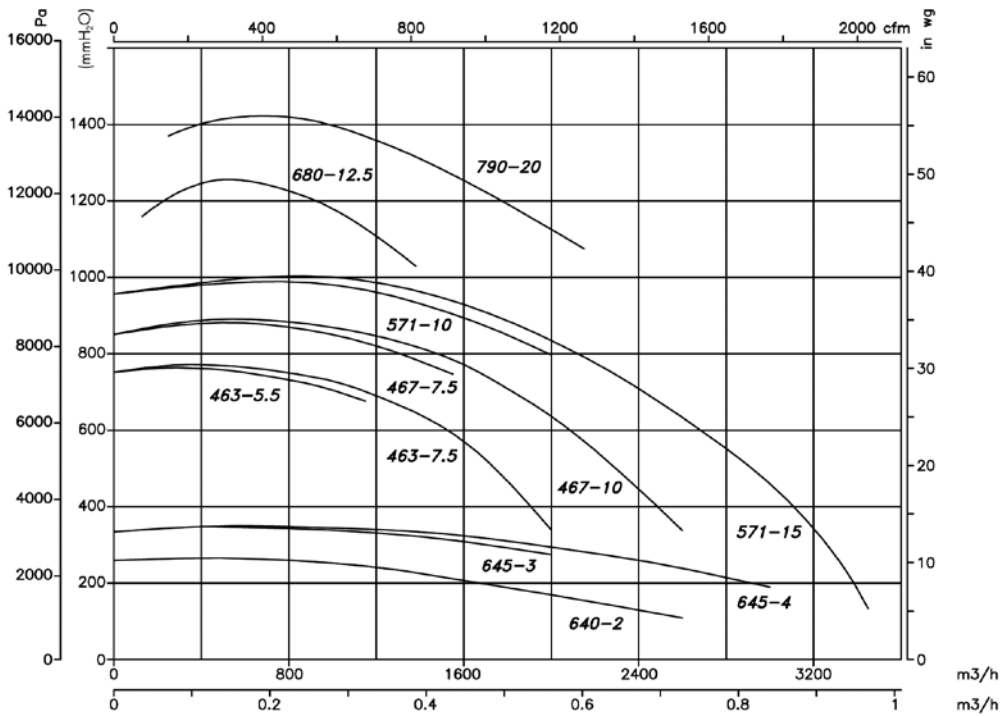
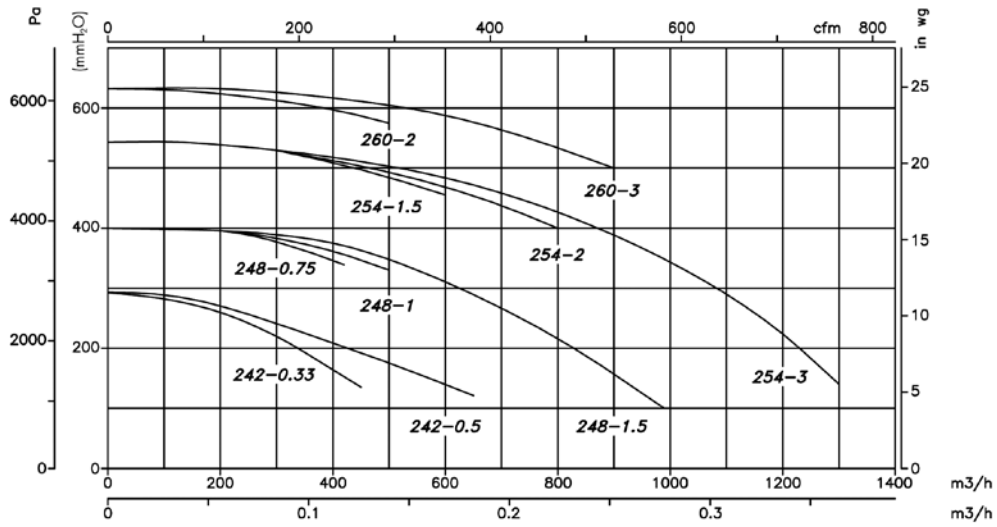

**Accesorios**

Ver apartado accesorios.



INT



AR



VSD3/A-RFT  
VSD1/A-RFM



CUADROS



RPA



B



BIC



ACE/ATEX



CJACUS



REG



S



INT-ATEX

**Curvas Características**

Q= Caudal en m<sup>3</sup>/h, m<sup>3</sup>/s y cfm.

Pe= Presión estática en mmH<sub>2</sub>O, Pa e inwg.

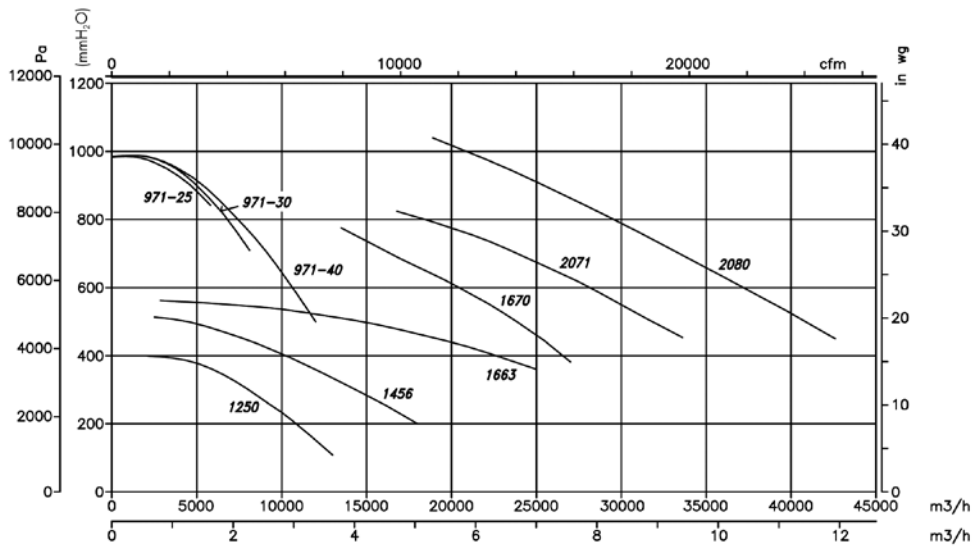
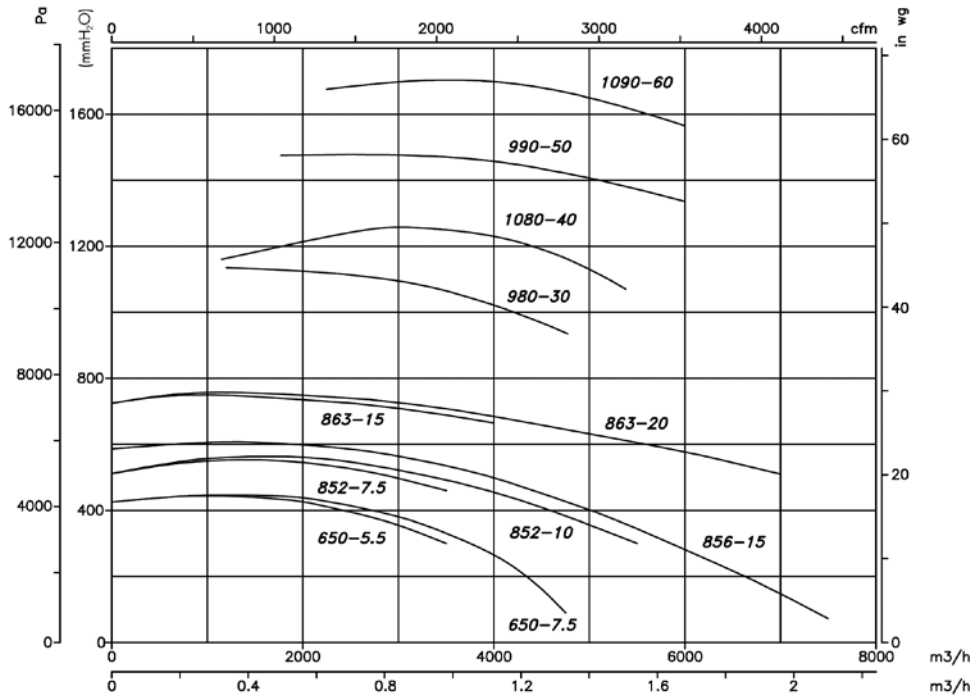

**Orientaciones**

Suministro standard LG 270  
Posiciones LG 180 bajo demanda  
y con medidas de anclaje especiales.



Suministro bajo demanda  
Posiciones RD 180 con medidas  
de anclaje especiales.



# CA/ATEX

## Extractores centrífugos de alta presión y simple aspiración en fundición de aluminio, con certificación ATEX

Extractores centrífugos de alta presión, con envolvente y turbina en fundición de aluminio y Certificación ATEX con motor antiexplosivo CEE ExII2G Ex e, antideflagrante CEE ExII2G Ex d, Ex tc, o Ex tb, para trabajar en atmósferas explosivas.

### Ventilador:

- Envolvente en fundición de aluminio
- Turbina en fundición de aluminio

### Motor:

- Motores clase F, con rodamientos a bolas con certificación ATEX, antiexplosivos Ex e, antideflagrante Ex d, Ex tc, o Ex tb
- Trifásicos 230/400V.-50Hz.(hasta 4 kW) y 400/690V.-50Hz. (potencias superiores a 4 kW)
- Temperatura máxima del aire a transportar: -20°C.+ 80°C.



Ex "e" marcado: CEE II 2G Ex e  
 Ex "d" marcado: CEE II 2G Ex d  
 Ex tc marcado: CEE II 3D Ex tc  
 Ex tb marcado: CEE II 2D Ex tb  
 Organismo notificado: L.O.M.  
 N° de identificación:  
 LOM4ATEX007

### Acabado:

- Anticorrosivo con pintura ATEX, libre de componentes férricos, en resina de poliéster polimerizada a 190 °C, previo desengrase con tratamiento nanotecnológico libre de fosfatos

### Bajo demanda:

- Motores con PTC incorporada
- Bobinados especiales para diferentes tensiones y frecuencias
- Construcción ATEX para diferentes categorías
- Extractores con motor de 2 velocidades



Construcción en aluminio para evitar chispas

## Código de pedido

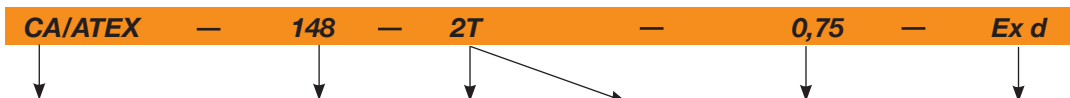

Ventiladores centrífugos de alta presión y simple aspiración con envolvente y turbina en fundición de aluminio con certificación ATEX

Tamaño turbina

Número de polos motor  
 2=2900 r/min. 50 Hz

T=Trifásico

Potencia motor (c.v.)

Ex-e marcado:  
 CEE II 2G Ex e IIB T3  
 Ex "d" marcado:  
 CEE II 2G Ex d IIB T5  
 Ex tc marcado:  
 CEE II 3D Ex tc  
 Ex tb marcado:  
 CEE II 2D Ex tb

### Markado:

CEE II 2G c  
 CEE II 2D c  
 CEE II 3D c

## Características técnicas

Modelo	Velocidad (r/min)	Intensidad máxima admisible (A)			Potencia instalada (kW)	Caudal máximo (m³/h)	Nivel presión sonora dB(A)	Peso aprox. (Kg)
		230V	400V	690V				
CA/ATEX-234-2T	2770	2,08	1,20	0,37	220	72	10,2	
CA/ATEX-142-2T-0,33	2740	1,73	1,00	0,25	275	73	22,5	
CA/ATEX-142-2T-0,5	2770	2,08	1,20	0,37	350	73	22,5	
CA/ATEX-148-2T-0,75	2710	2,94	1,70	0,55	400	74	28,0	
CA/ATEX-148-2T-1	2820	3,46	2,00	0,75	490	75	30,0	
CA/ATEX-148-2T-1,5	2850	4,50	2,60	1,10	610	76	32,0	
CA/ATEX-154-2T-1,5	2850	4,50	2,60	1,10	600	78	46,0	
CA/ATEX-154-2T-2	2800	6,24	3,60	1,50	800	79	48,5	
CA/ATEX-154-2T-3	2860	8,66	5,00	2,20	1280	80	50,5	
CA/ATEX-160-2T-2	2800	6,24	3,60	1,50	500	83	57,0	
CA/ATEX-160-2T-3	2860	8,66	5,00	2,20	900	84	58,0	
CA/ATEX-166-2T-3	2860	8,66	5,00	2,20	500	84	67,0	
CA/ATEX-166-2T-4	2845	12,12	7,00	3,00	950	85	73,0	
CA/ATEX-166-2T-5,5	2910	15,42	8,90	4,00	1600	86	76,0	
CA/ATEX-172-2T-5,5	2910	15,42	8,90	4,00	1100	87	90,0	
CA/ATEX-172-2T-7,5	2880		10,50	6,09	5,50	1710	88	112,0
CA/ATEX-172-2T-10	2880		15,70	9,06	7,50	2300	89	124,0



**Características acústicas**

Los valores indicados, se determinan mediante medidas de nivel de presión y potencia sonora en dB(A) obtenidas en campo libre a una distancia equivalente a dos veces la envergadura del ventilador más el diámetro de la turbina, con un mínimo de 1,5 mts.

Espectro de potencia sonora Lw(A) en dB(A) por banda de frecuencia en Hz

Modelo	63	125	250	500	1000	2000	4000	8000	Modelo	63	125	250	500	1000	2000	4000	8000
234	38	51	65	72	80	79	73	64	160-2	54	67	81	88	96	94	88	80
142	39	52	66	73	81	80	74	65	160-3	55	68	82	89	97	95	89	81
148-0,75	43	56	70	77	85	83	77	69	166-3	55	68	82	89	97	95	89	81
148-1	44	57	71	78	86	84	78	70	166-4	56	69	83	90	98	96	90	82
148-1,5	45	58	72	79	87	85	79	71	166-5,5	57	70	84	91	99	97	91	83
154-1,5	47	60	74	81	89	87	81	73	172-5,5	59	72	86	93	101	100	94	85
154-2	48	61	75	82	90	88	82	74	172-7,5	60	73	87	94	102	101	95	86
154-3	49	62	76	83	91	89	83	75	172-10	61	74	88	95	103	102	96	87

**Dimensiones mm**

**CA/ATEX-234**

Modelo	A	A1	B	C	C1	C2	øD	ød	ød1	ød2	E	H	H1	I	J	øK	k	øO	øO1	V	v	x1	Y
CA-234-2T-0,33	376	381	415	272	242,5	29,5	98	130	115	M4	175	225	187	98	63	40	72	9	9	180	120	40	94
CA-234-2M-0,33	376	381	415	272	242,5	29,5	98	130	115	M4	175	225	187	98	63	40	72	9	9	180	120	40	94

**CA/ATEX-142...172**

Modelo	A	A1	B	C	C1	C2	øD	ød	ød1	ød2	E	H	H1	I	J	øK	øk	øO	øO1	V	v	x1	Y
CA-142-2T-0'33	494	488	540	270	221,52	48,5	90	160	130	M8	240	301	235	120	60	90	11	12	300	270	130	51	
CA-142-2T-0'5	494	488	540	290	241,5	48,5	90	160	130	M8	240	301	235	120	60	90	11	12	300	270	130	51	
CA-148-2T-0'75	563	557,5	639	308,5	251,5	57	100	170	140	M8	270	360	269,5	150	73	110	11	12	330	290	140	60	
CA-148-2T-1	563	557,5	639	324,5	267,5	57	100	170	140	M8	270	360	269,5	150	73	110	11	12	330	290	140	60	
CA-148-2T-1'5	563	557,5	639	324,5	267,5	57	100	170	140	M8	270	360	269,5	150	73	110	11	12	330	290	140	60	
CA-154-2T-1'5	630	625	708	348	268,5	79,5	115	183	155	M10	300	395	308	160	80	120	13	12	356	320	210	62	
CA-154-2T-2	630	625	708	371	291,5	79,5	115	183	155	M10	300	395	308	160	80	120	13	12	356	320	210	62	
CA-154-2T-3	630	625	708	396	316,5	79,5	115	183	155	M10	300	395	308	160	80	120	13	12	356	320	210	62	
CA-160-2T-2	708	699	785	381	291	90	130	230	192	M10	336	440	338	160	85	120	13	12	373	322	220	62	
CA-160-2T-3	708	699	785	406	316	90	130	230	192	M10	336	440	338	160	85	120	13	12	373	322	220	62	
CA-166-2T-3	759	752	866	399	319,5	79,5	140	230	200	M10	364	490	372	160	85	120	13	12	450	400	245	70	
CA-166-2T-4	759	752	866	423	343,5	79,5	140	230	200	M10	364	490	372	160	85	120	13	12	450	400	245	70	
CA-166-2T-5'5	759	752	866	445	365,5	79,5	140	230	200	M10	364	490	372	160	85	120	13	12	450	400	265	70	
CA-172-2T-5'5	818	813	923	451	371	80	148	230	200	M10	390	516	404	175	90	140	13	12	450	400	260	78	
CA-172-2T-7'5	818	813	923	492	412	80	148	230	200	M10	390	516	404	175	90	140	13	12	450	400	300	78	
CA-172-2T-10	818	813	923	492	412	80	148	230	200	M10	390	516	404	175	90	140	13	12	450	400	300	78	

Las medidas corresponden a la versión Ex "e"

**Curvas Características**

Q= Caudal en m³/h, m³/s y cfm.

Pe= Presión estática en mmH2O, Pa e inwg.

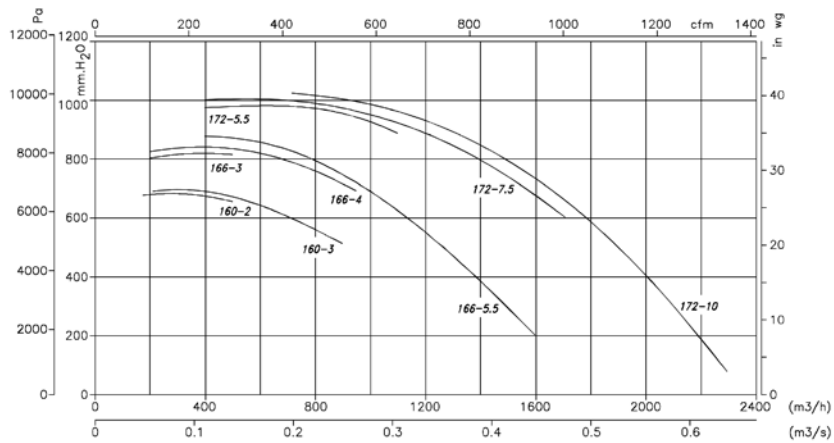
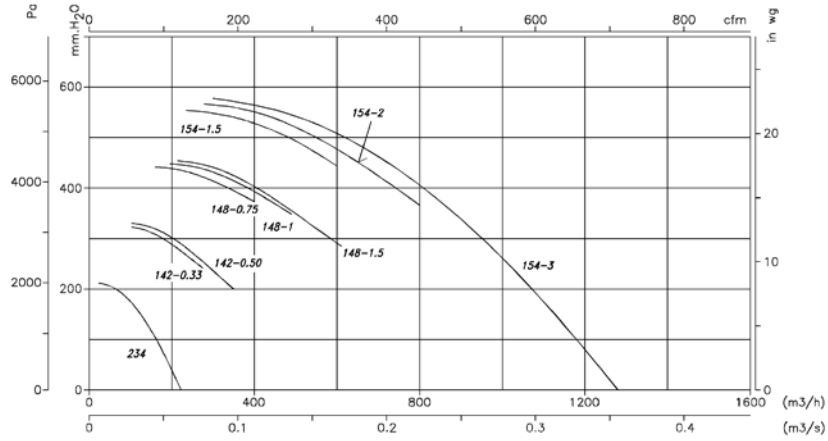

**Orientaciones**

Suministro standard LG 270

Posiciones LG 180 bajo demanda y con medidas de anclaje especiales.



**Accesorios**

Ver apartado accesorios.



# HT/ATEX

## Extractores helicoidales de tejado, con Certificación ATEX y posible marcado Ex e, Ex d, Ex tc y Ex tb



Extractores de tejado con base plana y Certificación ATEX con motor antiexplosivo CEE ExII2G Ex e, antideflagrante CEE ExII2G Ex d, Ex tc, o Ex tb para trabajar en atmósferas explosivas de gas o polvo.

### Ventilador:

- Base soporte en chapa de acero con banda de aluminio en la zona de la hélice según norma EN-14986:2007
- Hélice en fundición de aluminio
- Prensaestopas antichispas incluido
- Rejilla de protección contra contactos según norma UNE-EN ISO 12499:2010
- Sombbrero deflector antilluvia en chapa de aluminio, con protección anticorrosiva, excepto modelos 80,90,100 en poliéster
- Dirección aire motor-hélice

### Motor:

- Motores clase F, con rodamientos a bolas con certificación ATEX, antiexplosivos Ex e, antideflagrante Ex d, Ex tc, o Ex tb
- Trifásicos 230/400V.-50Hz.(hasta 4 kW) y 400/690V.-50Hz.(potencias superiores a 4 kW)
- Temperatura de trabajo: -20°C.+ 40°C.



Ex "e" marcado: CEE II 2G Ex e  
 Ex "d" marcado: CEE II 2G Ex d  
 Ex tc marcado: CEE II 3D Ex tc  
 Ex tb marcado: CEE II 2D Ex tb  
 Organismo notificado: L.O.M.  
 N° de identificación:  
 LOM3ATEX0157

### Acabado:

- Anticorrosivo con pintura ATEX, libre de componentes férricos, en resina de poliéster polimerizada a 190 °C, previo desengrase con tratamiento nanotecnológico libre de fosfatos

### Bajo demanda:

- Motores con PTC incorporada
- Bobinados especiales para diferentes tensiones y frecuencias
- Construcción ATEX para diferentes categorías
- Extractores con motor de 2 velocidades
- Motores monofásicos antideflagrantes Ex d

## Código de pedido

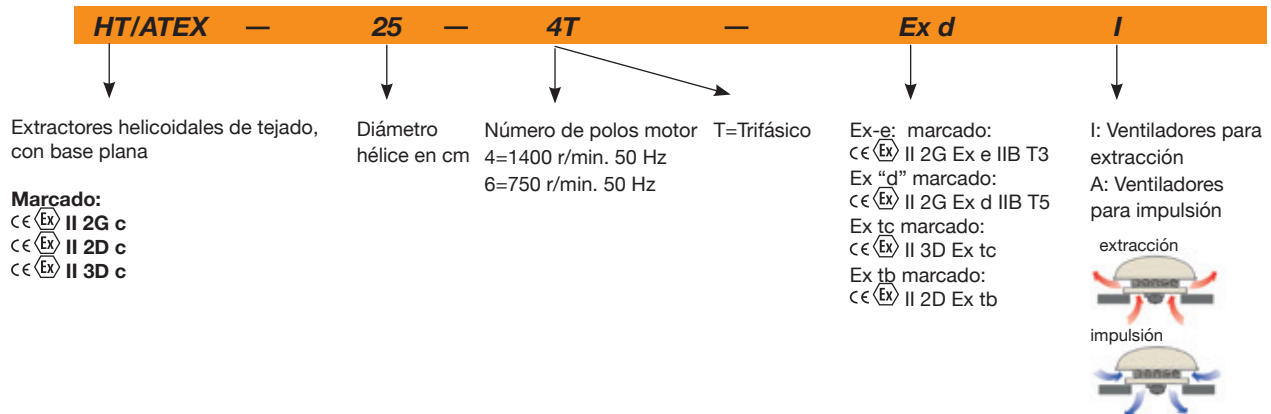

## Características técnicas

Modelo	Velocidad (r/min)	Intensidad máxima admisible (A)			Potencia instalada (kW)	Caudal máximo (m³/h)	Nivel presión sonora dB(A)		Peso aprox. (Kg)
		230V	400V	690V			Aspiración	Descarga	
HT/ATEX-25-4T	1320	0,65	0,38		0,09	1080	41	40	12,5
HT/ATEX-31-4T	1320	0,65	0,38		0,09	1800	47	46	13,3
HT/ATEX-35-4T	1320	0,65	0,38		0,09	2600	48	47	17,5
HT/ATEX-40-4T	1370	2,08	1,20		0,25	4600	51	50	21,0
HT/ATEX-45-4T	1370	2,60	1,50		0,37	6500	55	53	29,0
HT/ATEX-50-4T	1410	2,94	1,70		0,55	8500	59	57	36,0
HT/ATEX-56-4T	1410	3,81	2,20		0,75	9800	61	57	35,0
HT/ATEX-56-6T	910	2,42	1,40		0,25	6600	48	46	46,0
HT/ATEX-63-4T	1410	5,20	3,00		1,10	14000	63	59	65,8
HT/ATEX-63-6T	935	2,77	1,60		0,37	9200	52	49	61,8
HT/ATEX-71-4T	1400	6,93	4,00		1,50	18000	69	67	64,0
HT/ATEX-71-6T	930	3,46	2,00		0,55	12200	58	56	64,9
HT/ATEX-80-4T	1410	9,01	5,20		2,20	26200	73	70	87,8

### Características técnicas

Modelo	Velocidad (r/min)	Intensidad máxima admisible (A)			Potencia instalada (kW)	Caudal máximo (m³/h)	Nivel presión sonora dB(A)		Peso aprox. (Kg)
		230V	400V	690V			Aspiración	Descarga	
HT/ATEX-80-6T	910	5,89	3,40		1,10	18000	64	61	81,8
HT/ATEX-90-4T	1440	12,30	7,10		3,00	31500	77	74	94,0
HT/ATEX-90-6T	940	7,62	4,40		1,50	21200	68	65	91,0
HT/ATEX-100-4T-7,5	1440		12,00	6,93	5,50	37000	80	77	114,0
HT/ATEX-100-4T-10	1448		16,30	9,41	7,50	44000	84	81	125,0
HT/ATEX-100-6T-2	940	7,62	4,40		1,50	25000	71	68	102,0
HT/ATEX-100-6T-3	940	9,35	5,40		2,20	28200	75	72	106,0

### Características acústicas

Los valores indicados, se determinan mediante medidas de nivel de presión y potencia sonora en dB (A) obtenidas en campo libre a una distancia de 6 mts.

Espectro de potencia sonora Lw(A) en dB(A) banda de frecuencia en [Hz]

Valores tomados a la aspiración con 2/3 caudal máximo (2/3Qmax).

Modelo	63	125	250	500	1000	2000	4000	8000
25	27	37	54	54	62	58	51	42
31	33	43	60	60	68	64	57	48
35	34	44	61	61	69	65	58	49
40	28	45	57	65	70	70	66	59
45	32	49	61	69	74	74	70	63
50	36	53	65	73	78	78	74	67
56-4	38	55	67	75	80	80	76	69
56-6	25	42	54	62	67	67	63	56
63-4	40	57	69	77	82	82	78	71
63-6	29	46	58	66	71	71	67	60
71-4	46	63	75	83	88	88	84	77
71-6	35	52	64	72	77	77	73	66
80-4	57	78	85	90	93	89	82	71
80-6	48	69	76	81	84	80	73	62
90-4	61	82	89	94	97	93	86	75
90-6	52	73	80	85	88	84	77	66
100-4-7.5	64	85	92	97	100	96	89	78
100-4-10	68	89	96	101	104	100	93	82
100-6-2	55	76	83	88	91	87	80	69
100-6-3	59	80	87	92	95	91	84	73
100-8-1.5	48	69	76	81	84	80	73	62
100-8-2	50	71	78	83	86	82	75	64

Valores tomados a la descarga con 2/3 caudal máximo (2/3Qmax).

Modelo	63	125	250	500	1000	2000	4000	8000
25	26	36	53	53	61	57	50	41
31	32	42	59	59	67	63	56	47
35	33	43	60	60	68	64	57	48
40	27	44	56	64	69	69	65	58
45	30	47	59	67	72	72	68	61
50	34	51	63	71	76	76	72	65
56-4	34	51	63	71	76	76	72	65
56-6	23	40	52	60	65	65	61	54
63-4	36	53	65	73	78	78	74	67
63-6	26	43	55	63	68	68	64	57
71-4	44	61	73	81	86	86	82	75
71-6	33	50	62	70	75	75	71	64
80-4	54	75	82	87	90	86	79	68
80-6	45	66	73	78	81	77	70	59
90-4	58	79	86	91	94	90	83	72
90-6	49	70	77	82	85	81	74	63
100-4-7.5	61	82	89	94	97	93	86	75
100-4-10	65	86	93	98	101	97	90	79
100-6-2	52	73	80	85	88	84	77	66
100-6-3	56	77	84	89	92	88	81	70
100-8-1.5	45	66	73	78	81	77	70	59
100-8-2	47	68	75	80	83	79	72	61

### Dimensiones mm

Modelo	A	B	C	D	E	ØF	G	H	ØI	ØJ
HT-25	400	176	44	40	140	620	450	360	12	346
HT-31	423	176	67	40	140	620	500	410	12	416
HT-35	472	228	64	40	140	770	560	450	12	486
HT-40	478	228	82	40	128	770	630	530	12	536
HT-45-4T	550	266	88	50	146	960	710	590	12	596
HT-50-4T	575	296	83	50	146	1090	800	680	12	676
HT-56-4T	607	296	117	40	154	1090	900	750	14	758
HT-56-6	589	296	117	40	136	1090	900	750	14	758
HT-63-4	714	357	136	40	182	1285	1000	850	14	735
HT-63-6	667	357	136	40	135	1285	1000	850	14	735
HT-71-4T	740	357	166	40	178	1285	1000	850	14	815
HT-71-6	689	357	166	40	178	1285	1000	850	14	815
HT-80-4	840	357	244	50	189	1285	1150	1000	14	905
HT-80-6	804	357	244	50	153	1285	1150	1000	14	905
HT-90-4	892	440	213	50	189	1580	1150	1000	14	1020
HT-90-6	896	440	213	50	193	1580	1150	1000	14	1020
HT-100-4T	997	440	284	50	223	1580	1250	1100	14	1120
HT-100-6T-2	940	440	284	50	166	1580	1250	1100	14	1120
HT-100-6T-3	957	440	284	50	183	1580	1250	1100	14	1120

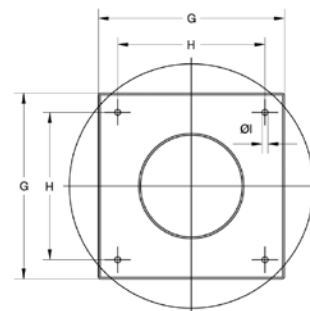
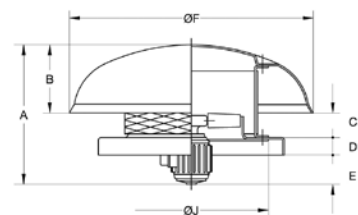

**Curvas características**

Q= Caudal en m<sup>3</sup>/h, m<sup>3</sup>/s y cfm.

Pe= Presión estática en mmH<sub>2</sub>O, Pa e in wg.

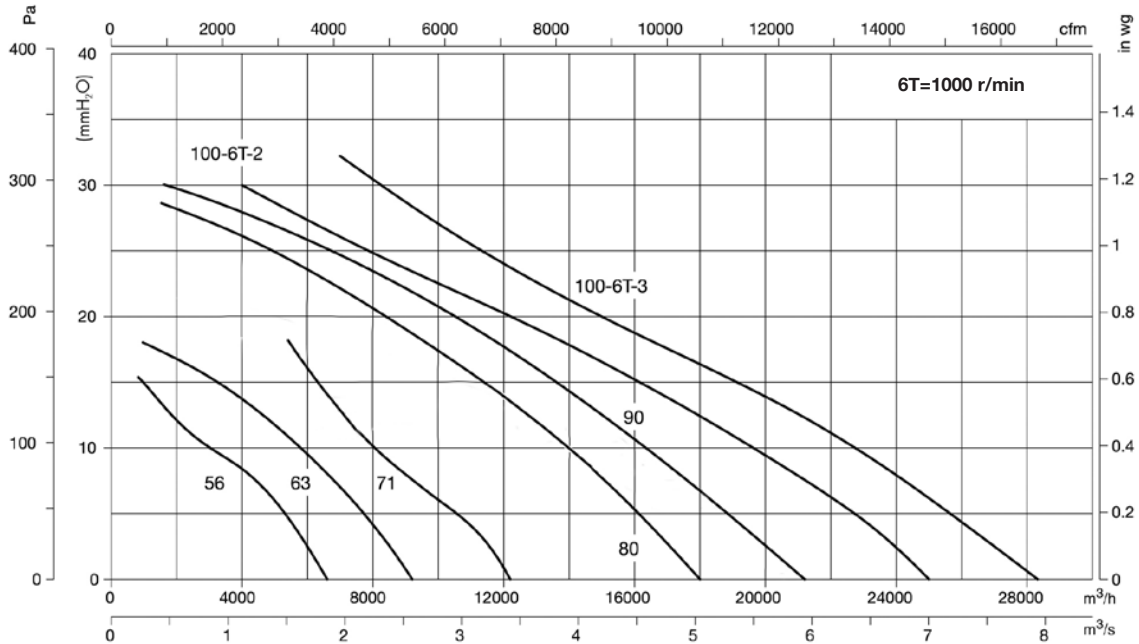
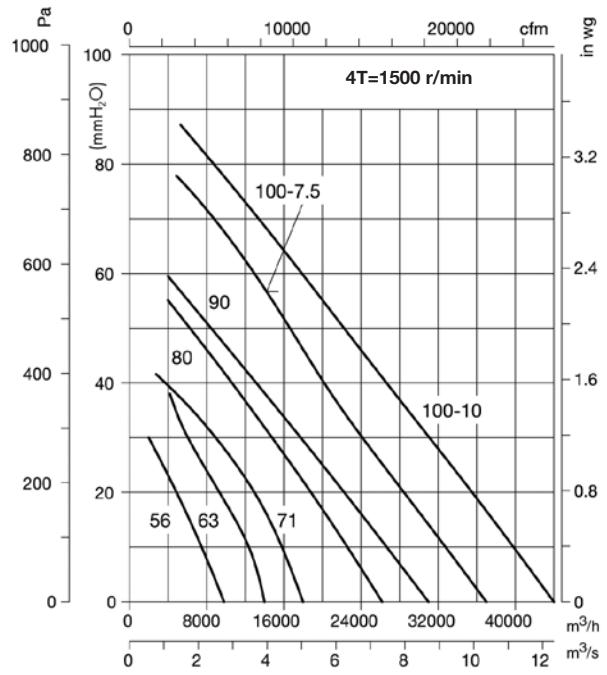
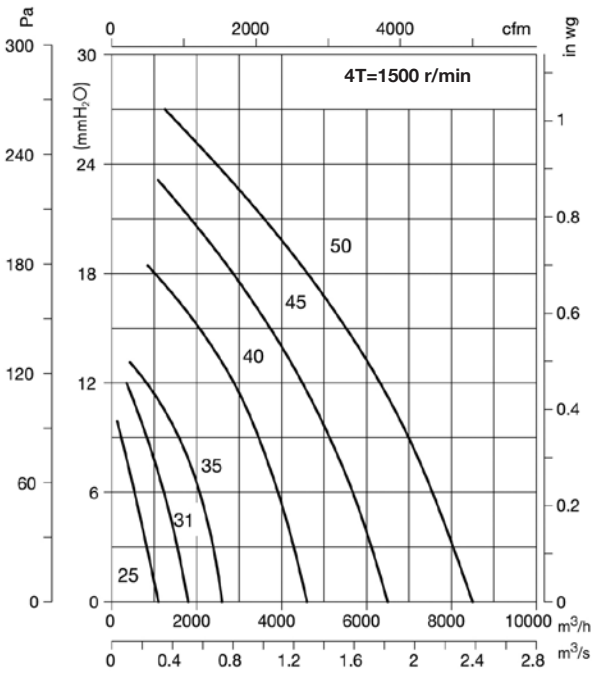

**Accesorios**

Ver apartado accesorios.



INT



AR



VSD3/A-RFT  
VSD1/A-RFM



CUADROS



B



MS



PA



OP



S



INT-ATEX

# RFHD



## Extractores centrífugos de tejado con salida horizontal y certificación ATEX Ex d

Extractores centrífugos de tejado, con salida de aire horizontal y sombrerete en aluminio. Certificación ATEX y motor antideflagrante CEE ExII2G Ex d, para trabajar en atmósferas explosivas.



Ex "d" marcado:  $\text{C} \llcorner \text{Ex} \text{ II 2G Ex d}$   
 Organismo notificado: L.O.M  
 N° de identificación: LOM03ATEX0147

### Ventilador:

- Base soporte en chapa de acero galvanizado, con boca de aspiración en latón según norma EN-14986:2007
- Turbina con álabes a reacción, en chapa de acero galvanizado
- Rejilla de protección antipájaros
- Sombrero deflector antilluvia en aluminio

### Motor:

- Motores clase F, con rodamientos a bolas con certificación ATEX antideflagrante Ex d II B T4 Gb
- Trifásicos 230/400 V-50 Hz (hasta 4kW) y 400/690 V-50 Hz (potencias superiores a 4kW)

- Temperatura máxima del aire a transportar: -20 °C+ 80 °C

### Acabado:

- Anticorrosivo en chapa de acero galvanizado y aluminio

### Bajo demanda:

- Motores con PTC incorporada.
- Bobinados especiales para diferentes tensiones y frecuencias.
- Construcción ATEX para diferentes categorías.
- Motores monofásicos antideflagrantes Ex d

## Código de pedido

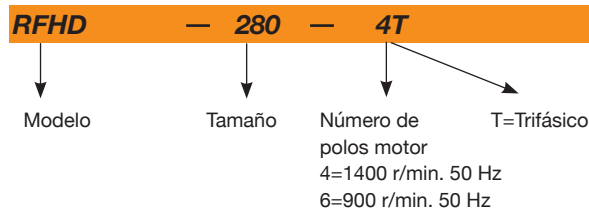

## Características técnicas

Modelo	Velocidad (r/min)	Intensidad máxima admisible (A)			Potencia instalada (kW)	Caudal máximo (m³/h)	Nivel presión sonora dB(A)		Peso aprox. (Kg)
		230V	400V	690V			Aspiración	Descarga	
RFHD-280-4T	1370	2,08	1,20		0,25	1450	37	43	25
RFHD-315-4T	1370	2,08	1,20		0,25	2100	41	47	25
RFHD-315-6T	910	2,42	1,40		0,25	1400	30	36	25
RFHD-355-4T	1370	2,08	1,20		0,25	3100	45	50	32
RFHD-355-6T	910	2,42	1,40		0,25	2000	33	40	33
RFHD-400-4T	1410	2,94	1,70		0,55	4950	48	54	35
RFHD-400-6T	935	2,77	1,60		0,37	3200	37	43	35
RFHD-450-4T	1410	3,81	2,20		0,75	7000	55	61	52
RFHD-450-6T	935	2,77	1,60		0,37	4500	44	50	51
RFHD-500-4T	1400	6,93	4,00		1,50	10200	59	64	60
RFHD-500-6T	935	2,77	1,60		0,37	6900	47	54	53
RFHD-630-6T	910	5,89	3,40		1,10	12000	51	57	95
RFHD-710-6T	940	9,35	5,40		2,20	17300	54	61	118
RFHD-800-6T	950		14,00	8,10	5,50	24700	58	64	160

(1) Los valores de los niveles sonoros, son presiones en dB(A), medidos a 6 metros, y a 2/3 del caudal máximo (2/3 Qmáx.)

**Características acústicas**

Los valores indicados, se determinan mediante medidas de nivel de presión y potencia sonora en dB(A) obtenidas en campo libre a una distancia de 6 mts.

**Espectro de potencia sonora Lw(A) en dB(A) por banda de frecuencia en Hz.**

Valores tomados a la aspiración con 2/3 caudal máximo (2/3Qmax).

Modelo	63	125	250	500	1000	2000	4000	8000
280-4	35	41	52	55	56	52	50	44
315-4	42	51	56	56	60	59	52	46
315-6	31	40	45	45	49	48	41	35
355-4	46	55	60	60	64	63	56	50
355-6	34	43	48	48	52	51	44	38
400-4	50	56	62	62	65	68	59	53
400-6	39	45	51	51	54	57	48	42
450-4	57	63	69	69	72	75	66	60
450-6	46	52	58	58	61	64	55	49
500-4	62	69	74	74	78	77	70	65
500-6	50	57	62	62	66	65	58	53
630-6	54	60	65	66	70	69	62	55
710-6	57	63	68	69	73	72	65	58
800-6	61	67	72	73	77	76	69	62

Valores tomados a la descarga con 2/3 caudal máximo (2/3Qmax).

Modelo	63	125	250	500	1000	2000	4000	8000
280-4	39	44	58	60	61	61	56	51
315-4	41	50	60	64	67	64	57	51
315-6	30	39	49	53	56	53	46	40
355-4	44	53	63	67	70	67	60	54
355-6	34	43	53	57	60	57	50	44
400-4	49	61	69	71	72	72	64	56
400-6	38	50	58	60	61	61	53	45
450-4	56	68	76	78	79	79	71	63
450-6	45	57	65	67	68	68	60	52
500-4	60	72	80	82	83	80	73	65
500-6	50	62	70	72	73	70	63	55
630-6	50	64	72	76	75	72	66	60
710-6	54	68	76	80	79	76	70	64
800-6	57	71	79	83	72	79	73	67

Para obtener los espectros de potencia sonora Lwa en dB(A) en la aspiración a caudal máximo (Qmax), sumar al nivel de presión sonora LpA dado en las curvas características, los valores de la tabla siguiente:

Banda de frecuencia en Hz								
63	125	250	500	1000	2000	4000	8000	
2	9	15	15	18	18	11	5	

**Dimensiones mm**

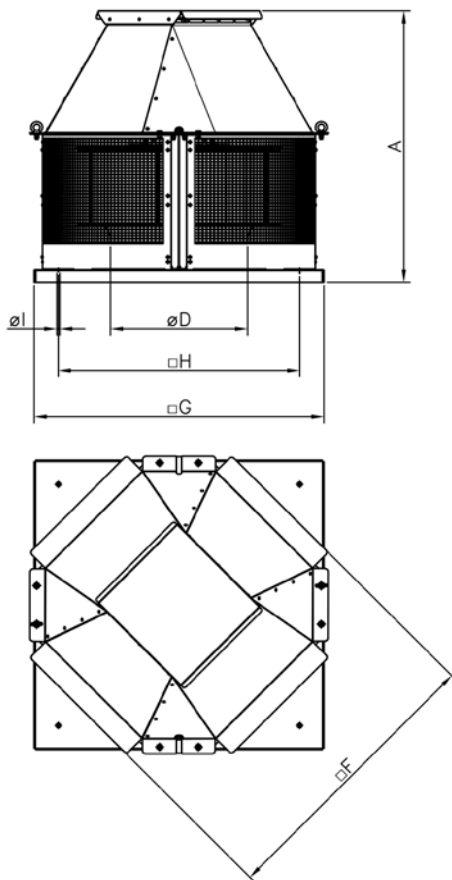

Modelo	A	ØD*	F	G	H	ØI
RFHD-280	515	250	460	450	360	12
RFHD-315	540	250	460	450	360	12
RFHD-355	610	355	565	560	450	12
RFHD-400	665	355	565	560	450	12
RFHD-450	720	500	735	710	590	12
RFHD-500	755	500	735	710	590	12
RFHD-630	845	630	890	900	750	14
RFHD-710	995	710	1110	1100	900	14
RFHD-800	1065	710	1110	1100	900	14

(\*) Diámetro nominal tubería recomendada

**Curvas características**

Q= Caudal en m<sup>3</sup>/h, m<sup>3</sup>/s y cfm.

Pe= Presión estática en mmH<sub>2</sub>O, Pa e inwg.

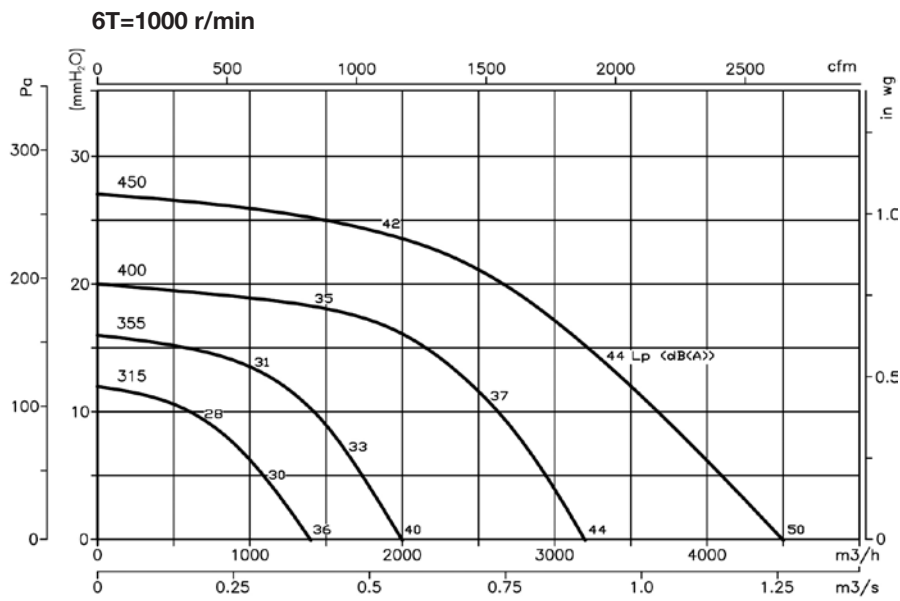
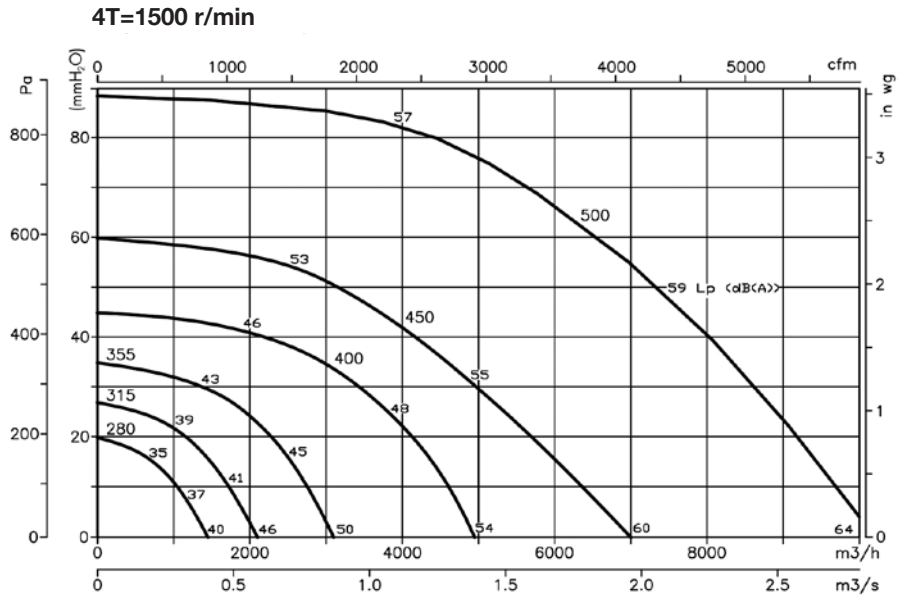



**Curvas características**

Q= Caudal en m³/h, m³/s y cfm.

Pe= Presión estática en mmH²O, Pa e inwg.

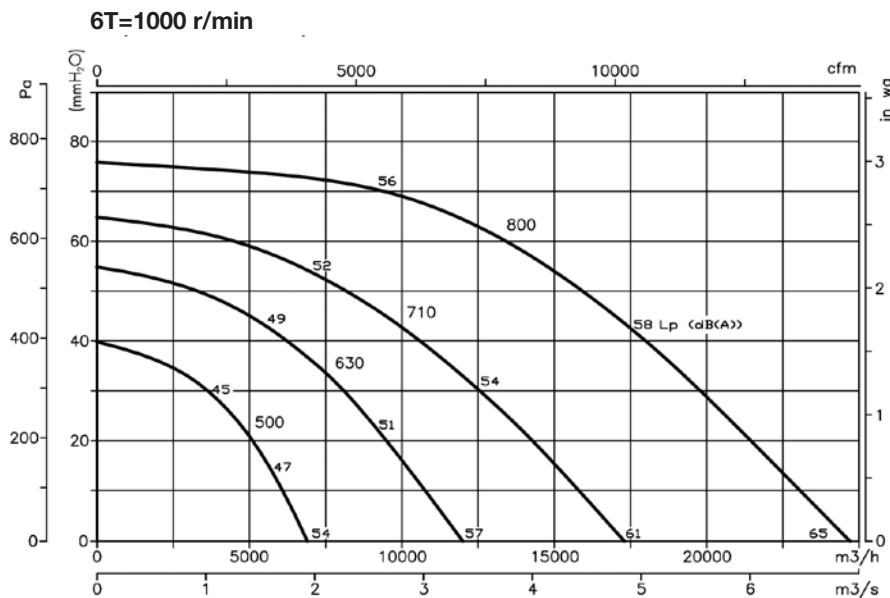

**Accesorios**

Ver apartado accesorios



**Accesorios de montaje para RFHD**

Ventilador RFHD	Base Soporte	Marco Soporte	Placa Adaptación
280/315	BS-443	MS-443	PA-440/250
355/400	BS-553	MS-553	PA-550
450/500	BS-701	MS-701	PA-700/500
630	BS-891	MS-891	PA-890/630
710/800	BS-1086	MS-1086	PA-1085

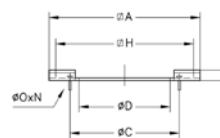
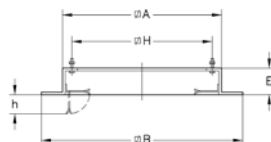
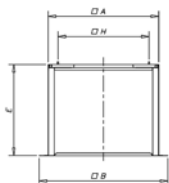

**BS. Base soporte elevada**

	A	B	H	E
BS-443	449	616	360	800
BS-553	554	724	450	800
BS-701	706	876	590	900
BS-891	896	1076	750	900
BS-1086	1092	1272	900	900

**MS. Marco soporte para facilitar el montaje**

	A	B	E	H	h
MS-443	443	615	60	360	70
MS-553	553	725	60	450	70
MS-701	701	875	60	590	90
MS-891	891	1065	60	750	90
MS-1086	1086	1260	60	900	90

**PA.Placa de adaptación para montaje de accesorios, en extractores de tejado**

	A	ØC	ØD	E	H	ØO	N
PA-440/250	440	280	249	20	360	M.6	4x90°
PA-550	550	395	354	20	450	M.6	8x45°
PA-700/500	700	560	499	20	590	M.10	12x30°
PA-890/630	890	690	629	20	750	M.10	12x30°
PA-1085	1088	770	704,5	20	900	M.10	16x22°30'

# CHT/ATEX CVT/ATEX

**Extractores centrifugos de tejado con salida horizontal o vertical, con Certificación ATEX y posible marcado Ex e, Ex d, Ex tc y Ex tb**

**Ex "e" marcado:**  $\text{CE} \text{Ex} \text{II} 2\text{G} \text{Ex} \text{e}$   
**Ex "d" marcado:**  $\text{CE} \text{Ex} \text{II} 2\text{G} \text{Ex} \text{d}$   
**Ex tc marcado:**  $\text{CE} \text{Ex} \text{II} 3\text{D} \text{Ex} \text{tc}$   
**Ex tb marcado:**  $\text{CE} \text{Ex} \text{II} 2\text{D} \text{Ex} \text{tb}$   
**Organismo notificado:** L.O.M.  
**Nº de identificación:** LOM3ATEX147



CHT



CVT

CHT: Extractores centrifugos de tejado, con salida de aire horizontal y sombrerete de aluminio, Certificación ATEX con motor antiexplosivo CEE ExII2G Ex e, antideflagrante CEE ExII2G Ex d, Ex tc, o Ex tb para trabajar en atmósferas explosivas de gas o polvo.

CVT: Extractores centrifugos de tejado, con salida de aire vertical y sombrerete de aluminio, Certificación ATEX con motor antiexplosivo CEE ExII2G Ex e, antideflagrante CEE ExII2G Ex d, Ex tc, o Ex tb para trabajar en atmósferas explosivas de gas o polvo.

**Ventilador:**

- Base soporte ATEX con boca de aspiración de cobre según norma EN-14986:2007
- Turbina con álabes a reacción
- Rejilla de protección antipájaros
- Sombrerete deflector antilluvia en aluminio

**Motor:**

- Motores clase F, con rodamientos a bolas con certificación ATEX, antiexplosivos Ex e, antideflagrante Ex d, Ex tc, o Ex tb
- Trifásicos 230/400V.-50Hz.(hasta 4 kW) y 400/690V.-50Hz.(potencias superiores a 4 kW)
- Temperatura máxima del aire a transportar: -20°C.+ 80°C.

**Acabado:**

- Anticorrosivo en chapa de acero galvanizado y aluminio

**Bajo demanda:**

- Motores con PTC incorporada
- Bobinados especiales para diferentes tensiones y frecuencias
- Construcción ATEX para diferentes categorías
- Extractores con motor de 2 velocidades
- Motores monofásicos antideflagrantes Ex d

**Código de pedido**



CHT: Extractores centrifugos de tejado con salida de aire horizontal, certificación atex  
CVT: Extractores centrifugos de tejado con salida de aire vertical, certificación atex

Tamaño turbina

Número de polos motor  
4=1400 r/min. 50 Hz  
6=900 r/min. 50 Hz

T=Trifásico

Ex-e: marcado:  
 $\text{CE} \text{Ex} \text{II} 2\text{G} \text{Ex} \text{e} \text{IIB} \text{T}3$   
Ex "d" marcado:  
 $\text{CE} \text{Ex} \text{II} 2\text{G} \text{Ex} \text{d} \text{IIB} \text{T}5$   
Ex tc marcado:  
 $\text{CE} \text{Ex} \text{II} 3\text{D} \text{Ex} \text{tc}$   
Ex tb marcado:  
 $\text{CE} \text{Ex} \text{II} 2\text{D} \text{Ex} \text{tb}$

**Marcado:**

- $\text{CE} \text{Ex} \text{II} 2\text{G} \text{c}$
- $\text{CE} \text{Ex} \text{II} 2\text{D} \text{c}$
- $\text{CE} \text{Ex} \text{II} 3\text{D} \text{c}$

**Características técnicas**

Modelo	Velocidad (r/min)	Intensidad máxima admisible (A)		Potencia instalada (kW)	Caudal máximo (m³/h)	Nivel sonoro dB(A)		Peso aprox. (Kg)
		230V	400V			Aspiración	Descarga	
CHT/ATEX CVT/ATEX 200-4T	1370	2,08	1,20	0,25	1450	37	43	25
CHT/ATEX CVT/ATEX 225-4T	1370	2,08	1,20	0,25	2100	41	47	25
CHT/ATEX CVT/ATEX 225-6T	910	2,42	1,40	0,25	1400	30	36	26
CHT/ATEX CVT/ATEX 250-4T	1370	2,08	1,20	0,25	3100	45	50	34
CHT/ATEX CVT/ATEX 250-6T	910	2,42	1,40	0,25	2000	33	40	35
CHT/ATEX CVT/ATEX 315-4T	1410	2,94	1,70	0,55	4950	48	54	39
CHT/ATEX CVT/ATEX 315-6T	935	2,77	1,60	0,37	3200	37	43	39
CHT/ATEX CVT/ATEX 400-4T	1410	3,81	2,20	0,75	7000	55	61	57
CHT/ATEX CVT/ATEX 400-6T	935	2,77	1,60	0,37	4500	44	50	56
CHT/ATEX CVT/ATEX 450-4T	1400	6,93	4,00	1,50	10200	59	64	66
CHT/ATEX CVT/ATEX 450-6T	935	2,77	1,60	0,37	6900	47	54	59
CHT/ATEX CVT/ATEX 500-6T	910	5,89	3,40	1,10	12000	51	57	103
CHT/ATEX CVT/ATEX 560-6T	940	9,35	5,40	2,20	17300	54	61	126
CHT/ATEX CVT/ATEX 630-6T	950	18,88	10,90	4,00	24700	58	64	166

(1) Los valores de los niveles sonoros, son presiones en dB(A), medidos a 6 metros, y a 2/3 del caudal máximo (2/3 Qmáx.)

**Características acústicas**

Los valores indicados, se determinan mediante medidas de nivel de presión y potencia sonora en dB(A) obtenidas en campo libre a una distancia de 6 mts.

**Espectro de potencia sonora Lw(A) en dB(A) por banda de frecuencia en Hz**

Valores tomados a la aspiración con 2/3 caudal máximo (2/3Qmax).

Modelo	63	125	250	500	1000	2000	4000	8000
200	35	41	52	55	56	52	50	44
225-4	42	51	56	56	60	59	52	46
225-6	31	40	45	45	49	48	41	35
250-4	46	55	60	60	64	63	56	50
250-6	34	43	48	48	52	51	44	38
315-4	50	56	62	62	65	68	59	53
315-6	39	45	51	51	54	57	48	42
315-8	35	41	47	47	50	53	44	38
400-4	57	63	69	69	72	75	66	60
400-6	46	52	58	58	61	64	55	49
400-8	42	48	54	54	57	60	51	45
450-4	62	69	74	74	78	77	70	65
450-6	50	57	62	62	66	65	58	53
450-8	46	53	58	58	62	61	54	49
450-12	35	42	47	47	51	50	43	38
500-6	54	60	65	66	70	69	62	55
500-8	47	53	58	59	63	62	55	48
500-12	39	45	50	51	55	54	47	40
560-6	57	63	68	69	73	72	65	58
560-8	49	55	60	61	65	64	57	50
560-12	42	48	53	54	58	57	50	43
630-6	61	67	72	73	77	76	69	62
630-8	53	59	64	65	69	68	61	54
630-12	46	52	57	58	62	61	54	47

Valores tomados a la descarga con 2/3 caudal máximo (2/3Qmax).

Modelo	63	125	250	500	1000	2000	4000	8000
200	39	44	58	60	61	61	56	51
225-4	41	50	60	64	67	64	57	51
225-6	30	39	49	53	56	53	46	40
250-4	44	53	63	67	70	67	60	54
250-6	34	43	53	57	60	57	50	44
315-4	49	61	69	71	72	72	64	56
315-6	38	50	58	60	61	61	53	45
315-8	34	46	54	56	57	57	49	41
400-4	56	68	76	78	79	79	71	63
400-6	45	57	65	67	68	68	60	52
400-8	41	53	61	63	64	64	56	48
450-4	60	72	80	82	83	80	73	65
450-6	50	62	70	72	73	70	63	55
450-8	45	57	65	67	68	65	58	50
450-12	35	47	55	57	58	55	48	40
500-6	50	64	72	76	75	72	66	60
500-8	43	57	65	69	68	65	59	53
500-12	35	49	57	61	60	57	51	45
560-6	54	68	76	80	79	76	70	64
560-8	46	60	68	72	71	68	62	56
560-12	39	53	61	65	64	61	55	49
630-6	57	71	79	83	72	79	73	67
630-8	50	64	72	76	72	72	66	60
630-12	42	56	64	68	67	64	58	52

Para obtener los espectros de potencia sonora Lwa en dB(A) en la aspiración a caudal máximo (Qmax), sumar el nivel de presión sonora LpA dado en las curvas características, los valores de la tabla siguiente:

Banda de frecuencia en Hz							
63	125	250	500	1000	2000	4000	8000
2	9	15	15	18	18	11	5

**Dimensiones mm**

**CHT**

Modelo	A	øD*	øF	G	H	øl
CHT-200	552	250	570	450	360	12
CHT-225	570	250	570	450	360	12
CHT-250	632	355	726	560	450	12
CHT-315	682	355	726	560	450	12
CHT-400	755	500	856	710	590	12
CHT-450	770	500	856	710	590	12
CHT-500	846	630	1075	900	750	14
CHT-560	1035	710	1300	1100	900	14
CHT-630	1098	710	1300	1100	900	14

(\*) Diámetro nominal tubería recomendada

**CVT**

Modelo	A	A1	øD*	øF	G	H	øl
CVT-200	500	308	250	530	450	360	12
CVT-225	517	308	250	530	450	360	12
CVT-250	580	380	355	705	560	450	12
CVT-315	630	380	355	705	560	450	12
CVT-400	690	475	500	900	710	590	12
CVT-450	705	475	500	900	710	590	12
CVT-500	775	545	630	1100	900	750	14
CVT-560	956	676	710	1295	1100	900	14
CVT-630	1017	676	710	1295	1100	900	14

(\*) Diámetro nominal tubería recomendada

**Curvas características**

Q= Caudal en m³/h, m³/s y cfm.

Pe= Presión estática en mmH<sub>2</sub>O, Pa e inwg.

Los niveles sonoros L<sub>p</sub> (dB(A)) indicados en las curvas, son presiones medidas a 6 metros, a la aspiración y en campo libre.

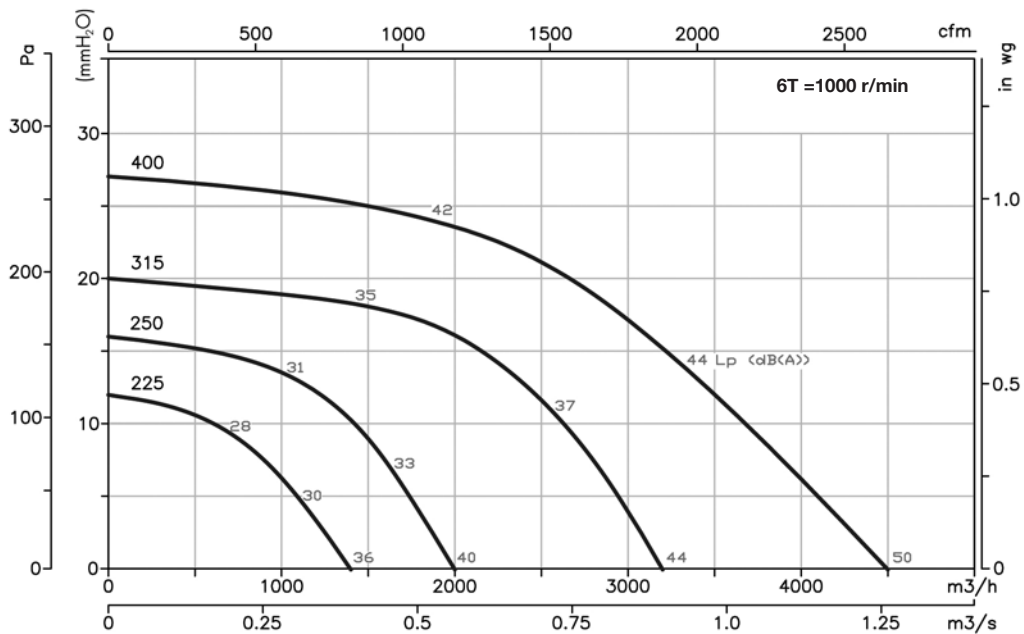
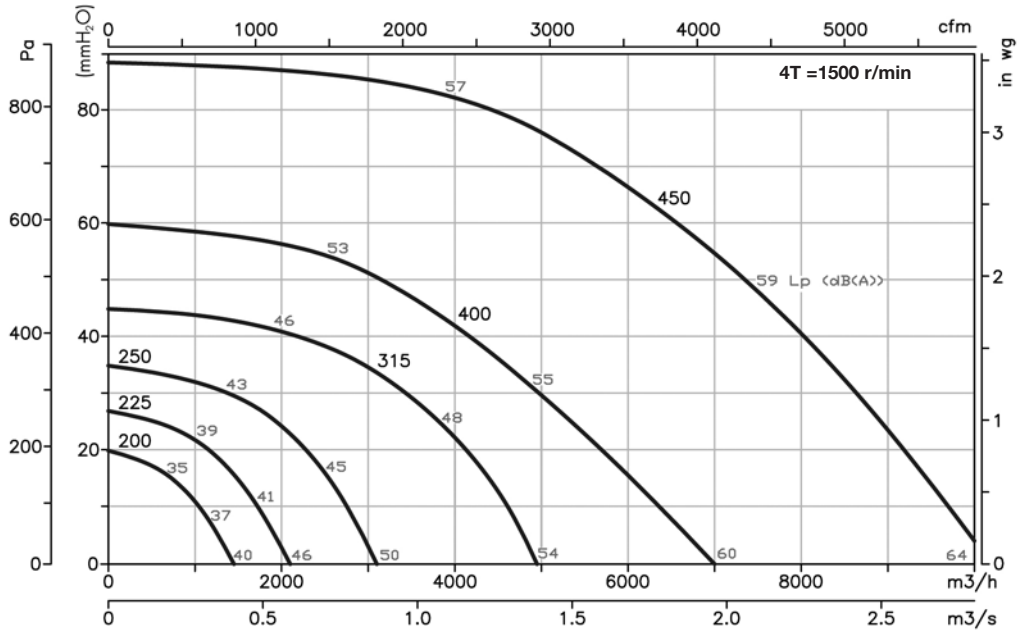

**Curvas características**

Q= Caudal en m³/h, m³/s y cfm.

Pe= Presión estática en mmH2O, Pa e inwg.

Los niveles sonoros Lp (dB(A)) indicados en las curvas, son presiones medidas a 6 metros, a la aspiración y en campo libre.

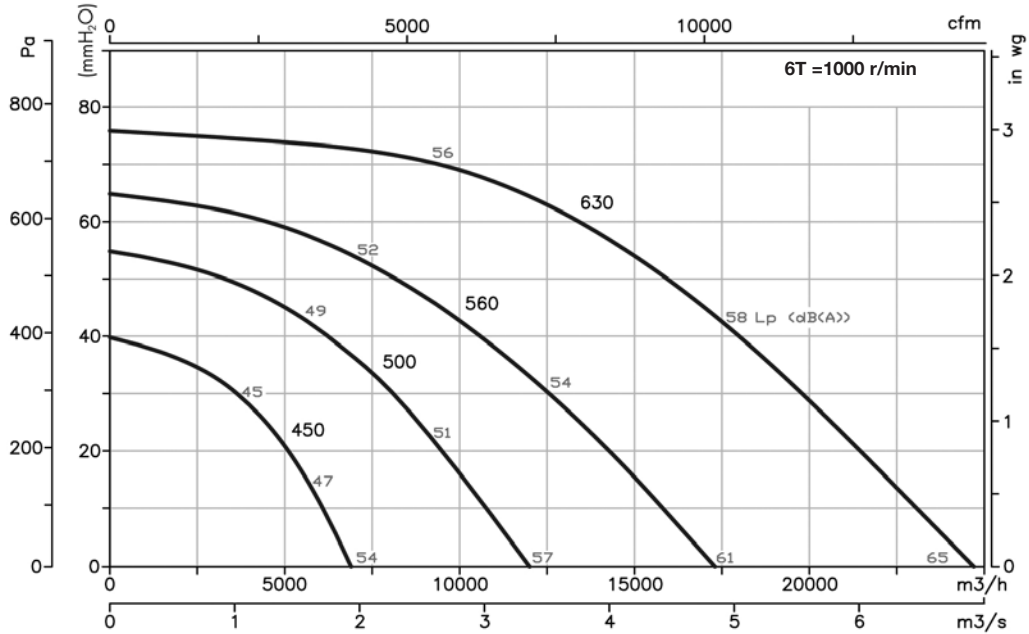

**Variación de la presión sonora según distancia**

El nivel sonoro puede variar dependiendo de la estructura de la cubierta o tejado.

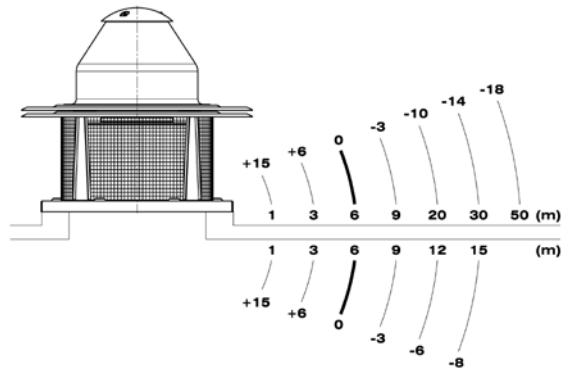

**Accesorios**

Ver apartado accesorios.



INT



AR



VSD3/A-RFT  
VSD1/A-RFM



CUADROS



B



MS



PA



PT



S



INT-ATEX

# KIT SOBREPRESIÓN

**El sistema de presurización de escaleras, vías de escape o de confinamiento, permite controlar de forma automática el caudal y mantener una presión diferencial de 50 Pa en una sola etapa, según norma UNE EN 12101-6-2006**

KIT SOBREPRESIÓN DE ESCALERAS  
Para equipos trifásicos



## KIT SOBREPRESIÓN DE ESCALERAS

- Kit sobrepresión de escaleras, formado por un cuadro de control (BOXPRES KIT) y unidades de impulsión (CJHCH o CJBD), para la presurización de las escaleras y rutas de escape. También disponible para equipos monofásicos NEOLINEO Y CJBC.

## KIT SOBREPRESIÓN CON VENTILADOR DE RESERVA

- Kit de sobrepresión con ventilador de reserva, formado por un cuadro de control (BOXPRES KIT II), que incorpora un sistema de conmutación automático para mantener la sobrepresión en caso de fallo del ventilador principal, y unidades de impulsión de aire con ventilador de reserva serie TWIN o CJHCH/DUPLEX.

KIT SOBREPRESIÓN DE ESCALERAS  
Para equipos monofásicos



## BOXPRES



- Fácil instalación
- Solución compacta y autónoma
- Mantenimiento preventivo
- Fácil puesta en marcha
- Instalación segura y funcional



- El buen funcionamiento de los sistemas de presurización, depende no solo del buen diseño de los mismos, sino también de la buena regulación que realice el sistema, por lo que es de vital importancia contar con elementos de regulación calibrados y de gran precisión, que permitan simultanear las dos situaciones presentes en caso de incendio, de forma rápida y estable.
- El cuadro de control BOXPRES, además de cumplir con las máximas exigencias, simplifica al máximo el trabajo del instalador.

Incluye:

- Variador de frecuencia programado a 50 Pa
- Sonda de presión diferencial
- Magneto térmico
- Led de línea y fallo
- Pulsador de chequeo

BOXPRES, es un equipo con todas sus conexiones entre sí realizadas y probadas

- Listo para funcionar y desempeñar su función sobre el control de la presión de la instalación.
- Posibilidad de chequeo de la instalación para evitar fallos
- Solo se debe conectar la línea de alimentación, el ventilador de impulsión y la señal de incendio.

Los cuadros para equipos monofásicos incluyen:

- Regulador de tensión programado a 50 Pa
- Sonda de presión diferencial externa al equipo.

KIT SOBREPRESIÓN CON  
VENTILADOR DE RESERVA



## Código de pedido

**KIT SOBREPRESIÓN — 7.100**

Kit sobrepresión: Conjunto de sobrepresión para escaleras  
Kit sobrepresión II: Conjunto de sobrepresión con ventilador de reserva

Caudal máximo

## Características técnicas

Modelo	Alimentación	Salida	Unidad de impulsión	Caudal (m³/h)	Nivel sonoro irradiado * dB(A)
KIT SOBREPRESION-1060-LED	230 Vac II	230 Vac II	NEOLINEO-200	1060	38
KIT SOBREPRESION-2300-LED	230 Vac II	230 Vac II	NEOLINEO-315	2300	47
KIT SOBREPRESION-2880-LED	230 Vac II	230 Vac II	CJBC-2828-6M 1/3	2880	61
KIT SOBREPRESION-7100-LED	230 Vac II	230 Vac III	CJHCH-45-4T-0,5	7100	55
KIT SOBREPRESION-7800-LED	230 Vac II	230 Vac III	CJBD-3333-6T-1,5	7800	55
KIT SOBREPRESION-12900-LED	230 Vac II	230 Vac III	CJHCH-56-4T-1	12900	60
KIT SOBREPRESION-17000-LED	230 Vac II	230 Vac III	CJHCH-63-4T-1,5	17000	61
KIT SOBREPRESION-7100-BOX	400 Vac III	400 Vac III	CJHCH-45-4T-0,5	7100	55
KIT SOBREPRESION-7800-BOX	400 Vac III	400 Vac III	CJBD-3333-6T-1,5	7800	55
KIT SOBREPRESION-12900-BOX	400 Vac III	400 Vac III	CJHCH-56-4T-1	12900	60
KIT SOBREPRESION-17000-BOX	400 Vac III	400 Vac III	CJHCH-63-4T-1,5	17000	61
KIT SOBREPRESION II-6240-BOX	400 Vac III	400 Vac III	TWIN-12/12-6T-1,5	6240	55
KIT SOBREPRESION II-9520-BOX	400 Vac III	400 Vac III	TWIN-15/15-6T-3	9520	54
KIT SOBREPRESION II-12900-BOX	400 Vac III	400 Vac III	CJHCH/DUPLEX-56-4T-1-H	12900	60
KIT SOBREPRESION II-17000-BOX	400 Vac III	400 Vac III	CJHCH/DUPLEX-63-4T-1,5-H	17000	61
SI-PRESIÓN TPDA c/DISPLAY	24V ac/24V dc	0-10V/4-20mA			
BOXPRES KIT-3A 230Vac	230 Vac II	230 Vac II			
BOXPRES KIT-10A 230Vac	230 Vac II	230 Vac II			
BOXPRES KIT-0.37kW 230Vac	230 Vac II	230 Vac III			
BOXPRES KIT-0.75kW 230Vac	230 Vac II	230 Vac III			
BOXPRES KIT-1.5kW 230Vac	230 Vac II	230 Vac III			
BOXPRES KIT-2.2kW 230Vac	230 Vac II	230 Vac III			
BOXPRES KIT-0.75kW 400Vac	400 Vac III	400 Vac III			
BOXPRES KIT-1.5kW 400Vac	400 Vac III	400 Vac III			
BOXPRES KIT-2.2kW 400Vac	400 Vac III	400 Vac III			
BOXPRES KIT II-1.5kW 400Vac	400 Vac III	400 Vac III			
BOXPRES KIT II-2.2kW 400Vac	400 Vac III	400 Vac III			

## Dimensiones mm

### CJHCH

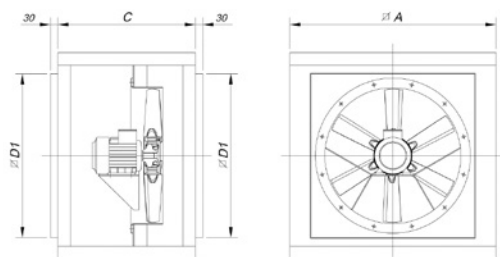

Modelo	ØA	C	ØD1
CJHCH-40/45/50	700	550	565
CJHCH-56/63	825	550	690

### CJBD

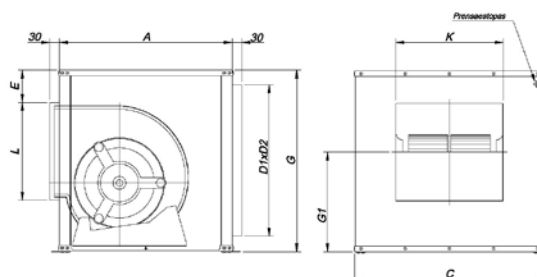

Modelo	Equiv. pulgadas	A	B	C	E	D1xD2	G1	L	K
CJBD-3333	12/12	650	650	700	92	556X606	379	358	400

## Dimensiones mm

### TWIN

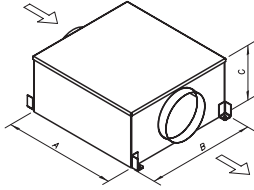

Modelo	A	B	C
TWIN-12/12	1103	1139	610
TWIN 15/15	1279	1639	698

### CJHCH/DUPLEX

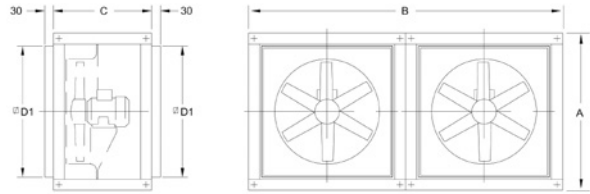

Modelo	ØA	B	C	ØD1
CJHCH/DUPLEX-56/63	825	1650	550	690

### NEOLINEO

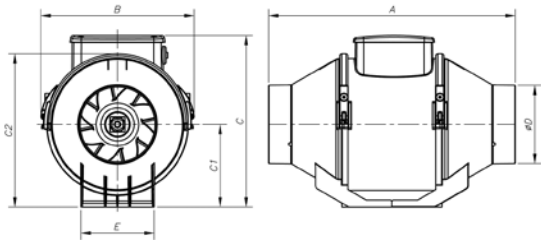

Modelo	A	B	C	C1	C2	øD	E
NEOLINEO-200	300	234,5	260,5	125,5	235	196	140
NEOLINEO-315	448	361,5	392,5	188,5	359	312	220,5

### CJBC

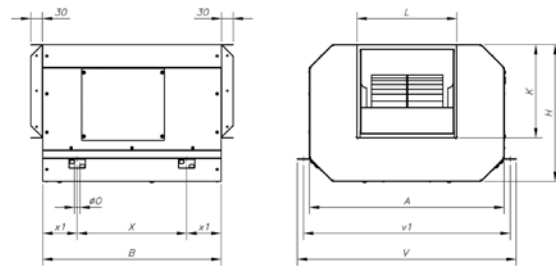

Modelo	A	B	H	K	L	øO	V	v1	X	x1
CJBC-2828-6M-1/3	696	645	460	290	320	15	755	725	445	100

## BOXPRESS KIT SOBREPRESIÓN

### Características técnicas y dimensiones

Modelo	Potencia (kW)	Alimentación (V/Hz)	Salida (V/Hz)	Intensidad salida (A)	Tamaño	Medidas (largo x ancho x fondo)
BOXPRES KIT-3A 230Vac	-	230 Vac II	230 Vac II	3	-	255 x 170 x 140 mm
BOXPRES KIT-10A 230Vac	-	230 Vac II	230 Vac II	10	-	255 x 170 x 140 mm
BOXPRES KIT-0,75kW 230Vac	0,75	230 V II / 50Hz	230 V III / 50Hz	4,3	1	270 x 270 x 170 mm
BOXPRES KIT-1,5kW 230Vac	1,5	230 V II / 50Hz	230 V III / 50Hz	7	1	270 x 270 x 170 mm
BOXPRES KIT-0,75kW 400Vac	0,75	400 V III / 50Hz	400 V III / 50Hz	2,2	1	270 x 270 x 170 mm
BOXPRES KIT-1,5kW 400Vac	1,5	400 V III / 50Hz	400 V III / 50Hz	4,1	1	270 x 270 x 170 mm
BOXPRES KIT-2,2kW 400Vac	2,2	400 V III / 50Hz	400 V III / 50Hz	5,8	2	360 x 360 x 205 mm

### Prensaestopas de entrada cable a equipo

#### BOXPRES KIT-3A / KIT-10A

Conexión alimentación y motor

Regulador



Sonda



Conexión de presión

#### BOXPRES KIT tamaño 1 y 2

M 20 x 1,5mm

Conexión Alimentación y motor

M 12 x 1,5mm

Conexión Señal Incendio

Conexión de presión





## BOXPRESS KIT SOBREPRESIÓN II

Para equipos con ventilador de reserva.

### Características técnicas y dimensiones

Modelo	Potencia (kW)	Alimentación (V/Hz)	Salida (V/Hz)	Intensidad salida (A)	Tamaño	Medidas (largo x ancho x fondo)
BOXPRES KIT II - 1,5kW 400Vac	1,5	400 V III / 50Hz	400 V III / 50Hz	4,1	1	270 x 270 x 170 mm
BOXPRES KIT II - 2,2kW 400Vac	2,2	400 V III / 50Hz	400 V III / 50Hz	5,4	2	360 x 360 x 205 mm

\* Los dos motores nunca funcionan simultáneamente

#### Prensaestopas de entrada cable a equipo

#### BOXPRES KIT tamaño 1 y 2

M 20 x 1,5mm  
Conexión Alimentación y motor

M 12 x 1,5mm  
Conexión Señal Incendio  
Conexión de presión



### Ejemplo de aplicación

Método de control de humo por Sobrepresión, este sistema consiste en la presurización mediante inyección de aire en habitáculos que son utilizados como vías de escape de personas en caso de incendio, tales como cajas de escalera, pasillos, corredores, elevadores, etc. Sobre todo en edificios de altura con gran ocupación. Este método está basado en el control del humo mediante la velocidad del aire y la barrera artificial que crea la sobre presión del aire sobre el humo, para que este no pueda entrar en las vías de escape.

# ACCESORIOS

<b>INT</b>  Interruptores de seguridad paro-marcha, para cumplir la Norma UNE-EN 60204-1 195	<b>Interruptor ATEX</b>  Interruptor ATEX paro-marcha según directivas 94/9/EC y 2006/95/EC 195	<b>AR</b>  Arrancadores suaves para motores trifásicos 195	<b>VSD3/A-RFT VSD1/A-RFM</b>  Variadores electrónicos de velocidad 196	<b>KME</b>  Kit mando externo de paro, marcha y control de velocidad para los convertidores de frecuencia VSD1/A-RFM y VSD3/A-RFT 197
<b>GMP</b>  Cuadro eléctrico de arranque y protección de ventiladores con motor trifásico, con pulsadores de paro y marcha 197	<b>GMM</b>  Cuadro eléctrico de arranque y protección de sobrecarga y cortocircuito de ventiladores trifásicos, con mando rotativo 197	<b>CUADROS ELÉCTRICOS</b>  Cuadros eléctricos 197	<b>PL</b>  Persianas de sobrepresión 198	<b>P</b>  Persianas de sobrepresión en aluminio 198
<b>R</b>  Rejilla de protección para la aspiración de ventiladores helicoidales 198	<b>RI</b>  Rejilla de protección para la impulsión de ventiladores helicoidales. 199	<b>RT</b>  Rejilla de protección para la aspiración o impulsión de ventiladores helicoidales tubulares. 199	<b>RPA</b>  Rejilla de protección para la aspiración de ventiladores centrifugos 199	<b>BTUB</b>  Brida de acoplamiento para ventiladores helicoidales 199
<b>PV</b>  Pabellón de aspiración con rejilla incorporada 199	<b>B</b>  Brida de acoplamiento para ventiladores centrifugos 200	<b>BD</b>  Brida de acoplamiento doble y elástica para ventiladores centrifugos 201	<b>BIC</b>  Brida conversión de rectangular a circular, para ventiladores centrifugos 201	<b>BAC</b>  Brida de acoplamiento doble y elástica para ventiladores helicoidales 202
<b>PS</b>  Conjunto de pies soporte, para ventiladores tubulares. 202	<b>MS</b>  Marco soporte para facilitar el montaje en obra 202	<b>PA</b>  Placa de adaptación para montaje de accesorios, en extractores de tejado 202	<b>PT</b>  Obturadores de cierre automático para trabajo vertical 203	<b>OP</b>  Obturadores de sobrepresión para extractores de tejado 203
<b>ACE/ATEX</b>  Acoplamiento elástico para amortiguar vibraciones 203	<b>REG</b>  Registro de regulación manual 203	<b>CJACUS</b>  Cajas acústicas para ventiladores centrifugos 204	<b>S</b>  Silenciadores para acoplar a la aspiración o impulsión 204	<b>SENSORES INTELIGENTES</b>  207

# INT

Interruptores de seguridad paro-marcha para cumplir la Norma UNE-EN 60204-1



Características:

- Interruptores para instalar al lado del ventilador y de esta forma poder cortar la corriente antes de manipular el ventilador
- Protección IP65
- Ventiladores monofásicos o trifásicos, utilizar interruptor de 3 polos (3CA).
- Ventiladores trifásicos de dos velocidades, utilizar interruptor de 6 polos (6CA).

Modelo	Intensidad (A)	(kW)	Entrada cables (mm)	Modelo	Intensidad (A)	(kW)	Entrada cables (mm)
INT-CA 10/3CA	20	5,5	19	INT-CA 10/6CA	20	5,5	19
INT-KG 10/3CA	20	5,5	23	INT-KG 10/6CA	20	5,5	23
INT-KG 20/3CA	25	7,5	29	INT-KG 20/6CA	25	7,5	29
INT-KG 32/3CA	32	11	29	INT-KG 32/6CA	32	11	29
INT-KG 41/3CA	40	15	37,5	INT-KG 41/6CA	40	15	37,5
INT-KG 64/3CA	63	22	37,5	INT-KG 64/6CA	63	22	37,5
INT-KG 80/3CA	80	30	37,5	INT-KG 80/6CA	80	30	37,5
INT-KG 100/3CA	100	37	37,5	INT-KG 100/6CA	100	37	37,5



# Interruptor ATEX

Interruptor ATEX paro-marcha según directivas 94/9/EC y 2006/95/EC

Características:

- II 3G Ex nR IIC T6 Gc
- II 2D Ex tb IIIC T XX °C Db IP66
- Protección IP66
- Construidos en termoplástico antiestático
- Interruptores de 3 polos para motores trifásicos a una tensión de línea máxima de 500 V.

Modelo	Intensidad máx zona 21-22 (Polvo) (A)	Intensidad máx zona 2 (Gas) (A)	Tensión máxima (V)	Potencia máxima motor 400V (kW)	Ø Entrada cable (mm)
INT/ATEX 16/3CA	16	10	500	5,5	10÷14
INT/ATEX 25/3CA	25	20	500	7,5	12÷18
INT/ATEX 40/3CA	40	32	500	15,0	12÷18
INT/ATEX 63/3CA	63	50	500	22,0	16÷25



# AR

Arrancadores suaves para motores trifásicos.

Características:

- Especialmente diseñados para reducir el pico de intensidad producido durante el arranque de ventiladores con motores trifásicos
- Tensión de alimentación 400V + - 10% 50/60Hz
- Montado en caja para carril DIN-35
- Posibilidad de ajustar el par de arranque, tiempo de aceleración y tiempo de desaceleración

Modelo	AR-2	AR-4	AR-7,5	AR-10	AR-15	AR-20	AR-30
Tensión de alimentación	400 V ±10% 50/60 Hz						
Potencia motor en kW a 400 V	1,5	3	5,5	7,5	11	15	22
Mínima potencia motor	40% de la potencia nominal del motor			20% de la potencia nominal del motor			
Fusibles externos (rápidos) en (A)	16	25	35	25	35/40	50	63
Corriente nominal en (A)	3,5	6,5	12	17	25	32	45
Rango de ajuste del par de arranque	De 0 al 80%						
Rango de ajuste del tiempo de arranque	De 0,5 a 12 s			De 0,5 a 10 s			
Par de frenado	Nivel fijado al 70%						
Rango de ajuste del tiempo de desaceleración	De 0,5 a 12 s			De 0,5 a 10 s			
Tiempo de inicialización	200 ms						
Temperatura de trabajo	0°C....45°C						
Temperatura de almacenamiento	-25°C....75°C						
Grado de protección	IP20						
Condiciones de ambiente	Sobretensión categoría III, Grado de polución 2						
Reducción de potencia con la temperatura máx.	1% por cada 1°C de aumento de la temperatura máxima						
Altura máxima de montaje	Hasta 1000 m						
Reducción de potencia con la altura máxima.	0,5% por cada 100 m a partir de 1000 m.						
Humedad	93% máximo sin condensación						
Ciclos máximos por horas (3 x I nom, 10 seg)	90/h	60/h	30/h	60/h	40/h	30/h	20/h
Peso en kg.	0,4			1,0			
Dimensiones	Ancho (W) mm	45			45		52,5
	Alto (H) mm	73			173		178
	Profundo (D) mm	122			152		158
Montaje	Anclaje A x B			Sobre guía DIN			



# VSD3/A-RFT VSD1/A-RFM

Variadores electrónicos de velocidad para motores AC

**Características:**

- Convertidores para la variación de velocidad mediante tensión y frecuencia, de ventiladores helicoidales y centrífugos con motores trifásicos asíncronos
- Alimentación del convertidor:
  - . Monofásico (VSD1/A-RFM): 200-240V 50/60 Hz
  - . Trifásico (VSD3/A-RFT): 380-480V 50/60 Hz
- De acuerdo con la Directiva de Compatibilidad Electromagnética 2004/108/EC, la Directiva de Baja tensión 2006/95/EC y la Directiva de Seguridad de máquinas 2006/42/EC.
- De acuerdo con las normas: -EN 61800-3:2004: Accionamientos eléctricos de potencia de velocidad variable. Norma de producto relativa a CEM incluyendo métodos de ensayos específicos. -EN 61800-5-1:2003: Accionamientos eléctricos de potencia de velocidad variable. Requisitos de seguridad. Eléctricos, térmicos y energéticos. -EN 60204-1:2006: Seguridad de las máquinas. Equipo eléctrico de las máquinas. Requisitos generales. -EN 55011:2007: Límites y métodos de medida de las características relativas a las perturbaciones radioeléctricas de los aparatos industriales, científicos y médicos (ICM) que producen energía en radiofrecuencia. -EN 60529:1992: Especificaciones para los grados de protección en los recintos.
- Entrada paro/marcha para deshabilitar/habilitar el variador.
- Entrada 0-10V para el control de velocidad.
- Conexión a bus ModBus RTU disponible.
- Modelo estándar con grado de protección IP20. Disponible también en versión IP66 hasta 10 CV.

1. En general, todos los ventiladores SODECA con motor trifásico en ejecución normal, son adecuados para trabajar alimentados con convertidor de frecuencia estático (según IEC 60034-17). No obstante algunos motores requieren medidas especiales. La máxima frecuencia o velocidad de funcionamiento, nunca deberá exceder la de diseño del ventilador. Las aplicaciones con par cuadrático tales como ventiladores y bombas, cuando varía la velocidad, la potencia absorbida es directamente proporcional al cubo de la velocidad de rotación:  $P_{a_2} = P_{a_1} (n_2 / n_1)^3$
2. El aislamiento de los motores acoplados a los ventiladores es suficiente para trabajar sin restricciones con convertidor de frecuencia hasta tensiones de < 500 V. La utilización de filtros senoidales a la salida del convertidor, contribuirán en el buen funcionamiento del motor, minimizando averías y aumentando la vida útil del mismo. Se recomienda que para motores de tamaño > 225, éstos sean solicitados con devanados especiales para funcionar con convertidor de frecuencia.
3. La longitud de los cables de salida del convertidor al ventilador, influyen especialmente en las características de la tensión en bornes del motor. La definición de "cables largos" dependerá del valor nominal y tipo de convertidor, siendo necesario consultar la documentación técnica del fabricante.
4. Para los motores Antideflagrantes Ex-d, estos deben solicitarse para ser accionados mediante convertidor de frecuencia. El fabricante del motor pedirá información de la aplicación mediante un cuestionario, para definir los parámetros de trabajo. Además dichos motores deberán llevar incorporadas sondas PTC.
5. Los motores de seguridad aumentada Ex-e, no pueden accionarse con convertidor de frecuencia (para ello sería necesario la certificación conjunta motor y convertidor).

**VSD1/A-RFM**

Modelo		VSD1/A-RFM-0,5	VSD1/A-RFM-1	VSD1/A-RFM-2	VSD1/A-RFM-3
Potencia (CV)		0,50	1,00	2,00	3,00
Potencia (kW)		0,37	0,75	1,50	2,20
Intensidad máxima (A)		2,3	4,3	7,0	10,5
<b>Entrada</b>					
Tipo entrada		Monofásica	Monofásica	Monofásica	Monofásica
Voltage (V)		200-240 V	200-240 V	200-240 V	200-240 V
Frecuencia (Hz)		50-60 Hz	50-60 Hz	50-60 Hz	50-60 Hz
<b>Salida</b>					
Tipo Salida		Trifásica	Trifásica	Trifásica	Trifásica
Voltage (V)		200-240 V	200-240 V	200-240 V	200-240 V
Frecuencia (Hz)		0-500 Hz	0-500 Hz	0-500 Hz	0-500 Hz
Grados de protección		Estándar: IP20. Bajo pedido: IP66.			
Refrigeración		IP20: Forzada. IP66: Natural			

**VSD3/A-RFT**

Modelo		VSD3/A-RFT-1	VSD3/A-RFT-2	VSD3/A-RFT-3	VSD3/A-RFT-5.5	VSD3/A-RFT-7.5	VSD3/A-RFT-10	VSD3/A-RFT-15	VSD3/A-RFT-20	VSD3/A-RFT-25	VSD3/A-RFT-30
Potencia (CV)		1,00	2,00	3,00	5,50	7,50	10,00	15,00	20,00	25,00	30,00
Potencia (kW)		0,75	1,50	2,20	4,00	5,50	7,50	11,00	15,00	18,50	22,00
Intensidad máxima(A)		2,2	4,1	5,8	9,5	14,0	18,0	24,0	30,0	39,0	46,0
<b>Entrada</b>											
Tipo entrada		Trifásica	Trifásica	Trifásica	Trifásica	Trifásica	Trifásica	Trifásica	Trifásica	Trifásica	Trifásica
Voltage (V)		380-480 V	380-480 V	380-480 V	380-480 V	380-480 V	380-480 V	380-480 V	380-480 V	380-480 V	380-480 V
Frecuencia (Hz)		50-60 Hz	50-60 Hz	50-60 Hz	50-60 Hz	50-60 Hz	50-60 Hz	50-60 Hz	50-60 Hz	50-60 Hz	50-60 Hz
<b>Salida</b>											
Tipo Salida		Trifásica	Trifásica	Trifásica	Trifásica	Trifásica	Trifásica	Trifásica	Trifásica	Trifásica	Trifásica
Voltage (V)		380-480 V	380-480 V	380-480 V	380-480 V	380-480 V	380-480 V	380-480 V	380-480 V	380-480 V	380-480 V
Frecuencia (Hz)		0-500 Hz	0-500 Hz	0-500 Hz	0-500 Hz	0-500 Hz	0-500 Hz	0-500 Hz	0-500 Hz	0-500 Hz	0-500 Hz
Grados de protección		Estándar: IP20. Bajo pedido: IP66						IP20	IP20	IP20	IP20
Refrigeración		IP20 e IP55: Forzada. IP66: Natural									



## KME - 10K

Kit mando externo de paro, marcha y control de velocidad para los convertidores de frecuencia VSD1/A-RFM y VSD3/A-RFT

Características:

- Paro y marcha mediante pulsación del mando
- Visualización mediante LED de la posición de paro o marcha
- Memoria de la última posición de regulación de velocidad
- Posibilidad de montaje en superficie o empotrado



## GMP

Cuadro eléctrico de arranque y protección de ventiladores con motor trifásico, con pulsadores de paro y marcha

Características:

- Paro y marcha mediante pulsador
- Incorpora contactor y relé térmico regulable totalmente cableados, para protección del motor
- El pulsador de paro, se utiliza como rearme del relé térmico, en caso de disparo por sobrecarga
- Para montaje en superficie, protección IP-55

Para ventilador con motor trifásico 230V

Modelo	Intensidad de regulación (A)	Potencia motor 3x230V (kW)
GMP-0,2-0,33/230	1,2-1,8	0,25
GMP-02-0,75/230	1,8-2,8	0,37 / 0,55
GMP-02-1/230	2,8-4	0,75
GMP-02-1,5/230	4-6,3	1,10
GMP-02-2/230	5,6-8	1,50
GMP-04-3/230	7-10	2,20
GMP-04-4/230	8-12,5	3,00
GMP-04-5,5/230	11-17	4,00
GMP-04-7,5/230	15-23	5,50
GMP-04-10/230	22-32	7,50
GMP-06-12,5/230	25-40	9,20
GMP-06-15/230	25-40	11,00

Para ventilador con motor trifásico 400V

Modelo	Intensidad de regulación (A)	Potencia motor 3x400V (kW)
GMP-0,2-0,33/400	0,56-0,8	0,25
GMP-02-0,5/400	0,8-1,2	0,37
GMP-02-0,75/400	1,2-1,8	0,55
GMP-02-1,5/400	1,8-2,8	1,10
GMP-02-2/400	2,8-4	1,50
GMP-02-3/400	4-3	2,20
GMP-02-4/400	5,6-8	3,00
GMP-04-5,5/400	7-10	4,00
GMP-04-7,5/400	8-12,5	5,50
GMP-04-10/400	11-17	7,50
GMP-06-12,5/400	15-23	9,20
GMP-06-15/400	15-23	11,00
GMP-06-20/400	22-32	15,00
GMP-06-25/400	25-40	18,50



## GMM

Cuadro eléctrico de arranque y protección de sobrecarga y cortocircuito de ventiladores trifásicos, con mando rotativo

Características:

- Paro y marcha mediante mando rotativo con posibilidad de bloqueo con tres candados
- Incorpora relé térmico regulable para protección de sobrecarga y cortocircuito
- Para montaje en superficie, protección IP-55

Para ventilador con motor trifásico 400

Modelo	Intensidad de regulación (A)	Potencia motor 3x400V (kW)
GMM-01-1/400	1,6-2,5	0,75
GMM-01-2/400	2,5-4	1,10 1,50
GMM-01-3/400	4-6,3	2,20
GMM-01-5,5/400	6,3-10	3,00 4,00
GMM-01-7,5/400	10-16	5,50
GMM-01-10/400	16-20	7,50
GMM-01-15/400	20-25	11,00
GMM-01-20/400	25-32	15,00



## AET

Cuadro eléctrico de arranque estrella / triángulo y protección de ventiladores trifásicos, con pulsadores de paro y marcha

Características:

- Paro y marcha mediante pulsador
- Visualización de estado mediante pilotos luminosos
- Incorpora relé térmico regulable para protección del motor
- Totalmente cableado
- Caja metálica para montaje en superficie, protección IP-65

Para ventilador con motor trifásico 230V/400V Alimentación 3x230V

Modelo	Intensidad regulación relé térmico (A)	Potencia motor 3x230/400V (kW)
AET-01-3/230	4-6,3	2,2
AET-01-4/230	5-8	3,0
AET-01-5,5/230	7-10	4,0
AET-01-7,5/230	12-18	5,5
AET-01-10/230	12-18	7,5
AET-01-15/230	18-26	11,0
AET-01-20/230	24-36	15,0
AET-01-25/230	28-40	18,5
AET-02-30/230	34-50	22,0
AET-02-40/230	45-65	30,0
AET-02-50/230	63-85	37,0

Para ventilador con motor trifásico 400V/690V Alimentación 3x400V+N

Modelo	Intensidad regulación relé térmico (A)	Potencia motor 3x400/690V (kW)
AET-01-5,5/400	4-6,3	4,0
AET-01-7,5/400	5-8	5,5
AET-01-10/400	7-10	7,5
AET-01-15/400	12-18	11,0
AET-01-20/400	12-18	15,0
AET-02-30/400	18-26	18,5 22,0
AET-02-40/400	28-40	30,0
AET-02-50/400	34-50	37,0
AET-02-60/400	45-65	45,0
AET-02-75/400	45-65	55,0



## AD Cuadro eléctrico de arranque y protección de ventiladores con motor trifásico de 2 velocidades DAHLANDER

Características:

- Conmutador para la selección de la velocidad (1-0-2), velocidad lenta-paro-velocidad rápida
- Visualización de estado mediante pilotos luminosos
- Incorpora relé térmico regulable para protección del motor
- Totalmente cableado
- Caja metálica para montaje en superficie, protección IP-65

Para ventilador con motor trifásico 400V Dahlander.  
Alimentación 3x400V+N

Modelo	Intensidad regulación relé térmico	
	Velocidad rápida (A)	Velocidad lenta (A)
AD-01-2,5-1/400	1,6-2,5	0,63-1
AD-01-4-1,6/400	2,5-4	1-1,6
AD-01-4-2,5/400	2,5-4	1,6-2,5
AD-01-6-2,5/400	4-6	1,6-2,5
AD-01-9-2,5/400	6-9	1,6-2,5
AD-01-9-4/400	6-9	2,5-4
AD-02-13-4/400	9-13	2,5-4
AD-02-18-6/400	12-18	4-6
AD-02-18-9/400	12-18	6-9
AD-02-26-9/400	18-26	6-9
AD-02-36-9/400	24-36	6-9
AD-02-36-13/400	24-36	9-13
AD-02-40-18/400	28-40	12-18



## PL Persianas de sobrepresión en material plástico

Características:

- La persiana de sobrepresión se adapta directamente sobre la pared en que se instala el ventilador
- Apertura mediante sobrepresión por el flujo de aire
- Se cierran cuando el ventilador está en reposo
- Construcción en material plástico
- Velocidad máxima recomendable de 12m/seg. para los modelos 80,90 y 100

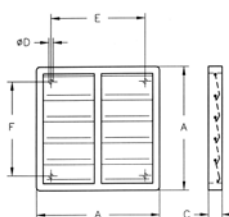

Modelo	Dimensiones				
	A	C	ØD	E	F
PL-20	240	28	5,2	193	167
PL-25	294	26	5	232	232
PL-31	347	26	5	276	276
PL-35	397	26	5	310	310
PL-40	459	26	5	364	364
PL-45	501	26	5	395	395
PL-50	549	31	5	445	445
PL-56	605	28	5	522	522
PL-63	696	31	5	626	626
PL-71	760	40	5	692	692
PL-80	840	40	5	772	772
PL-90	940	40	5	872	87
PL-100	1040	40	5	972	972



## P Persianas de sobrepresión en aluminio, construcción antichispas

Características:

- La persiana de sobrepresión se adapta directamente sobre la pared en que se instala el ventilador
- Apertura mediante sobrepresión por el flujo de aire
- Se cierran cuando el ventilador está en reposo
- Construcción en chapa de aluminio
- Velocidad máxima recomendable de 18m/seg. para los modelos 90 y 100

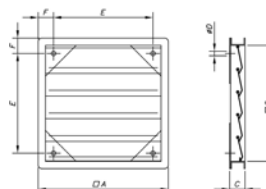

Modelo	Dimensiones					
	G	A	C	ØD	E	F
P 25	240	290	51	6	180	55
P 35	350	400	51	6	290	55
P 45	450	500	51	6	390	55
P 56	550	600	51	6	440	80
P 63	645	715	72	6	555	80
P 71	710	780	72	6	620	80
P 80	805	875	72	6	695	90
P 90	900	970	72	6	790	90
P 100	1000	1070	72	6	890	90



## R Rejilla de protección para la aspiración de ventiladores helicoidales.

Modelo	HC	HCH/HDF
R-35/B	-	35
R-40	-	40
R-45	-	45
R-56	-	56-4T/M-0,75, 56-4T-1, 56-6T/M-0,33, 56-6T-0,5, 56-6T-0,75
R-56 - 1,5	-	56-4T-1,5, 56-4T-2
R-63 - 0,5	-	63-4T-1, 63-6T/M-0,5, 63-6T-0,75
R-63 - 1,5	-	63-4T-1,5, 63-4T-2, 63-6T-1
R-63 - 4	-	63-4T-3, 63-4T-4
R-71	-	71-4T-1,5, 71-4T-2, 71-6T/M-0,75, 71-6T-1, 71-6T-1,5
R-71/C*	71	
R-71-3	-	71-4T-3, 71-4T-4
R-80	-	80-6T-1, 80-6T-1,5, 80-8T-0,5, 80-8T-0,75

Modelo	HC	HCH/HDF
R-80/C*	80	
R-80 - 5,5	-	80-4T-3, 80-4T-4, 80-4T-5,5, 80-6T-2, 80-6T-3, 80-8T-1
R-90	-	90-4T-4, 90-4T-5,5, 90-6T-2, 90-6T-3, 90-8T-1, 90-8T-1,5, 90-8T-2
R-90/C*	90	
R-90 - 7,5	-	90-4T-7,5, 90-4T-10, 90-6T-4, 90-8T-3
R-100	-	100-6T-3, 100-8T-1,5, 100-8T-2
R-100/C*	100	
R-100-7,5/C*	100 4T/H	
R-100 - 10	-	100-4T-7,5, 100-4T-10, 100-6T-4, 100-6T-5,5, 100-8T-1,5, 100-8T-2
R-100 - 20	-	100-4T-15, 100-4T-20

\* estos modelos se suministran con rejilla cuadrada

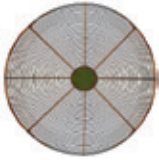

## RI

Rejilla de protección para la impulsión de ventiladores helicoidales.

Modelo	HCDF	HC	HCH/HDF	Modelo	HCDF	HC	HCH/HDF	Modelo	HCDF	HC	HCH/HDF
RI-25	25	25	-	RI-45	45	45	45	RI-71	-	71	71
RI-31	31	31	-	RI-50	50	50	-	RI-80	-	80	80
RI-35/C	35	35	-	RI-56	56	56	56	RI-90	-	90	90
RI-40	40	40	40	RI-63	-	63	63	RI-100	-	100	100



## RT

Rejilla de protección para la aspiración o impulsión de ventiladores helicoidales tubulares.

Modelo	HTP/HBA	HCT	HPX	Modelo	HTP/HBA	HCT	HPX	Modelo	HTP/HBA	HCT	HPX
RT-25	-	25	-	RT-45	-	45	45	RT-71	71	71	71
RT-31/B	-	31	-	RT-50	50	50	50	RT-80	80	80	80
RT-35	-	35	35	RT-56	56	56	56	RT-90	90	90	90
RT-40	-	40	-	RT-63	63	63	63	RT-100	100	100	100



## RPA

Rejilla de protección para la aspiración de ventiladores centrífugos

Características:

- Previene contra contactos con la turbina y posibles entradas de objetos, según norma UNE-EN ISO 12499:2010
- Construida en chapa de acero

Aplicable a los modelos

Modelo	CMA	CAS	CA	CMP	CMR
RPA-10	-	-	-	38	-
RPA-11	218	-	-	-	-
RPA-13	324	-	234	-	-
RPA-15	325/426	242	142	512	-
RPA-17	527	248	148	514	-
RPA-18	528	254	154	-	-
RPA-20	531	260	-	616	-
RPA-23	-	680	160/166/172	718	-
RPA-25	540/545	790	-	620/820	-
RPA-28	-	463/467	-	922	-
RPA-31	-	571/640/645/650/980/1080	-	1025	-
RPA-35	-	852/990/1090	-	1128	-
RPA-38	-	-	-	231	1031
RPA-42	-	856	-	1435	1135
RPA-44	-	1250/A	-	-	-
RPA-47	-	863/971	-	1640	1240
RPA-48	-	1456/A	-	-	-
RPA-52	-	-	-	1845	1445
RPA-55	-	-	-	-	-
RPA-60	-	-	-	2050	1650
RPA-65	-	1663/A	-	-	-
RPA-66	-	-	-	-	1856
RPA-73	-	1671/A-2071/A	-	2563	2063
RPA-81	-	2080/A	-	-	2271
RPA-88	-	-	-	-	2380
RPA-90	-	-	-	-	2590
RPA-100	-	-	-	-	28100



## BTUB

Brida de acoplamiento para ventiladores helicoidales

Modelo	HTP/HBA	HCT	HPX	HT	Modelo	HTP/HBA	HCT	HPX	HT	Modelo	HTP/HBA	HCT	HPX	HT
BTUB-250	-	25	-	25	BTUB-450	45	45	45	45	BTUB-710	71	71	71	71
BTUB-280	-	31	-	-	BTUB-500	50	50	50	50	BTUB-800	80	80	80	80
BTUB-315	31	-	-	31	BTUB-560	56	56	56	56	BTUB-900	90	90	90	90
BTUB-355	35	35	-	35	BTUB-630	63	63	63	63	BTUB-1000	100	100	100	100
BTUB-400	40	40	-	40										



## PV

Pabellón de aspiración aplicable a las series HEPT, HCT, HGT, HTP, THT

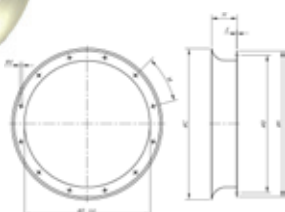

Modelo	øA	øB	ØC	øD	ød	E	M	H	Modelo	øA	øB	ØC	øD	ød	E	M	H
PV-31	398	355	426	320	10	15	8x45°	165	PV-80	904	860	915	797	12	2	16x22,5°	250
PV-35	438	395	435	359	10	15	8x45°	165	PV-90	1004	970	1015	894	14	2	16x22,5°	250
PV-40	484	450	507	401	12	15	8x45°	165	PV-100	1105	1070	1115	1003	14	2	16x22,5°	250
PV-45	534	500	555	450	12	15	8x45°	165	PV-125	1370	1320	1364	1240	14	2	20x18°	250
PV-50	584	560	617	504	12	15	12x30°	165	PV-140	1533	1470	1673	1413	15	3	20x18°	250
PV-56	664	620	667	565	12	15	12x30°	165	PV-160	1705	1680	1866	1585	19	3	24x15°	315
PV-63	734	690	757	634	12	15	12x30°	165	PV-180	1908	1830	1923	1788	19	3	24x15°	315
PV-71	812	770	816	711	12	2	16x22,5°	250	PV-200	2113	2080	2128	1993	19	3	24x15°	315



## B Brida de acoplamiento para ventiladores centrífugos

Características:

- Se adapta a la boca de aspiración y de impulsión
- Facilita la instalación al conducto

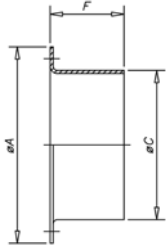

	ØA	ØC	F		ØA	ØC	F		ØA	ØC	F		ØA	ØC	F
B-52-E	100	52	67	B-200	260	200	60	B-355/1	430	355	80	B-500/5	590	500	80
B-63	110	63	60	B-224	280	224	60	B-355/2	430	355	80	B-560/1	650	560	80
B-80	150	80	60	B-250/1	310	250	80	B-355/3	430	355	80	B-560/2	650	560	80
B-80-E	150	80	60	B-250/2	310	250	80	B-355/4	430	355	80	B-560/3	650	560	80
B-100	150	100	60	B-250/3	310	250	80	B-400/1	480	400	80	B-630/1	720	630	80
B-100-E	170	100	60	B-250/4	310	250	80	B-400/2	480	400	80	B-630/2	720	630	80
B-112	160	112	60	B-250/5	310	250	80	B-400/3	480	400	80	B-630/3	720	630	80
B-125	180	125	60	B-280/1	350	280	80	B-400/4	480	400	80	B-630/4	720	630	80
B-140	190	140	60	B-280/2	350	280	80	B-450/1	530	450	80	B-710/1	800	710	80
B-150	210	150	60	B-280/3	350	280	80	B-450/2	530	450	80	B-710/2	800	710	80
B-160	220	160	60	B-315/1	380	315	80	B-450/3	530	450	80	B-710/3	800	710	80
B-160/1	220	160	60	B-315/2	380	315	80	B-500/1	590	500	80	B-800	890	800	100
B-160/2	310	160	80	B-315/3	380	315	80	B-500/2	590	500	80	B-900/1	1000	900	100
B-180	240	180	60	B-315/4	380	315	80	B-500/3	590	500	80	B-1000/1	1100	1000	100
B-180/1	240	180	60	B-315/5	380	315	80	B-500/4	590	500	80				

Descarga

Impulsión

Modelo	CHT CVT	CHRE	CMAT CMA	CB	CAST CAS	CA	CAM	CMP CTMP TCMP	CMC	CMT	CBP	CMR-X TCR/R TCR/CMR	CMRT	CMAT CMA	CA
B-52-E	-	-	-	-	-	-	-	-	-	-	-	-	-	-	234
B-63	-	-	-	-	-	-	-	-	-	-	-	-	-	218/324	142
B-80	-	-	218/324	-	-	-	-	-	-	-	-	-	-	325	-
B-80-E	-	-	-	-	-	-	-	-	-	-	-	-	-	-	148/154/160/166
B-100	-	-	325	-	-	234	-	-	-	-	-	-	-	426/527	-
B-100-E	-	-	-	-	242	142	-	-	-	-	-	-	-	-	172
B-112	-	-	426	-	248	148	-	512	-	-	-	-	-	-	-
B-125	-	-	527/528	-	254	154	-	-	-	-	-	-	-	528	-
B-140	-	-	-	-	-	-	-	514	-	-	-	-	-	-	-
B-150	-	-	531	-	260	160	-	-	628/630	-	-	-	-	531/540	-
B-160	-	-	-	-	-	-	-	616	-	-	-	-	-	-	-
B-160/1	-	722	-	-	680	-	-	-	-	-	-	-	-	-	-
B-160/2	-	-	-	-	-	-	-	-	-	-	-	625	-	-	-
B-180	-	825	540	-	790	166/172	540/545	718	-	922	-	-	-	545	-
B-180/1	-	-	545	-	-	-	-	-	-	-	-	-	-	-	-
B-200	-	-	-	820	463	-	-	620/820	835/840	1025	-	-	-	-	-
B-224	-	-	-	-	467	-	550/752	922	-	1128	-	622	-	-	-
B-250/1	-	-	-	-	571/640/645/650	-	-	-	-	1231	-	-	-	-	-
B-250/2	-	-	-	-	-	-	760	-	-	-	-	-	-	-	-
B-250/3	200/225	1131	-	-	-	-	-	1025	-	-	-	-	-	-	-
B-250/4	-	-	-	1428	-	-	-	-	-	-	-	-	-	-	-
B-250/5	-	-	-	-	980/1080	-	-	-	-	-	-	-	-	-	-
B-280/1	-	-	-	-	852	-	-	-	-	1435/1640	-	728	-	-	-
B-280/2	-	-	-	-	-	-	-	1128	-	-	-	-	-	-	-
B-280/3	-	-	-	-	990/1090	-	-	-	-	-	-	-	-	-	-
B-315/1	-	-	-	1733	-	-	-	-	-	-	-	-	1650	-	-
B-315/2	-	-	-	-	-	-	880	-	-	-	-	-	-	-	-
B-315/3	-	-	-	-	-	-	-	-	-	-	-	1031	-	-	-
B-315/4	-	-	-	-	-	-	-	1231	-	-	-	-	-	-	-
B-315/5	-	-	-	-	-	-	-	-	-	-	-	731	-	-	-
B-355/1	-	-	-	-	-	-	-	-	-	-	-	1135	1856	-	-
B-355/2	-	-	-	2240	863	-	-	-	-	-	-	-	-	-	-
B-355/3	250/315	1135/1240	-	-	856	-	-	1435	-	1845	-	-	-	-	-
B-355/4	-	-	-	-	1250/A	-	-	-	-	-	-	-	-	-	-
B-400/1	-	-	-	-	-	-	-	1640	-	-	-	-	-	-	-
B-400/2	-	-	-	-	-	-	-	-	-	-	-	1240	2063	-	-
B-400/3	-	-	-	-	971	-	-	-	-	2050	-	-	-	-	-
B-400/4	-	-	-	-	1456/A	-	-	-	-	-	-	-	-	-	-
B-450/1	-	-	-	-	-	-	-	1845	-	-	-	-	-	-	-
B-450/2	-	-	-	-	-	-	-	-	-	-	-	1445	-	-	-
B-450/3	-	-	-	-	-	-	-	-	-	-	1445	-	2271	-	-
B-500/1	-	-	-	-	-	-	-	2050	-	-	-	-	-	-	-
B-500/2	-	-	-	-	-	-	-	-	-	-	-	1650	-	-	-
B-500/3	-	-	-	-	-	-	-	-	-	-	1650	-	-	-	-
B-500/4	400/450	1445/1650	-	-	-	-	-	-	-	-	-	-	-	-	-
B-500/5	-	-	-	-	-	-	-	-	-	-	-	-	2380	-	-
B-560/1	-	-	-	-	-	-	-	-	-	1856	-	-	-	-	-
B-560/2	-	-	-	-	-	-	-	-	-	-	-	1856	-	-	-
B-560/3	-	-	-	-	1663/A	-	-	-	-	-	-	-	-	-	-
B-630/1	-	-	-	-	-	-	-	2563	-	-	-	-	-	-	-
B-630/2	-	-	-	-	-	-	-	-	-	-	-	2063	-	-	-
B-630/3	500	-	-	-	-	-	-	-	-	-	-	-	-	-	-
B-630/4	-	-	-	-	1671/A-2071/A	-	-	-	-	-	-	-	-	-	-
B-710/1	-	-	-	-	-	-	-	-	-	-	-	2271	-	-	-
B-710/2	560/630	-	-	-	-	-	-	-	-	-	-	-	-	-	-
B-710/3	-	-	-	-	2080/A	-	-	-	-	-	-	-	-	-	-
B-800	-	-	-	-	-	-	-	-	-	-	-	-	-	2380	-
B-900/1	-	-	-	-	-	-	-	-	-	-	-	-	-	2590	-
B-1000/1	-	-	-	-	-	-	-	-	-	-	-	-	-	28100	-





**BD**

**Brida de acoplamiento doble para ventiladores centrífugos**

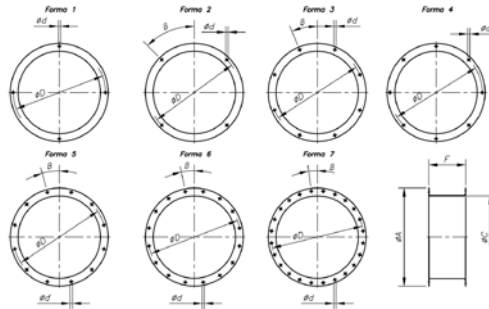

Características:

- Se adapta a la boca de aspiración
- Facilita la instalación al conducto con brida

	ØA	ØC	ØD	Ød	F	β	Forma
BD-200	260	200	225	7	80	15°	2
BD-224	280	224	254	7	80	-	1
BD-250/1	310	250	280	10	80	45°	2
BD-280	350	280	320	10	100	-	4
BD-315/3	390	315	355	10	100	22°30'	3
BD-355/3	430	355	395	10	100	22°30'	3
BD-400/1	480	400	450	12	100	22°30'	3
BD-400/2	480	400	450	12	100	22°30'	3
BD-450/1	530	450	500	12	100	22°30'	3
BD-450/2	530	450	500	12	100	22°30'	3
BD-500/2	590	500	560	12	100	15°	5
BD-560	650	560	620	12	120	15°	5
BD-630/2	720	630	690	12	120	15°	5
BD-710	800	710	770	12	120	11°15'	6
BD-800	890	800	860	12	140	11°15'	6
BD-900/1	1000	900	958	12	140	11°15'	6
BD-1000/1	1100	1000	1067	14	140	7°30'	7

Aplicable a los modelos

Modelo	CMP	CMR
BD-112	512	-
BD-140	514	-
BD-160	616	-
BD-180	718	-
BD-200	620/820	-
BD-224	922	-
BD-250/1	1025	-
BD-250/2	-	-
BD-280	1128	-
BD-315/1	-	-

Aplicable a los modelos

Modelo	CMP	CMR
BD-315/2	-	1031
BD-315/3	1231	-
BD-355/1	-	1135
BD-355/2	-	-
BD-355/3	1435	-
BD-400/1	1640	-
BD-400/2	-	1240
BD-450/1	1845	-
BD-450/2	-	1445
BD-500/1	2050	-

Aplicable a los modelos

Modelo	CMP	CMR
BD-500/2	-	1650
BD-560	-	1856
BD-630/1	2563	-
BD-630/2	-	2063
BD-710	-	2271
BD-800	-	2380
BD-900/1	-	2590
BD-1000/1	-	28100

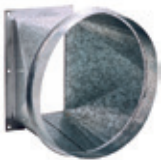

**BIC**

**Brida conversión de rectangular a circular para ventiladores centrífugos**

Características:

- Se adapta a la boca de impulsión
- Facilita la instalación al conducto circular

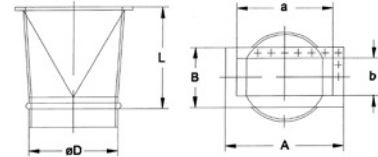

Modelo	L	D	a	b	A	B	Aplicable a modelos
BIC-242	200	100	95	60	155	120	CAS-242
BIC-248	200	112	105	66	165	126	CAS-248
BIC-254	200	125	115	75	175	135	CAS-254
BIC-260	200	150	125	85	185	145	CAS-260
BIC-463	200	200	125	85	185	145	CAS-463
BIC-467	250	224	130	90	190	150	CAS-467
BIC-571	250	250	145	95	205	155	CAS-571
BIC-640	250	250	200	125	260	185	CAS-640
BIC-645	250	250	224	140	284	200	CAS-645
BIC-650	250	250	250	160	310	220	CAS-650
BIC-680	250	180	100	71	160	131	CAS-680
BIC-790	250	180	112	80	172	140	CAS-790
BIC-852	250	280	280	180	340	240	CAS-852
BIC-856	280	355	280	180	340	240	CAS-856
BIC-863	280	355	315	200	375	260	CAS-863
BIC-971	280	400	355	224	425	294	CAS-971
BIC-980	300	250	200	140	270	210	CAS-980
BIC-990	300	280	224	160	294	230	CAS-990
BIC-1080	300	250	200	140	270	210	CAS-1080
BIC-1090	300	280	224	160	294	230	CAS-1090
BIC-1250	450	400	400	280	480	360	CAS-1250/A
BIC-1456	450	450	450	315	530	395	CAS-1456/A
BIC-1663	450	500	500	355	580	435	CAS-1663/A
BIC-1671	450	630	560	400	660	500	CAS-1671/A-2071/A
BIC-2080	450	710	630	450	730	550	CAS-2080/A
BIC-512	300	112	86	75	118	104	CMP-512

Modelo	L	D	a	b	A	B	Aplicable a modelos
BIC-514	300	140	107	83	147	122	CMP-514
BIC-616	300	160	125	103	172	153	CMP-616
BIC-620	300	200	100	105	153	159	CMP-620
BIC-718	300	180	146	115	192	169	CMP-718
BIC-820	300	200	156	160	213	184	CMP-820
BIC-922	300	224	216	140	282	204	CMP-922
BIC-1025	300	250	250	165	314	229	CMP-1025
BIC-1128	300	280	300	180	364	244	CMP-1128
BIC-1231	300	315	320	200	384	266	CMP-1231
BIC-1435	300	355	280	228	344	294	CMP-1435
BIC-1640	300	400	320	250	404	336	CMP-1640
BIC-1845	450	450	360	284	444	370	CMP-1845
BIC-2050	450	500	450	315	545	412	CMP-2050
BIC-2563	450	630	600	410	706	512	CMP-2563
BIC-1031	300	315	315	250	385	320	CMR-1031
BIC-1135	450	355	355	280	425	350	CMR-1135
BIC-1240	450	400	400	315	480	395	CMR-1240
BIC-1445	450	450	450	355	540	445	CMR-1445
BIC-1650	450	500	500	400	590	490	CMR-1650
BIC-1856	450	560	560	450	660	550	CMR-1856
BIC-2063	450	630	630	500	750	620	CMR-2063
BIC-2271	450	710	710	560	840	690	CMR-2271
BIC-2380	600	800	800	560	920	680	CMR-2380
BIC-2590	600	900	900	630	1020	750	CMR-2590
BIC-28100	600	1000	1000	710	1120	830	CMR-28100

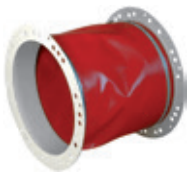

## BAC

Brida de acoplamiento doble y elástica para ventiladores helicoidales

Características:

- Se adapta a la boca de aspiración e impulsión
- Facilita la instalación al conducto con brida
- Evita la transmisión de vibraciones

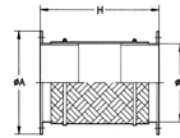

Modelo	HCT	CHT	HT	HPX
BAC-250	25	200/225	25	-
BAC-315/B	31	-	-	-
BAC-315	-	-	31	-
BAC-355	35	250/315	35	35
BAC-400	40	-	40	-
BAC-450	45	-	45	45
BAC-500	50	400/450	50	50

Modelo	HCT	CHT	HT	HPX
BAC-560	56	-	56	56
BAC-630	63	500	63	63
BAC-710	71	560/630	71	71
BAC-800	80	-	80	80
BAC-900	90	-	90	90
BAC-1000	100	-	100	100
BAC-1250	-	-	-	-

	ØD*	ØA*	H
BAC-250	250	310	340
BAC-355	355	430	340
BAC-400	400	480	340
BAC-450	450	530	340
BAC-500	500	590	340
BAC-560	560	650	340
BAC-630	630	720	340
BAC-710	710	800	340
BAC-800	800	890	340
BAC-900	900	1000	340
BAC-1000	1000	1100	340
BAC-1250	1250	1365	340

\*Diámetro nominal tubería



## PS

Conjunto de pies soporte, para ventiladores tubulares.

Características:

- Al fijarse a la brida facilita la fijación sobre superficies planas

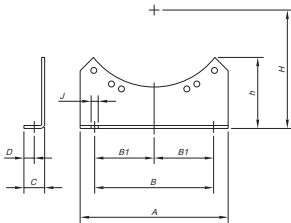

Modelo	A	B	B1	C	D	h	H	ØJ
PS-35/40	240	200	-	40	17	75	270,5	12
PS-45/50	450	400	200	40	17	175	328	12
PS-45/50	450	400	200	40	17	175	355	12
PS-56/63	520	430	215	45	20	242	425	14
PS-56/63	520	430	215	45	20	242	472,5	14
PS-71	620	530	265	50	20	228	530	16
PS-80	730	640	320	60	25	255	590	16
PS-90	780	690	345	70	30	273	650	18
PS-100	860	770	385	75	35	310	730	18
PS-125	1020	920	460	55	25	411	830	13

Modelo	HCT/HBA	HPX/HTP
PS-25/31	25/31	-
PS-35/40	35/40	35
PS-45/50	45/50	45/50
PS-56/63	56/63	56/63
PS-71	71	71
PS-80	80	80
PS-90	90	90
PS-100	100	100



## MS

Marco soporte para facilitar el montaje en obra

Características:

- Utilizado para facilitar el montaje del ventilador en conductos de obra

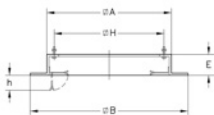

Modelo	ØA	ØB	E	ØH	h
MS-348	348	520	60	295	70
MS-393	393	565	60	320	70
MS-443	443	615	60	360	70
MS-493	493	665	60	410	70
MS-553	553	725	60	450	70

Modelo	ØA	ØB	E	ØH	h
MS-623	623	795	60	530	70
MS-701	701	875	60	590	90
MS-791	791	965	60	680	90
MS-891	891	1065	60	750	90
MS-991	991	1165	60	850	90
MS-1086	1086	1260	60	850	90
MS-1140	1140	1314	60	1000	90
MS-1240	1240	1414	60	1100	90

Modelo	CHT	HT
MS-348	-	-
MS-393	-	-
MS-443	200/225	25
MS-493	-	31
MS-553	250/315	35
MS-623	-	40
MS-701	400/450	45
MS-791	-	50
MS-891	500	56
MS-991	-	63/71
MS-1086	560/630	-
MS-1140	-	80/90
MS-1240	-	100



## PA

Placa de adaptación para montaje de accesorios, en extractores de tejado

Características:

- Se utiliza para el montaje de los accesorios PT, B, BTUB, BAC. Permite separar el ventilador de su base sin desmontar el conjunto de accesorios

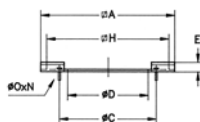

Modelo	ØA	ØJ	ØD	E	ØH	ØO	N
PA-345	345	200	165	20	245	M.8	4x90°
PA-390	390	210	190	20	320	M.8	4x90°
PA-440/250	440	280	249	20	360	M.6	4x90°
PA-490	490	355	314	20	410	M.8	8x45°
PA-550	550	395	354	20	450	M.6	8x45°
PA-620	620	450	399	20	530	M.10	8x45°
PA-700/500	700	560	499	20	590	M.10	12x30°
PA-700/450	700	500	449	20	590	M.10	8x45°

Modelo	ØA	ØJ	ØD	E	ØH	ØO	N
PA-790	790	560	499	20	680	M.10	12x30°
PA-890/630	890	690	629	20	750	M.10	12x30°
PA-890/560	890	620	559	20	750	M.10	12x30°
PA-990/630	990	690	629	20	850	M.10	12x30°
PA-990/710	990	770	709	20	850	M.10	16x22°30'
PA-1085	1085	770	709	20	850	M.10	16x22°30'
PA-1138/800	1138	860	799	25	1000	M.10	16x22°30'
PA-1138/900	1138	970	899	25	1000	M.12	16x22°30'
PA-1238	1238	1070	999	25	1100	M.12	16x22°30'

Modelo	CHT	HT
PA-440/250	200/225	25
PA-490	-	31
PA-550	250/315	35
PA-620	-	40
PA-700/500	400/450	-
PA-700/450	-	45
PA-790	-	50
PA-890/630	500	-
PA-890/560	-	56
PA-990/630	-	63
PA-990/710	-	71
PA-1085	560/630	-
PA-1138/800	-	80
PA-1138/900	-	90
PA-1238	-	100



## PT Obturadores de cierre automático para trabajo vertical

Características:

- Obturadores circulares de cierre automático para ser instalados en la aspiración de extractores de tejado
- Aconsejable utilizar la placa de adaptación PA, para su montaje

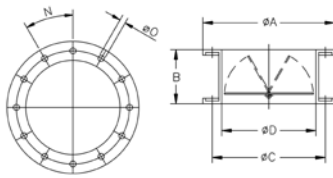

Modelo	ØA	B	ØC	ØD*	ØO	N	Aplicable a los modelos	
							CHT/CVT	CHRE
PT-160	220	150	200	160	10	4x90°	-	722
PT-180	240	150	210	180	10	4x90°	-	825
PT-250	310	150	280	250	10	4x90°	200/225	1131
PT-355	435	200	395	355	10	8x45°	250/315	1135/1240
PT-500	600	280	560	500	12	12x30°	400/450	1445/1650
PT-630	730	355	690	630	12	12x30°	500	-
PT-710	810	400	770	710	12	16x22°30'	560/630	-

\*Diámetro nominal tubería



## OP Obturadores de sobrepresión para extractores de tejado

OP-25	HT-25	OP-40	HT-40	OP-56	HT-56	OP-80	HT-80
OP-31	HT-31	OP-45	HT-45	OP-63	HT-63	OP-90	HT-90
OP-35	HT-35	OP-50	HT-50	OP-71	HT-71	OP-100	HT-100



## ACE/ATEX Acoplamiento elástico para amortiguar vibraciones

Características:

- Se utiliza entre la boca del ventilador y el conducto para evitar la transmisión de vibraciones

	Aplicable a los modelos (ASPIRACIÓN)					Aplicable a los modelos (IMPULSIÓN)	
	CMA	CAS	CA	CMP	CMR	CA	CMA
ACE-52	-	-	-	-	-	234	-
ACE-63	-	-	-	-	-	142	218/324
ACE-80	218/324	-	-	-	-	148/154/160/166	325
ACE-100	325	242	234/142	-	-	172	426/527
ACE-112	426	248	148	512	-	-	-
ACE-125	527/528	254	154	-	-	-	528
ACE-140	-	-	-	514	-	-	-
ACE-150	531	260	160	-	-	531/540	-
ACE-160	-	680	-	616	-	-	-
ACE-180	540/545	790	166/172	718	-	-	545
ACE-200	-	463	-	620/820	-	-	-
ACE-224	-	467	-	922	-	-	-
ACE-250	-	-	-	1025	-	-	-
ACE-280	-	571/640/645 650/980/1080	-	1128	-	-	-
ACE-315	-	852/990/1090	-	1231	1031	-	-
ACE-355	-	-	-	1435	1135	-	-
ACE-400	-	856/963/1250/A	-	1640	1240	-	-
ACE-450	-	971/1456/A	-	1845	1445	-	-
ACE-500	-	-	-	2050	1650	-	-
ACE-560	-	1663/A	-	-	1856	-	-
ACE-630	-	1671/A-2071/A	-	2563	2063	-	-
ACE-710	-	2080/A	-	-	2271	-	-
ACE-800	-	-	-	-	2380	-	-
ACE-900	-	-	-	-	2590	-	-
ACE-1000	-	-	-	-	28100	-	-



## REG Registro de regulación manual

Características:

- Su construcción permite incorporarlos en los sistemas de conductos, para la regulación del caudal

Modelo	L	ØD*	Modelo	L	ØD*
REG-80	100	80	REG-250	100	250
REG-100	100	100	REG-280	100	280
REG-112	100	112	REG-315	100	315
REG-125	100	125	REG-355	100	355
REG-140	100	140	REG-400	100	400
REG-150	100	150	REG-450	150	450
REG-160	100	160	REG-500	150	500
REG-180	100	180	REG-560	150	560
REG-200	100	200	REG-630	250	630
REG-224	100	224	REG-800	250	800



## CJACUS Cajas acústicas para ventiladores centrífugos

Características:

- Caja de ventilación construida en chapa galvanizada con aislamiento acústico
- Pies soporte y silent-blocks incluidos
- CJACUS/C: Con conexión de aspiración e impulsión al exterior, por medio de conductos. Rejilla para la refrigeración del motor incluida
- CJACUS/L: Con aspiración libre por medio de rejilla, incorporada en la caja y conexión de impulsión al exterior

Aplicable a los modelos

Modelo	CAS	CA
CJACUS-0	640	154
CJACUS-1	254/645	160
CJACUS-2	260/463/650	166
CJACUS-3	467/852/856	172
CJACUS-4	571/863	-
CJACUS-5	971	-



## S Silenciadores para acoplar a la aspiración o impulsión.

Características:

- Silenciadores circulares o rectangulares para acoplar a la aspiración o impulsión, de ventiladores centrífugos o helicoidales

ASPIRACIÓN / IMPULSIÓN (Sección rectangular)

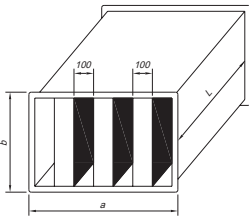

	L	a	b	Kg	Amortiguación de sustitución (dB) en banda de octavos (Hz)						Aplicable
					125	250	500	1000	2000	4000	
SR-1000/900/900	900	1000	900	64	4	10	21	37	44	37	HCH/HCT
SR-1200/900/900	900	1200	900	74	4	10	21	37	44	37	HCH/HCT
SR-1400/1200/900	900	1400	1200	102	4	12	25	41	47	42	HCH/HCT
SR-1800/1200/1200	1200	1800	1200	169	4	12	25	41	47	42	HCH/HCT
SR-1800/1500/1200	1200	1800	1504	195	4	12	25	41	47	42	HCH/HCT

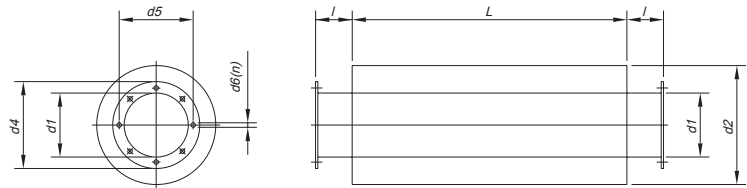

ASPIRACIÓN / IMPULSIÓN (Sección circular)

	L	d1	d2	l	d3	d4	d5	d6	n	Kg	Amortiguación de sustitución (dB) en banda de octavos (Hz)						Aplicable
											125	250	500	1000	2000	4000	
SC-630/900	900	630	800	100	630	720	690	12	12x30°	44	5	8	14	12	13	9	HCH/HCT
SC-710/900	900	710	900	100	710	800	770	12	16x22°30'	65	5	8	13	11	12	8	HCH/HCT
SC-800/900	900	800	1000	100	800	900	860	12	16x22°30'	70	4	8	11	9	9	8	HCH/HCT
SC-900/1200	1200	900	1120	100	900	1000	970	15	16x22°30'	87	5	7	11	11	7	5	HCH/HCT
SC-1000/1200	1200	1000	1200	100	1000	1100	1070	15	16x22°30'	95	4	7	11	10	7	6	HCH/HCT

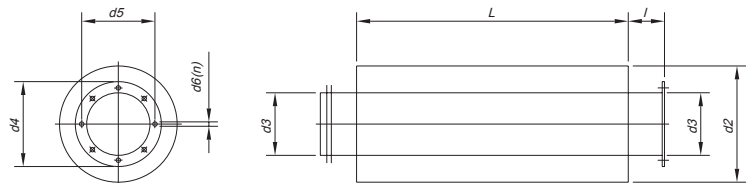

	L	d2	d3	d4	d5	d6	n	Kg	Amortiguación de sustitución (dB) en banda de octavos (Hz)						Aplicable	
									125	250	500	1000	2000	4000		
S-250/600-A	600	450	250	310	280	10	4x90°	14	5	12	20	24	23	14	CVT-CHT-200/225 / HT-25	
S-315/900-A	900	500	315	390	355	10	8x45°	22	4	12	21	26	19	15	HT-31	
S-355/900-A	900	560	355	430	395	10	8x45°	25	4	12	20	24	18	14	CVT-CHT-250/315 / HT-35	
S-400/900-A	900	600	400	480	450	12	8x45°	29	5	12	19	22	18	13	HT-40	
S-450/900-A	900	630	450	530	500	12	8x45°	32	5	12	18	20	16	12	HT-45	
S-500/900-A	900	710	500	590	560	12	12x30°	35	4	11	18	16	14	11	CVT-CHT-400/450 / HT-50	
S-560/900-A	900	750	560	650	620	12	12x30°	41	4	10	16	14	13	10	HT-56	
S-630/900-A	900	800	630	720	690	12	12x30°	44	5	8	14	12	13	9	CVT-CHT-500 / HT-63	
S-710/900-A	900	900	710	800	770	12	16x22°30'	65	5	8	13	11	12	8	CVT-CHT-560/630 / HT-71	
S-800/900-A	900	1000	800	900	860	12	16x22°30'	70	4	8	11	9	9	8	HT-80	
S-900/1200-A	1200	1120	900	1000	970	12	16x22°30'	85	5	7	11	11	7	6	HT-90	
S-1000/1200-A	1200	1200	1000	1100	1070	12	16x22°30'	95	4	7	11	10	7	6	HT-100	

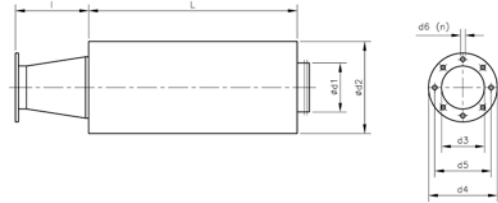

## ASPIRACIÓN

	L	d1	d2	l	d3	d4	d5	d6	n	Kg	Amortiguación de sustitución (dB) en banda de octavos (Hz)						Aplicable
											125	250	500	1000	2000	4000	
S-80/600/218-A	600	80	280	103	80	113	95	6	4x90°	6	17	26	29	53	53	45	CMA-218
S-100/600/324-A	600	100	300	108	80	130	112	6	4x90°	8	13	23	34	46	52	40	CMA-324
S-125/600/325-A	600	125	315	114	94	140	122	7	4x90°	8	11	20	30	40	45	30	CMA-325
S-150/600/426-A	600	150	355	132	117	155	132	7	4x90°	9	10	19	29	37	42	25	CMA-426
S-150/600/527-A	600	150	355	114	125	170	147	7	4x90°	9	10	19	29	37	42	25	CMA-527
S-160/600/528-A	600	160	355	107	135	190	162	7	4x90°	9	9	16	28	33	37	21	CMA-528
S-200/600/531-A	600	200	400	135	160	215	180	7	4x90°	12	6	12	22	28	28	18	CMA-531
S-250/600/540-A	600	250	450	204	170	240	205	11	4x90°	14	5	12	20	24	23	14	CMA-540
S-315/900/545-A	900	315	500	266	180	255	220	11	4x90°	22	4	12	21	26	19	15	CMA-545
S-100/600/242-A	600	100	300	115	100	150	130	10	8x45°	8	13	23	34	46	52	40	CAS-242
S-150/900/248-A	900	150	355	200	112	160	140	10	8x45°	11	10	27	37	51	53	37	CAS-248
S-160/900/254-A	900	160	355	200	125	180	155	10	8x45°	12	11	24	35	49	51	27	CAS-254
S-200/900/260-A	900	200	400	200	150	210	175	10	8x45°	17	8	18	28	40	37	23	CAS-260
S-200/900/463-A	900	200	400	200	200	260	240	10	8x45°	17	8	18	28	40	37	23	CAS-463
S-250/900/467-A	900	250	450	200	224	280	258	10	8x45°	22	6	17	30	34	28	17	CAS-467
S-250/900/571-A	900	250	450	200	250	310	275	10	8x45°	22	6	17	30	34	28	17	CAS-571
S-250/600/640-A	600	250	450	200	250	310	275	10	8x45°	14	5	12	20	24	23	14	CAS-640
S-315/900/645-A	900	315	500	200	250	310	275	10	8x45°	22	4	12	21	26	19	15	CAS-645
S-355/900/650-A	900	355	560	200	250	310	275	10	8x45°	25	4	12	20	24	18	14	CAS-650
S-180/900/680-A	900	180	380	100	165	235	200	11	8x45°	14	9	21	31	44	44	25	CAS-680
S-180/900/790-A	900	180	380	100	185	235	219	11	8x45°	14	9	21	31	44	44	25	CAS-790
S-355/900/852-A	900	355	560	200	280	350	310	10	8x45°	25	4	12	20	24	18	14	CAS-852
S-400/1200/856-A	1200	400	600	200	355	430	395	10	8x45°	38	7	16	22	29	22	15	CAS-856
S-400/1200/863-A	1200	400	600	200	355	430	410	10	8x45°	38	7	16	22	29	22	15	CAS-863
S-450/1200/971-A	1200	450	630	200	400	480	450	12	8x45°	42	6	15	21	25	20	14	CAS-971
S-250-1200/980-A	1200	250	450	100	255	325	292	11	8x45°	28	9	22	35	39	33	20	CAS-980
S-280/1200/990-A	1200	280	450	100	286	366	332	11	8x45°	32	8	18	31	38	28	19	CAS-990
S-250/1200/1080-A	1200	250	450	100	255	325	292	11	8x45°	28	9	22	35	39	33	20	CAS-1080
S-280/1200/1090-A	1200	280	450	100	286	366	332	11	8x45°	32	8	18	31	38	28	19	CAS-1090
S-500/900/1250-A	900	500	710	300	361	441	405	11,5	8x45°	56	6	13	18	15	15	12	CAS-1250/A
S-560/900/1456-A	900	560	750	450	406	486	448	11,5	12x30°	65	5	8	13	11	12	8	CAS-1456/A
S-630/1200/1663-A	1200	630	800	450	568	668	629	11,5	16x22°30'	70	4	8	11	9	8	8	CAS-1663/A
S-80/600/234-A	600	80	280	108	98	130	115	5	6x60°	6	17	26	29	53	53	45	CA-234
S-100/600/142-A	600	100	300	108	90	160	130	9	4x90°	8	13	23	34	46	52	40	CA-142
S-150/900/148-A	900	150	355	149	100	170	140	9	4x90°	11	10	27	37	51	53	37	CA-148
S-160/900/154-A	900	160	355	146	115	183	155	11	4x90°	12	11	24	35	49	51	27	CA-154
S-200/900/160-A	900	200	400	183	130	230	192	11	4x90°	17	8	18	28	40	37	23	CA-160
S-200/900/166-A	900	200	400	162	140	230	200	11	4x90°	17	8	18	28	40	37	23	CA-166
S-200/900/172-A	900	200	400	149	148	230	200	11	4x90°	17	8	18	28	40	37	23	CA-172
S-315/600/922-A	600	315	500	238	220	278	256	9	8x45°	16	4	8	14	17	14	12	CMP-922
S-355/900/1025-A	900	355	560	224	245	305	282	9	8x45°	25	4	12	20	24	23	14	CMP-1025
S-400/900/1128-A	900	400	600	250	270	348	320	9	8x45°	29	5	12	19	22	18	13	CMP-1128
S-450/900/1231-A	900	450	630	291	295	382	354	9	8x45°	32	5	12	18	20	16	12	CMP-1231
S-500/900/1435-A	900	500	710	284	345	422	394	9	8x45°	35	4	11	18	16	14	11	CMP-1435
S-500/900/1640-A	900	500	710	227	395	464	438	9	8x45°	35	4	11	18	16	14	11	CMP-1640
S-560/900/1845-A	900	560	750	241	445	515	485	9	8x45°	41	4	10	16	14	13	10	CMP-1845
S-630/1200/2050-A	1200	630	800	269	495	565	535	11	8x45°	56	6	13	18	15	15	12	CMP-2050
S-800/1200/2563-A	1200	800	1000	370	595	710	675	14	8x45°	80	5	9	13	11	11	9	CMP-2563
S-400/900/1031-A	900	400	600	202	320	383	356	9	8x45°	29	5	12	19	22	18	13	CMR-1031
S-450/900/1135-A	900	450	630	216	345	425	398	9	8x45°	32	5	12	18	20	16	12	CMR-1135
S-500/900/1240-A	900	500	710	227	395	472	444	11	8x45°	35	4	11	18	16	14	11	CMR-1240
S-560/900/1445-A	900	560	750	241	445	522	494	11	8x45°	41	4	10	16	14	13	10	CMR-1445
S-630/1200/1650-A	1200	630	800	269	495	582	555	11	8x45°	56	6	13	18	15	15	12	CMR-1650
S-710/900/1856-A	900	710	900	301	555	645	615	11	8x45°	65	5	8	13	11	12	8	CMR-1856
S-800/900/2063-A	900	800	1000	329	625	720	688	11	8x45°	70	4	8	11	9	9	8	CMR-2063
S-800/1200/2271-A	1200	800	1000	224	705	800	768	13	8x45°	80	5	9	13	11	11	9	CMR-2271

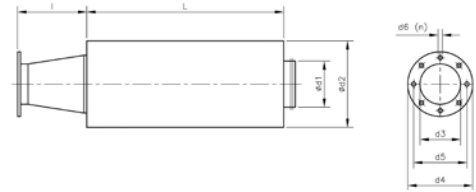

IMPULSIÓN (Brida circular)

	L	d1	d2	l	d3	d4	d5	d6	n	Kg	Amortiguación de sustitución (dB) en banda de octavos (Hz)						
											125	250	500	1000	2000	4000	Aplicable
S-80/600/234-I	600	80	280	103	40	100	72	9	2x180°	6	17	26	29	53	53	45	CAS-234
S-100/600/142-I	600	100	300	131	60	120	90	11	4x90°	8	13	23	34	46	52	40	CAS-142
S-150/900/148-I	900	150	355	176	73	150	110	11	4x90°	11	10	27	37	51	53	37	CAS-148
S-160/900/154-I	900	160	355	190	80	160	120	13	4x90°	12	11	24	35	49	51	27	CAS-154
S-200/900/160-I	900	200	400	245	85	160	120	13	4x90°	17	8	18	28	40	37	23	CAS-160
S-200/900/166-I	900	200	400	245	85	160	120	13	4x90°	17	8	18	28	40	37	23	CAS-166
S-200/900/172-I	900	200	400	245	90	175	140	13	4x90°	17	8	18	28	40	37	23	CAS-172

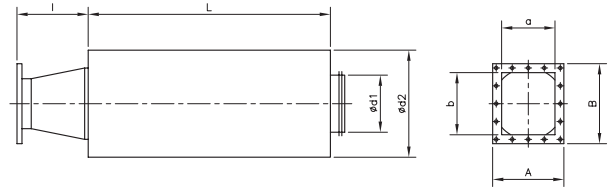

IMPULSIÓN (Brida rectangular)

	L	d1	d2	l	a	b	A	B	Kg	Amortiguación de sustitución (dB) en banda de octavos (Hz)						
										125	250	500	1000	2000	4000	Aplicable
S-100/600/242-I		100	300	200	95	60	155	120	8	13	23	34	46	52	40	CAS-242
S-150/900/248-I	600	150	355	200	105	66	165	126	11	10	27	37	51	53	37	CAS-248
S-160/900/254-I	900	160	355	200	115	75	175	135	12	11	24	35	49	51	27	CAS-254
S-200/900/260-I	900	200	400	200	125	85	185	145	17	8	18	28	40	37	23	CAS-260
S-200/900/463-I	900	200	400	200	125	85	185	145	17	8	18	28	40	37	23	CAS-463
S-250/900/467-I	900	250	450	250	130	90	190	150	22	6	17	30	34	28	17	CAS-467
S-250/900/571-I	900	250	450	250	145	95	205	155	22	6	17	30	34	28	17	CAS-571
S-250/900/640-I	900	250	450	250	200	125	260	185	14	5	12	20	24	23	14	CAS-640
S-315/900/645-I	600	315	500	250	224	140	284	200	22	4	12	21	26	19	15	CAS-645
S-355/900/650-I	900	355	560	250	250	160	310	220	25	4	12	20	24	18	14	CAS-650
S-180/900/680-I	900	180	380	100	71	100	131	160	15	9	21	31	44	44	25	CAS-680
S-180/900/790-I	600	180	380	100	80	112	140	172	15	9	21	31	44	44	25	CAS-790
S-355/900/852-I	600	355	560	250	280	180	340	240	25	4	12	20	24	18	14	CAS-852
S-400/1200/856-I	900	400	600	280	280	180	340	240	38	7	16	22	29	22	15	CAS-856
S-400/1200/863-I	1200	400	600	280	315	200	375	260	38	7	16	22	29	22	15	CAS-863
S-450/1200/971-I	1200	450	630	280	355	224	425	294	42	6	15	21	25	20	14	CAS-971
S-250/1200/980-I	1200	250	450	100	140	200	210	270	29	9	22	35	39	33	20	CAS-980
S-280/1200/990-I	1200	280	450	100	160	224	230	294	33	8	18	31	38	28	19	CAS-990
S-250/1200/1080-I	1200	250	450	100	140	200	210	270	29	9	22	35	39	33	20	CAS-1080
S-280/1200/1090-I	1200	280	450	100	160	224	230	294	33	8	18	31	38	28	19	CAS-1090
S-500/900/1250-I	1200	500	600	300	280	400	360	480	9	6	13	18	15	15	12	CAS-1250/A
S-560/900/1456-I	900	560	630	450	315	450	395	530	9	5	8	13	11	12	8	CAS-1456/A
S-630/1200/1663-I	900	630	750	450	355	500	435	580	12	4	8	13	11	11	9	CAS-1663/A
S-315/600/922-I	600	315	500	300	216	140	282	204	16	4	8	14	17	14	12	CMP-922
S-355/900/1025-I	900	355	560	300	250	165	314	229	25	4	12	20	24	23	14	CMP-1025
S-400/900/1128-I	900	400	600	300	300	180	364	244	29	5	12	19	22	18	13	CMP-1128
S-450/900/1231-I	900	450	630	300	320	200	384	266	32	5	12	18	20	16	12	CMP-1231
S-500/900/1435-I	900	500	710	300	280	228	344	294	35	4	11	18	16	14	11	CMP-1435
S-500/900/1640-I	900	500	710	300	320	250	404	336	35	4	11	18	16	14	11	CMP-1640
S-560/900/1845-I	900	560	750	450	360	284	444	370	41	4	10	16	14	13	10	CMP-1845
S-630/1200/2050-I	1200	630	800	450	450	315	545	412	56	6	13	18	15	15	12	CMP-2050
S-800/1200/2563-I	1200	800	1000	450	600	410	706	512	80	5	9	13	11	11	9	CMP-2563
S-400/900/1031-I	900	400	600	300	315	250	385	320	29	5	12	19	22	18	13	CMR-1031
S-450/900/1135-I	900	450	630	450	355	280	425	350	32	5	12	18	20	16	12	CMR-1135
S-500/900/1240-I	900	500	710	450	400	315	480	395	35	4	11	18	16	14	11	CMR-1240
S-560/900/1445-I	900	560	750	450	450	355	540	445	41	4	10	16	14	13	10	CMR-1445
S-630/1200/1650-I	1200	630	800	450	500	400	590	490	56	6	13	18	15	15	12	CMR-1650
S-710/900/1856-I	900	710	900	450	560	450	660	550	65	5	8	13	11	12	8	CMR-1856
S-800/900/2063-I	900	800	1000	450	630	500	750	620	70	4	8	11	9	9	8	CMR-2063
S-800/1200/2271-I	1200	800	1000	450	710	560	840	690	80	5	9	13	11	11	9	CMR-2271
S-800/1201/2380-I	1200	800	1000	450	560	800	680	920	90	5	9	13	11	11	9	CMR-2380

## Sensores inteligentes para el control de la ventilación



Sensores que permiten captar ciertas condiciones ambientales y accionar automáticamente los ventiladores. Ello permite utilizar la ventilación sólo cuando es necesaria. Utilizando los sensores con los variadores de frecuencia podremos controlar el régimen de funcionamiento de los ventiladores, evitando así, que el ventilador siempre funcione al máximo de su consumo. Estos sistemas tienen como resultado un importante ahorro energético.



SI-PIR-TF-Cenital



SI-PIR-TF-Mural

### SI-PIR

#### Detector de presencia

Activa automáticamente el sistema de ventilación cuando detecta la presencia de personas en su radio de acción y se mantiene en funcionamiento por un tiempo prefijado, regulable mediante reloj interno

Modelo	Alimentación	Salida	Ángulo detección	Reglajes	Altura instalación	Temperatura de utilización
SI-PIR	230V	230V	360°C	Temporización 5s-30 min	2,4-4,2 m	-20° +50° C
SI-PIR-TFT-550-B	24V ac/24V dc	24V ac/24V dc	110°C	Temporización 5s-30 min	1,8-3,6 m	-20° +50° C
SI-PIR-TF-25-360	24V ac/24V dc	24V ac/24V dc	360°C	Temporización 10s-30 min	2,4-4,2 m	-20° +50° C



### SI-SMOKE

#### Detector de humo de tabaco

Activa automáticamente el sistema de ventilación cuando el humo de tabaco y otros contaminantes, exceden del valor prefijado en el sensor, y se mantiene en funcionamiento por un tiempo prefijado, regulable mediante reloj interno

Modelo	Alimentación	Salida	Intensidad máx (A)	Reglajes	Altura instalación	Temperatura de utilización
SI-SMOKE	220-240V ac	220-240V ac	3,0	Temporización 3min-20 min	1,5-2,0 m	-20° +50° C



### SI-CO2

#### Detector de calidad de aire

Activa automáticamente el sistema de ventilación cuando el incremento de la contaminación, en función de la ocupación del local, excede del valor prefijado

Modelo	Alimentación	Salida	Consumo (W)	Reglajes	Altura instalación	Temperatura de utilización
SI-CO2-GAQ24	24V ac	0-10V ac	5	Temporización 10s-30 min	1,5-2,5 m	-20° +50° C



### SI-CO2 IND

Sensor de concentración de Co2

Modelo	Alimentación	Salida	Consumo máximo (VA)	Rango concentración CO2	Temperatura de utilización
SI-CO2 IND/P	15-24V ac ±10 %/18-34V dc	0-10V dc/0-20mA	2,5	0-2000 ppm	-10 +50 °C
SI-CO2 IND/C	15-24V ac ±10 %/18-34V dc	0-10V dc/0-20mA	2,5	0-2000 ppm	0 +50 °C



## SI-TEMP

### Sensor de temperatura

Activa automáticamente el sistema de ventilación cuando detecta una temperatura superior al punto de consigna. Una vez la temperatura ambiente ha descendido por debajo del punto de consigna, el ventilador permanece en funcionamiento por un tiempo prefijado, regulable mediante reloj interno. El rango de temperatura oscila entre +10°C a 40°C

Modelo	Alimentación	Salida	Intensidad máx (A)	Reglajes	Altura instalación	Temperatura de utilización
SI-TEMP	220-240V ac	220-240V ac	3,0	Temporización 3min-20 min	1,5-2,0 m	+10° +40° C



## SI TEMP IND

Sensor de temperatura proporcional

Modelo	Alimentación	Salida	Consumo máximo (VA)	Temperatura de utilización
SI-TEMP IND/P	15-24V ac ±10 %/18-34V dc	0-10V dc/0-20mA	1,5	0 +50 °C



## SI-TEMP+HUMEDAD

### Sensor de temperatura y humedad relativa con display

Controla independientemente la temperatura y la humedad relativa del aire ambiente del local. Activa automáticamente el sistema de ventilación cuando detecta una temperatura o humedad superior al punto de consigna. Una vez la temperatura o humedad ambiente ha descendido por debajo del punto de consigna, el ventilador permanece en funcionamiento por un tiempo prefijado, regulable mediante reloj interno

Modelo	Alimentación	Salida	Reglajes	Altura instalación	Temperatura de utilización
SI-TEMP+HUMEDAD	24V ac	0-10V dc	$\Delta T = 0,5^{\circ}\text{C}$ y $\Delta \text{HR} = 2\%$	1,5-2,5 m	+10° +40° C



## SI-HUMIDOSTATO

Sensor humedad

Modelo	Alimentación	Salida	Consumo máximo (VA)	Rango Humedad relativa	Temperatura de utilización
SI-HUMIDOSTATO	15-24V ac ±10 %/18-34V dc	220-240V ac	2	0-100 % RH	0 +50 °C



## SI-HUMEDAD

Sensor humedad proporcional

Modelo	Alimentación	Salida	Consumo máximo (VA)	Rango Humedad relativa	Temperatura de utilización
SI-HUMEDAD	15-24V ac ±10 %/18-34V dc	0-10V dc/0-20mA	2,5	0-100 % RH	0 +50 °C





## SI-PRESIÓN

### Transmisor de presión

Controla la presión en instalaciones de ventilación en presión constante, y la transforma en una señal eléctrica, para regular el sistema de ventilación y mantener siempre la misma presión

Modelo	Alimentación	Salida	Consumo máximo (VA)	Conectores	Rango de presión
SI-PRESIÓN TPDA	24V ac/24V dc	0-10V/4-20mA	4	6,2 mm	0-2500 Pa
SI-PRESIÓN TPDA c/DISPLAY	24V ac/24V dc	0-10V/4-20mA	4	6,2 mm	0-2500 Pa



## SI-TIMER

### Temporizador

Ajusta el tiempo de funcionamiento del sistema de ventilación al cual está conectado. El sistema de ventilación se activa automáticamente con el encendido del interruptor de la luz y continua funcionando por un tiempo prefijado regulable mediante reloj interno

Modelo	Alimentación	Salida	Intensidad máx (A)	Reglajes	Temperatura de utilización
SI-TIMER	220-240V ac	220-240V dc	3,0	Temporización 3min-20 min	-20° +50° C



SI-FUENTE DE ALIMENTACIÓN ac



SI-FUENTE DE ALIMENTACIÓN dc

## SI-FUENTE DE ALIMENTACIÓN

### Fuente de alimentación 24V dc/ac

Alimenta los sensores inteligentes de 24V dc/ac, a partir de una entrada de tensión de 230V. monofásica

Modelo	Alimentación	Salida	Potencia (VA)
SI-FUENTE DE ALIMENTACIÓN dc	230 V	24V dc	30
SI-FUENTE DE ALIMENTACIÓN ac	230/400 V	24/48V ac	25



## CENTRAL CO

Centrales de detección de monóxido, para el control de la ventilación en aparcamientos

Modelo	Aplicación
FMC-C-501	Central para 1 zona
FMC-C-502	Central para 2 zona
FMC-C-503	Central para 3 zona
FM-M-509	Módulo ampliación de zona
FM-DP500	Detector de CO de pared
FM-D500	Detector de CO de techo
FM-TC500	Tarjeta control por variador

## Índice Alfabético de Referencias. VENTILADORES

CA/ATEX	176	CMRH	67	HFW	72
CAB	26	CMRS	14	HGT	97
CAS/ATEX	171	CMRS-X	31	HGTX	97
CASB	20	CPV	62	HPX/ATEX	149
CASB-X	39	CPV/ATEX	152	HPX/SEC	95
CHT/ATEX	186	CVT/ATEX	186	HT/ATEX	179
CMA/ATEX	155	HBA	93	HTM/ATEX	147
CMP/AL	166	HC/ATEX	134	HTMH	122
CJMP/AL	166	HCDF	131	HTP	77
CMP/ATEX	158	HCH/ATEX	140	KIT SOBREPRESIÓN	190
CMP/MAR	48	HCT/ATEX	140	RFHD	182
CMPI	52	HCT/MAR	119		
CMR/ATEX	168	HDF	131		
CMRG	56	HFT/MAR	119		

## Índice Alfabético de Referencias. ACCESORIOS

ACE/ATEX	203	INT	195	R	198
AR	195	Interruptor ATEX	195	REG	203
B	200	KME-10K	197	RI	199
BAC	202	MS	202	RPA	199
BD	201	OP	203	RT	199
BIC	201	P	198	S	204
BTUB	199	PA	202	SENSORES INTELIGENTES	207
CJACUS	204	PL	198	VSD1/A-RFM	196
CUADROS ELÉCTRICOS	197	PS	202	VSD3/A-RFT	196
GMM	197	PT	203		
GMP	197	PV	199		





EFFICIENT WORK FANS



# SOLution DEVELOPMENT CAPacity

Fast and flexible industrial fan solutions and tailored fans  
 Large experience in smoke control systems and ATEX applications  
 Wide range of certified products for specific markets

VENTILADORES  
 HELICOIDALES Y  
 EXTRACTORES DE TEJADO



VENTILADORES  
 CENTRÍFUGOS Y EXTRACTORES  
 EN LÍNEA



EXTRACTORES  
 PARA EVACUACIÓN  
 DE HUMOS



EXTRACTORES PARA  
 ATMÓSFERAS EXPLOSIVAS ATEX  
 Y OTRAS APLICACIONES



**Solicítenos  
 información**

RECUPERADORES DE  
 CALOR Y UNIDADES DE  
 FILTRACIÓN



CORTINAS DE AIRE PARA  
 APLICACIONES COMERCIALES  
 E INDUSTRIALES



SISTEMAS DE  
 VENTILACIÓN PARA  
 VIVIENDAS



Crta. de Berga, km 0.7  
 E-08580 St. Quirze de Besora  
 BARCELONA (Spain)  
 Tel. +34 93 852 91 11  
 Fax. +34 93 852 90 42

comercial@sodeca.com  
**Export sales:** ventilacion@sodeca.com  
**www.sodeca.com**





## HEADQUARTER

**Sodeca, S.L.U.**  
Pol. Ind. La Barricona  
Carrer del Metall, 2  
E-17500 Ripoll  
Girona, SPAIN  
Tel. +34 93 852 91 11  
Fax: +34 93 852 90 42  
General sales:  
comercial@sodeca.com  
Export sales:  
ventilation@sodeca.com

## PRODUCTION PLANT

**Sodeca, S.L.U.**  
Ctra. de Berga, km 0,7  
E-08580 Sant Quirze de  
Besora  
Barcelona, SPAIN  
Tel. +34 93 852 91 11  
Fax: +34 93 852 90 42  
General sales:  
comercial@sodeca.com  
Export sales:  
ventilation@sodeca.com

## RED COMERCIAL ESPAÑA

**Barcelona**  
Sr. Jesús Cuadras  
Pol. Ind. La Barricona  
Carrer del Metall, 2  
E-17500 Ripoll  
Girona, SPAIN  
Tel. +34 93 852 91 11  
Móvil: 639 077 346  
jcuadras@sodeca.com  
Provincias: Barcelona,  
Tarragona, Lleida y Girona

**Baleares**  
Sr. Miquel Àngel Morán  
Móvil: 682 912 100  
baleares@sodeca.com  
Provincias: Baleares

**Bilbao**  
Pitalven S.L.  
Sr. Jon Garin  
Pza. Jaro de Arana, 3 4º  
48012 Bilbao  
Tel./Fax 94 421 42 23  
Móvil: 615 749 646  
jgarin@sodeca.com  
Provincias: Vizcaya,  
Guipúzcoa, Álava,  
Santander, Navarra y Rioja

**Canarias**  
Srta. Ana Terrones  
Móvil: 676 340 543  
canarias@sodeca.com  
Provincias: Islas Canarias

**A Coruña**  
Sr. Ricard Fernández  
Rúa a Granxa, 2B (Lorbe)  
15177 Oleiros  
Tel./Fax 98 162 81 96  
Móvil: 615 145 104  
rfernandez@sodeca.com  
Provincias: A Coruña,  
Lugo, Ourense y  
Pontevedra

**Oviedo**  
Sr. Salvador Nuñez  
Tel. 93 852 91 11  
Móvil: 689 804 734  
asturias@sodeca.com  
Provincias: Asturias y León

**Madrid**  
Sr. José María de Bernardo  
Pol.Ind. Miralcampo  
Calle Aluminio, 12  
19200 Azuqueca de  
Henares  
Tel. 91 366 70 45 /  
91 366 60 45  
Móvil: 670 744 420  
sodecacentro@sodeca.com  
Provincias: Madrid, Toledo,  
Ciudad Real, Guadalajara,  
Segovia, Ávila y Cuenca

**Murcia**  
Sr. Francisco José Hurtado  
Apartado de Correos 6103  
30080 Murcia  
Tel. 675 767 025  
hurtado@sodeca.com  
Provincias: Murcia,  
Almería, Granada y Jaén

**Sevilla**  
Sr. Manuel Zambrano  
Pol.Ind. Los Llanos  
Calle Extremadura, 169 F  
41909 Salteras  
Sevilla  
Móvil: 606 663 814  
mzambrano@sodeca.com  
sevilla@sodeca.com  
Provincias: Sevilla, Huelva,  
Cádiz, Córdoba, Málaga,  
Cáceres y Badajoz

**Valencia**  
Tacier S.L.  
Sr. Javier Talens  
Timoneda, 8, 1º  
46008 Valencia  
Tel. 96 384 14 80  
Fax 96 382 02 07  
Móvil: 670 696 289  
javiertalens@sodeca.com  
csebastian@sodeca.com  
Provincias: Valencia,  
Castellón, Alicante y  
Albacete

**Valladolid**  
Sr. Xavier Formentí  
Tel. 93 852 91 11  
Móvil: 679 559 099  
sodecacastilla@sodeca.com  
Provincias: Salamanca,  
Valladolid, Palencia,  
Burgos y Zamora

**Zaragoza**  
Hernández Silbe S.L.  
Srta. Silvia Hernández  
Alfonso I, casa 15  
50410 Cuarte de Huerva  
Zaragoza  
Tel. 630 263 224  
Fax 97 693 74 30  
sodecaragon@sodeca.com  
Provincias: Huesca,  
Zaragoza, Teruel y Soria



## EUROPE

**FINLAND**  
**Sodeca Finland, Oy**  
HUITTINEN  
Sales and Warehouse  
Mr. Kai Yli-Sipilä  
Metsälinnankatu 26  
FI-32700 Huittinen  
Tel. + 358 400 320 125  
orders.finland@sodeca.com

**HELSINKI**  
Smoke Control Solutions  
Mr. Antti Kontkanen  
Viipullantie 9C  
FI-00700 Helsinki  
Tel. +358 400 237 434  
akontkanen@sodeca.com  
Mrs. Kaisa Partanen  
Tel. +358 451 308 038  
kpartanen@sodeca.com

**HYVINKÄÄ**  
Smoke extraction and industrial  
applications  
Niinistökatu 12  
FI-05800 Hyvinkää  
Mr. Jaakko Tomperi  
Tel. +358 451 651 333  
jtomperi@sodeca.com  
Mr. Jarno Pikkumäki  
Tel. +358 407 723 472  
jpikkumaki@sodeca.com

**ITALIA**  
**Marelli Ventilazione, S.R.L.**  
Viale del Lavoro, 28  
37036 San Martino B.A.  
(VR), ITALY  
Tel. +39 045 87 80 140  
vendite@sodeca.com

**PORTUGAL**  
**Sodeca Portugal, Unip. Lda.**  
PORTO  
Rua Veloso Salgado 1120/1138  
4450-801 Leça de Palmeira  
Tel. +351 229 991 100  
geral@sodeca.pt

**LISBOA**  
Pq. Emp. da Granja Pav. 29  
2625-607 Vialonga  
Tel. +351 219 748 491  
geral@sodeca.pt

**ALGARVE**  
Rua da Alegria, 33  
8200-569 Ferreiras  
Tel. +351 289 092 586  
geral@sodeca.pt

**UNITED KINGDOM**  
**Sodeca Fans UK, Ltd.**  
Mr. Mark Newcombe  
Tamworth Enterprise Centre  
Philip Dix House, Corporation  
Street, Tamworth, B79 7DN  
UNITED KINGDOM  
Tel. +44 (0) 1827 216 109  
sales@sodeca.co.uk

## AMERICA

**CHILE**  
**Sodeca Ventiladores, SpA.**  
Sra. Sofía Ormazábal  
Santa Bernardita 12.005  
(Esquina con Puerta Sur)  
Bodegas 24 a 26,  
San Bernardo, Santiago, CHILE  
Tel. +56 22 840 5582  
ventas.chile@sodeca.com

**COLOMBIA**  
**Sodeca Latam, S.A.S.**  
Sra. Luisa Stella Prieto  
Calle7 No. 13 A-44  
Manzana 4 Lote1, Montaña  
Mosquera, Cundinamarca  
Bogotá, COLOMBIA  
Tel. +57 1 756 4213  
ventascolumbia@sodeca.co

**PERU**  
**Sodeca Perú, S.A.C.**  
Sr. Jose Luis Jiménez  
C/ Mariscal Jose Luis de  
Orbegoso 331. Urb. El pino.  
15022, San Luis. Lima, PERU  
Tel. +51 1 326 24 24  
Cel. +51 994671594  
comercial@sodeca.pe



#### HEADQUARTER

**Sodeca, S.L.U.**  
 Pol. Ind. La Barricona  
 Carrer del Metall, 2  
 E-17500 Ripoll  
 Girona, SPAIN  
 Tel. +34 93 852 91 11  
 Fax: +34 93 852 90 42  
 General sales: comercial@sodeca.com  
 Export sales: ventilation@sodeca.com

#### PRODUCTION PLANT

**Sodeca, S.L.U.**  
 Ctra. de Berga, km 0,7  
 E-08580 Sant Quirze de Besora  
 Barcelona, SPAIN  
 Tel. +34 93 852 91 11  
 Fax: +34 93 852 90 42  
 General sales: comercial@sodeca.com  
 Export sales: ventilation@sodeca.com



[www.sodeca.com](http://www.sodeca.com)

