



60 Hz

CATÁLOGO GENERAL



CASA MATRIZ

Ctra. de Berga, km 0,7
E-08580 SANT QUIRZE DE BESORA
Barcelona - SPAIN
Tel. +34 93 852 91 11
Fax +34 93 852 90 42
General sales: comercial@sodeca.com
Export sales: ventilation@sodeca.com

SODECA COLOMBIA

Calle7 No. 13 A-44
Manzana 4 Lote1
Mosquera Cundinamarca
Bogotá, COLOMBIA
Tel. +57 1 756 4213
ventascolombia@sodeca.com





NUESTRO COMPROMISO CON EL MEDIO AMBIENTE

Sodeca ha iniciado una nueva etapa de estudio y diseño de nuevas tendencias de ventilación que ayuden a la preservación del medio ambiente y al ahorro energético que tanto preocupa a la sociedad actual.



Para obtener una **mejora en la eficiencia energética** de los ventiladores y de las instalaciones de ventilación, el departamento de ingeniería energética de Sodeca ha **equilibrado los consumos de energía de los ventiladores** con sus máximos rendimientos, en las zonas habituales de trabajo, siendo necesario para esto una reestructuración de las curvas y su presentación en este y en futuros catálogos de Sodeca.

SODECA centra su actividad en la producción de ventiladores industriales, sistemas de ventilación y extractores para la evacuación de humos en caso de incendio, desde 1983 año de su fundación.

Los ventiladores y extractores de **SODECA** están presentes en todos los países Europeos y en gran parte del mundo, gracias a la calidad del producto y a los métodos de investigación y desarrollo utilizados.

Nuestros procedimientos de calidad utilizados y certificados por BUREAU VERITAS, según ISO 9001:2015, son otra de las razones que sitúan a **SODECA** como uno de los mejores y más reconocidos fabricantes de ventiladores de Europa.

Sin duda el factor más importante para alcanzar nuestros objetivos, es el factor humano, grandes profesionales que trabajan a su servicio, ofreciendo no solo equipos de ventilación, sino soluciones a cualquier necesidad de ventilación planteada por nuestros clientes.

Les ofrecemos con toda sinceridad, la posibilidad de visitar nuestras instalaciones en Sant Quirze de Besora, con más de 16.000 m² de superficie construida, donde podrá ver con toda claridad nuestra fabricación de ventiladores, con las más altas exigencias de calidad, cumpliendo con las normativas de ISO y AMCA.

Este catálogo es solo un pequeño detalle de nuestras posibilidades, no dude en contactar con nosotros, ponemos toda nuestra experiencia y nuestro equipo humano a su disposición.

SODECA Colombia
TORNADO

SODECA Perú

SODECA Chile





VENTILADORES Y EXTRACTORES INDUSTRIALES

Sodeca se ha especializado desde sus orígenes en el diseño y la fabricación de ventiladores y sus accesorios para aplicaciones industriales.

La unión de la experiencia adquirida durante décadas de trabajo con ventiladores, junto con la tecnología aportada por ingenieros distribuidos en diferentes departamentos, ha permitido que Sodeca se sitúe entre los mayores fabricantes de ventilación industrial del mundo.

Las aplicaciones industriales requieren gran capacidad de adaptación a las especificaciones de cada proyecto y flexibilidad en la fabricación, para cumplir con las necesidades reales de cada cliente.

Para cumplir con este objetivo Sodeca dispone de una línea de productos Standard y una línea de productos de fabricación especial, para la construcción de ventiladores adaptados a las exigencias de nuestros clientes.

Durante años se ha invertido de forma constante, en el desarrollo de procesos y aplicaciones internas, para conseguir la fabricación y el suministro de ventiladores industriales especiales, con un tiempo de diseño y fabricación extremadamente reducido.

El trabajo en equipo de nuestro departamento de ingeniería, junto con universidades y centros tecnológicos, así como la estrecha colaboración entre los departamentos de diseño de nuestros colaboradores externos, hace posible conseguir innovadoras soluciones de ventilación industrial en un corto plazo de tiempo.

A lo largo de nuestra historia hemos desarrollado todo tipo de tecnología en ventiladores para aplicaciones industriales que actualmente están repartidos por todo el mundo, nuestro objetivo es seguir invirtiendo en este sector para seguir siendo uno de los fabricantes de ventiladores industriales más reconocidos en el mundo.



EXTRACTORES EN LÍNEA PARA CONDUCTOS

12

SVE	SVE/PLUS	NEOLINEO/V	NEOSILENT	EDMF
 <p>Extractores en línea para conductos</p>	 <p>Extractores en línea para conductos con aislamiento acústico de 40 mm</p>	 <p>Extractores en línea para conductos con cuerpo extraíble y tamaño reducido</p>	 <p>Extractores en línea para conductos de bajo nivel sonoro</p>	 <p>Extractores de baño extraplano, con estético y moderno diseño</p>
13	13	19	21	24

EXTRACTORES AXIALES

26

HC  Ventiladores helicoidales murales con motor IP-55	HGI  Ventiladores helicoidales de gran diámetro	HCD  Ventiladores helicoidales murales de pequeño diámetro	HCH  Ventiladores helicoidales murales y tubulares de gran robustez	HCT  Ventiladores helicoidales murales y tubulares de gran robustez
27	33	35	37	37
CJHCH  Unidades de ventilación helicoidales, con caja aislada acústicamente	HCT/IMP-C  Jet fans de gran alcance circulares unidireccionales o reversibles	HCT/IMP  Jet fans de gran alcance unidireccionales o reversibles	HFV  Ventiladores tubulares galvanizados en caliente	HTP  Extractores helicoidales tubulares de alta presión
49	52	54	57	62
HGT HGTX  Ventiladores helicoidales tubulares de gran diámetro con motor directo	HPX  Ventiladores helicoidales tubulares con motor exterior	HBA  Ventiladores helicoidales tubulares bifurcados		
75	102	105		









EXTRACTORES **CENTRÍFUGOS**

107

CI-CO  Jet fans centrifugos de inducción y de gran alcance con bajo perfil 110	CMX  Extractores centrifugos tipo VENT-SET, accionados a transmisión con turbina a reacción 111	CBD  Ventiladores centrifugos de baja presión y doble aspiración, con motor directo 120	CJBD/ALG  Unidades de ventilación con perfilera de aluminio y chapa de acero galvanizada aisladas acústicamente 123	CBX  Ventiladores centrifugos de doble aspiración, accionados a transmisión 126
CBXC  Ventiladores centrifugos de doble aspiración, accionados a transmisión 126	CBXR  Ventiladores centrifugos de doble aspiración, accionados a transmisión 126	CBXT  Ventiladores centrifugos de doble aspiración, accionados a transmisión 126	CJBX/ALG  Unidades de ventilación a transmisión con perfilera de aluminio y chapa de acero galvanizada, aisladas acústicamente 136	CDXR  Ventiladores a transmisión de doble aspiración 144
CDXRT  Ventiladores a transmisión de doble aspiración 144	CJDXR  Unidades de ventilación a transmisión de doble aspiración 144	CSXR  Ventiladores de simple aspiración a transmisión 153	CSXRT  Ventiladores de simple aspiración a transmisión 153	CJSXR  Unidades de ventilación de simple aspiración a transmisión 153
TSA  Ventiladores de simple aspiración a transmisión 165	TSAT  Ventiladores de simple aspiración a transmisión 165	CJTSA  Unidades de ventilación de simple aspiración a transmisión 165	CJBR  Unidades de ventilación aisladas acústicamente con panel tipo sandwich, con sentido lineal del aire entre aspiración e impulsión 173	CMP  Ventiladores centrifugos de media presión equipados con turbina en chapa de acero o aluminio 175
CMR  Ventiladores centrifugos de media presión y de gran robustez 183	CMA  Ventiladores centrifugos de media presión con turbina en fundición de aluminio 188	CPV  Ventiladores centrifugos anticorrosivos de material plástico 191	CA  Ventiladores centrifugos de alta presión en fundición de aluminio 196	CAS  Ventiladores centrifugos de alta presión en chapa de acero 199
CAS-S  Ventiladores centrifugos de alta presión en chapa de acero con atenuador acústico 199				

EXTRACTORES DE TEJADO

205

VC-HDU  Extractores centrifugos de tejado a transmisión con salida de aire vertical 208	CXT  Ventiladores centrifugos de cubierta, para impulsión de aire vertical u horizontal a transmisión 217	RFH  Extractores centrifugos de tejado 400°C/2h con salida de aire horizontal 222	RFV  Extractores centrifugos de tejado 400°C/2h con salida de aire vertical 222	CRF  Extractores centrifugos de tejado con bajo nivel sonoro 227
HT  Extractores helicoidales de tejado con base plana 230	HTMH  Extractores de cubierta multifuncional para grandes caudales 233	HTMV  Extractores helicoidales de cubierta con salida de aire vertical 240		

EXTRACTORES PARA LA EVACUACIÓN DE HUMOS EN PARQUEADORES Y SIMILARES F-300 F-400

CERTIFICADO F-400



267

THT  Extractores helicoidales tubulares 400°C/2h y 300°C/2h 272	CJTHT  Ventiladores helicoidales 400°C/2h, 300°C/2h y 200°C/2h. Con caja aislada acústicamente 325	THT/IMP  Jet fans de gran alcance 400°C/2h y 300°C/2h, unidireccionales o reversibles, con diseño circular o octogonal 331	CI  Ventiladores centrifugos de inducción e impulso de gran alcance 300°C/2h y 400°C/2h 335	HTMF  Extractores de cubierta multifuncional 400°C/2h y 300°C/2h 336
THT/ROOF  Extractores helicoidales de cubierta con salida de aire vertical 400°C/2h y 300°C/2h 343	TCR/R  Extractor centrifugo 400°C/2h con turbina a reacción 346	CJTCR/R  Unidades de extracción 400°C/2h con turbina a reacción 346	CJTX-C  Unidades de extracción 400°C/2h, con motor y transmisión en el interior de la caja 351	CJSX  Unidades de extracción 400°C/2h, a transmisión con ventilador de simple aspiración 359
CSX  Extractores centrifugos 400°C/2h, accionados a transmisión con turbina a reacción 365				

SOBREPRESIÓN DE ESCALERAS

374







KIT SOBREPRESIÓN  Sistema de presurización de escaleras, vías de escape o de confinamiento 381	KIT BOXPDS  Equipos de presurización para escaleras, rutas de escape y vestibulos 385	HATCH PDS  Equipos de presurización para escaleras, rutas de escape y vestibulos 387
--	---	--

CERTIFICADO ATEX

EXTRACTORES ATMÓSFERAS EXPLOSIVAS ATEX



390

<p>HCDF</p>  <p>Extractores helicoidales con marco cuadrado, con Certificación ATEX Ex d</p> <p>397</p>	<p>HDF</p>  <p>Extractores helicoidales con marco circular, con Certificación ATEX Ex d</p> <p>397</p>	<p>HCH/ATEX</p>  <p>Extractores helicoidales murales de gran robustez, con Certificación ATEX</p> <p>400</p>	<p>HCT/ATEX</p>  <p>Extractores helicoidales tubulares de gran robustez, con Certificación ATEX</p> <p>400</p>	<p>CMA/ATEX</p>  <p>Extractores centrífugos de media presión en fundición de aluminio, con certificación ATEX</p> <p>404</p>
<p>CMP/ATEX</p>  <p>Extractores centrífugos de media presión equipados con turbina multipala, con certificación ATEX</p> <p>406</p>	<p>CMR/ATEX</p>  <p>Extractores centrífugos de media presión y gran robustez, equipados con turbina a reacción, con certificación ATEX</p> <p>410</p>			

RECUPERADORES DE CALOR • UNIDADES DE FILTRACIÓN Y TRATAMIENTO DE AIRE

413

<p>RECUP</p>  <p>Recuperadores de calor configurables, con placas de flujo cruzado, para instalación horizontal (H) o vertical (V)</p> <p>419</p>	<p>SV/FILTER</p>  <p>Extractores en línea para conductos, con bajo nivel sonoro y diferentes etapas de filtración.</p> <p>423</p>	<p>UFR</p>  <p>Unidades de Filtración aisladas acústicamente con panel sándwich</p> <p>427</p>	<p>UDT</p>  <p>Unidades de ventilación con tratamiento de aire y motor directo.</p> <p>431</p>	<p>UDTX</p>  <p>Unidades de ventilación con tratamiento de aire a transmisión.</p> <p>437</p>
---	---	--	---	---

CORTINAS DE AIRE

445

ECONOMIC



Cortinas de aire económicas, para pequeños recintos comerciales

447



NUEVA HERRAMIENTA PARA INGENIERÍAS Y DEPARTAMENTOS TÉCNICOS

MÓDULO DE PROYECTOS

Prepare informes técnicos en minutos

- Seleccione centenares de modelos en un solo paso.
- Cargue masivamente sus datos en Excel.
- Edite y gestione las fichas técnicas.
- Imprima el informe con índice y portada, edítelo o envíelo a otro QuickFan.



Búsqueda
fácil



Personalice
los informes



Siempre
actualizado



Informes en
minutos



CÁLCULO DE SOBREPRESIÓN EN ZONAS DE ESCALERAS

- Calcule rápidamente el caudal necesario para la sobrepresión de escaleras para los sistemas más habituales, requerido según UNE-EN 12101:2006.
- Configure fácilmente el diseño para cada planta, o áreas de la vía de evacuación.



MODELOS EN CAD 3D

- Descárguese nuestros ventiladores en Cad 3D desde nuestra web.
- Elija entre más de 40 formatos Cad disponibles incluyendo Revit.
- Más de 2.000 modelos y configuraciones disponibles.



Modelos
CAD 3D



Formatos
disponibles



Siempre
actualizado



Informes en
minutos



Disponible en:



CUMPLIMIENTO DE NORMAS

Los ventiladores y extractores de SODECA, cumplen con las siguientes normativas:

CALIDAD	
ISO 9001:2015	Sistemas de gestión de la calidad. Requisitos. Quality management systems -- Requirements
ENSAYOS	
UNE-EN ISO 5801	Ventiladores industriales. Ensayos de comportamiento en circuitos normalizados. Industrial fans -- Performance testing using standardized airways
AMCA 210-07	Ventiladores industriales. Métodos de ensayos de ventiladores y su representación de ensayos. Laboratory Methods of Testing Fans for Aerodynamic Performance Rating
UNE EN ISO 13350	Ventiladores industriales. Ensayos de comportamiento de ventiladores de chorro. Industrial fans -- Performance testing of jet fans
ISO 13348	Industrial fans -- Tolerances, methods of conversion and technical data presentation
VENTILADORES PARA ALTA TEMPERATURA	
EN 12101-3	Sistemas de control de humos y calor. Parte 3: Especificaciones para aireadores extractores de humos y calor mecánicos. Smoke and heat control systems - Part 3: Specification for powered smoke and heat exhaust ventilators
ACÚSTICA	
EN ISO 3744	Acústica. Determinación de los niveles de potencia acústica de fuentes de ruido a partir de la presión acústica. Método de ingeniería para condiciones de campo libre sobre un plano reflectante. Acoustics -- Determination of sound power levels of noise sources using sound pressure -- Engineering method in an essentially free field over a reflecting plane
EQUILIBRADO Y VIBRACIONES	
ISO 1940-1	Vibraciones mecánicas. Calidad de equilibrado Mechanical vibration -- Balance quality requirements for rotors in a constant (rigid) state -- Part 1: Specification and verification of balance tolerances
ISO 10816-1	Vibraciones mecánicas. Evaluación de las vibraciones de máquinas Mechanical vibration -- Evaluation of machine vibration by measurements on non-rotating parts -- Part 1: General guidelines
ISO 14694	Ventiladores industriales. Especificaciones para equilibrado y niveles de vibración Industrial fans -- Specifications for balance quality and vibration levels
SEGURIDAD (Declaración de Conformidad CE)	
EN ISO 12100-1	Seguridad de las máquinas. Conceptos básicos, principios generales para el diseño. Parte 1: Terminología básica, metodología. Safety of machinery -- Basic concepts, general principles for design -- Part 1: Basic terminology, methodology
EN ISO 12100-2	Seguridad de las máquinas. Conceptos básicos, principios generales para el diseño. Parte 2: Principios técnicos. Safety of machinery -- Basic concepts, general principles for design -- Part 2: Technical principles
UNE EN 60204-1	Seguridad de las máquinas. Equipo eléctrico de las máquinas. Parte 1: Requisitos generales. Safety of machinery - Electrical equipment of machines - Part 1: General requirements
EN ISO 13857	Seguridad de máquinas. Distancias de seguridad para impedir que se alcancen zonas peligrosas con los miembros superiores e inferiores. Safety of machinery -- Safety distances to prevent danger zones being reached by upper and lower limbs
UNE EN ISO 12499	Ventiladores industriales. Seguridad mecánica en los ventiladores Industrial fans -- Mechanical safety of fans -- Guarding
DIRECTIVAS Y REGLAMENTOS	
Directiva 2006/42/CE	Directiva de máquinas Machinery Directive
Directiva 2014/35/UE	Directiva de baja tensión Low Voltage Directive
Directiva 2014/30/UE	Directiva compatibilidad electromagnética EMC Directive
Reglamento 305/2011	Directiva productos de construcción Construction Products Directive (CPR)
Directiva 2009/125/CE	Directiva de requisitos de diseño ecológico para productos que utilizan energía. Ecodesign Requirements for Energy-related Products Directive
EJECUCIONES ATEX	
Directiva ATEX 2014/34/UE	Aparatos y sistemas de protección para uso en atmósferas potencialmente explosivas Equipment and protective systems intended for use in potentially explosive atmospheres
EN 14986	Diseño de ventiladores para trabajar en atmósferas potencialmente explosivas. Design of fans working in potentially explosive atmospheres
EN 13463-1	Equipos no eléctricos destinados a atmósferas potencialmente explosivas. Parte 1: Requisitos y metodología básica. Non-electrical equipment for use in potentially explosive atmospheres - Part 1: Basic method and requirements
EN 1127-1	Atmósferas explosivas. Prevención y protección contra la explosión. Parte 1: Conceptos básicos y metodología. Explosive atmospheres - Explosion prevention and protection - Part 1: Basic concepts and methodology

WORLD WIDE

SODECA Group

350

Staff
Empleados
Personnel
Personal

5

Presence on 5 continents
Presencia en 5 continentes
Présence sur 5 continents
Präsenz auf 5 Kontinenten

5

Production plants
Plantas de producción
Usines de production
Fertigungsanlagen

1

European Centre for Research
Centro europeo de Investigación
Centre européen pour la recherche
Europäisches Zentrum für die Forschung

117

Commercial presence in 117 countries
Presencia comercial en 117 países
La présence commerciale dans 117 pays
Kommerzielle Präsenz in 117 Ländern

7

World Branches
Filiales en el mundo
Implantations mondiales
Niederlassungen

4200

Products in catalogue
Productos en catálogo
Produits du catalogue
Produkte im Katalog

ISO 9001:2015

Quality
Calidad
Qualité
Qualität

Erp 2015/2016/2018



Efficiency
Eficiencia
Efficacité
Leistungsfähigkeit

AMCA 210-07

Trials
Ensayos
Essais
Studien

EN-12101-3



Trials temperature
Ensayos temperatura
Essais température
Test Temperatur

ISO 3744

Acoustic
Acustica
Acoustique
Akustisch

ISO 1940-1

Balanced
Equilibrado
Équilibré
Ausgeglichen

EN-ISO 12100

Security
Seguridad
Sécurité
Sicherheit

**Directiva
2009/125/CE**

Directives
Directivas
Directives
Richtlinien

EN-14986

ATEX



5

Production plants

7

World Branches

117

Commercial presence
in 117 countries

5

Continents

SODECA Group

CASA MATRIZ



Sodeca S.L.U.

Ctra. de Berga, km 0,7
E-08580 SANT QUIRZE DE BESORA
Barcelona, SPAIN
Tel. +34 93 852 91 11
Fax +34 93 852 90 42
General sales: comercial@sodeca.com
Export sales: ventilation@sodeca.com
www.sodeca.com



FILIALES

SODECA Colombia



COLOMBIA
Sodeca Latam S.A.S
Sra. Luisa Stella Prieto
Calle7 No. 13 A-44
Manzana 4 Lote1
Mosquera, Cundinamarca
Bogotá, COLOMBIA
Tel. +57 1 756 4213
ventascolombia@sodeca.co

SODECA Chile

CHILE
Sodeca Ventiladores Ltda
Sr. Frederic Cousquer
Santa Bernardita 12.005
(Esquina con Puerta Sur)
Bodegas 24 a 26,
San Bernardo Santiago, CHILE
Tel. +56 22 840 5582
ventas.chile@sodeca.com

SODECA Perú

PERÚ
Sodeca Perú SAC
Sr. Jose Luis Jimenez
C/ Mariscal Jose Luis de
Orbegoso 331. Urb. El pino.
15022 , San Luis. Lima, PERÚ
Tel. +51 1 326 24 24
Cel. +51 994671594
comercial@sodeca.pe

SODECA Finland

FINLAND
Sodeca Finland Oy
Mr. Kai Yli-Sipilä
Metsälinnankatu 30, PL2
FI-32700 Huittinen
FINLAND
Tel. + 358 400 320 125
orders.finland@sodeca.com

SODECA Portugal
decflex

PORTUGAL
**Sodeca Portugal
Unipessoal Lda**
PORTO
Rua Veloso Salgado 120/1138
4450-801 Leça de Palmeira
Tel. +351 229 991 100
Fax. +351 229 991 119
geral@sodeca.pt

PORTUGAL
**Sodeca Portugal
Unipessoal Lda**
LISBOA
Parque Empresarial da Granja
Pavilhão 8, 2625-607 Vialonga
Tel. +351 219 748 491
Fax. +351 219 748 493
geral@sodeca.pt

SODECA Fans UK

UNITED KINGDOM
Sodeca Fans UK Ltd
Mr. Mark Newcombe
Tamworth Enterprise Centre
Philip Dix House
Corporation Street
Tamworth , B79 7DN
UNITED KINGDOM
Tel. +44 (0) 1827 264 435
sales@sodeca.co.uk

PLANTAS DE
PRODUCCIÓN

SODECA Group
Production plant

SANT QUIRZE DE BESORA
Barcelona - SPAIN

SODECA Group
Production plant

MADRID
SPAIN

SODECA Group
pideca

TORELLÓ
Barcelona - SPAIN

SODECA Group
Production plant

BOGOTÁ
COLOMBIA

SODECA Group
Production plant

SANTIAGO DE CHILE
CHILE

EXTRACTORES EN LÍNEA PARA CONDUCTOS

SVE	SVE/PLUS	NEOLINEO/V	NEOSILENT	EDMF
 <p>Extractores en línea para conductos</p>	 <p>Extractores en línea para conductos con aislamiento acústico de 40 mm</p>	 <p>Extractores en línea para conductos con cuerpo extraíble y tamaño reducido</p>	 <p>Extractores en línea para conductos de bajo nivel sonoro</p>	 <p>Extractores de baño extraplano, con estético y moderno diseño</p>
13	13	19	21	24

SVE SVE/PLUS

SVE: Extractores en línea para conductos, con bajo nivel sonoro montados dentro de una envolvente acústica

SVE/PLUS: Extractores en línea para conductos, con bajo nivel sonoro montados dentro de una envolvente acústica de 40 mm de aislante acústico fonoabsorbente



SVE

Tapa registro abatible, excepto modelos 100-125-150/L-160/L



SVE/PLUS

Ventilador:

- Envolvente acústica recubierta de material fonoabsorbente
- Turbina con álabes a reacción excepto modelos 100-125-150-160-200/H, con turbina multipala.
- Bridas normalizadas en aspiración e impulsión, para facilitar la instalación en conductos
- Equipados con tapa registro abatible, excepto modelos 100-125-150/L-160/L
- Pies soporte integrados en la caja, que facilita su montaje
- Dirección aire sentido lineal

Motor:

- Motores de rotor exterior, con protector térmico incorporado, clase F, con rodamientos a bolas, protección IP54
- Monofásicos 220V 60Hz regulables
- Temperatura máxima del aire a transportar: + 50°C

Acabado:

- Anticorrosivo en chapa de acero galvanizada

Código pedido S interruptor incorporado

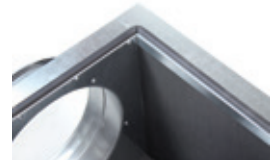

Aislante acústico de 40mm modelo SVE/PLUS

Código de pedido



SVE: Extractores en línea para conductos

SVE/PLUS: Extractores en línea para conductos con aislamiento de 40mm

Diámetro boca en mm

Nivel caudal.
H: Caudal alto
L: Caudal bajo

Interruptor paro marcha incorporado

60Hz

Características técnicas

Modelo	Velocidad (r/min)	Intensidad máxima admisible 220V (A)	Potencia eléctrica máx. (kW)	Caudal máximo (m³/h)	Nivel sonoro irradiado dB(A)	Peso aprox. (Kg)	Tipo de turbina
SVE-100/L	2160	0,45	0,10	290	44,10	5,5	Forward
SVE-125/H	2676	0,75	0,18	370	55,65	6,0	Forward
SVE-125/L	1800	0,45	0,10	310	45,15	5,5	Forward
SVE-150/H	2160	1,00	0,25	490	54,60	7,0	Forward
SVE-150/L	2160	0,45	0,10	355	54,60	6,0	Forward
SVE-160/H	2700	1,00	0,25	490	54,60	7,0	Forward
SVE-200/H	1680	0,75	0,18	760	44,10	12,0	Forward
SVE-200/L	3180	0,70	0,18	640	50,48	9,0	Backward
SVE-250/H	2880	0,75	0,18	1140	64,05	11,0	Backward
SVE-250/L	3300	0,75	0,17	705	55,65	9,5	Backward
SVE-315/H	1680	0,65	0,14	1315	48,30	17,5	Backward
SVE-350/H	1680	0,95	0,20	1555	46,20	21,5	Backward
SVE-400/H	1620	1,80	0,30	2310	48,30	27,0	Backward

Características técnicas

Modelo	Velocidad (r/min)	Intensidad máxima admisible 220V (A)	Potencia eléctrica máx. (kW)	Caudal máximo (m³/h)	Nivel sonoro irradiado dB(A)	Peso aprox. (Kg)	Tipo de turbina
SVE/PLUS-100/L	2160	0,45	0,10	290	28,35	9,0	Forward
SVE/PLUS-125/H	2808	0,75	0,18	370	39,90	9,5	Forward
SVE/PLUS-125/L	2160	0,45	0,10	310	29,40	9,0	Forward
SVE/PLUS-150/H	2700	1,00	0,25	490	37,80	12,0	Forward
SVE/PLUS-150/L	2160	0,45	0,10	355	27,30	9,5	Forward
SVE/PLUS-160/H	2700	1,00	0,25	490	37,80	12,0	Forward
SVE/PLUS-160/L	2160	0,45	0,10	355	27,30	9,5	Forward
SVE/PLUS-200/H	1680	0,75	0,18	760	39,90	16,5	Forward
SVE/PLUS-200/L	3180	0,70	0,18	640	38,85	13,5	Backward
SVE/PLUS-250/H	2880	0,75	0,18	1140	46,20	15,0	Backward
SVE/PLUS-250/L	3300	0,75	0,17	705	37,80	14,0	Backward
SVE/PLUS-315/H	1680	0,65	0,14	1315	43,05	23,0	Backward
SVE/PLUS-350/H	1680	0,85	0,20	1555	39,90	29,5	Backward
SVE/PLUS-400/H	1620	1,20	0,30	2310	43,05	33,0	Backward

Características acústicas

Los valores indicados se determinan mediante medidas de potencia sonora en dB(A) obtenidas en campo libre a una distancia equivalente a dos veces la envergadura del ventilador más el diámetro de la turbina, con un mínimo de 1,5m.

Espectro de potencia sonora Lw(A) en dB(A) por banda de frecuencia en Hz

Modelo	63	125	250	500	1000	2000	4000	8000	Modelo	63	125	250	500	1000	2000	4000	8000
SVE-100/L	23	31	36	35	34	35	31	25	SVE/PLUS-100/L	20	31	34	30	25	29	27	24
SVE-125/H	23	33	37	35	34	35	31	25	SVE/PLUS-125/H	30	43	45	40	35	39	37	34
SVE-125/L	21	31	32	34	35	36	32	26	SVE/PLUS-125/L	20	33	35	30	25	29	27	24
SVE-150/H	33	43	47	45	44	45	41	35	SVE/PLUS-150/H	28	41	40	39	36	40	38	35
SVE-150/L	31	41	42	44	45	46	42	36	SVE/PLUS-150/L	18	31	30	29	26	30	28	25
SVE-160/H	31	41	42	44	45	46	42	36	SVE/PLUS-160/H	28	41	40	39	36	40	38	35
SVE-200/H	28	39	46	47	47	45	42	33	SVE/PLUS-160/L	18	31	30	29	26	30	28	25
SVE-200/L	29	40	47	48	48	46	43	34	SVE/PLUS-200/H	26	40	45	43	39	40	39	33
SVE-250/H	27	37	42	48	47	46	43	35	SVE/PLUS-200/L	25	39	44	42	38	39	38	32
SVE-250/L	35	45	50	56	55	54	51	43	SVE/PLUS-250/H	32	45	48	51	46	48	47	42
SVE-315/H	30	40	45	52	53	51	48	39	SVE/PLUS-250/L	24	37	40	43	38	40	39	34
SVE-350/H	29	39	43	50	51	49	47	38	SVE/PLUS-315/H	27	40	43	47	44	45	44	38
SVE-400/H	32	42	46	53	54	52	50	41	SVE/PLUS-350/H	26	39	41	45	42	43	43	37
									SVE/PLUS-400/H	29	42	44	48	45	46	46	40

Dimensiones mm

SVE

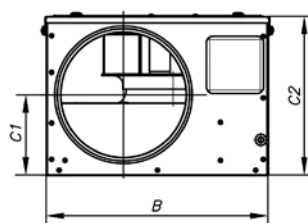
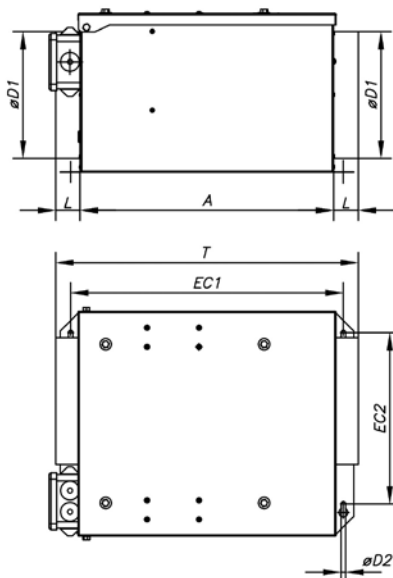

Modelo	A	B	C1	C2	ØD1	L	ØD2	EC1	EC2	T
SVE-100/L	300	265	82,5	180	100	36	7	330	205	372
SVE-125/L	300	265	80,5	180	125	36	7	330	205	372
SVE-125/H	300	265	80,5	180	125	36	7	330	205	372
SVE-150/L	300	265	88,5	180	150	40	7	330	205	380
SVE-150/H	300	260	100	195	150	40	7	330	190	380
SVE-160/H	300	260	100	195	160	40	7	330	190	380
SVE-200/L	400	350	127	250	200	40	7	430	270	480
SVE-200/H	400	350	127	250	200	40	7	430	270	480
SVE-250/L	400	350	142	290	250	48	7	430	280	496
SVE-250/H	400	350	142	290	250	48	7	430	280	496
SVE-315/H	515	480	175	355	315	48	7	545	405	610
SVE-350/H	575	545	211,5	410	350	58	7	605	445	690
SVE-400/H	650	610	230	455	400	74	7	680	520	800

Dimensiones mm

SVE/PLUS

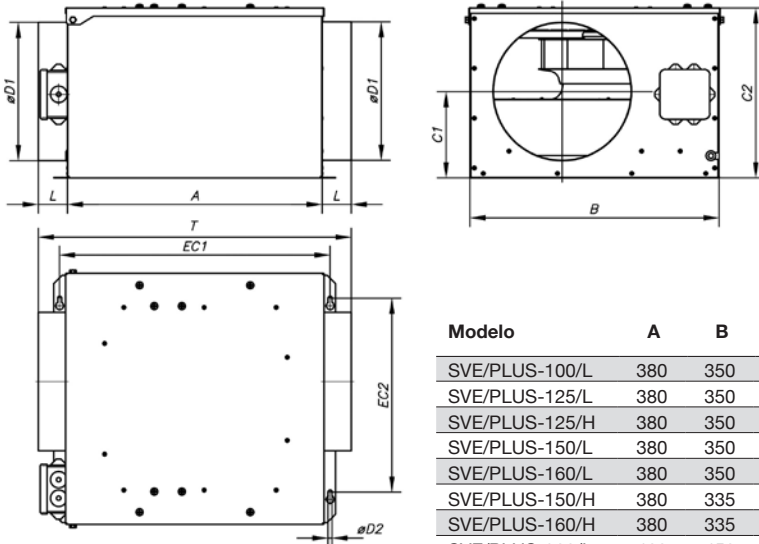

Modelo	A	B	C1	C2	øD1	L	øD2	EC1	EC2	T
SVE/PLUS-100/L	380	350	100	230	100	35	7	410	290	450
SVE/PLUS-125/L	380	350	100	230	125	35	7	410	290	450
SVE/PLUS-125/H	380	350	100	230	125	35	7	410	290	450
SVE/PLUS-150/L	380	350	110	230	150	35	7	410	290	450
SVE/PLUS-160/L	380	350	110	230	160	35	7	410	290	450
SVE/PLUS-150/H	380	335	165	265	150	37,5	7	405	265	455
SVE/PLUS-160/H	380	335	165	265	160	37,5	7	405	265	455
SVE/PLUS-200/L	460	450	162	285	200	37,5	7	490	380	535
SVE/PLUS-200/H	460	450	162	285	200	37,5	7	490	380	535
SVE/PLUS-250/L	460	450	156	310	250	52,5	7	490	380	565
SVE/PLUS-250/H	460	450	156	310	250	52,5	7	490	380	565
SVE/PLUS-315/H	565	540	210	390	315	57,5	9	595	440	680
SVE/PLUS-350/H	650	600	233,5	435	350	57,5	9	680	525	765
SVE/PLUS-400/H	650	680	263,5	500	400	77,5	9	680	600	805

Curvas características

Q= Caudal en m³/h, m³/s y cfm

Pe= Presión estática en mmH²O, Pa e inwg.

SVE

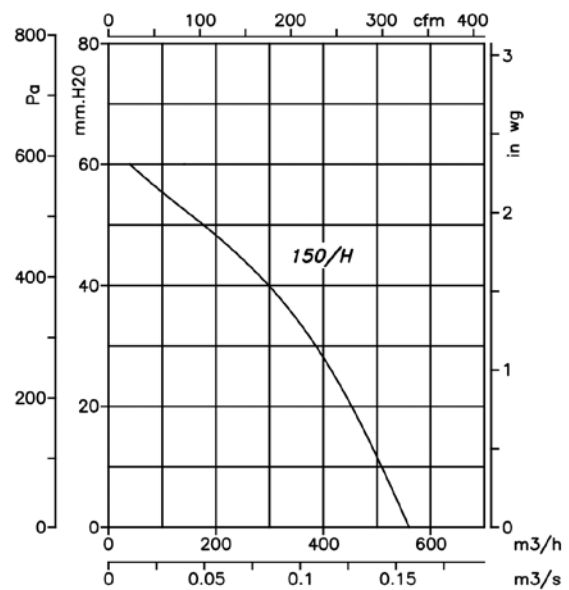
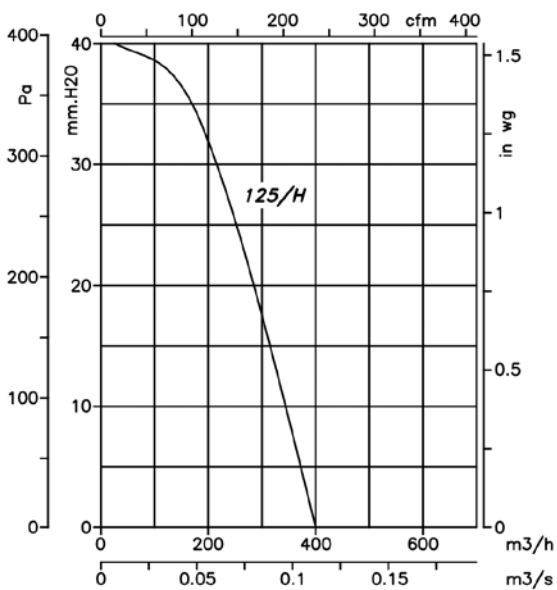

Curvas características

Q= Caudal en m³/h, m³/s y cfm

Pe= Presión estática en mmH₂O, Pa e in wg.

SVE

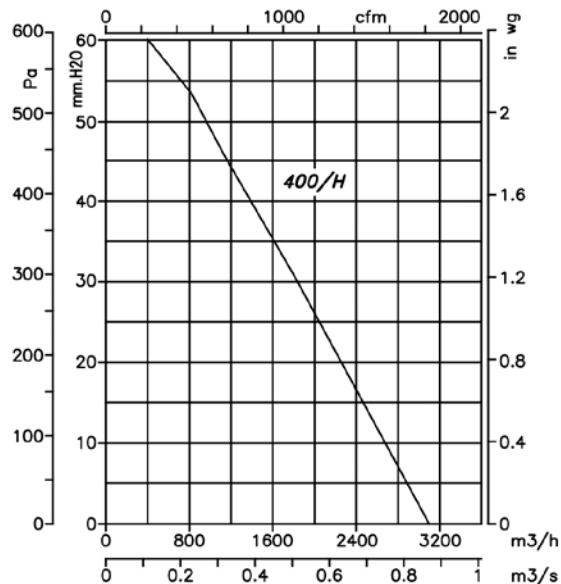
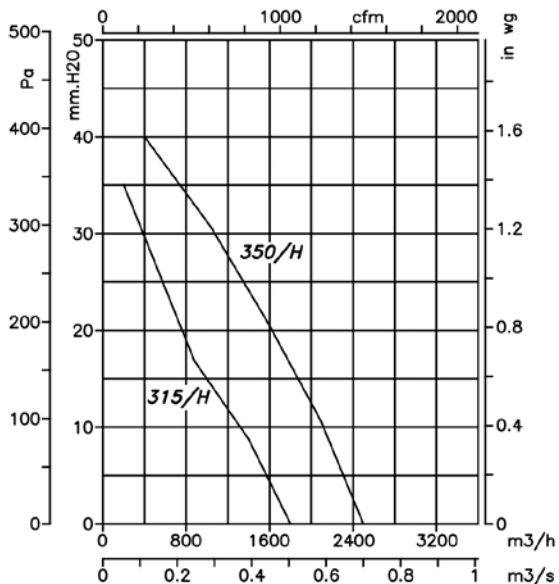
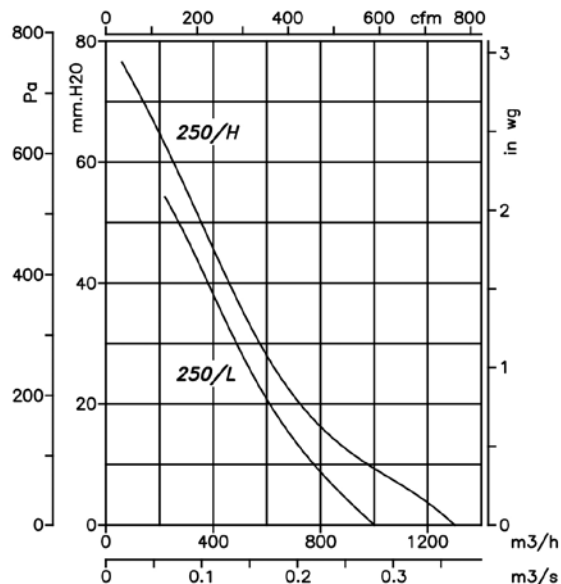
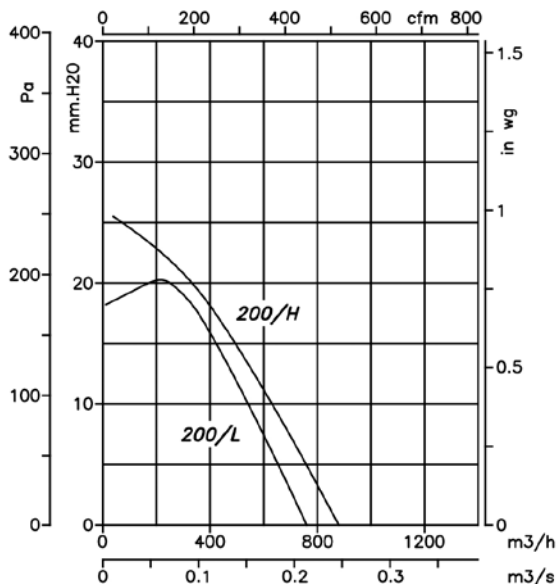

Curvas características

Q= Caudal en m³/h, m³/s y cfm

Pe= Presión estática en mmH₂O, Pa e in wg.

SVE/PLUS

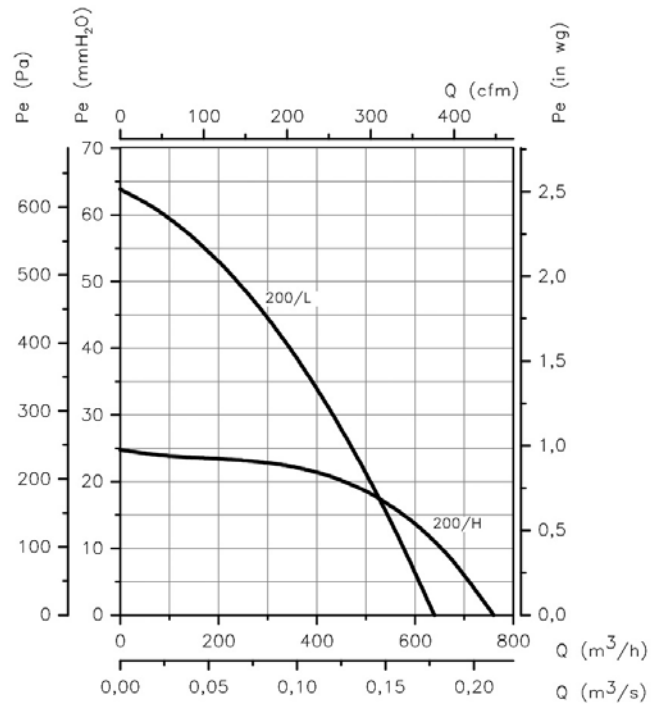
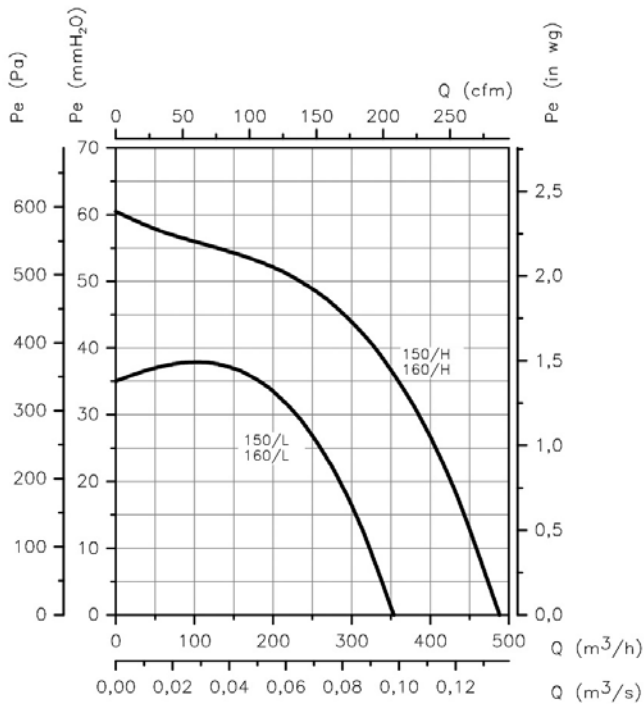
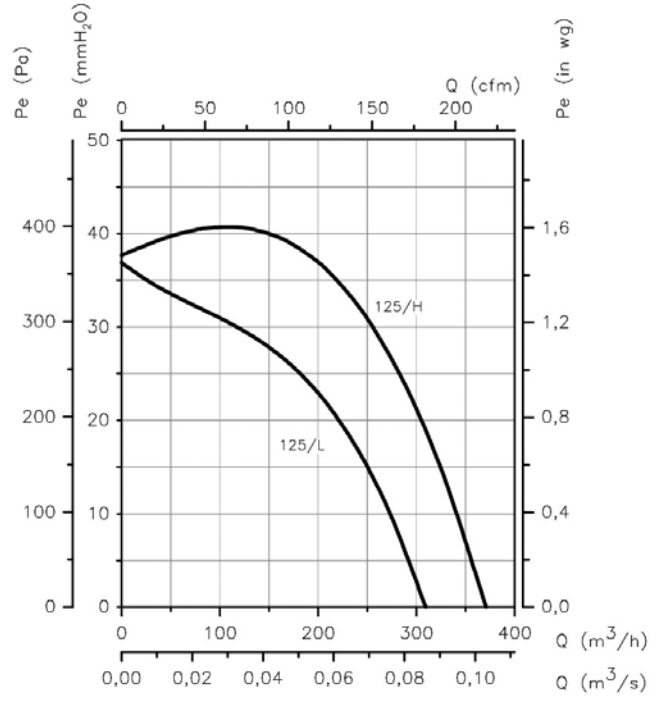
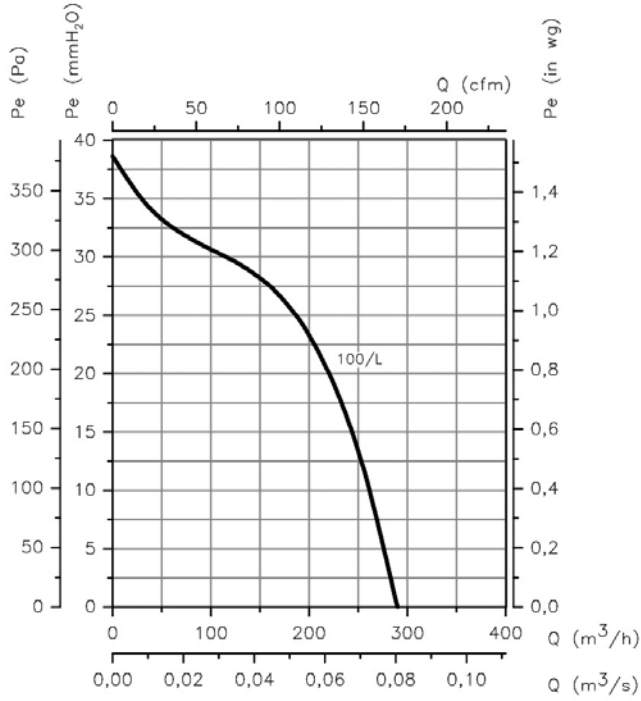

Curvas características

Q= Caudal en m³/h, m³/s y cfm

Pe= Presión estática en mmH₂O, Pa e inwg.

SVE/PLUS

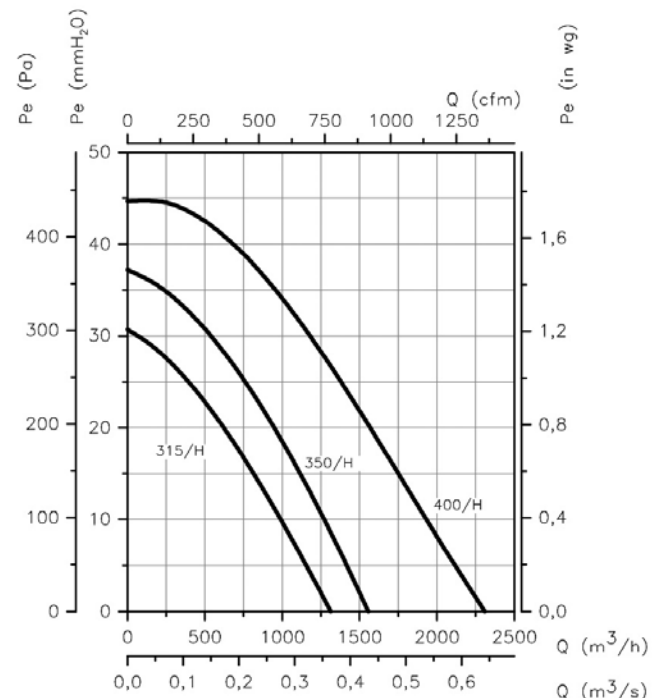
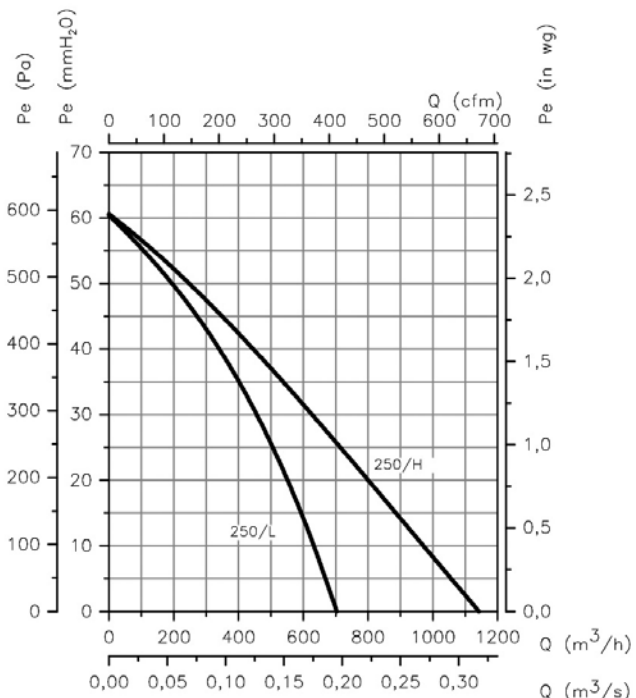

Accesorios



NEOLINEO/V

Extractores en línea para conductos con cuerpo extraíble y tamaño reducido con rodamientos a bolas de Larga Duración



Ventilador:

- Envoltorio en material plástico autoextinguible V0
- Caja de bornes externa, con posición variable
- Instalación rápida y sencilla

Motor:

- Motores con rodamientos a bolas de Larga Duración, protección IPX4, de dos velocidades y regulables
- Monofásicos 110/120V. 60Hz o 220V 60Hz
- Temperatura de trabajo: -10°C +60°C

Acabado:

- En material plástico, de color blanco, autoextinguible al fuego V0

Código de pedido

NEOLINEO/V — 100 — (Q) — (T) — 1 — 60HZ

NEOLINEO/V: Extractores en línea para conductos con cuerpo extraíble

Diámetro boca en mm

Referencia con Q, nivel caudal bajo

Referencia con T, incorpora temporizador

1: Alimentación 110V 60Hz
2: Alimentación 220V 60Hz

60Hz

Características técnicas

Modelo	Velocidad (r/min)	Intensidad máxima admisible (A) min/max	Potencia eléctrica máx. (kW) min/max	Caudal máximo (m³/h) min/max	Nivel sonoro irradiado* dB(A) min/max	Peso aprox. (Kg)
NEOLINEO 100/V	2180 / 2385	0,11 / 0,21	0,021 / 0,033	145 / 187	26 / 30	1,5
NEOLINEO 125/V	1950 / 2455	0,18 / 0,27	0,023 / 0,037	220 / 280	28 / 35	1,4
NEOLINEO 150/V	1680 / 2460	0,17 / 0,27	0,030 / 0,060	405 / 520	30 / 35	2,7
NEOLINEO 160/V	1680 / 2460	0,17 / 0,27	0,030 / 0,060	405 / 520	30 / 35	2,7
NEOLINEO 200/V	1915 / 2380	0,34 / 0,48	0,076 / 0,108	830 / 1040	32 / 38	4,0
NEOLINEO 250/V	1955 / 2440	0,54 / 0,79	0,125 / 0,177	1110 / 1400	45 / 55	7,8
NEOLINEO 315/V	1890 / 2430	1,00 / 1,42	0,230 / 0,320	1570 / 2050	49 / 58	11,9

*Los niveles de presión sonora irradiados, están obtenidos a 3 metros en campo libre, con tubos rígidos en aspiración y descarga.

Dimensiones mm

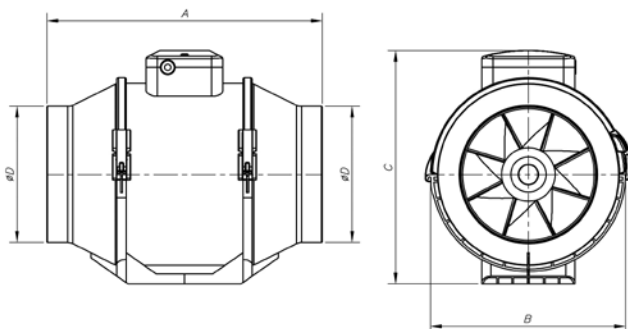

	A	B	C	øD
NEOLINEO 100/V	246	126	190	96
NEOLINEO 125/V	246	126	190	123
NEOLINEO 150/V	295	185	250	148
NEOLINEO 160/V	295	185	250	158
NEOLINEO 200/V	296	209	261	197
NEOLINEO 250/V	383	256	320	247
NEOLINEO 315/V	445	323	408	310

Curvas características

Q= Caudal en m³/h

Pe= Presión estática en Pa

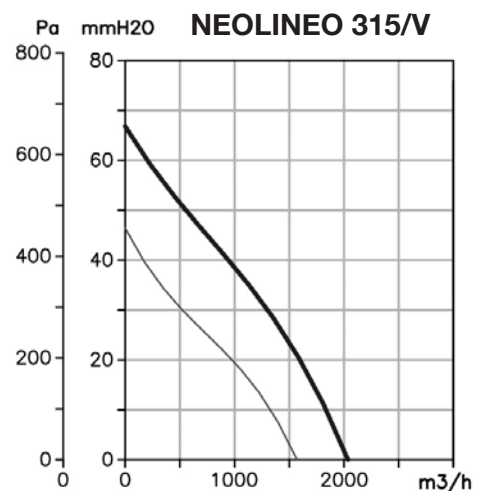
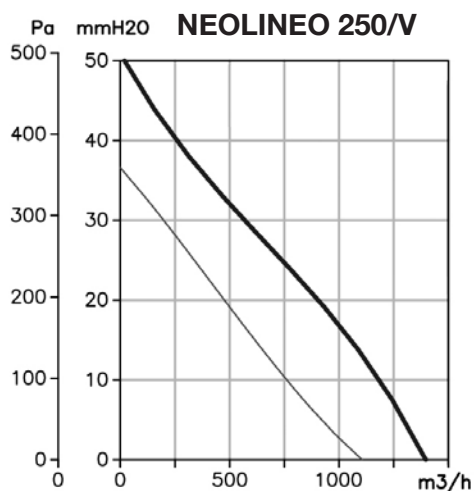
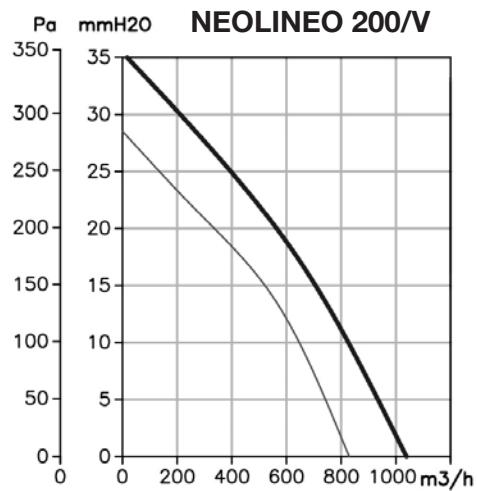
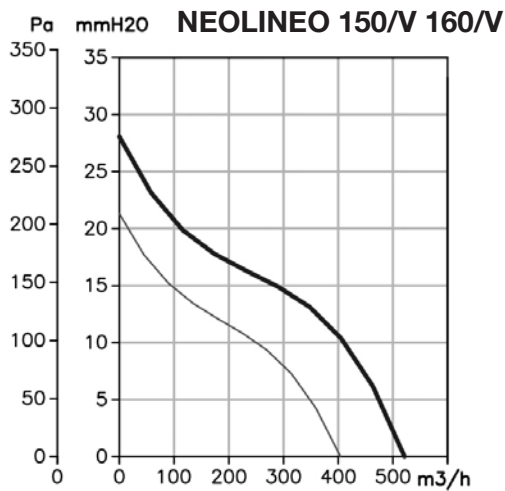
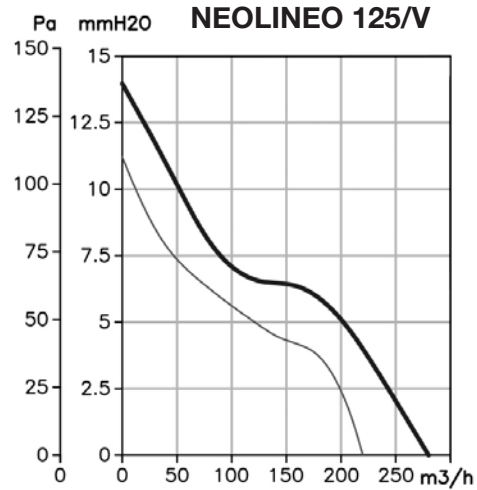
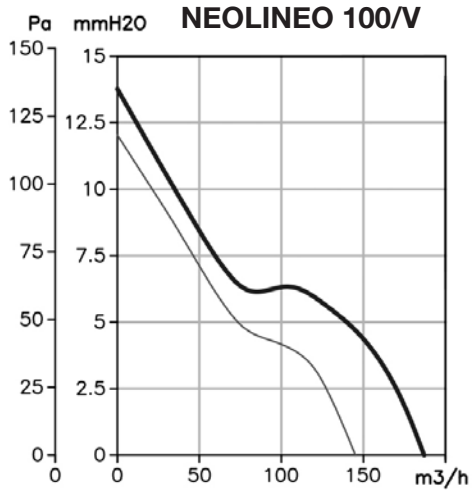

NEOSILENT

Extractores en línea para conductos de bajo nivel sonoro, con rodamientos a bolas de Larga duración



Ventilador:

- Envoltente en chapa de acero
- Aislado térmica y acústicamente con lana de roca
- Envoltente interior perforado para facilitar la absorción del ruido
- Caja de bornes externa
- Instalación rápida y sencilla

Motor:

- Motores con rodamientos a bolas de Larga Duración, protección IPX4, de dos velocidades
- Monofásicos 110-120V 60Hz o 220-240V 60Hz
- Temperatura de trabajo: -10°C +60°C

Acabado:

- Anticorrosivo en recubrimiento polimérico de color gris.

Código de pedido

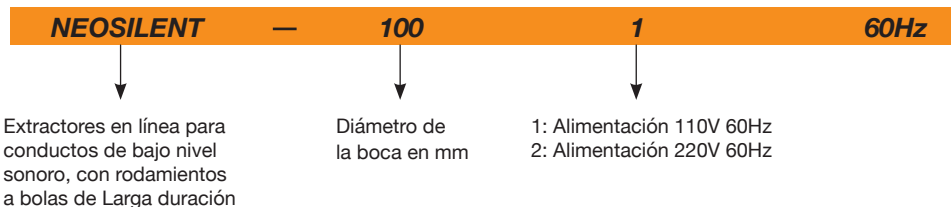

60Hz

Características técnicas

Modelo	Velocidad (r/min)	Intensidad máx. (A)	Potencia eléctrica máx. (kW)	Caudal máximo (m³/h)	Nivel sonoro irradiado* (dBA)	Peso aprox. (Kg)
	min / max	min / max	min / max	min / max	min / max	
NEOSILENT 100	2030 / 2630	0,10/0,11	0,024 / 0,026	170 / 240	24 / 29	4,6
NEOSILENT 125	1650 / 2310	0,11/0,13	0,025 / 0,030	230 / 340	23 / 28	4,6
NEOSILENT 150	1970 / 2645	0,20/0,23	0,045 / 0,052	405 / 555	26 / 33	6,1
NEOSILENT 200	2015 / 2445	0,35/0,49	0,078 / 0,110	810 / 1020	31 / 36	8,0
NEOSILENT 250	1965 / 2495	0,52/0,79	0,127 / 0,178	1050 / 1330	34 / 38	15,0
NEOSILENT 315	1975 / 2545	0,93/1,41	0,213 / 0,313	1530 / 1950	36 / 40	25,0

(*) Los niveles de presión sonora irradiados, están obtenidos a 3 metros en campo libre, con tubos rígidos en la aspiración y descarga.

Características acústicas

Espectro de potencia sonora Lw(A) en dB(A) banda de frecuencia en [Hz]

Modelo	63	125	250	500	1000	2000	4000	8000
NEOSILENT 100	15	14	17	25	29	21	22	14
NEOSILENT 125	17	20	23	27	28	22	21	15
NEOSILENT 150	19	22	39	35	36	33	24	21
NEOSILENT 200	22	30	31	38	41	42	29	22
NEOSILENT 250	25	33	48	41	53	49	41	29
NEOSILENT 315	25	32	41	51	55	52	49	37

Dimensiones mm

NEOSILENT 100...150

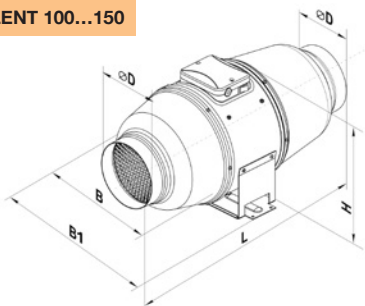

Modelo	ØD	B	B1	L	H
NEOSILENT 100	98	215	243	505	237
NEOSILENT 125	123	215	243	474	237
NEOSILENT 150	147	247	274	580	260

NEOSILENT 200...315

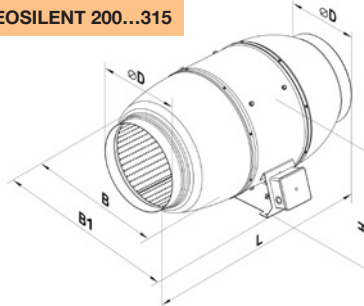

Modelo	ØD	B	B1	L	H
NEOSILENT 200	198	293	386	550	295
NEOSILENT 250	248	358	445	658	360
NEOSILENT 315	313	432	520	780	434

Curvas características

Q= Caudal en m³/h

Pe= Presión estática en Pa

NEOSILENT 100

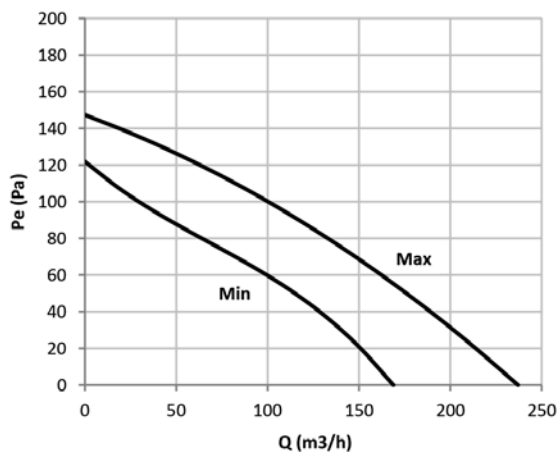

NEOSILENT 125

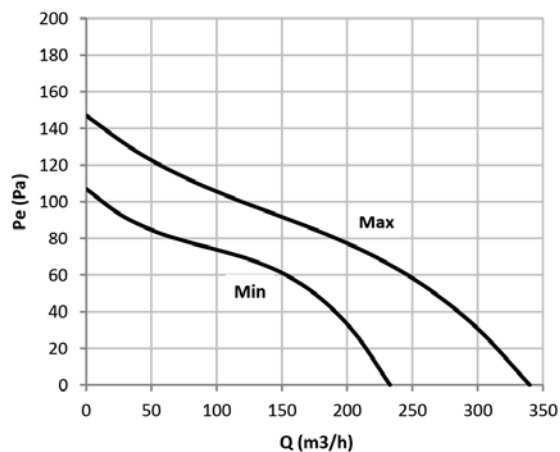

NEOSILENT 150

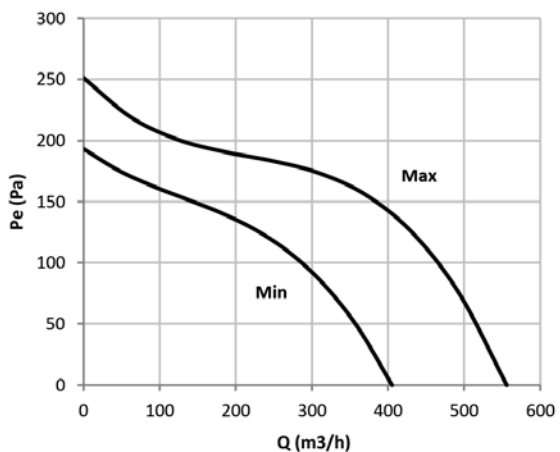

NEOSILENT 200

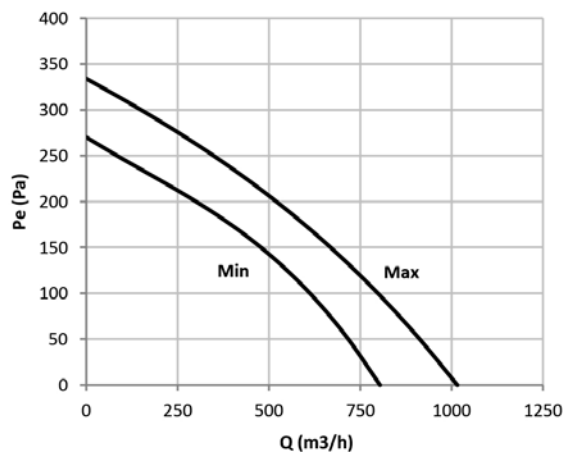

Curvas características

Q= Caudal en m³/h

Pe= Presión estática en Pa

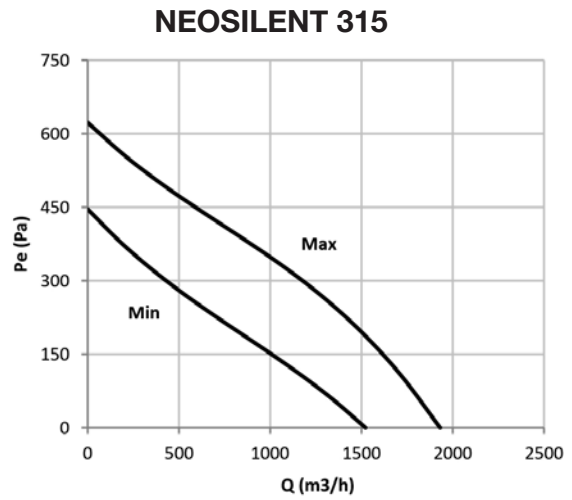
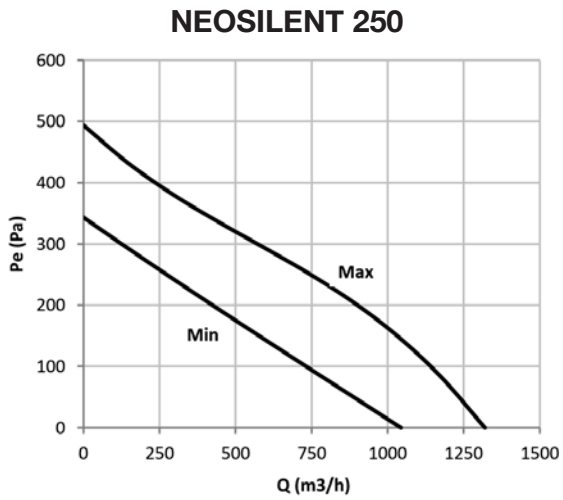

Accesorios



Compuertas antiretorno



Rejillas fijas



Reguladores electrónicos de velocidad



Cajas de filtros de aire



Baterías eléctricas



Interruptor de 2 velocidades DUO



SI



Bocas de salida para viviendas



Silenciador

EDMF



Extractores de baño extraplano, con estético y moderno diseño

- Integración arquitectónica con los elementos del baño
- Ultrasilenciosos
- Diseño extraplano con solo 17 mm del grosor
- Alto rendimiento gracias a su aerodinámico diseño
- Fácil y rápida instalación

Construcción:

- Acabado en blanco
- Compuerta anti-retorno incorporada en todos los modelos
- Construido con materiales reciclables

Versión

- BASIC: funciona con el interruptor de la luz o independiente
- TIMER: funciona con temporizador electrónico regulable
- LL: Rodamientos a bolas Long Life

Motor:

- Monofásico 110V 60Hz o 220V 60Hz según pedido



Código de pedido

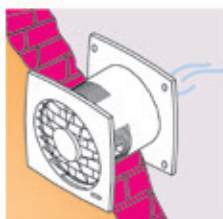
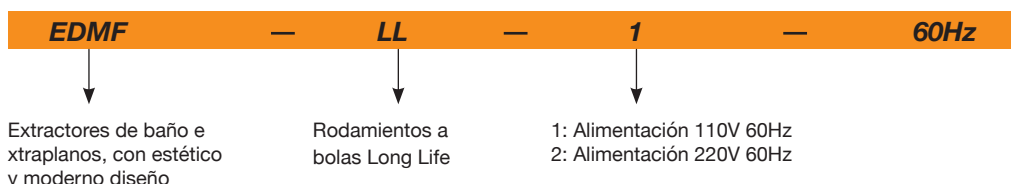

Características técnicas

60Hz

Modelo	Versión	Velocidad (rpm)	Potencia eléctrica máxima (kW)	Caudal máximo (m³/h)	Nivel sonoro dB(A)	Peso (Kg)
EDMF-100	Basic	2300	14	95	34	0,58
EDMF-100-T	Timer	2300	14	95	34	0,58
EDMF-100-LL	LL	2300	14	95	34	0,58
EDMF-100-LL-T	LL/Timer	2300	14	95	34	0,58
EDMF-120	Basic	2400	16	180	35	0,74
EDMF-120-T	Timer	2400	16	180	35	0,74
EDMF-120-LL	LL	2400	16	180	35	0,74
EDMF-150	Basic	2400	24	292	38	0,92
EDMF-150-T	Timer	2400	24	292	38	0,92
EDMF-150-LL	LL	2400	24	292	38	0,92

Dimensiones mm

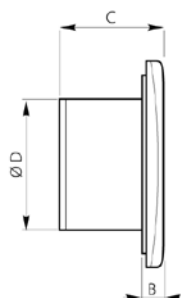
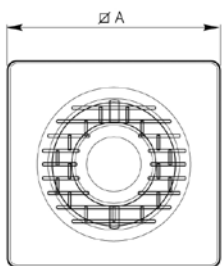

Modelo	∅A	B	C	∅D
EDMF-100	150	12,5	108	98
EDMF-100-T	150	12,5	108	98
EDMF-100-LL	150	12,5	108	98
EDMF-100-LL-T	150	12,5	108	98
EDMF-120	176	12,5	114	124
EDMF-120-T	176	12,5	114	124
EDMF-120-LL	176	12,5	114	124
EDMF-150	205	13	132	149
EDMF-150-T	205	13	132	149
EDMF-150-LL	205	13	132	149

Curvas características

Q= Caudal en m³/h y m³/s. Pe= Presión estática en Pa

EDMF 100

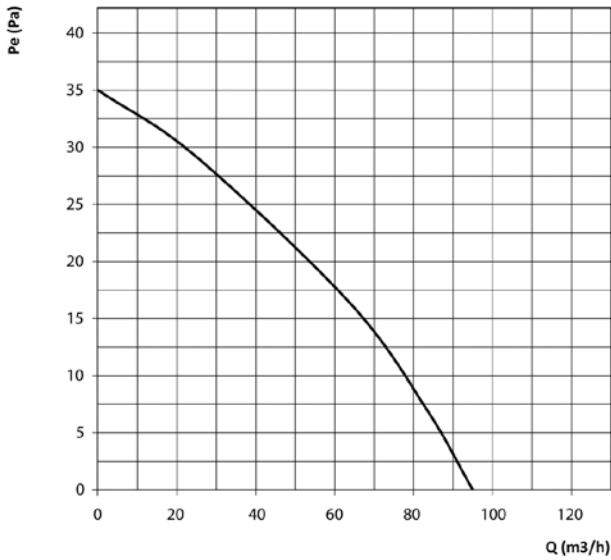

EDMF 125

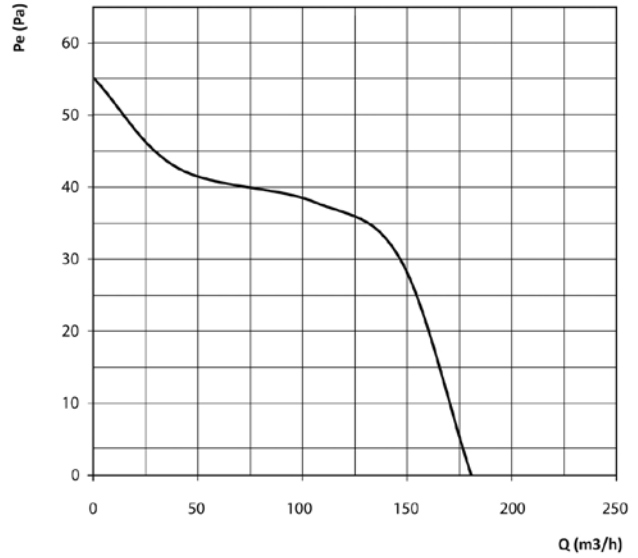

EDMF 150

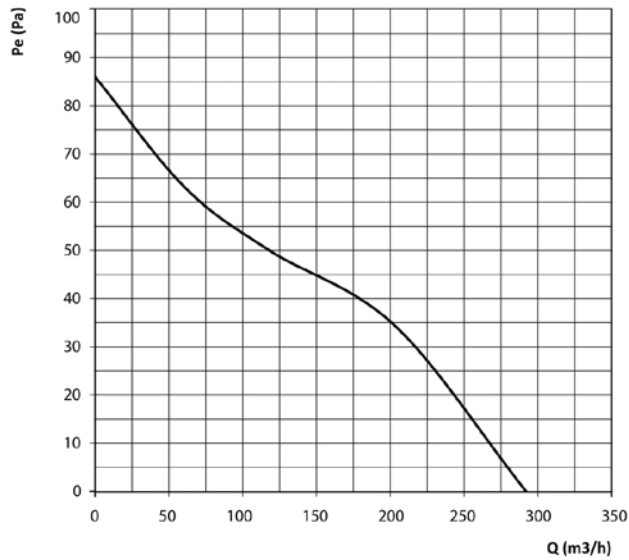

Accesorios



Rejilla decorativa



Persiana sobrepresión



Reguladores electrónicos de velocidad

EXTRACTORES AXIALES

26

HC	HGI	HCD	HCH	HCT
	 <p>Ventiladores helicoidales de gran diámetro</p>	 <p>Ventiladores helicoidales murales de pequeño diámetro</p>	 <p>Ventiladores helicoidales murales y tubulares de gran robustez</p>	 <p>Ventiladores helicoidales murales y tubulares de gran robustez</p>
Ventiladores helicoidales murales con motor IP-55 27	33	35	37	37
CJHCH	HCT/IMP-C	HCT/IMP	HFW	HTP
 <p>Unidades de ventilación helicoidales con caja aislada acústicamente</p>	 <p>Jet fans de gran alcance circulares unidireccionales o reversibles</p>	 <p>Jet fans de gran alcance unidireccionales o reversibles</p>	 <p>Ventiladores tubulares galvanizados en caliente</p>	 <p>Extractores helicoidales tubulares de alta presión</p>
49	52	54	57	62
HGT HGTX	HPX	HBA		
 <p>Ventiladores helicoidales tubulares de gran diámetro con motor directo</p>	 <p>Ventiladores helicoidales tubulares con motor exterior</p>	 <p>Ventiladores helicoidales tubulares bifurcados</p>		
75	102	105		

HC

Ventiladores helicoidales murales, con motor IP55

Ventiladores helicoidales murales, con hélice de plástico reforzada en fibra de vidrio

Ventilador:

- Marco soporte en chapa de acero
- Hélice en poliamida 6 reforzada con fibra de vidrio
- Rejilla de protección contra contactos según norma UNE-EN ISO 12499
- Modelos 71, 80, 90 y 100, la rejilla de protección se suministra como accesorio
- Dirección aire motor-hélice

Motor:

- Motores de eficiencia IE3 para potencias iguales o superiores a 0,75kW, excepto monofásicos, 2 velocidades y 8 polos.
- Motores clase F, con rodamientos a bolas, protección IP55, excepto modelos monofásicos desde el tamaño 45 hasta el tamaño 63, protección IP54. De 1 ó 2 velocidades según modelo
- Motor Multitensión, diseño especial válido para: 220/380V 60Hz, 254/440V 60Hz, 265/460V 60Hz, 277/480V 60Hz
- Temperatura de trabajo: -25°C.+ 60°C.

Acabado:

- Anticorrosivo en resina de poliéster polimerizada a 190 °C, previo desengrase con tratamiento nanotecnológico libre de fosfatos.

Bajo demanda:

- Conjunto motor, hélice y rejilla (versión F)
- Grupo motor hélice, versión G.
- Dirección aire hélice-motor.
- Bobinados especiales para diferentes tensiones.



HC



HC
71, 80,
90,100

Código de pedido

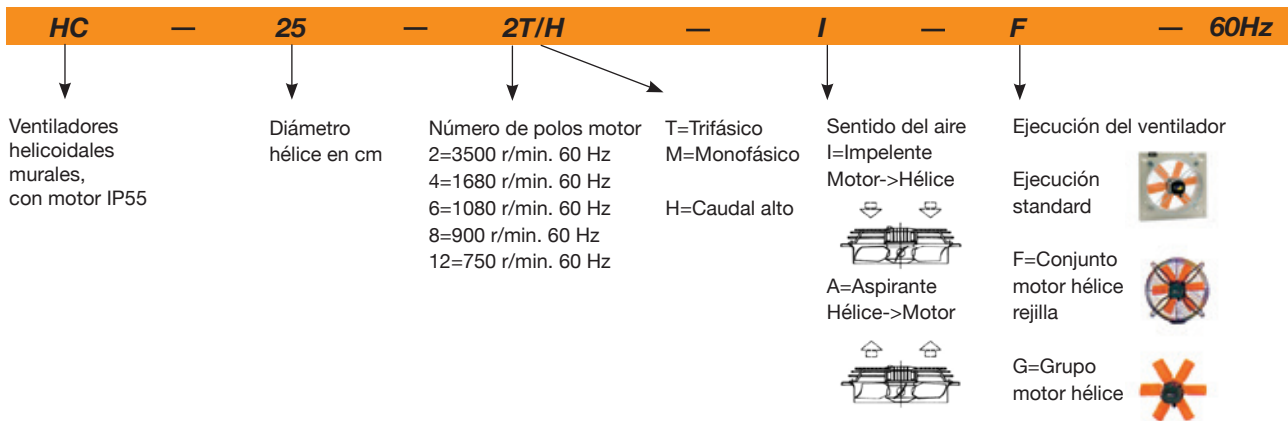

Características técnicas

60Hz

Modelo	Velocidad (r/min)	Intensidad máxima admisible (A)		Potencia instalada (kW)	Caudal máximo (m³/h)	Nivel presión sonora dB(A)	Peso aprox. (Kg)
		220-277V	380-480V				
HC-25-2T/H	2730	0,74	0,43	0,12	2200	64	5
HC-25-2M/H	2770	0,98		0,12	2200	64	5
HC-25-4T/H	1320	0,96	0,56	0,10	1300	51	5
HC-25-4M/H	1380	0,65		0,10	1300	51	5
HC-31-2T/H	2750	1,21	0,70	0,18	3650	72	6
HC-31-2M/H	2700	1,85		0,18	3600	72	6
HC-31-4T/H	1320	0,96	0,56	0,10	2400	54	6
HC-31-4M/H	1380	1,03		0,10	2400	54	6
HC-35-2T/H	2710	1,92	1,11	0,37	6050	76	8

Características técnicas

Modelo	Velocidad (r/min)	Intensidad máxima admisible (A)		Potencia instalada (kW)	Caudal máximo (m³/h)	Nivel presión sonora dB(A)	Peso aprox. (Kg)
		220-277V	380-480V				
HC-35-4T/H	1320	0,96	0,56	0,10	3550	58	7
HC-35-4M/H	1380	1,03		0,10	3550	58	7
HC-40-4T/H	1350	1,66	0,96	0,25	5200	63	10
HC-40-4M/H	1370	2,00		0,25	5200	63	10
HC-40-6T/H	900	1,51	0,87	0,25	3700	55	10
HC-40-6M/H	970	1,30		0,25	3700	55	10
HC-45-4T/H	1370	2,02	1,17	0,37	7300	66	14
HC-45-4M/H	1400	2,76		0,37	7300	66	14
HC-45-6T/H	900	1,51	0,87	0,25	5150	57	14
HC-45-6M/H	950	1,50		0,25	5150	57	14
HC-50-4T/H	1380	2,92	1,69	0,55	10200	69	18
HC-50-4M/H	1350	5,02		0,55	10200	69	18
HC-50-6T/H	900	2,24	1,30	0,37	6300	59	18
HC-50-6M/H	900	2,69		0,37	6300	59	18
HC-56-4T/H IE3	1400	4,03	2,32	1,10	13000	72	24
HC-56-4/8T/H	1440 / 710		2,9 / 1,3	1,10/0,25	13000/6500	72/57	24
HC-56-6T/H	900	2,24	1,30	0,37	8300	61	19
HC-56-6M/H	900	2,69		0,37	8300	61	19
HC-63-4T/H IE3	1400	4,03	2,32	1,10	16450	74	26
HC-63-4/8T/H	1440 / 710		2,9 / 1,3	1,10/0,25	16450/8225	74/59	26
HC-63-6T/H	900	2,24	1,30	0,37	12350	64	21
HC-63-6M/H	890	3,00		0,37	12350	64	21
HC-71-4T/H IE3	1430	5,96	3,44	1,50	22150	78	35
HC-71-4/8T/H	1420 / 700		3,5 / 1,5	1,50/0,37	22200/11100	78/63	35
HC-71-6T/H IE3	945	3,90	2,20	0,75	17300	66	36
HC-71-6M/H IE3	900	4,97		0,75	15600	65	36
HC-80-4T/H IE3	1445	10,96	6,33	3,00	33000	82	55
HC-80-4/8T/H	1430 / 710		6,5 / 2,3	3,0/0,60	33000/16500	82/67	53
HC-80-6T/H IE3	945	3,90	2,20	0,75	22000	71	45
HC-90-4T/H IE3	1440	14,10	8,12	4,00	43700	86	68
HC-90-4/8T/H	1430 / 710		8,2 / 2,9	4,00/0,80	43700/21850	86/69	74
HC-90-6T/H IE3	955	6,42	3,71	1,50	33300	76	60
HC-90-8T/H	695	3,53	2,04	0,55	19800	69	54
HC-100-4T/H IE3	1440		11,60	5,50	54000	88	85
HC-100-4/8T/H	1450 / 720		11,8 / 3,8	5,50/1,10	54000/27000	88/73	95
HC-100-6T/H IE3	955	6,42	3,71	1,50	37000	78	63
HC-100-8T/H	705	4,68	2,70	0,75	26950	72	61

Características acústicas

Los valores indicados, se determinan mediante medidas de nivel de presión y potencia sonora en dB(A) obtenidas en campo libre a una distancia equivalente a dos veces la envergadura del ventilador más el diámetro de la hélice, con un mínimo de 1.5 mts.

Espectro de potencia sonora Lw(A) en dB(A) por banda de frecuencia en Hz

Modelo	63	125	250	500	1000	2000	4000	8000	Modelo	63	125	250	500	1000	2000	4000	8000
25-2T/H	38	48	65	65	73	69	62	53	63-4/8T/H	43	60	73	80	85	86	81	74
25-4T/H	25	35	52	52	60	56	49	40	63-6T/H	33	50	63	70	75	76	71	64
31-2T/H	46	56	73	73	81	77	70	61	71-4T/H	47	64	77	84	89	90	85	78
31-4T/H	28	38	55	55	63	59	52	43	71-4/8T/H	47	64	77	84	89	90	85	78
35-2T/H	50	60	77	77	85	81	74	65	71-6T/H	35	52	65	72	77	78	73	66
35-4T/H	32	42	59	59	67	63	56	47	80-4T/H	60	81	88	93	96	92	85	74
40-4T/H	28	45	57	65	70	70	66	59	80-4/8T/H	60	81	88	93	96	92	85	74
40-6T/H	20	37	49	57	62	62	58	51	80-6T/H	49	70	77	82	85	81	74	63
45-4T/H	33	50	63	70	75	76	71	64	90-4T/H	64	85	92	97	100	96	89	78
45-6T/H	24	41	54	61	66	67	62	55	90-4/8T/H	64	85	92	97	100	96	89	78
50-4T/H	36	53	66	73	78	79	74	67	90-6T/H	54	75	82	87	90	86	79	68
50-6T/H	26	43	56	63	68	69	64	57	90-8T/H	47	68	75	80	83	79	72	61
56-4T/H	39	56	69	76	81	82	77	70	100-4T/H	68	88	96	101	103	100	93	82
56-4/8T/H	39	56	69	76	81	82	77	70	100-4/8T/H	68	88	96	101	103	100	93	82
56-6T/H	28	45	58	65	70	71	66	59	100-6T/H	58	78	86	91	93	90	83	72
63-4T/H	43	60	73	80	85	86	81	74	100-8T/H	52	72	80	85	87	84	77	66

Dimensiones mm

HC 25...63

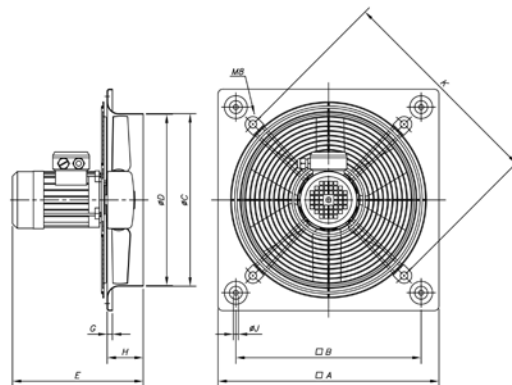

Modelo	A	B	ØC	ØD	E	G	H	ØJ	K
HC-25	330	275	262	260	241	11	56	8,5	310
HC-31-2	400	336	310,5	308	264,5	11	65	8,5	380
HC-31-4	400	336	310,5	308	245,5	11	65	8,5	380
HC-35-2	465	390	362,5	360	310	11	76	10,5	450
HC-35-4	465	390	362,5	360	261	11	76	10,5	450
HC-40-4.../H	532	452	412,5	410	332	11	97,5	10,5	500
HC-40-6.../H	532	452	412,5	410	332	11	97,5	10,5	500
HC-45-4.../H	596	504	462,5	460	339	11	105	10,5	560
HC-45-6.../H	596	504	462,5	460	339	11	105	10,5	560
HC-50-4T/H	665	562	516,5	514	376	11	115	10,5	640
HC-50-4M/H	665	562	516,5	514	376	11	115	10,5	640
HC-50-6.../H	665	562	516,5	514	336	11	115	10,5	640
HC-56-4T/H	710	630	563	560	374	15	115	10,5	721
HC-56-6.../H	710	630	563	560	351	15	115	10,5	721
HC-63-4T/H	800	710	638	635	399	15	140	10,5	820
HC-63-6.../H	800	710	638	635	376	15	140	10,5	820

HC 71...100

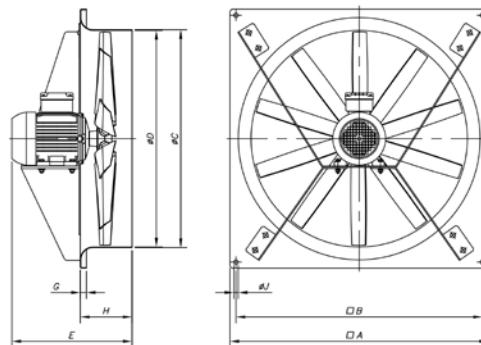

Modelo	A	B	ØC	ØD	E	G	H	ØJ
HC-71-4T/H	850	810	715	711	395	20	170	14,5
HC-71-6T/H	850	810	715	711	395	20	170	14,5
HC-80-4T/H	970	910	801	797	500	20	210	14,5
HC-80-6T/H	970	910	801	797	458	20	210	14,5
HC-90-4T/H	1170	1110	918	914	511	20	210	14,5
HC-90-6T/H	1170	1110	918	914	500	20	210	14,5
HC-90-8T/H	1170	1110	918	914	455	20	210	14,5
HC-100-4T/H	1170	1110	1003	999	548	20	220	14,5
HC-100-6T/H	1170	1110	1003	999	498	20	220	14,5
HC-100-8T/H	1170	1110	1003	999	498	20	220	14,5

Curvas características

Q= Caudal en m³/h, m³/s y cfm.

Pe= Presión estática en mmH₂O, Pa e inwg.

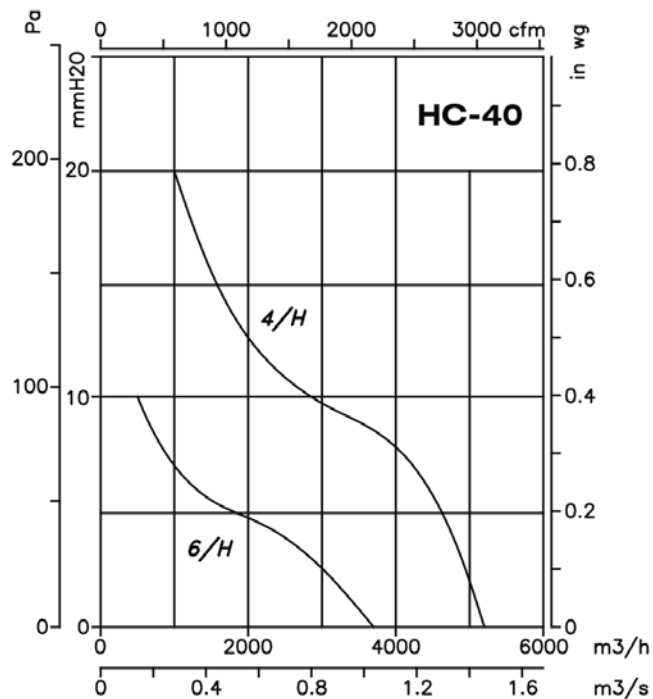
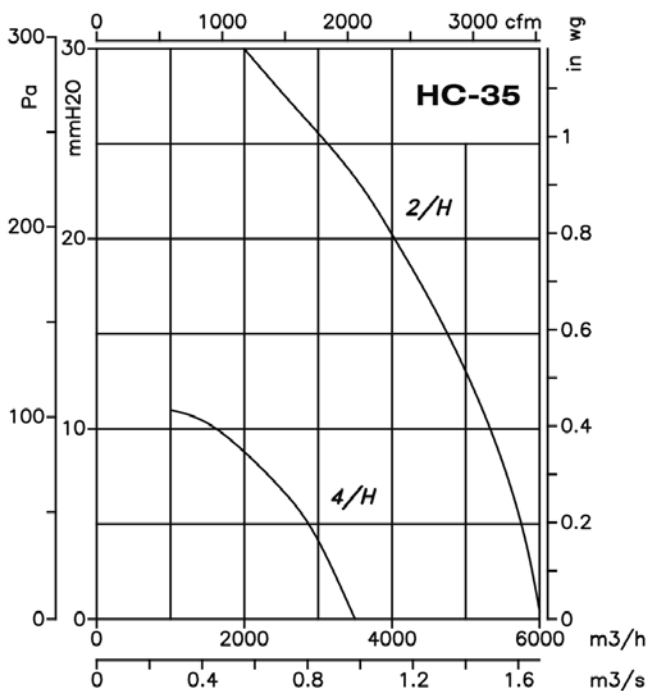
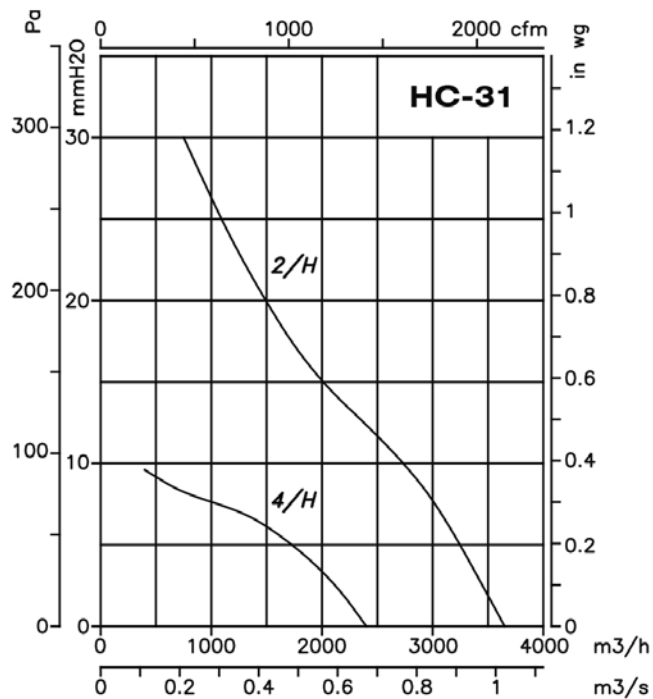
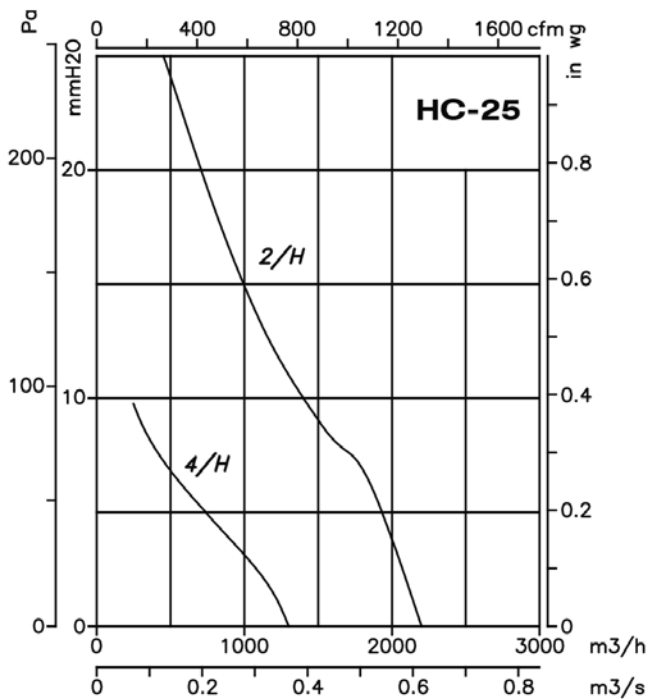

Curvas características

Q= Caudal en m³/h, m³/s y cfm.

Pe= Presión estática en mmH₂O, Pa e inwg.

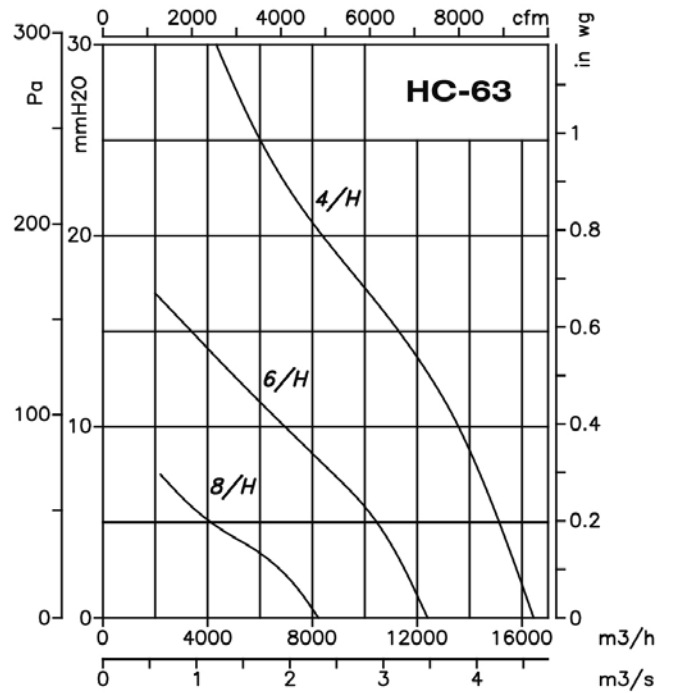
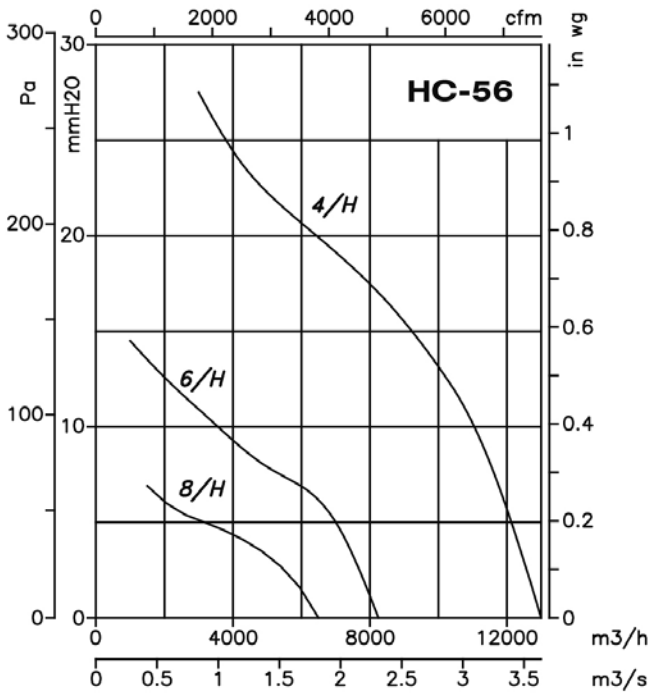
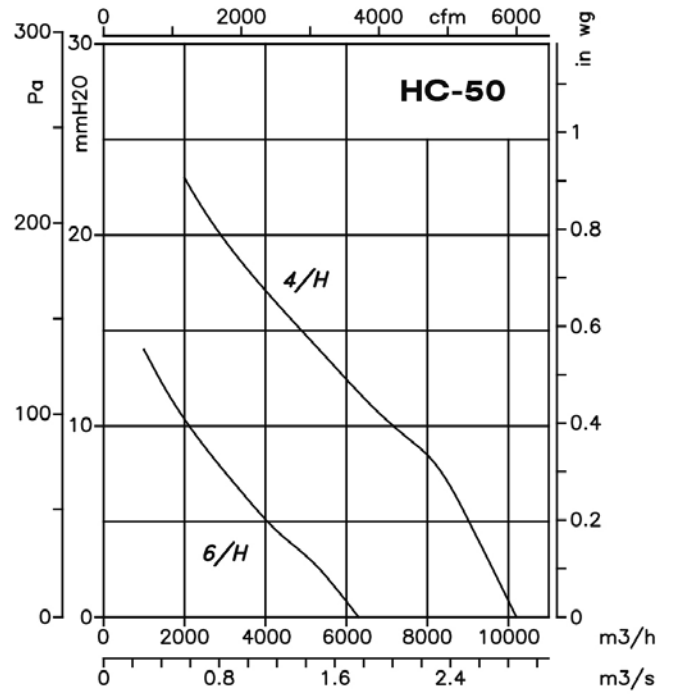
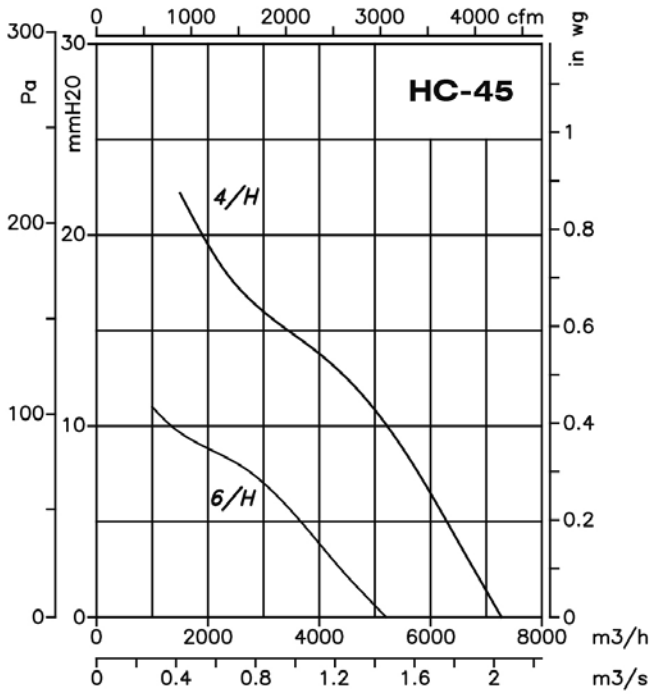

Curvas características

Q= Caudal en m³/h, m³/s y cfm.

Pe= Presión estática en mmH₂O, Pa e inwg.

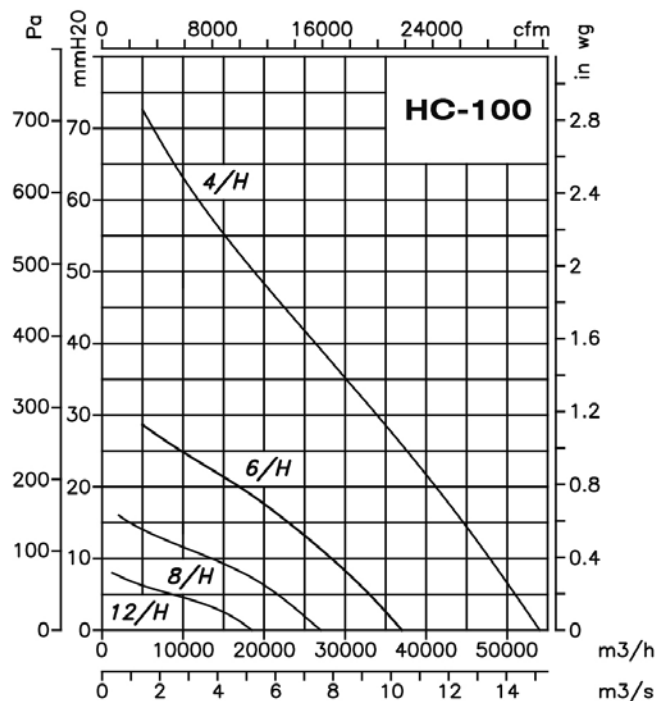
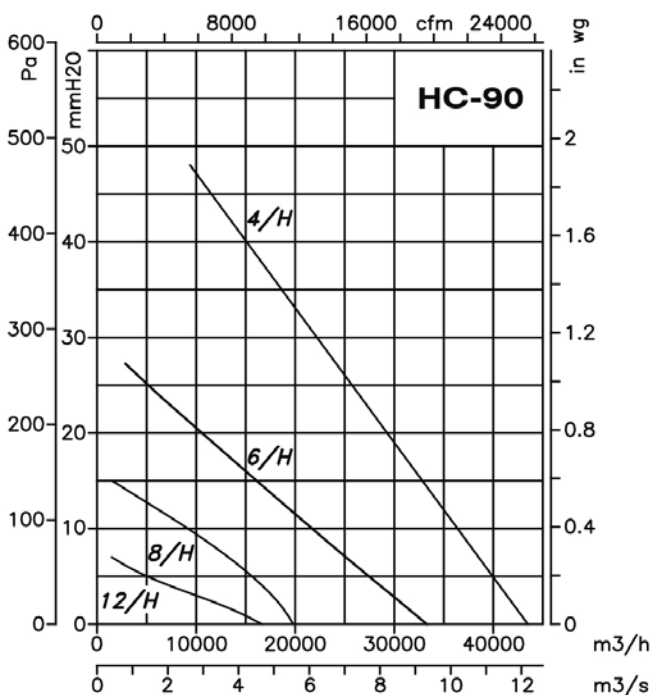
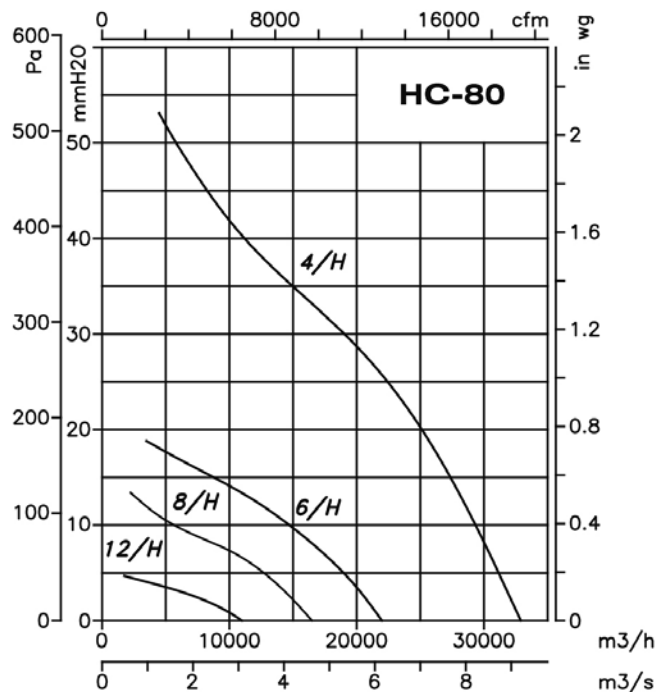
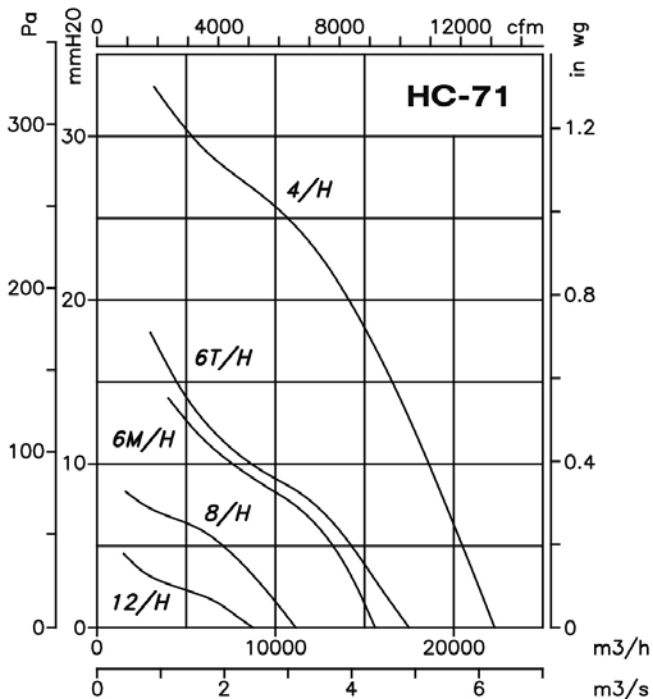

Accesorios



HGI



Ventiladores helicoidales de gran diámetro

Ventiladores helicoidales murales diseñados para grandes caudales de aire a baja velocidad, con persiana de apertura automática.

Ventilador:

- Marco soporte en chapa de acero
- Estructura en acero galvanizado
- Hélice en chapa de acero galvanizado
- Rejilla de protección contra contactos según norma UNE-EN ISO 12499:2010
- Especialmente diseñados en aplicaciones de granjas e invernaderos
- Dirección aire motor-hélice

Motor:

- Motores de eficiencia IE3 para potencias iguales o superiores a 0,75kW, excepto monofásicos, 2 velocidades y 8 polos.

- Motores clase F, con rodamientos a bolas, protección IP55
- Motor Multitensión, diseño especial válido para: 220/380V 60Hz, 254/440V 60Hz, 265/460V 60Hz, 277/480V 60Hz
- Temperatura de trabajo : -25°C+ 50°C

Acabado:

- Anticorrosivo en chapa de acero galvanizado

Bajo demanda:

- Sin persiana y con rejilla de protección en el lado de impulsión
- Bobinados especiales para diferentes tensiones

Código de pedido

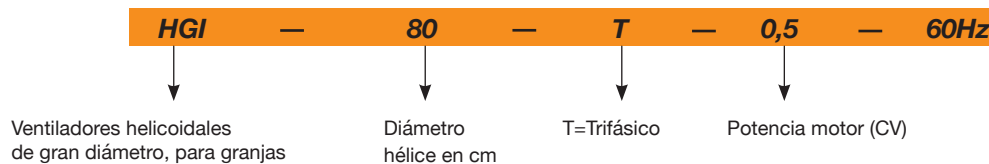

60Hz

Características técnicas

Modelo	Velocidad (r/min)	Intensidad máxima admisible (A)		Potencia instalada (kW)	Caudal máximo (m³/h)	Nivel presión sonora dB(A)	Peso aprox. (Kg)
		220-277V	380-480V				
HGI-80-T-0,5	570	1,70	1,00	0,37	16000	63	48
HGI-80-T-0,75	630	2,40	1,40	0,55	18000	65	49
HGI-100-T-0,5	398	2,10	1,20	0,37	25000	62	63
HGI-100-T-0,75	472	2,80	1,60	0,55	29000	65	64
HGI-100-T-1	503	3,50	2,00	0,75	32000	66	66
HGI-125-T-1	437	3,50	2,00	0,75	38000	69	87
HGI-125-T-1,5	485	4,80	2,80	1,10	43000	72	90

Características acústicas

Los valores indicados, se determinan mediante medidas de nivel de presión y potencia sonora en dB(A) obtenidas en campo libre a una distancia equivalente a dos veces la envergadura del ventilador más el diámetro de la hélice, con un mínimo de 1,5 mts.

Espectro de potencia sonora Lw(A) en dB(A) banda de frecuencia en [Hz]

Modelo	63	125	250	500	1000	2000	4000	8000	Modelo	63	125	250	500	1000	2000	4000	8000
HGI-80-T-0,5	57	64	72	74	72	69	66	58	HGI-100-T-1	61	69	77	79	77	74	70	63
HGI-80-T-0,75	59	66	74	76	74	71	68	60	HGI-125-T-1	64	72	80	82	80	77	73	66
HGI-100-T-0,5	57	65	73	75	73	70	66	59	HGI-125-T-1,5	67	75	83	85	83	80	76	69
HGI-100-T-0,75	60	68	76	78	76	73	69	62									

Curvas características

Q= Caudal en m³/h, m³/s y cfm. Pe= Presión estática en mmH₂O, Pa e inwg.

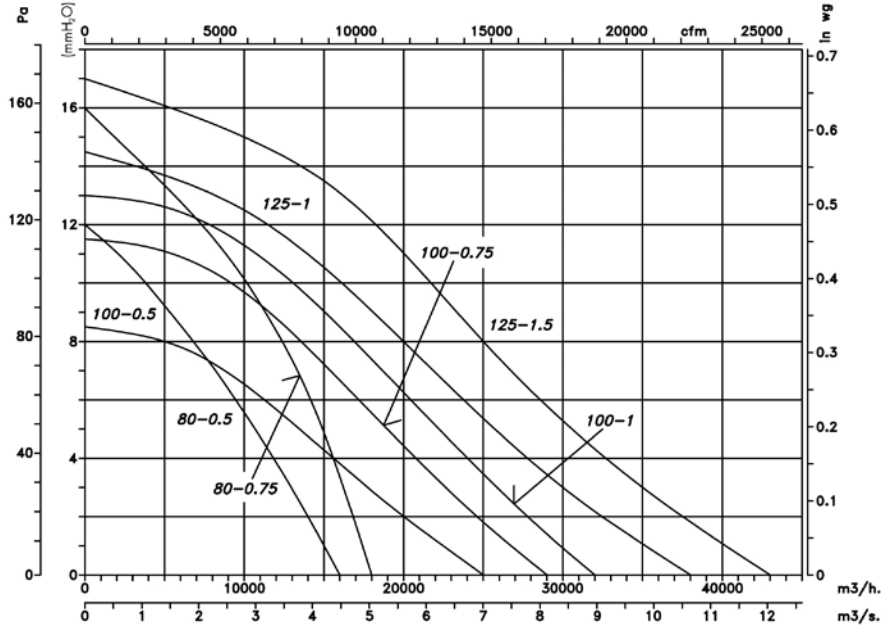

Dimensiones mm

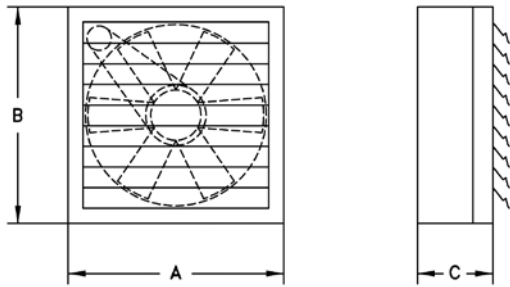

Modelo	A	B	C
HGI-80	925	925	427
HGI-100	1125	1125	447
HGI-125	1375	1375	480

Accesorios



INT

VSD3/A-RFT
VSD1/A-RFM

CUADROS

SI

HCD

Ventiladores helicoidales murales, de pequeño diámetro

Ventiladores helicoidales murales, con hélice en chapa de aluminio, motores de espira de sombra y cable de conexión incorporado.



Ventilador:

- Marco soporte en chapa de acero
- Hélice en chapa de aluminio
- Rejilla de protección contra contactos según norma UNE-EN ISO 12499
- Dirección aire motor-hélice

Motor:

- Motores clase B, con cojinetes de fricción autolubricados, protección IP44, excepto modelo 40 equipado con motor clase F, con rodamientos a bolas, protección IP54
- Monofásicos 110/120V. 60Hz o 220V 60Hz
- Temperatura de trabajo: -25°C.+ 50°C

Acabado:

- Anticorrosivo en resina de poliéster polimerizada a 190 °C, previo desengrase con tratamiento nanotecnológico libre de fosfatos.

Bajo demanda:

- Bobinados especiales para diferentes tensiones

Código de pedido

HCD — 20 — 4M — 1 — 60Hz

Ventiladores helicoidales murales, de pequeño diámetro

Diámetro hélice en cm

Número de polos motor
4=1680 r/min. 60 Hz

M=Monofásico

1: Alimentación 110V 60Hz
2: Alimentación 220V 60Hz

Características técnicas

60Hz

Modelo	Velocidad (r/min)	Intensidad máxima admisible (A)		Potencia absorb. desc. Libre (W)	Caudal máximo (m³/h)	Nivel presión sonora dB(A)	Peso aprox. (Kg)
		110V	220V				
HCD-20-4M	1580	0,45	0,21	36	560	38	1,15
HCD-25-4M	1550	0,63	0,25	50	960	43	1,60
HCD-30-4M	1550	0,76	0,51	76	1350	48	2,15
HCD-35-4M	1460	1,53	0,80	115	1820	53	6,20
HCD-40-4M	1550	2,20	1,10	180	3100	57	7,20

Dimensiones mm

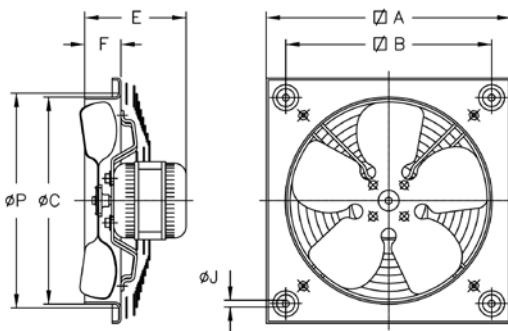

Modelo	∅A	∅B	∅C	E	F	∅J	∅P
HCD-20	266	222	211	104,5	34	9	240
HCD-25	330	275	262	105,5	56	10,5	290
HCD-30	400	336	311	153	75	10,5	348
HCD-35	465	390	363	166	86	10,5	410
HCD-40	532	452	413	276	97,5	10,5	460

Curvas características

Q= Caudal en m³/h, m³/s y cfm.

Pe= Presión estática en mmH₂O, Pa e inwg.

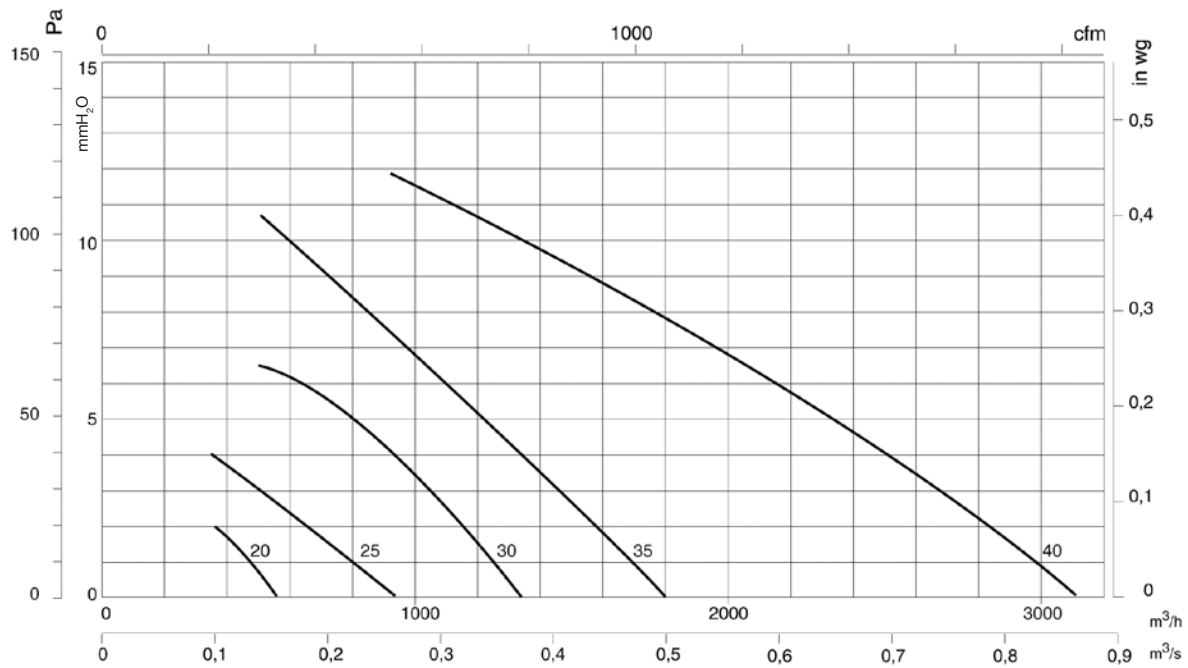

Accesorios

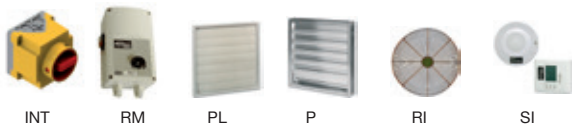

INT

RM

PL

P

RI

SI

HCH HCT

Ventiladores helicoidales murales o tubulares, de gran robustez

Ventiladores helicoidales murales o tubulares, versión PL equipados con hélice de plástico y versión AL equipados con hélice de aluminio.

Ventilador:

- Dirección aire motor-hélice
- Hélices versión PL en poliamida 6 reforzada con fibra de vidrio y versión AL en fundición de aluminio. Los modelos HCT-40-2T y HCT-45-2T sólo en versión AL
- HCH: Aro soporte en chapa de acero
- HCT: Envoltente tubular en chapa de acero con caja de bornes exterior

Motor:

- Motores de eficiencia IE3 para potencias iguales o superiores a 0,75kW, excepto monofásicos, 2 velocidades y 8 polos.
- Motores clase F, con rodamientos a bolas, protección IP55, excepto modelos monofásicos desde el tamaño 45 hasta el tamaño 56, protección IP54. De 1 ó 2 velocidades según modelo
- Motor Multitensión, diseño especial válido para: 220/380V 60Hz, 254/440V 60Hz, 265/460V 60Hz, 277/480V 60Hz
- Temperatura de trabajo : -25°C.+ 50°C.

Acabado:

- Anticorrosivo en resina de poliéster polimerizada a 190 °C, previo desengrase con tratamiento nanotecnológico libre de fosfatos.

Bajo demanda:

- Dirección aire hélice-motor.
- Hélices reversibles 100%.
- Bobinados especiales para diferentes tensiones.
- Certificación ATEX Categoría 2



HCH



HCT

Código de pedido

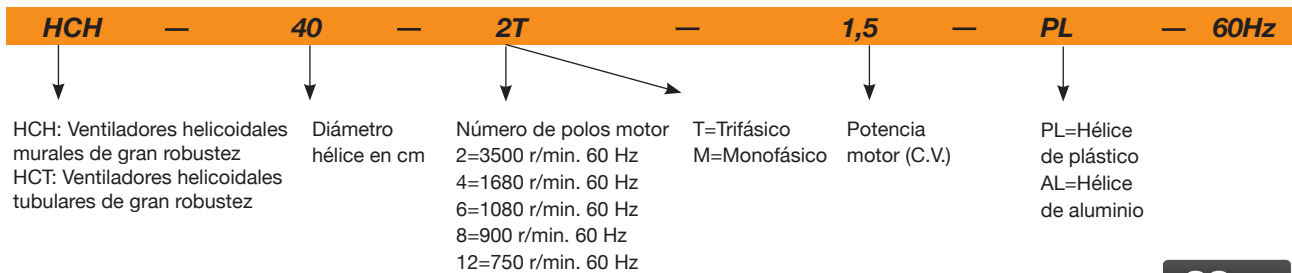

Características técnicas

60Hz

Modelo	Velocidad (r/min)	Intensidad máxima admisible (A)		Potencia instalada (kW)	Caudal máximo (m³/h)	Nivel presión sonora dB(A)	Peso aprox.	
		220-277V	380-480V				HCH	HCT
HCT 25-2T	3204	0,64	0,37	0,09	1950	64		7
HCT 25-2M	3312	0,79		0,09	1950	64		7
HCT 25-4T	1584	0,65	0,38	0,09	1000	50		7
HCT 25-4M	1656	0,65		0,10	1000	50		7
HCT 31-2T	3300	1,21	0,70	0,18	2900	70		8
HCT 31-2M	3336	1,42		0,18	2900	70		8
HCT 31-4T	1584	0,65	0,38	0,09	1550	52		8
HCT 31-4M	1656	0,65		0,10	1550	52		8
HCH HCT 35-2T	3252	1,92	1,11	0,37	5750	77	9	12
HCT 35-2M	3336	2,53		0,37	5750	77		12
HCH HCT 35-4T	1584	0,65	0,38	0,09	3100	59	7	10
HCT 35-4M	1656	0,65		0,10	3100	59		10
HCH HCT 40-2T-1,5	3432	4,20	2,40	1,10	8800	84	17	25
HCH HCT 40-4T-0,33	1620	1,66	0,96	0,25	5150	64	13	21
HCT 45-2T-2	3324	5,44	3,13	1,50	10650	86		31
HCT 45-2T-3	3462	7,77	4,47	2,20	12750	88		34
HCT 45-2/4T-3	3492 / 1704		5,00 / 1,60	2,20 / 0,60	12750/6375	88/73		33
HCH HCT 45-4T-0,5	1644	2,02	1,17	0,37	7100	68	15	24
HCH HCT 45-4M-0,5	1680	2,76		0,37	7100	68	15	24
HCH 45-6T-0,33	1080	1,51	0,87	0,25	4750	55	14	
HCH 45-6M-0,33	1140	1,30		0,25	4750	55	15	
HCT 50-4T-0,75	1656	2,92	1,69	0,55	10400	70		28
HCH HCT 56-4T-0,75	1656	2,92	1,69	0,55	11050	72	21	33
HCH HCT 56-4M-0,75	1740	4,40		0,55	11050	72	21	33

Características técnicas

Modelo	Velocidad (r/min)	Intensidad máxima admisible (A)		Potencia instalada (kW)	Caudal máximo (m³/h)	Nivel presión sonora dB(A)	Peso aprox.	
		220-277V	380-480V				HCH	HCT
HCH HCT 56-4T-1	1692	3,10	1,79	0,75	12950	73	22	34
HCH HCT 56-4/8T-1	1716 / 852		2,00 / 0,90	0,75 / 0,20	12950/6475	73/58	23	35
HCH HCT 56-4T-1,5	1680	4,03	2,32	1,10	14000	74	26	37
HCH HCT 56-4/8T-1,5	1728 / 852		2,90 / 1,30	1,10 / 0,25	14000/7000	74/59	24	35
HCH HCT 56-4T-2	1716	5,96	3,44	1,50	15300	75	28	39
HCH HCT 56-4/8T-2	1704 / 840		3,50 / 1,50	1,50 / 0,37	15300/7650	75/60	28	39
HCH HCT 56-6T-0,33	1080	1,51	0,87	0,25	8500	61	18	30
HCH HCT 56-6M-0,33	1140	1,85		0,25	8400	61	19	31
HCH HCT 56-6T-0,5	1080	2,24	1,30	0,37	9300	61	20	32
HCH HCT 56-6T-0,75	1080	2,99	1,73	0,55	10000	62	22	34
HCH HCT 63-4T-1	1692	3,10	1,79	0,75	14150	73	27	42
HCH HCT 63-4/8T-1	1716 / 852		2,00 / 0,90	0,75 / 0,20	14150/7075	73/58	27	43
HCH HCT 63-4T-1,5	1680	4,03	2,32	1,10	17000	74	30	45
HCH HCT 63-4/8T-1,5	1728 / 852		2,90 / 1,30	1,10 / 0,25	17000/8500	74/59	29	44
HCH HCT 63-4T-2	1716	5,96	3,44	1,50	18900	75	33	48
HCH HCT 63-4/8T-2	1704 / 840		3,50 / 1,50	1,50 / 0,37	18900/9450	75/60	32	48
HCH HCT 63-4T-3	1734	8,36	4,83	2,20	22100	76	41	57
HCH HCT 63-4/8T-3	1716 / 852		4,90 / 1,70	2,20 / 0,45	22100/11050	76/61	38	54
HCH HCT 63-4T-4	1734	10,96	6,33	3,00	25400	77	43	59
HCH HCT 63-4/8T-4	1716 / 852		6,50 / 2,30	3,00 / 0,60	25400/12700	77/62	42	57
HCH HCT 63-6T-0,5	1080	2,24	1,30	0,37	12150	64	25	40
HCH HCT 63-6M-0,5	1080	2,69		0,37	12150	64	25	40
HCH HCT 63-6T-0,75	1080	2,99	1,73	0,55	12750	65	27	42
HCH HCT 63-6T-1	1134	3,90	2,20	0,75	13800	66	33	48
HCH HCT 63-6/12T-1	1122 / 522		2,20 / 0,87	0,75 / 0,15	13800/6900	66/51	32	47
HCH HCT 71-4T-1,5	1680	4,03	2,32	1,10	19750	78	33	52
HCH HCT 71-4/8T-1,5	1728 / 852		2,90 / 1,30	1,10 / 0,25	19600/9800	78/63	32	51
HCH HCT 71-4T-2	1716	5,96	3,44	1,50	21100	79	36	55
HCH HCT 71-4/8T-2	1704 / 840		3,50 / 1,50	1,50 / 0,37	21100/10550	79/64	35	54
HCH HCT 71-4T-3	1734	8,36	4,83	2,20	23950	81	45	64
HCH HCT 71-4/8T-3	1716 / 852		4,90 / 1,70	2,20 / 0,45	24150/12075	81/66	42	61
HCH HCT 71-4T-4	1734	10,96	6,33	3,00	29400	82	47	66
HCH HCT 71-4/8T-4	1716 / 852		6,50 / 2,30	3,00 / 0,60	29550/14775	82/67	46	64
HCH HCT 71-6T-0,75	1080	2,99	1,73	0,55	15150	67	29	49
HCH HCT 71-6M-0,75	1080	3,84		0,55	15150	67	29	49
HCH HCT 71-6T-1	1134	3,90	2,20	0,75	17250	68	36	55
HCH HCT 71-6/12T-1	1122 / 522		2,20 / 0,87	0,75 / 0,15	17150/8575	68/53	35	54
HCH HCT 71-6T-1,5	1134	4,88	2,82	1,10	20950	69	38	57
HCH HCT 71-6/12T-1,5	1140 / 564		3,00 / 1,15	1,10 / 0,18	20950/10475	69/54	37	56
HCH HCT 80-4T-3	1734	8,36	4,83	2,20	28000	82	53	72
HCH HCT 80-4/8T-3	1716 / 852		4,90 / 1,70	2,20 / 0,45	28000/14000	82/67	50	69
HCH HCT 80-4T-4	1734	10,96	6,33	3,00	32700	83	55	74
HCH HCT 80-4/8T-4	1716 / 852		6,50 / 2,30	3,00 / 0,60	32700/16350	83/68	54	73
HCH HCT 80-4T-5,5	1728	14,10	8,12	4,00	37200	84	60	79
HCH HCT 80-4/8T-5,5	1716 / 852		8,20 / 2,90	4,00 / 0,80	37200/18600	84/69	66	85
HCH HCT 80-6T-1	1134	3,90	2,20	0,75	20600	71	44	64
HCH HCT 80-6/12T-1	1122 / 522		2,20 / 0,87	0,75 / 0,15	20600/10300	71/56	43	63
HCH HCT 80-6T-1,5	1134	4,88	2,82	1,10	24250	72	46	66
HCH HCT 80-6/12T-1,5	1140 / 564		3,00 / 1,15	1,10 / 0,18	24250/12125	72/57	45	65
HCH HCT 80-6T-2	1146	6,42	3,71	1,50	28000	73	52	71
HCH HCT 80-6/12T-2	1164 / 564		4,60 / 1,90	1,50 / 0,25	28000/14000	73/58	62	81
HCH HCT 80-6T-3	1146	9,30	5,30	2,20	32500	74	57	76
HCH HCT 80-6/12T-3	1128 / 564		5,60 / 2,20	2,20 / 0,37	32500/16250	74/59	62	81
HCH HCT 80-8T-0,5	840	2,77	1,60	0,37	16600	69	43	63
HCH HCT 80-8T-0,75	834	3,53	2,04	0,55	19600	70	45	65
HCH HCT 80-8T-1	846	4,68	2,70	0,75	22150	71	50	69
HCH HCT 90-4T-4	1734	10,96	6,33	3,00	37750	87	62	90
HCH HCT 90-4/8T-4	1716 / 852		6,50 / 2,30	3,00 / 0,60	37750/18875	87/72	61	88
HCH HCT 90-4T-5,5	1728	14,10	8,12	4,00	41850	89	67	95
HCH HCT 90-4/8T-5,5	1716 / 852		8,20 / 2,90	4,00 / 0,80	41850/20925	89/74	73	101
HCH HCT 90-4T-7,5	1728		11,60	5,50	47000	91	83	109
HCH HCT 90-4/8T-7,5	1740 / 864		11,80 / 3,80	5,50 / 1,10	47000/23500	91/76	93	119
HCH HCT 90-4T-10	1746		14,20	7,50	53000	92	94	120
HCH HCT 90-4T-10	1758		13,90	7,50	53000	92	110	136
HCH HCT 90-4/8T-10	1752 / 870		15,30 / 5,40	7,50 / 1,50	53000/26500	92/77	98	124
HCH HCT 90-6T-2	1146	6,42	3,71	1,50	30000	77	59	87
HCH HCT 90-6/12T-2	1164 / 564		4,60 / 1,90	1,50 / 0,25	30000/15000	77/62	69	97

Características técnicas

Modelo	Velocidad (r/min)	Intensidad máxima admisible (A)		Potencia instalada (kW)	Caudal máximo (m³/h)	Nivel presión sonora dB(A)	Peso aprox.	
		220-277V	380-480V				HCH	HCT
HCH HCT 90-6T-3	1146	11,46	5,30	2,20	35000	78	64	92
HCH HCT 90-6/12T-3	1128 / 564		5,60 / 2,20	2,20 / 0,37	35000/17500	78/63	69	97
HCH HCT 90-6T-4	1152	12,70	7,30	3,00	40000	79	88	114
HCH HCT 90-6/12T-4	1152 / 576		9,00 / 3,50	3,00 / 0,55	40000/20000	79/64	87	113
HCH HCT 90-8T-1	846	4,68	2,70	0,75	22400	71	57	85
HCH HCT 90-8T-1,5	846	5,63	3,25	1,10	24150	72	60	88
HCH HCT 90-8T-2	846	7,10	4,10	1,50	26300	73	71	99
HCH HCT 90-8T-3	846	9,53	5,50	2,20	30150	74	98	124
HCH HCT 100-4T-7,5	1728		11,60	5,50	52500	92	91	121
HCH HCT 100-4/8T-7,5	1740 / 864		11,80 / 3,80	5,50 / 1,10	52500/26250	92/77	101	128
HCH HCT 100-4T-10	1746		14,20	7,50	58500	93	102	131
HCH HCT 100-4T-10	1758		13,90	7,50	58500	93	118	147
HCH HCT 100-4/8T-10	1752 / 870		15,30 / 5,40	7,50 / 1,50	58500/29250	93/78	106	135
HCH HCT 100-4T-15	1752		20,20	11,00	68000	94	125	160
HCH HCT 100-4T-15	1764		20,90	11,00	68000	94	150	185
HCH HCT 100-4/8T-15	1764 / 870		23,20 / 8,70	11,00 / 2,80	68000/34000	94/79	125	160
HCH HCT 100-4T-20	1752		27,50	15,00	71850	95	144	179
HCH HCT 100-4T-20	1758		27,90	15,00	71850	95	161	196
HCH HCT 100-4/8T-20	1752 / 870		31,72 / 11,75	15,00 / 3,80	72450/36225	95/80	140	175
HCH HCT 100-6T-3	1146	9,30	5,30	2,20	40500	82	72	103
HCH HCT 100-6/12T-3	1128 / 564		5,60 / 2,20	2,20 / 0,37	40500/20250	82/67	77	108
HCH HCT 100-6T-4	1152	12,70	7,30	3,00	46950	83	96	125
HCH HCT 100-6/12T-4	1152 / 576		9,00 / 3,50	3,00 / 0,55	46950/23475	83/68	95	124
HCH HCT 100-6T-5,5	1152	16,50	9,46	4,00	52000	84	104	133
HCH HCT 100-6/12T-5,5	1164 / 576		4,00 / 11,00	4,00 / 0,65	52000/26000	84/69	100	129
HCH HCT 100-8T-1,5	846	5,63	3,25	1,10	32500	76	67	99
HCH HCT 100-8T-2	846	7,10	4,10	1,50	33850	77	79	110
HCH HCT 100-8T-3	846	9,53	5,50	2,20	35150	77	106	135
HCH HCT 100-8T-4	846	12,82	7,40	3,00	37800	78	114	143

Características acústicas

Los valores indicados, se determinan mediante medidas de nivel de presión y potencia sonora en dB(A) obtenidas en campo libre a una distancia equivalente a dos veces la envergadura del ventilador más el diámetro de la hélice, con un mínimo de 1,5 mts.

Espectro de potencia sonora Lw(A) en dB(A) por banda de frecuencia en Hz

Modelo	63	125	250	500	1000	2000	4000	8000	Modelo	63	125	250	500	1000	2000	4000	8000
25-2	35	50	69	68	69	68	63	54	71-4-1,5	55	75	83	88	90	87	80	69
25-4	21	36	55	54	55	54	49	40	71-8-1,5 (2v)	40	60	68	73	75	72	65	54
31-2	41	56	75	74	75	74	69	60	71-4-2	56	76	84	89	91	88	81	70
31-4	23	38	57	56	57	56	51	42	71-8-2 (2v)	41	61	69	74	76	73	66	55
35-2	48	63	82	81	82	81	76	67	71-4-3	58	78	86	91	93	90	83	72
35-4	30	45	64	63	64	63	58	49	71-8-3 (2v)	43	63	71	76	78	75	68	57
40-2	55	70	89	88	89	88	83	74	71-4-4	59	79	87	92	94	91	84	73
40-4	35	50	69	68	69	68	63	54	71-8-4 (2v)	44	64	72	77	79	76	69	58
45-2-2	51	68	80	88	93	93	89	82	71-6-0,75	44	64	72	77	79	76	69	58
45-2-3	53	70	82	90	95	95	91	84	71-6-1	45	65	73	78	80	77	70	59
45-4-3 (2v)	38	55	67	75	80	80	76	69	71-12-1 (2v)	30	50	58	63	65	62	55	44
45-4-0,5	33	50	62	70	75	75	71	64	71-6-1,5	46	66	74	79	81	78	71	60
45-6	20	37	49	57	62	62	58	51	71-12-1,5 (2v)	31	51	59	64	66	63	56	45
50-4	37	54	67	74	79	80	75	68	80-4-3	59	79	87	92	94	91	84	73
56-4-0,75	47	67	75	80	82	79	72	61	80-8-3 (2v)	44	64	72	77	79	76	69	58
56-4-1	48	68	76	81	83	80	73	62	80-4-4	60	80	88	93	95	92	85	74
56-8-1 (2v)	33	53	61	66	68	65	58	47	80-8-4 (2v)	45	65	73	78	80	77	70	59
56-4-1,5	49	69	77	82	84	81	74	63	80-4-5,5	61	81	89	94	96	93	86	75
56-8-1,5 (2v)	34	54	62	67	69	66	59	48	80-8-5,5 (2v)	46	66	74	79	81	78	71	60
56-4-2	50	70	78	83	85	82	75	64	80-6-1	48	68	76	81	83	80	73	62
56-8-2 (2v)	35	55	63	68	70	67	60	49	80-12-1 (2v)	33	53	61	66	68	65	58	47
56-6-0,33	36	56	64	69	71	68	61	50	80-6-1,5	49	69	77	82	84	81	74	63
56-6-0,5	36	56	64	69	71	68	61	50	80-12-1,5 (2v)	34	54	62	67	69	66	59	48
56-6-0,75	37	57	65	70	72	69	62	51	80-6-2	50	70	78	83	85	82	75	64
63-4-1	50	70	78	83	85	82	75	64	80-12-2 (2v)	35	55	63	68	70	67	60	49
63-8-1 (2v)	35	55	63	68	70	67	60	49	80-6-3	51	71	79	84	86	83	76	65
63-4-1,5	51	71	79	84	86	83	76	65	80-12-3 (2v)	36	56	64	69	71	68	61	50
63-8-1,5 (2v)	36	56	64	69	71	68	61	50	80-8-0,5	46	66	74	79	81	78	71	60
63-4-2	52	72	80	85	87	84	77	66	80-8-0,75	47	67	75	80	82	79	72	61
63-8-2 (2v)	37	57	65	70	72	69	62	51	80-8-1	48	68	76	81	83	80	73	62
63-4-3	53	73	81	86	88	85	78	67	90-4-4	65	86	93	98	101	97	90	79
63-8-3 (2v)	38	58	66	71	73	70	63	52	90-8-4 (2v)	50	71	78	83	86	82	75	64
63-4-4	54	74	82	87	89	86	79	68	90-4-5,5	67	88	95	100	103	99	92	81
63-8-4 (2v)	39	59	67	72	74	71	64	53	90-8-5,5 (2v)	52	73	80	85	88	84	77	66
63-6-0,5	41	61	69	74	76	73	66	55	90-4-7,5	69	90	97	102	105	101	94	83
63-6-0,75	42	62	70	75	77	74	67	56	90-8-7,5 (2v)	54	75	82	87	90	86	79	68
63-6-1	43	63	71	76	78	75	68	57	90-4-10	70	91	98	103	106	102	95	84
63-12-1 (2v)	28	48	56	61	63	60	53	42	90-8-10 (2v)	55	76	83	88	91	87	80	69

Características acústicas

Los valores indicados, se determinan mediante medidas de nivel de presión y potencia sonora en dB(A) obtenidas en campo libre a una distancia equivalente a dos veces la envergadura del ventilador más el diámetro de la hélice, con un mínimo de 1,5 mts.

Espectro de potencia sonora Lw(A) en dB(A) por banda de frecuencia en Hz

Modelo	63	125	250	500	1000	2000	4000	8000	Modelo	63	125	250	500	1000	2000	4000	8000
90-6-2	55	76	83	88	91	87	80	69	100-4-15	74	94	102	107	109	106	99	88
90-12-2 (2v)	40	61	68	73	76	72	65	54	100-8-15 (2v)	59	79	87	92	94	91	84	73
90-6-3	56	77	84	89	92	88	81	70	100-4-20	75	95	103	108	110	107	100	89
90-12-3 (2v)	41	62	69	74	77	73	66	55	100-8-20 (2v)	60	80	88	93	95	92	85	74
90-6-4	57	78	85	90	93	89	82	71	100-6-3	62	82	90	95	97	94	87	76
90-12-4 (2v)	42	63	70	75	78	74	67	56	100-12-3 (2v)	47	67	75	80	82	79	72	61
90-8-1	49	70	77	82	85	81	74	63	100-6-4	63	83	91	96	98	95	88	77
90-8-1,5	50	71	78	83	86	82	75	64	100-12-4 (2v)	48	68	76	81	83	80	73	62
90-8-2	51	72	79	84	87	83	76	65	100-6-5,5	64	84	92	97	99	96	89	78
90-8-3	52	73	80	85	88	84	77	66	100-12-5,5 (2v)	49	69	77	82	84	81	74	63
100-4-7,5	72	92	100	105	107	104	97	86	100-8-1,5	56	76	84	89	91	88	81	70
100-8-7,5 (2v)	57	77	85	90	92	89	82	71	100-8-2	57	77	85	90	92	89	82	71
100-4-10	73	93	101	106	108	105	98	87	100-8-3	57	77	85	90	92	89	82	71
100-8-10 (2v)	58	78	86	91	93	90	83	72	100-8-4	58	78	86	91	93	90	83	72

Dimensiones mm

HCH

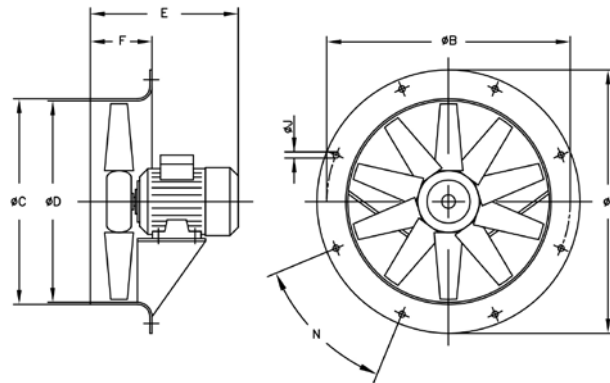

Modelo	ØA	ØB	ØC	ØD	E																F	ØJ	N
					0.16	0.33	0.5	0.75	1	1.5	2	3	4	5.5	7.5	10	15	20					
HCH-35-2	425	395	358	355	-	-	285	-	-	-	-	-	-	-	-	-	-	-	110	10	8x45°		
HCH-35-4	425	395	358	355	257	-	-	-	-	-	-	-	-	-	-	-	-	-	110	10	8x45°		
HCH-40-2	490	450	414	410	-	-	-	-	314	-	-	-	-	-	-	-	-	-	120	12	8x45°		
HCH-40-4	490	450	414	410	-	305	-	-	-	-	-	-	-	-	-	-	-	-	120	12	8x45°		
HCH-45-4	540	500	464	460	-	-	295	-	-	-	-	-	-	-	-	-	-	-	120	12	8x45°		
HCH-45-6	540	500	464	460	-	295	-	-	-	-	-	-	-	-	-	-	-	-	120	12	8x45°		
HCH-56-4	660	620	564	560	-	-	-	316	316	330	354	-	-	-	-	-	-	-	120	12	12x30°		
HCH-56-6	660	620	564	560	-	298	316	316	-	-	-	-	-	-	-	-	-	-	120	12	12x30°		
HCH-63-4	730	690	645	640	-	-	-	-	332	340	366	420	420	-	-	-	-	-	150	12	12x30°		
HCH-63-6	730	690	645	640	-	-	332	332	340	-	-	-	-	-	-	-	-	-	150	12	12x30°		
HCH-71-4	810	770	715	710	-	-	-	-	-	334	360	430	430	-	-	-	-	-	150	12	16x22°30'		
HCH-71-6	810	770	715	710	-	-	-	323	334	360	-	-	-	-	-	-	-	-	150	12	16x22°30'		
HCH-80-4	900	860	805	800	-	-	-	-	-	-	-	425	425	445	-	-	-	-	180	12	16x22°30'		
HCH-80-6	900	860	805	800	-	-	-	-	360	386	425	445	-	-	-	-	-	-	180	12	16x22°30'		
HCH-80-8	900	860	805	800	-	-	380	386	410	-	-	-	-	-	-	-	-	-	180	12	16x22°30'		
HCH-90-4	1015	970	906	900	-	-	-	-	-	-	-	436	430	465	465	-	-	-	180	12	16x22°30'		
HCH-90-6	1015	970	906	900	-	-	-	-	-	-	436	430	465	-	-	-	-	-	180	12	16x22°30'		
HCH-90-8	1015	970	906	900	-	-	-	-	436	436	430	460	-	-	-	-	-	-	180	12	16x22°30'		
HCH-100-4	1115	1070	1006	1000	-	-	-	-	-	-	-	-	-	503	503	612	612	200	15	16x22°30'			
HCH-100-6	1115	1070	1006	1000	-	-	-	-	-	-	440	503	503	-	-	-	-	-	200	15	16x22°30'		
HCH-100-8	1115	1070	1006	1000	-	-	-	-	433	440	503	503	-	-	-	-	-	-	200	15	16x22°30'		

Dimensiones mm

HCT

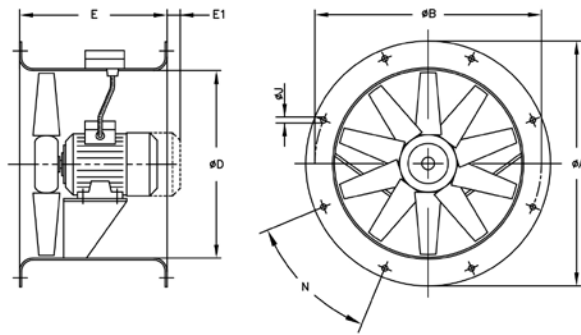

Modelo	ØA	ØB	ØD	E	E1	ØJ	N
HCT-25	310	280	240	230	10	10	4x90°
HCT-31	350	320	280	270	-	10	4x90°
HCT-35	425	395	355	280	-	10	8x45°
HCT-40	490	450	410	320	-	12	8x45°
HCT-45	540	500	460	360	-	12	8x45°
HCT-50	600	560	514	360	-	12	12x30°
HCT-56	660	620	560	400	-	12	12x30°
HCT-63	730	690	640	430	-	12	12x30°
HCT-71	810	770	710	500	-	12	16x22°30'
HCT-80	900	860	800	500	-	12	16x22°30'
HCT-90	1015	970	900	500	-	15	16x22°30'
HCT-100	1115	1070	1000	600	-	15	16x22°30'
HCT-100-4T-15	1115	1070	1000	700	-	15	16x22°30'
HCT-100-4T-20	1115	1070	1000	700	-	15	16x22°30'

Curvas características

Q= Caudal en m³/h, m³/s y cfm.

Pe= Presión estática en mmH₂O, Pa e inwg.

2 Polos=3600 r/min

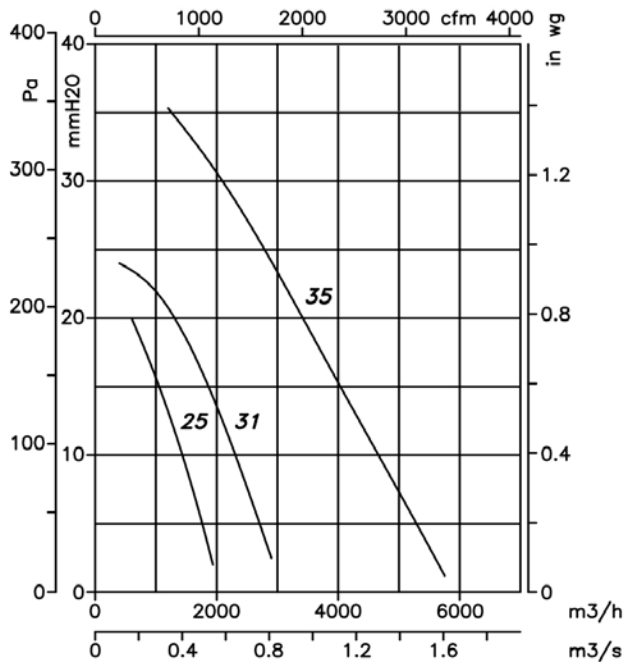

2 Polos=3600 r/min

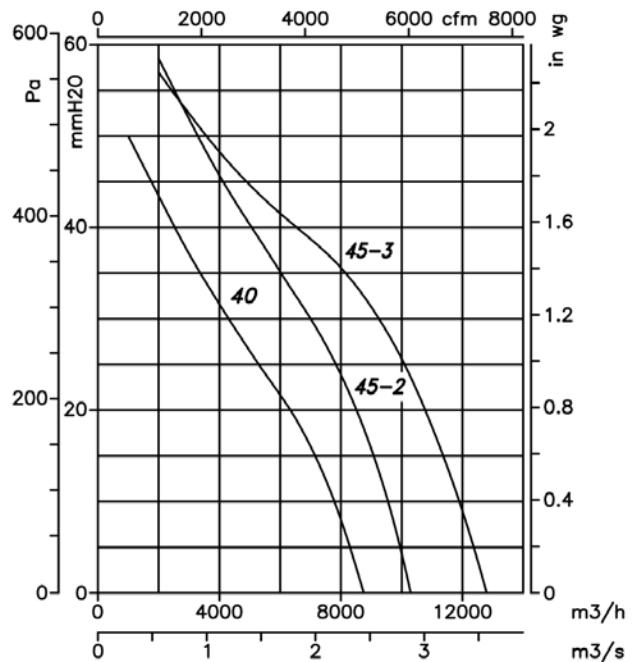

Curvas características

Q= Caudal en m³/h, m³/s y cfm.

Pe= Presión estática en mmH₂O, Pa e inwg.

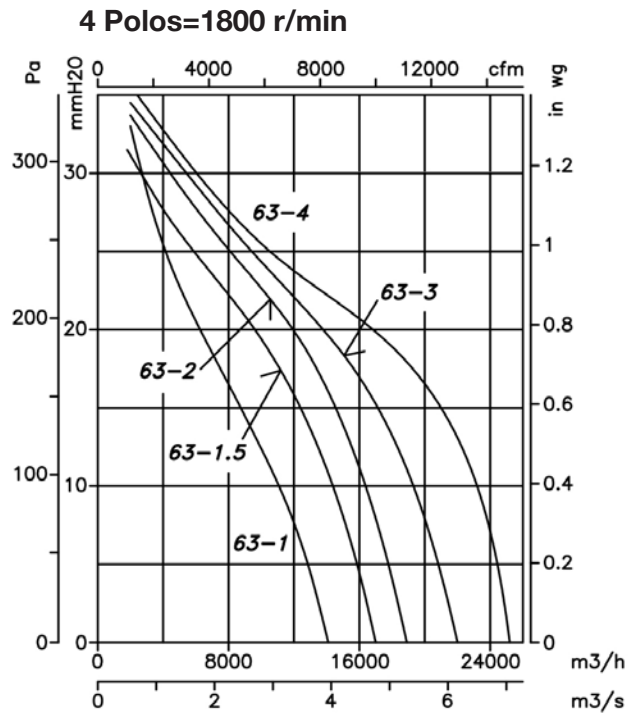
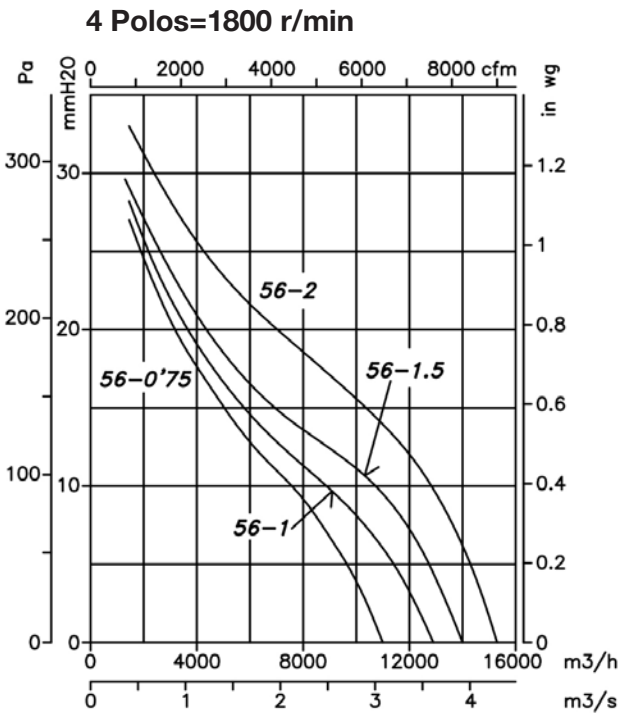
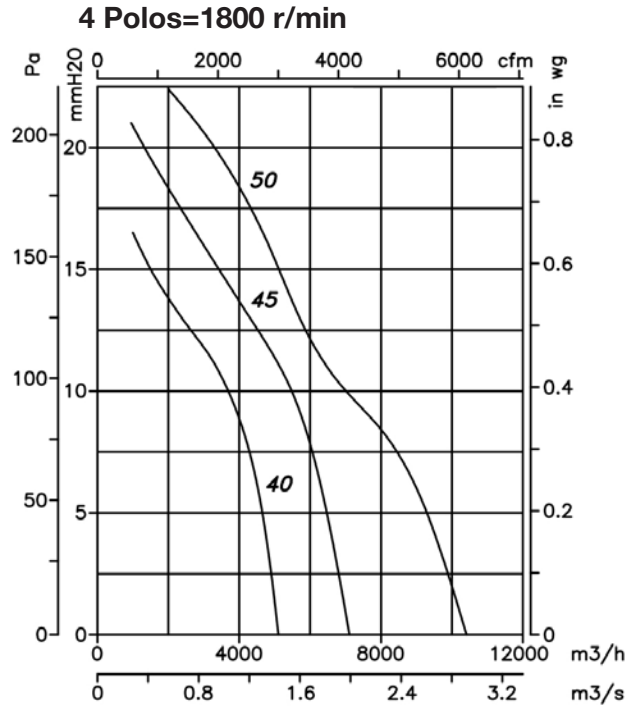
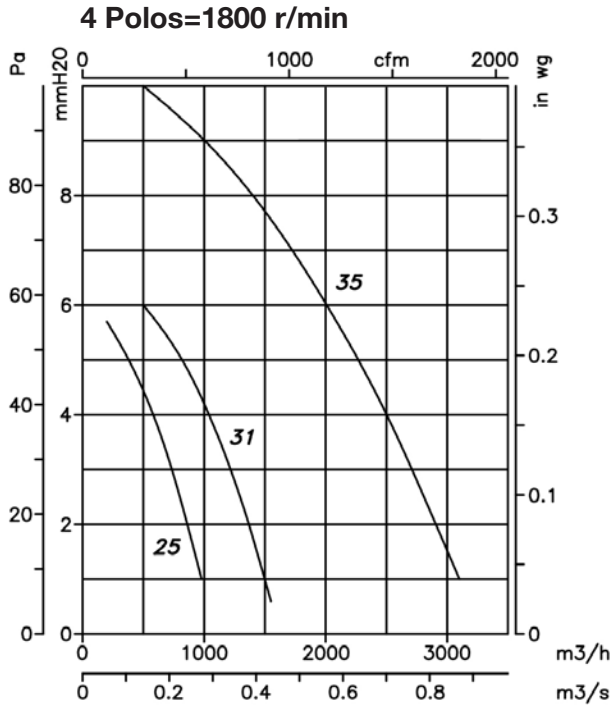

Curvas características

Q= Caudal en m³/h, m³/s y cfm.

Pe= Presión estática en mmH₂O, Pa e in wg.

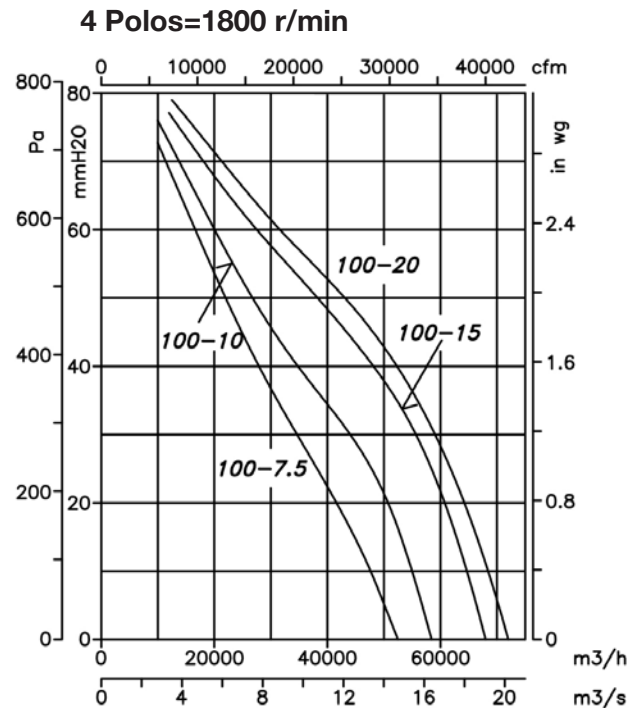
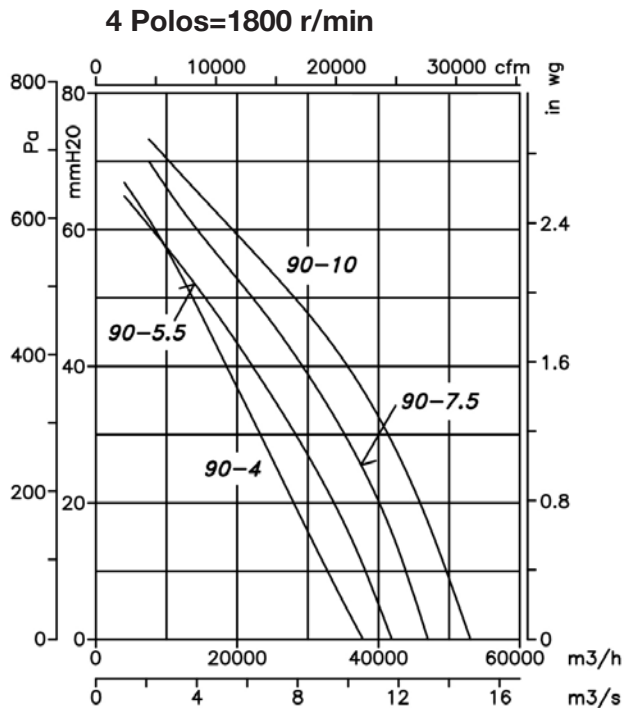
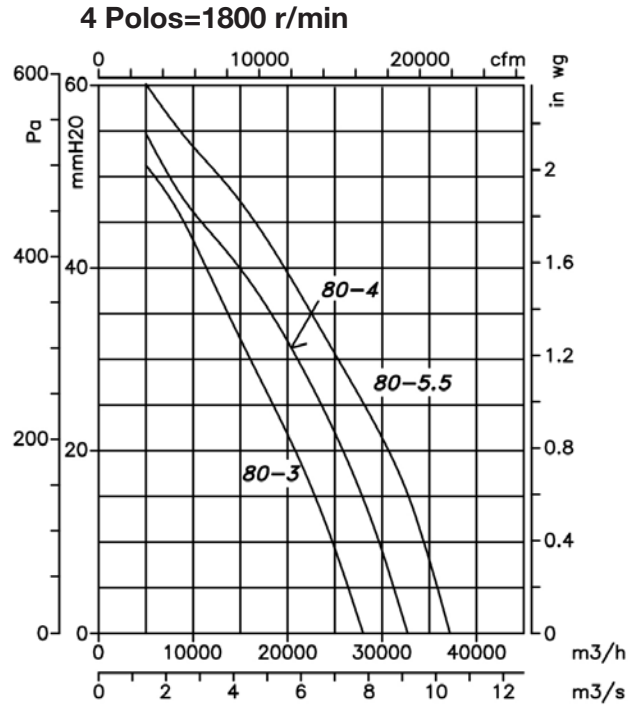
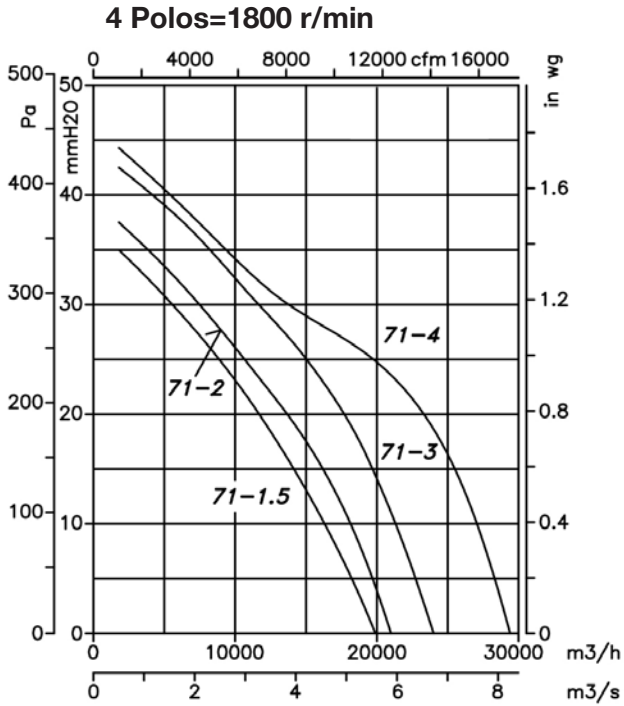

Curvas características

Q= Caudal en m³/h, m³/s y cfm.

Pe= Presión estática en mmH₂O, Pa e inwg.

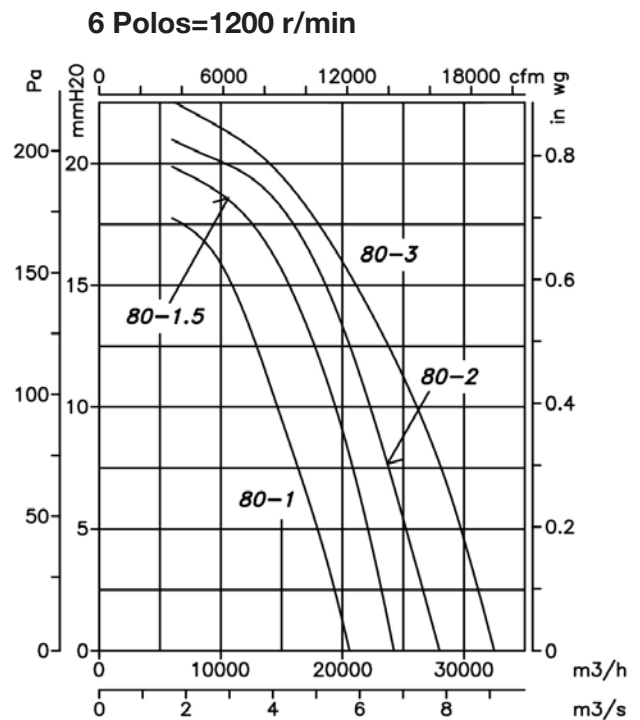
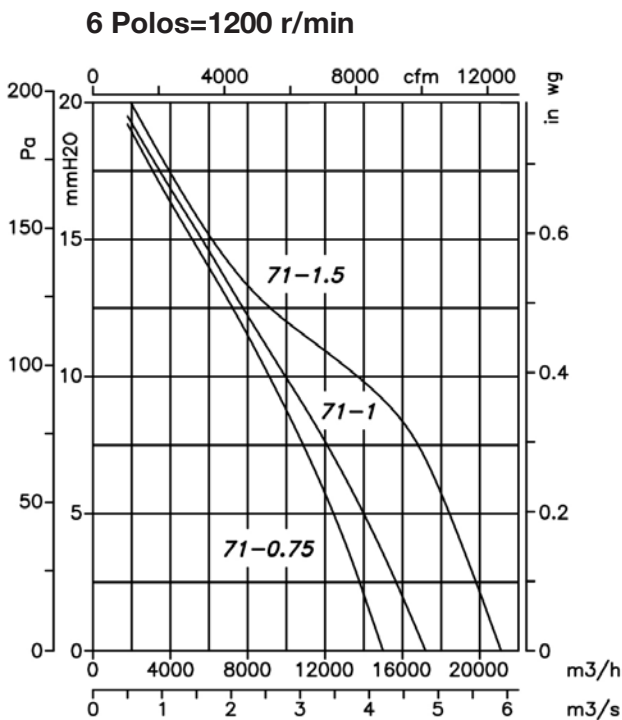
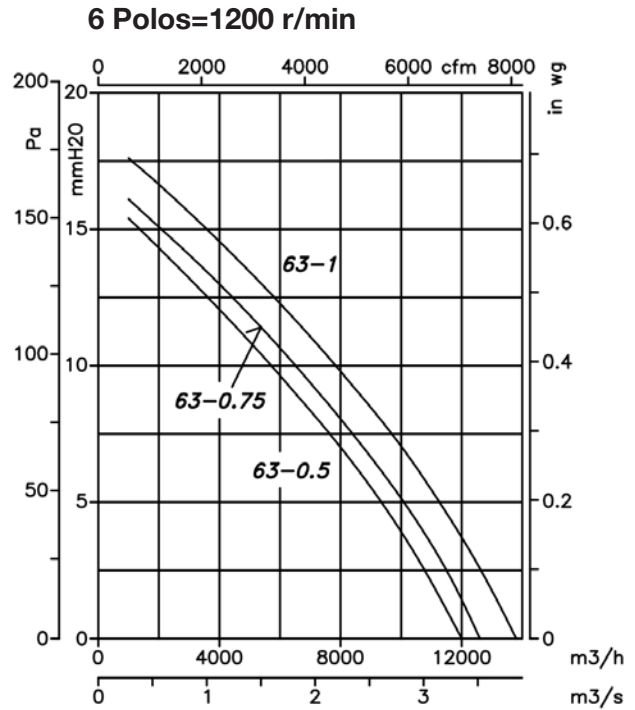
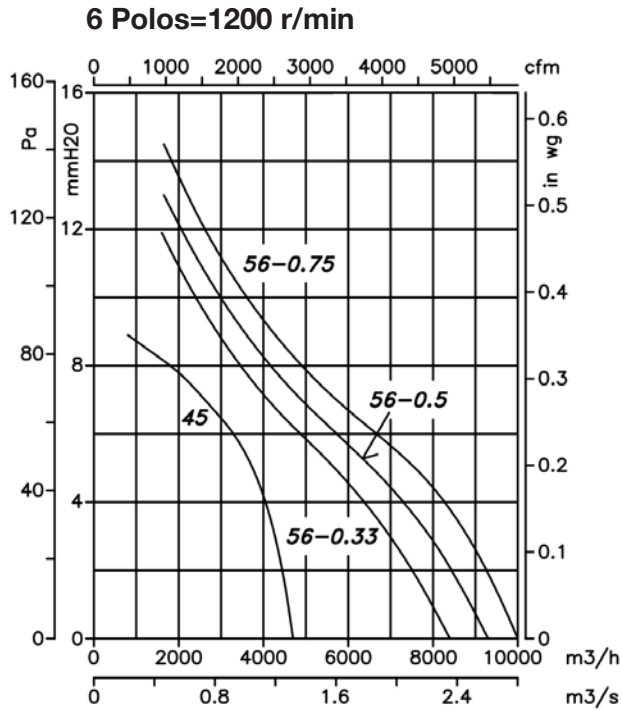

Curvas características

Q= Caudal en m³/h, m³/s y cfm.

Pe= Presión estática en mmH₂O, Pa e in wg.

6 Polos=1200 r/min

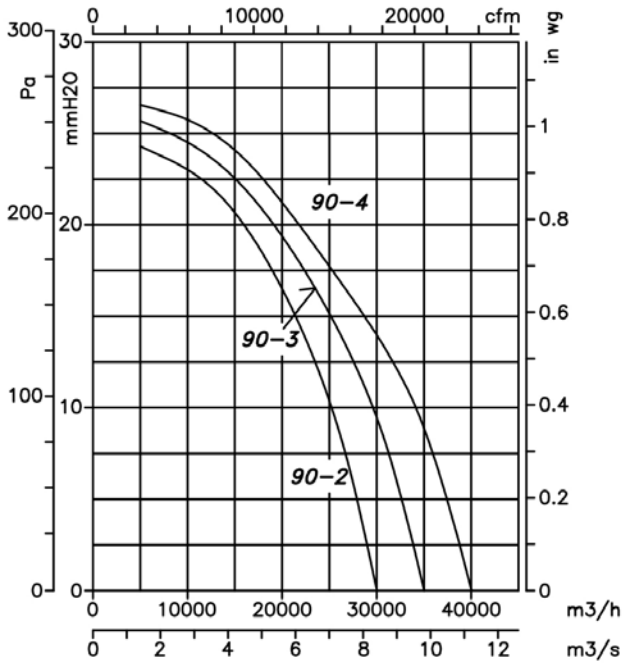

6 Polos=1200 r/min

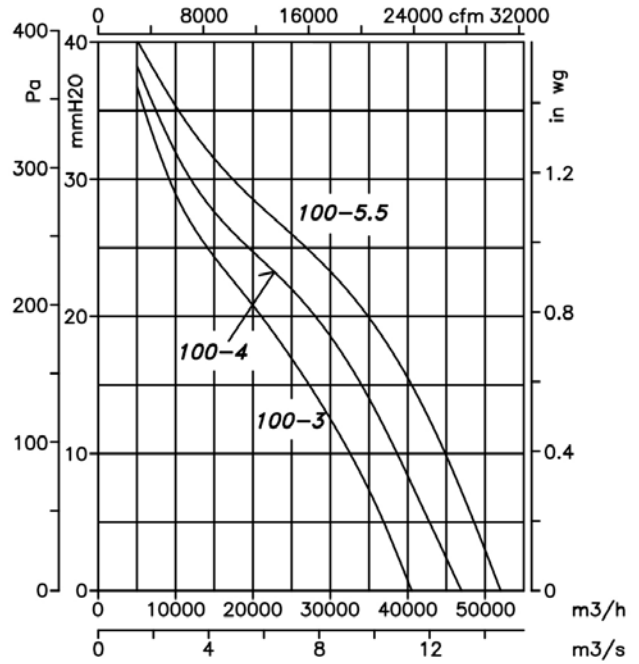

8 Polos=900 r/min

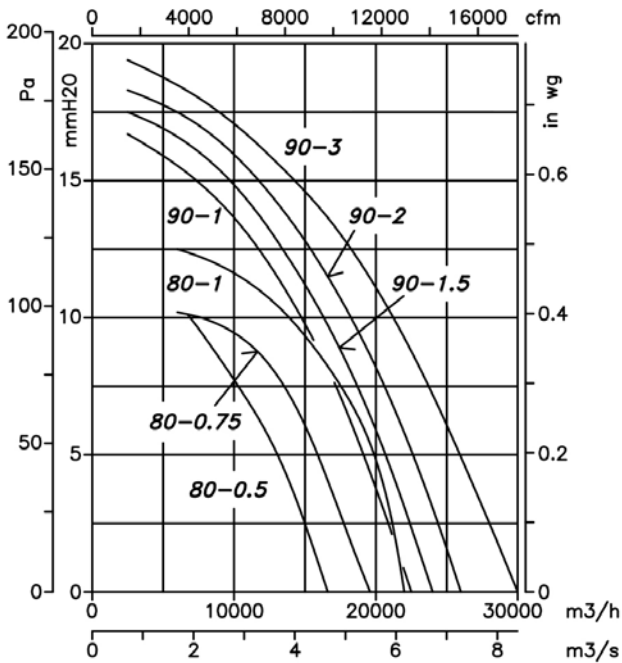

8 Polos=900 r/min

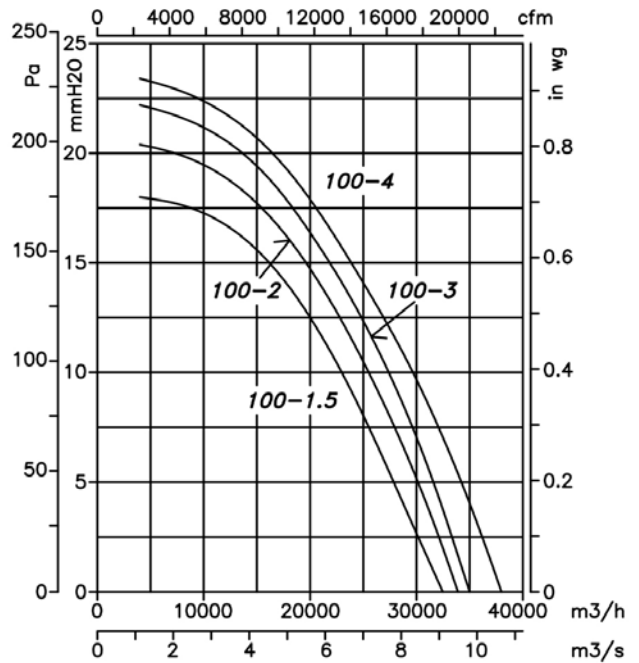

Curvas características

Q= Caudal en m³/h, m³/s y cfm.

Pe= Presión estática en mmH₂O, Pa e inwg.

4 Polos (motor 2 vel. 2/4)

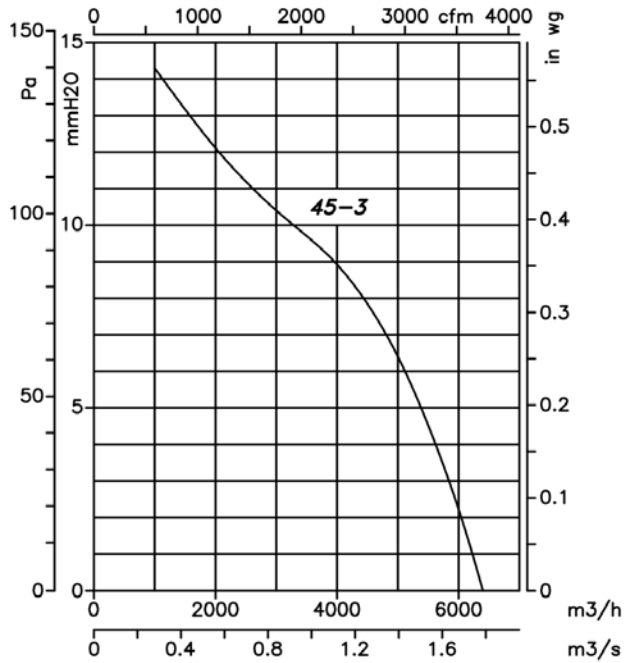

8 Polos (motor 2 vel. 4/8)

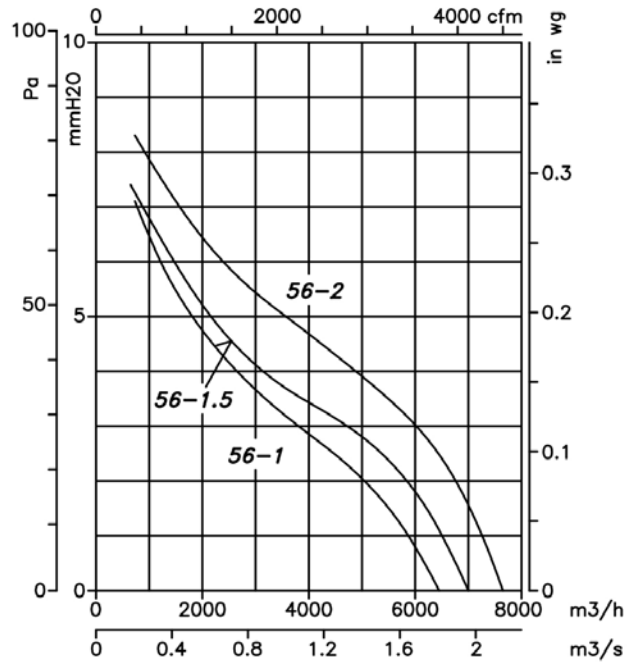

8 Polos (motor 2 vel. 4/8)

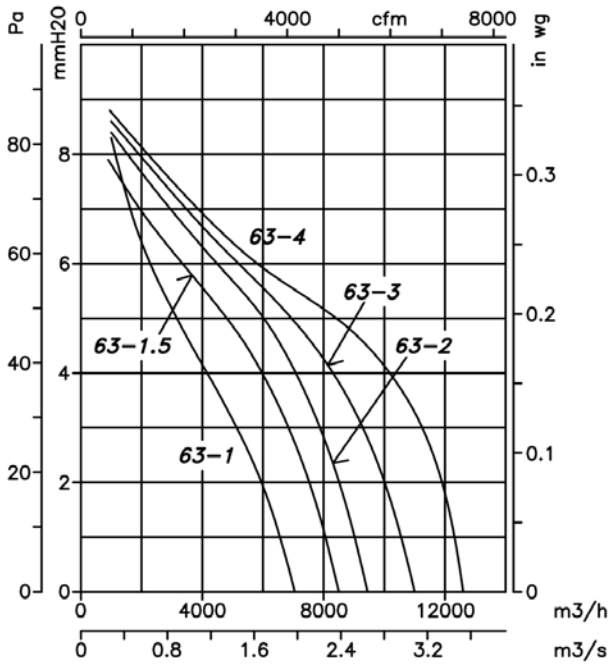

8 Polos (motor 2 vel. 4/8)

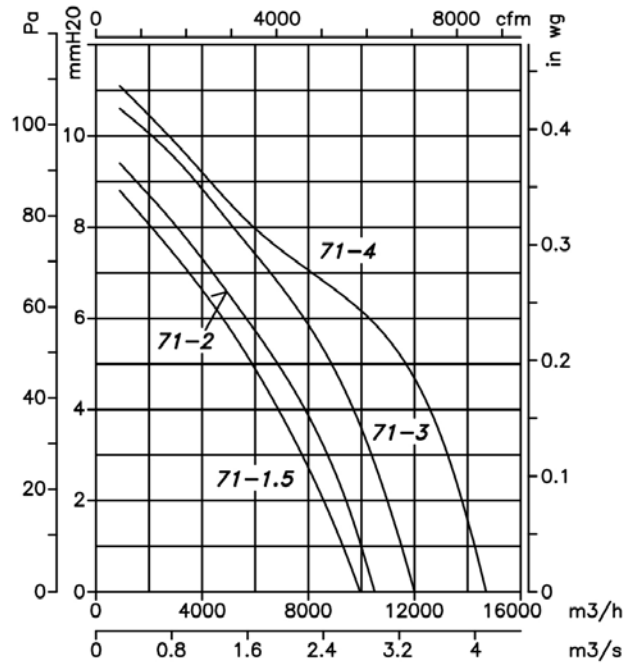

Curvas características

Q= Caudal en m³/h, m³/s y cfm.

Pe= Presión estática en mmH₂O, Pa e inwg.

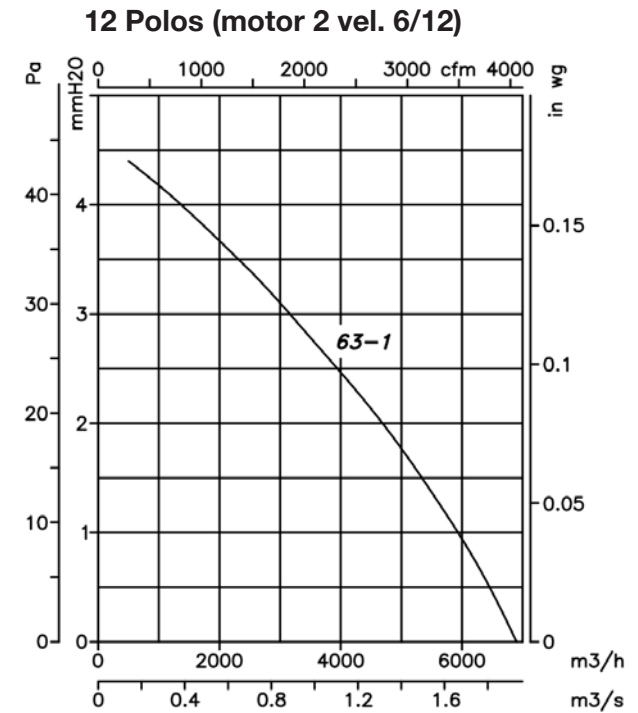
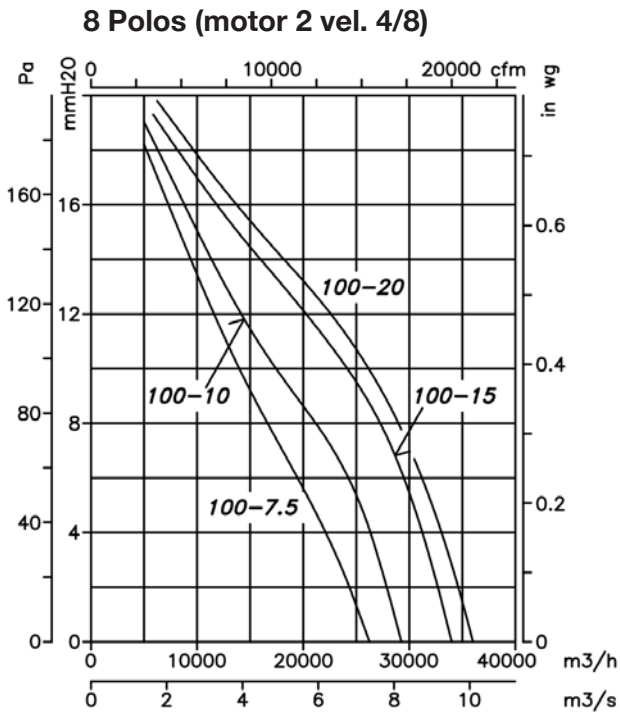
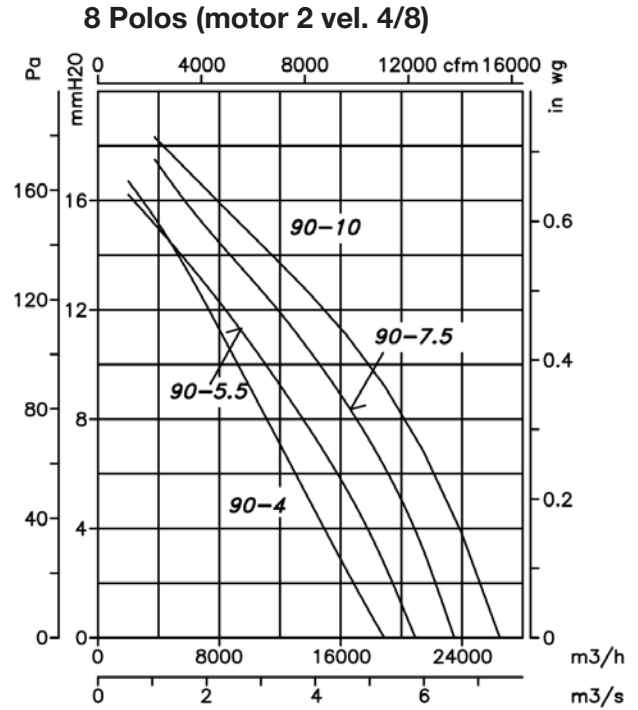
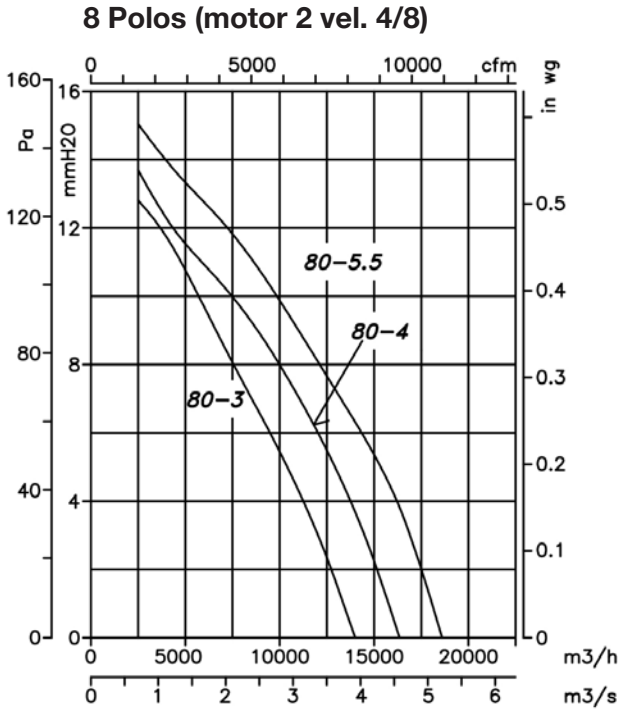

Curvas características

Q= Caudal en m³/h, m³/s y cfm.

Pe= Presión estática en mmH₂O, Pa e inwg.

12 Polos (motor 2 vel. 6/12)

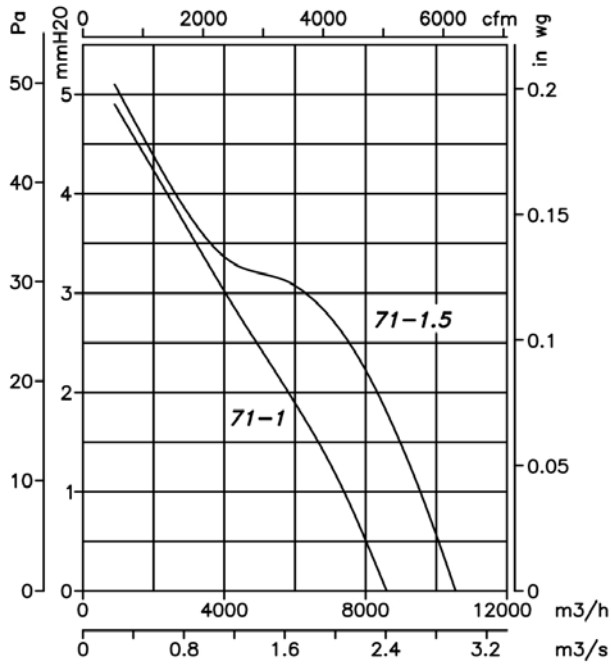

12 Polos (motor 2 vel. 6/12)

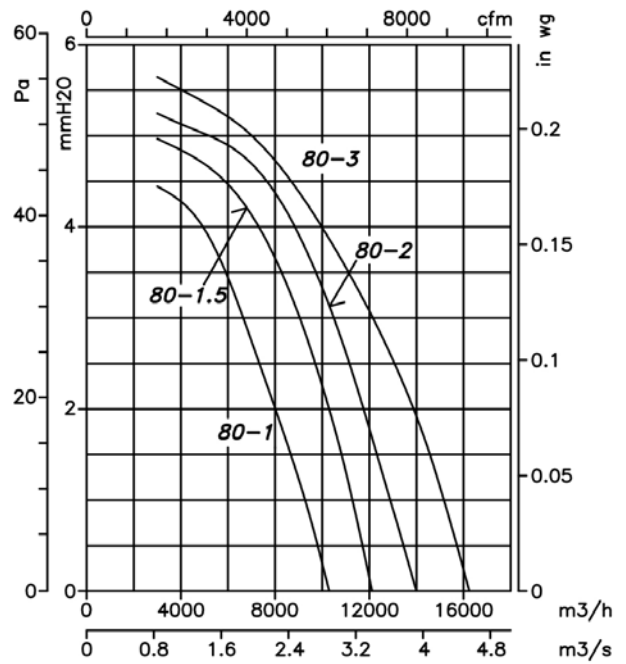

12 Polos (motor 2 vel. 6/12)

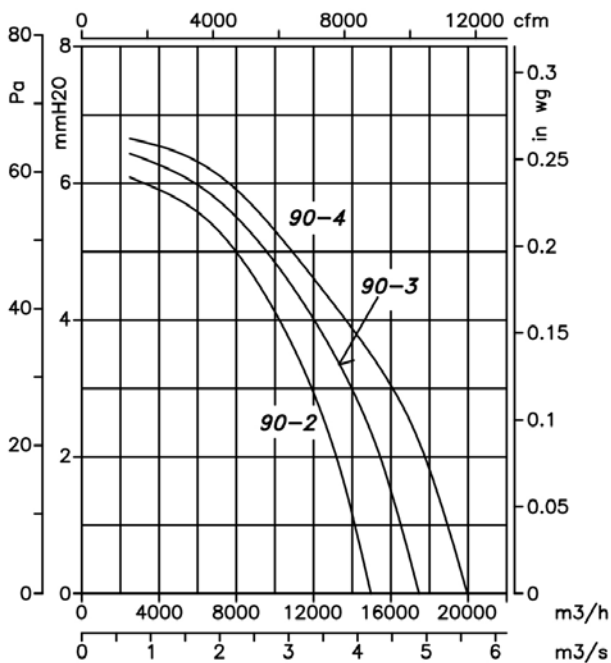

12 Polos (motor 2 vel. 6/12)

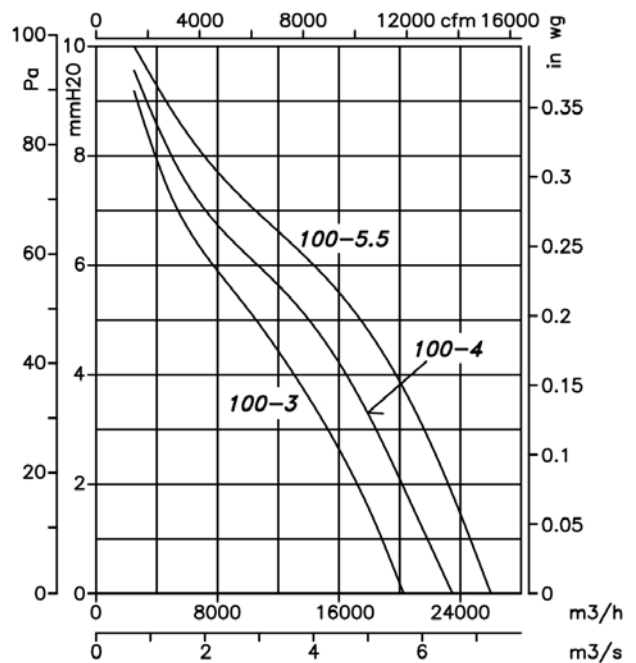

Accesorios

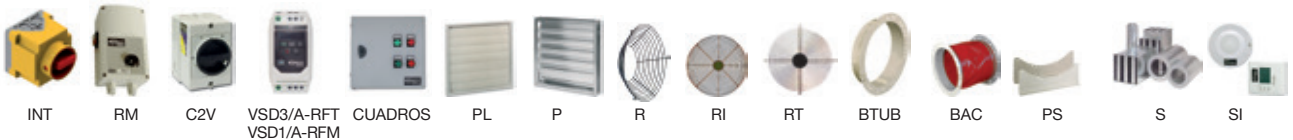

CJHCH



Unidades de ventilación helicoidales, con caja aislada acústicamente

Unidades de ventilación con aislamiento interior acústico, con tapas de registro desmontables.

Ventilador:

- Estructura en acero galvanizado con aislamiento térmico y acústico
- Hélices en poliamida 6 reforzada con fibra de vidrio
- Unidades de ventilación preparadas para trabajo vertical o horizontal
- Dirección aire motor-hélice

Motor:

- Motores de eficiencia IE3 para potencias iguales o superiores a 0.75kW. excepto monofásicos. 2 velocidades y 8 polos.
- Motores clase F, con rodamientos a bolas, protección IP55, excepto modelos monofásicos desde el tamaño 56 hasta el tamaño 56, protección IP54. De 1 ó 2 velocidades según modelo
- Motor Multitensión, diseño especial válido para: 220/380V 60Hz, 254/440V 60Hz, 265/460V 60Hz, 277/480V 60Hz
Temperatura de trabajo : -25°C+ 50°C

Acabado:

- Anticorrosivo en chapa de acero galvanizado.

Bajo demanda:

- Hélices versión AL en fundición de aluminio
- Dirección aire hélice-motor.
- Hélices reversibles 100%
- Bobinados especiales para diferentes tensiones

Código de pedido

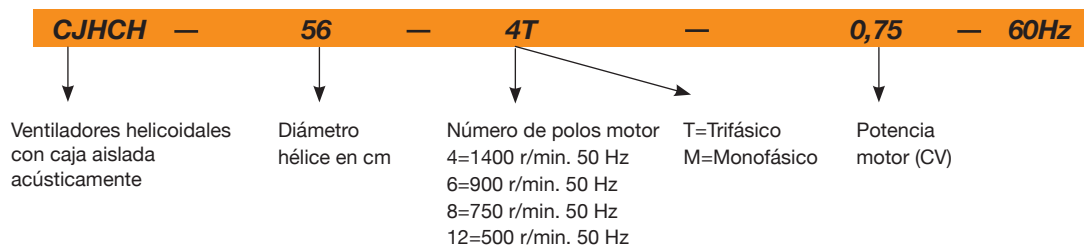

Características técnicas

Modelo	Velocidad (r/min)	Intensidad máx. admisible (A)		Potencia instalada (kW)	Caudal máximo (m³/h)	Nivel presión sonora dB(A)	Peso aprox. (Kg)
		220-277 V	380-480 V				
CJHCH-56-4T-0.75	1656	2,92	1,69	0,55	11050	69	52,1
CJHCH-56-4M-0.75	1740	4,40		0,55	11050	69	52,1
CJHCH-56-4T-1	1704	2,82	1,62	0,75	12950	70	53,1
CJHCH-56-4/8T-1	1716 / 852		2,00 / 0,90	0,75 / 0,20	12950/6475	70/55	54
CJHCH-56-4T-1.5	1746	4,07	2,34	1,10	14000	71	56,8
CJHCH-56-4/8T-1.5	1728 / 852		2,90 / 1,30	1,10 / 0,25	14000/7000	71 / 56	55,3
CJHCH-56-4T-2	1728	5,41	3,11	1,50	15300	72	59,3
CJHCH-56-6T-0.33	1080	1,51	0,87	0,25	8500	59	48,8
CJHCH-56-6M-0.33	1140	1,85		0,25	8400	59	49,8
CJHCH-56-6T-0.5	1080	2,24	1,30	0,37	9300	59	51,1
CJHCH-56-6T-0.75	1080	2,99	1,73	0,55	10000	60	53,1
CJHCH-63-4T-1	1704	2,82	1,62	0,75	14150	70	57,5
CJHCH-63-4/8T-1	1716 / 852		2,00 / 0,90	0,75 / 0,20	14150/7075	70 / 55	58,4
CJHCH-63-4T-1.5	1746	4,07	2,34	1,10	17000	71	61,2
CJHCH-63-4/8T-1.5	1728 / 852		2,90 / 1,30	1,10 / 0,25	17000/8500	71 / 56	59,7
CJHCH-63-4T-2	1728	5,41	3,11	1,50	18900	72	63,7
CJHCH-63-4/8T-2	1704 / 840		3,50 / 1,50	1,50 / 0,37	18900/9450	72 / 57	63,4
CJHCH-63-4T-3	1722	7,93	4,56	2,20	22100	73	72,4
CJHCH-63-4/8T-3	1716 / 852		4,90 / 1,70	2,20 / 0,45	22100/11050	73 / 58	69,4
CJHCH-63-4T-4	1728	10,70	6,15	3,00	25400	74	74,4
CJHCH-63-4/8T-4	1716 / 852		6,50 / 2,30	3,00 / 0,60	25400/12700	74 / 59	72,8
CJHCH-63-6T-0.5	1080	2,24	1,30	0,37	12150	62	55,5
CJHCH-63-6M-0.5	1080	2,69		0,37	12150	62	55,5
CJHCH-63-6T-0.75	1080	2,99	1,73	0,55	12750	63	57,5
CJHCH-63-6T-1	1128	3,36	1,93	0,75	13800	64	64,2
CJHCH-71-4T-1.5	1746	4,07	2,34	1,10	19750	75	77,3
CJHCH-71-4/8T-1.5	1728 / 852		2,90 / 1,30	1,10 / 0,25	19600/9800	75 / 60	75,8
CJHCH-71-4T-2	1728	5,41	3,11	1,50	21100	76	79,8
CJHCH-71-4/8T-2	1704 / 840		3,50 / 1,50	1,50 / 0,37	21100/10550	76 / 61	79,5

Características técnicas

Modelo	Velocidad (r/min)	Intensidad máx. admisible (A)		Potencia instalada (kW)	Caudal máximo (m³/h)	Nivel presión sonora dB(A)	Peso aprox. (Kg)
		220-277 V	380-480 V				
CJHCH-71-4T-3	1722	7,93	4,56	2,20	23950	78	89,3
CJHCH-71-4/8T-3	1716 / 852		4,90 / 1,70	2,20 / 0,45	24150/12075	78 / 63	86,3
CJHCH-71-4T-4	1728	10,70	6,15	3,00	29400	79	91,3
CJHCH-71-4/8T-4	1716 / 852		6,50 / 2,30	3,00 / 0,60	29550/14775	79 / 64	89,7
CJHCH-71-6T-0.75	1080	2,99	1,73	0,55	15150	65	73,2
CJHCH-71-6M-0.75	1080	3,84		0,55	15150	65	73,2
CJHCH-71-6T-1	1128	3,36	1,93	0,75	17250	66	80,3
CJHCH-71-6T-1.5	1134	4,68	2,69	1,10	20950	67	82,3
CJHCH-80-4T-3	1722	7,93	4,56	2,20	28000	79	97,3
CJHCH-80-4/8T-3	1716 / 852		4,90 / 1,70	2,20 / 0,45	28000/14000	79 / 64	94,3
CJHCH-80-4T-4	1728	10,70	6,15	3,00	32700	80	99,3
CJHCH-80-4/8T-4	1716 / 852		6,50 / 2,30	3,00 / 0,60	32700/16350	80 / 65	97,7
CJHCH-80-4T-5.5	1740	13,90	8,00	4,00	37200	81	104,2
CJHCH-80-4/8T-5.5	1716 / 852		8,20 / 2,90	4,00 / 0,80	37200/18600	81 / 66	110,2
CJHCH-80-6T-1	1128	3,36	1,93	0,75	20600	69	88,3
CJHCH-80-6T-1.5	1134	4,68	2,69	1,10	24250	70	90,3
CJHCH-80-6T-2	1140	6,43	3,70	1,50	28000	71	96,3
CJHCH-80-6T-3	1140	9,08	5,22	2,20	32500	72	101,2
CJHCH-90-4T-4	1728	10,70	6,15	3,00	37750	84	123,2
CJHCH-90-4/8T-4	1716 / 852		6,50 / 2,30	3,00 / 0,60	37750/18875	84 / 69	121,6
CJHCH-90-4T-5.5	1740	13,90	8,00	4,00	41850	86	128,1
CJHCH-90-4/8T-5.5	1716 / 852		8,20 / 2,90	4,00 / 0,80	41850/20925	86 / 71	134,1
CJHCH-90-4T-7.5	1758		10,30	5,50	47000	88	143,5
CJHCH-90-4/8T-7.5	1740 / 864		11,80 / 3,80	5,50 / 1,10	47000/23500	88 / 73	153,5
CJHCH-90-4T-10	1758		13,90	7,50	53000	89	154,5
CJHCH-90-4/8T-10	1752 / 870		15,30 / 5,40	7,50 / 1,50	53000/26500	89 / 74	158,5
CJHCH-90-6T-2	1140	6,43	3,70	1,50	30000	75	120,2
CJHCH-90-6T-3	1140	9,08	5,22	2,20	35000	76	125,1
CJHCH-90-6T-4	1164	12,00	6,91	3,00	40000	77	148,5
CJHCH-100-4T-7.5	1758		10,30	5,50	52500	89	152,1
CJHCH-100-4/8T-7.5	1740 / 864		11,80 / 3,80	5,50 / 1,10	52500/26250	89 / 74	162,1
CJHCH-100-4T-10	1758		13,90	7,50	58500	90	163,1
CJHCH-100-4/8T-10	1752 / 870		15,30 / 5,40	7,50 / 1,50	58500/29250	90 / 75	167,1
CJHCH-100-4T-15	1764		20,90	11,00	68000	91	185,7
CJHCH-100-4/8T-15	1764 / 870		23,20 / 8,70	11,00 / 2,80	68000/34000	91 / 76	185,7
CJHCH-100-4T-20	1758		27,90	15,00	71850	92	204,7
CJHCH-100-4/8T-20	1752 / 870		31,72 / 11,75	15,00 / 3,80	72450/36225	92 / 77	200,7
CJHCH-100-6T-3	1140	9,08	5,22	2,20	40500	80	133
CJHCH-100-6T-4	1164	12,00	6,91	3,00	46950	81	157,1
CJHCH-100-6T-5.5	1152	15,60	8,99	4,00	52000	82	165,1

Características acústicas

Los valores indicados, se determinan mediante medidas de nivel de presión y potencia sonora en dB(A) obtenidas en campo libre a una distancia equivalente a dos veces la envergadura del ventilador más el diámetro de la hélice, con un mínimo de 1,5 mts.

Espectro de potencia sonora Lw(A) en dB(A) por banda de frecuencia en Hz

Modelo	63	125	250	500	1000	2000	4000	8000	Modelo	63	125	250	500	1000	2000	4000	8000
56-4-0.75	44	64	72	77	79	76	69	58	71-8-1.5 (2v)	37	57	65	70	72	69	62	51
56-4-1	45	65	73	78	80	77	70	59	71-4-2	53	73	81	86	88	85	78	67
56-8-1 (2v)	30	50	58	63	65	62	55	44	71-8-2 (2v)	38	58	66	71	73	70	63	52
56-4-1.5	46	66	74	79	81	78	71	60	71-4-3	55	75	83	88	90	87	80	69
56-8-1.5 (2v)	31	51	59	64	66	63	56	45	71-8-3 (2v)	40	60	68	73	75	72	65	54
56-4-2	47	67	75	80	82	79	72	61	71-4-4	56	76	84	89	91	88	81	70
56-6-0.33	34	54	62	67	69	66	59	48	71-8-4 (2v)	41	61	69	74	76	73	66	55
56-6-0.5	34	54	62	67	69	66	59	48	71-6-0.75	42	62	70	75	77	74	67	56
56-6-0.75	35	55	63	68	70	67	60	49	71-6-1	43	63	71	76	78	75	68	57
63-4-1	47	67	75	80	82	79	72	61	71-6-1.5	44	64	72	77	79	76	69	58
63-8-1 (2v)	32	52	60	65	67	64	57	46	80-4-3	56	76	84	89	91	88	81	70
63-4-1.5	48	68	76	81	83	80	73	62	80-8-3 (2v)	41	61	69	74	76	73	66	55
63-8-1.5 (2v)	33	53	61	66	68	65	58	47	80-4-4	57	77	85	90	92	89	82	71
63-4-2	49	69	77	82	84	81	74	63	80-8-4 (2v)	42	62	70	75	77	74	67	56
63-8-2 (2v)	34	54	62	67	69	66	59	48	80-4-5.5	58	78	86	91	93	90	83	72
63-4-3	50	70	78	83	85	82	75	64	80-8-5.5 (2v)	43	63	71	76	78	75	68	57
63-8-3 (2v)	35	55	63	68	70	67	60	49	80-6-1	46	66	74	79	81	78	71	60
63-4-4	51	71	79	84	86	83	76	65	80-6-1.5	47	67	75	80	82	79	72	61
63-8-4 (2v)	36	56	64	69	71	68	61	50	80-6-2	48	68	76	81	83	80	73	62
63-6-0.5	39	59	67	72	74	71	64	53	80-6-3	49	69	77	82	84	81	74	63
63-6-0.75	40	60	68	73	75	72	65	54	90-4-4	62	83	90	95	98	94	87	76
63-6-1	41	61	69	74	76	73	66	55	90-8-4 (2v)	47	68	75	80	83	79	72	61
71-4-1.5	52	72	80	85	87	84	77	66	90-4-5.5	64	85	92	97	100	96	89	78

Características acústicas

90-8-5.5 (2v)	49	70	77	82	85	81	74	63
90-4-7.5	66	87	94	99	102	98	91	80
90-8-7.5 (2v)	51	72	79	84	87	83	76	65
90-4-10	67	88	95	100	103	99	92	81
90-8-10 (2v)	52	73	80	85	88	84	77	66
90-6-2	53	74	81	86	89	85	78	67
90-6-3	54	75	82	87	90	86	79	68
90-6-4	55	76	83	88	91	87	80	69
100-4-7.5	69	89	97	102	104	101	94	83
100-8-7.5 (2v)	54	74	82	87	89	86	79	68

100-4-10	70	90	98	103	105	102	95	84
100-8-10 (2v)	55	75	83	88	90	87	80	69
100-4-15	71	91	99	104	106	103	96	85
100-8-15 (2v)	56	76	84	89	91	88	81	70
100-4-20	72	92	100	105	107	104	97	86
100-8-20 (2v)	57	77	85	90	92	89	82	71
100-6-3	60	80	88	93	95	92	85	74
100-6-4	61	81	89	94	96	93	86	75
100-6-5.5	62	82	90	95	97	94	87	76

Dimensiones mm

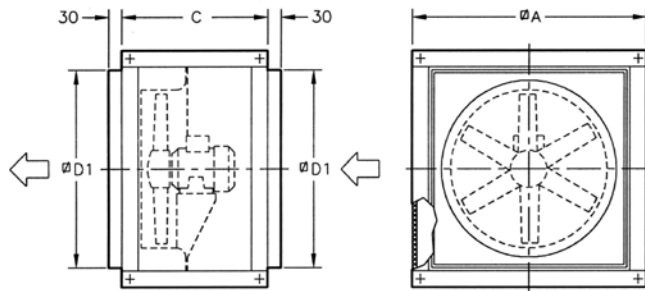

Modelo	ØA	C	ØD1
CJHCH-56/63	825	550	690
CJHCH-71/80	1000	650	850
CJHCH-90/100	1200	750	1050

Curvas características y datos de eficiencia

Ver curvas de la serie HCH-HCT

Accesorios

Ver apartado accesorios.



HCT/IMP-C

Jet fans de gran alcance circulares unidireccionales o reversibles



Deflector para aumento de alcance

Jet fans de gran alcance unidireccionales o reversibles con diseño circular para movimiento de aire y extracción de CO en aparcamientos.

Ventilador:

- Conjunto de ventilador unidireccional o reversible compuesto de ventilador, silenciadores, deflectores y soportes
- Hélices orientables diseñadas para obtener grandes empujes
- Rejilla de protección contra contactos según norma UNE-EN ISO 12499, en los modelos unidireccionales
- Deflector para aumento de alcance del aire, en el lado de impulsión. Los modelos reversibles van equipados con deflectores en ambos lados.
- Silenciadores de alta atenuación con aislamiento térmico y acústico
- Dirección aire motor-hélice o reversible 100%
- Envolvente circular en chapa de acero pintada

Motor:

- Motores clase F, con rodamientos a bolas, protección IP55, de 1 ó 2 velocidades según modelo
- Trifásicos 380-440V. 60Hz.
- Temperatura máxima del aire a transportar: -20°C+ 40°C

con tratamiento nanotecnológico libre de fosfatos.

Bajo demanda:

- Prestaciones de empuje distintas a las indicadas
- Versión homologada para evacuación de humos según norma EN 12101-3 (ver serie THT/IMP)
- Interruptor de seguridad, serie INT incorporado en el ventilador

Acabado:

- Anticorrosivo en resina de poliéster polimerizada a 190 °C, previo desengrase

Código de pedido

HCT/IMP-C	—	UNI	—	38	—	2/4T	—	1,5	—	60Hz
↓		↓		↓		↓		↓		
HCT/IMP: Jet fans de gran alcance circulares unidireccionales o reversibles		Dirección del aire UNI: Unidireccional REV: Reversible		Diámetro hélice en cm.		Número de polos motor 2=3500 r/min. 60 Hz 4=1680 r/min. 60 Hz 6=1080 r/min. 60 Hz 8=900 r/min. 60 Hz 12=750 r/min. 60 Hz		T=Trifásico Potencia motor (c.v)		

60Hz

Características técnicas

Modelo	Velocidad (r/min)	Intensidad máxima (A)		Caudal (m³/h)	Empuje (N)	Velocidad impulsión (m/s)	Potencia instalada (kW)	Presión sonora LpA a 10m dB(A)	Peso aprox. (Kg)
		220-254 V	380-440 V						
Unidireccional									
HCT/IMP-C-UNI-40-4T-0.33	1620	1,66	0,96	5150	19	10,8	0,25	38	88
HCT/IMP-C-UNI-45-4T-0.5	1644	2,02	1,17	7100	28	11,9	0,37	43	120
HCT/IMP-C-UNI-50-4T-0.75	1656	2,92	1,69	10300	47	13,8	0,55	47	186
HCT/IMP-C-UNI-31-2/4T	3432 / 1716		1,50 / 0,55	4260 / 2130	21 / 5	15,6 / 7,8	0,55 / 0,15	51 / 36	65
HCT/IMP-C-UNI-35-2/4T	3450 / 1716		2,10 / 0,80	6360 / 3180	36 / 9	17,8 / 8,9	0,85 / 0,20	52 / 37	70
HCT/IMP-C-UNI-38-2/4T-1,5	3480 / 1740		2,90 / 1,10	8450 / 4225	57 / 15	20,7 / 10,3	1,10 / 0,25	47 / 32	89
HCT/IMP-C-UNI-40-2/4T-1,5	3480 / 1740		2,90 / 1,10	9250 / 4625	60 / 15	20,4 / 10,2	1,10 / 0,25	53 / 38	98
HCT/IMP-C-UNI-45-2/4T-2	3528 / 1752		4,40 / 1,40	10800 / 5400	62 / 15	18,1 / 9,0	1,50 / 0,37	57 / 42	132
HCT/IMP-C-UNI-45-2/4T-3	3516 / 1740		5,70 / 1,80	13200 / 6600	92 / 23	22,1 / 11,0	2,20 / 0,60	58 / 43	133
HCT/IMP-C-UNI-50-2/4T-6	3516 / 1740		10,00 / 3,20	19700 / 9850	165 / 41	26,4 / 13,2	4,50 / 1,30	60 / 45	220
Reversible									
HCT/IMP-C-REV-40-4T-0.33	1620	1,66	0,96	4895	17	10,3	0,25	37	90
HCT/IMP-C-REV-45-4T-0.5	1644	2,02	1,17	6745	25	11,3	0,37	42	120
HCT/IMP-C-REV-50-4T-0.75	1656	2,92	1,69	9785	43	13,1	0,55	46	233
HCT/IMP-C-REV-31-2/4T	3432 / 1716		1,50 / 0,55	3840 / 1920	17 / 4	14,1 / 7,0	0,55 / 0,15	50 / 35	63
HCT/IMP-C-REV-35-2/4T	3450 / 1716		2,10 / 0,80	5940 / 2970	31 / 8	16,7 / 8,3	0,85 / 0,20	51 / 36	70
HCT/IMP-C-REV-38-2/4T-2	3528 / 1752		4,40 / 1,40	8200 / 4100	54 / 14	20,1 / 10,0	1,50 / 0,37	49 / 34	91
HCT/IMP-C-REV-40-2/4T-2	3528 / 1752		4,40 / 1,40	9250 / 4625	60 / 15	20,4 / 10,2	1,50 / 0,37	52 / 37	100
HCT/IMP-C-REV-45-2/4T-2	3528 / 1752		4,40 / 1,40	10300 / 5150	56 / 14	17,2 / 8,6	1,50 / 0,37	56 / 41	131
HCT/IMP-C-REV-45-2/4T-3	3516 / 1740		5,70 / 1,80	12800 / 6400	87 / 22	21,4 / 10,7	2,20 / 0,60	57 / 42	133
HCT/IMP-C-REV-50-2/4T-6	3516 / 1740		10,00 / 3,20	19000 / 9500	153 / 38	25,4 / 12,7	4,50 / 1,30	60 / 45	267

Dimensiones mm

C: Envolverte circular

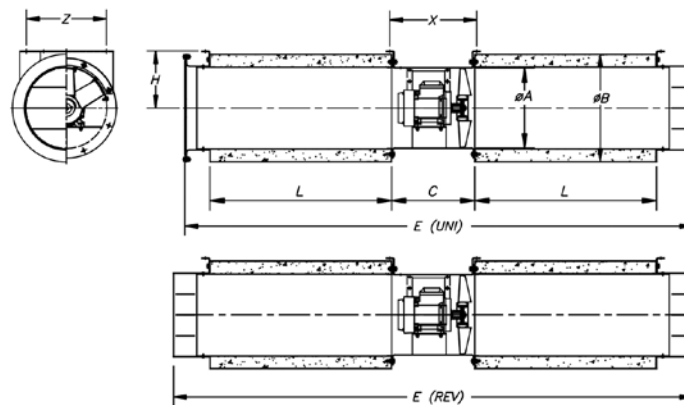

Modelo	ØA	ØB	C	L	Ød	E (UNI)	E (REV)	H	X	Z
HCT/IMP-C-31	315	415	320	700	10	1956	2000	220	345	275
HCT/IMP-C-35	355	460	325	700	12	1960	2005	250	346	300
HCT/IMP-C-38	380	415	340	1000	12	2570	2620	225	530	517
HCT/IMP-C-40	410	510	340	950	12	2485	2540	280	376	340
HCT/IMP-C-45	460	630	360	950	12	2500	2554	355	396	440

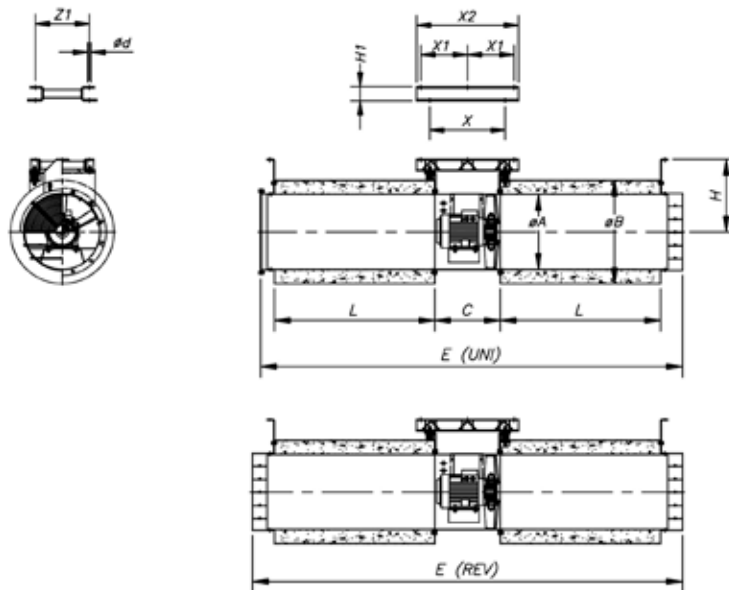

Modelo	ØA	ØB	C	L	Ød	E(UNI)	E(REV)	H	H1-	X	X1	X2	Z	Z1
HCT/IMP-C-50	514	710	450	1100	12	2895	2950	498	80	518	320	700	380	370

Accesorios



INT

C2V

AET

CENTRAL CO

VSD

P-400

HCT/IMP

Jet fans de gran alcance unidireccionales o reversibles

Jet fans de gran alcance unidireccionales o reversibles con diseño octogonal para movimiento de aire y extracción de CO en aparcamientos.

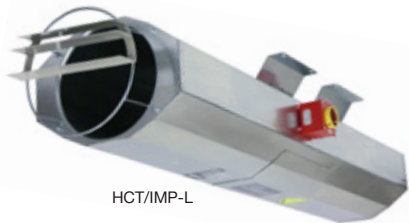

HCT/IMP-L

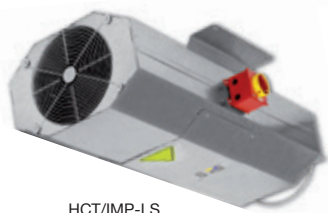

HCT/IMP-LS

Ventilador:

- Conjunto de ventilador unidireccional o reversible compuesto de ventilador, silenciadores, deflectores y soportes
- Hélices orientables diseñadas para obtener grandes empujes
- Rejilla de protección contra contactos según norma UNE-EN ISO 12499, en los modelos unidireccionales
- Deflector para aumento de alcance del aire, en el lado de impulsión. Los modelos reversibles van equipados con deflectores en ambos lados.
- Silenciadores de alta atenuación con aislamiento térmico y acústico
- Interruptor de seguridad, serie INT incorporado en el ventilador (HCT/IMP-L).
- Dirección aire motor-hélice o reversible 100%
- HCT/IMP-L: Envolvente en chapa de acero galvanizada
- HCT/IMP-LS: Envolvente de longitud reducida, en chapa de acero galvanizada

Motor:

- Motores clase F, con rodamientos a bolas, protección IP55, de 1 ó 2 velocidades según modelo
- Trifásicos 380-440V. 60Hz.
- Temperatura máxima del aire a transportar: -20°C+ 40°C

Bajo demanda:

- Prestaciones de empuje distintas a las indicadas
- Versión homologada para evacuación de humos según norma EN 12101-3 (ver serie THT/IMP)

Acabado:

Anticorrosivo en chapa de acero galvanizado.

Código de pedido

HCT/IMP	L	UNI	38	2/4T	1,5	60Hz
HCT/IMP: Jet fans de gran alcance	Diseño L: Envolvente chapa galvanizada LS: Envolvente reducida	Dirección del aire UNI: Unidireccinal REV: Reversible	Diámetro hélice en cm.	Número de polos motor 2=3500 r/min. 60 Hz 4=1680 r/min. 60 Hz	T=Trifásico	Potencia motor (c.v)

60Hz

Características técnicas

Modelo	Velocidad (r/min)	Intensidad máxima (A)	Caudal (m³/h)	Empuje (N)	Velocidad impulsión (m/s)	Potencia instalada (kW)	Presión sonora LpA a 10m dB(A)	Peso aprox. (Kg)
Unidireccional								
HCT/IMP-L-UNI-29-2/4T	3432 / 1716	2,60 / 0,95	-	4000 / 2000	21/ 5	16,8 / 8,4	0,55 / 0,15	37 / 22
HCT/IMP-L-UNI-35-2/4T	3450 / 1716	3,64 / 1,39	-	6360 / 3180	36/ 9	17,8 / 8,9	0,85 / 0,20	52 / 37
HCT/IMP-L-UNI-38-2/4T-1.5	3480 / 1740	5,02 / 1,91	-	8450 / 4225	57/ 15	20,7 / 10,3	1,10 / 0,25	47 / 32
HCT/IMP-L-UNI-40-2/4T-1.5	3480 / 1740	5,02 / 1,91	-	9250 / 4625	60/ 15	20,4 / 10,2	1,10 / 0,25	53 / 38
HCT/IMP-L-UNI-45-2/4T-2	3528 / 1752	7,62 / 2,42	-	10800 / 5400	62/ 15	18,1 / 9,0	1,50 / 0,37	57 / 42
HCT/IMP-L-UNI-45-2/4T-3	3516 / 1740	9,87 / 3,12	-	13200 / 6600	92/ 23	22,1 / 11,0	2,20 / 0,60	58 / 43
HCT/IMP-L-UNI-50-2/4T-6	3516 / 1740	17,32 / 5,54	-	19700 / 9850	165/ 41	26,4 / 13,2	4,50 / 1,30	60 / 45
HCT/IMP-LS-UNI-29-2/4T	3432 / 1716	2,60 / 0,95	-	4000 / 2000	21/ 5	16,8 / 8,4	0,55 / 0,15	39 / 24
HCT/IMP-LS-UNI-35-2/4T	3450 / 1716	3,64 / 1,39	-	6360 / 3180	36/ 9	17,8 / 8,9	0,85 / 0,20	54 / 39
HCT/IMP-LS-UNI-38-2/4T-1.5	3480 / 1740	5,02 / 1,91	-	8450 / 4225	57/ 15	20,7 / 10,3	1,10 / 0,25	49 / 34
HCT/IMP-LS-UNI-40-2/4T-1.5	3480 / 1740	5,02 / 1,91	-	9250 / 4625	60/ 15	20,4 / 10,2	1,10 / 0,25	55 / 40
HCT/IMP-LS-UNI-45-2/4T-2	3528 / 1752	7,62 / 2,42	-	10800 / 5400	62/ 15	18,1 / 9,0	1,50 / 0,37	59 / 44
HCT/IMP-LS-UNI-45-2/4T-3	3516 / 1740	9,87 / 3,12	-	13200 / 6600	92/ 23	22,1 / 11,0	2,20 / 0,60	60 / 45
HCT/IMP-LS-UNI-50-2/4T-6	3516 / 1740	17,32 / 5,54	-	19700 / 9850	165/ 41	26,4 / 13,2	4,50 / 1,30	62 / 47
HCT/IMP-L-UNI-29-2T-0.75	3312	2,57	1,49	4000	21	16,8	0,55	37
HCT/IMP-L-UNI-35-2T-1.5 IE3	3396	4,03	2,32	6360	36	17,8	1,1	52
HCT/IMP-L-UNI-38-2T-1.5 IE3	3396	4,03	2,32	8450	57	20,7	1,1	47
HCT/IMP-L-UNI-40-2T-1.5 IE3	3396	4,03	2,32	9250	60	20,4	1,1	53
HCT/IMP-L-UNI-45-2T-2 IE3	3450	5,34	3,07	10800	62	18,1	1,5	57
HCT/IMP-L-UNI-45-2T-3 IE3	3492	7,32	4,21	13200	92	22,1	2,2	58
HCT/IMP-L-UNI-50-2T-5.5 IE3	3480	13	7,5	19700	165	26,4	4	60

Características técnicas

Modelo	Velocidad (r/min)	Intensidad máxima (A)		Caudal (m³/h)	Empuje (N)	Velocidad impulsión (m/s)	Potencia instalada (kW)	Presión sonora LpA a 10m dB(A)	Peso aprox. (Kg)
		220-277 V	380-440V						
Unidireccional									
HCT/IMP-LS-UNI-29-2T-0.75	3312	2,57	1,49	4000	21	16,8	0,55	39	59
HCT/IMP-LS-UNI-35-2T-1.5 IE3	3396	4,03	2,32	6360	36	17,8	1,1	54	62
HCT/IMP-LS-UNI-38-2T-1.5 IE3	3396	4,03	2,32	8450	57	20,7	1,1	49	80
HCT/IMP-LS-UNI-40-2T-1.5 IE3	3396	4,03	2,32	9250	60	20,4	1,1	55	87
HCT/IMP-LS-UNI-45-2T-2 IE3	3450	5,34	3,07	10800	62	18,1	1,5	59	117
HCT/IMP-LS-UNI-45-2T-3 IE3	3492	7,32	4,21	13200	92	22,1	2,2	60	128
HCT/IMP-LS-UNI-50-2T-5.5 IE3	3480	13	7,5	19700	165	26,4	4	62	195
HCT/IMP-L-UNI-29-4T-0.12	1584	0,65	0,38	1550	3	6,5	0,09	26	63
HCT/IMP-L-UNI-35-4T-0.12	1584	0,65	0,38	3210	10	9,3	0,09	33	59
HCT/IMP-L-UNI-38-4T-0.25	1620	1,23	0,71	4440	16	10,9	0,18	36	86
HCT/IMP-L-UNI-40-4T-0.33	1620	1,66	0,96	5170	20	11,4	0,25	38	96
HCT/IMP-L-UNI-45-4T-0.33	1620	1,66	0,96	5960	21	10,4	0,25	42	129
HCT/IMP-L-UNI-45-4T-0.5	1644	2,02	1,17	7100	29	12,4	0,37	43	118
HCT/IMP-L-UNI-50-4T-0.75	1656	2,92	1,69	10380	51	14,7	0,55	47	203
HCT/IMP-LS-UNI-29-4T-0.12	1584	0,65	0,38	1550	3	6,5	0,09	28	49
HCT/IMP-LS-UNI-35-4T-0.12	1584	0,65	0,38	3210	10	9,3	0,09	35	45
HCT/IMP-LS-UNI-38-4T-0.25	1620	1,23	0,71	4440	16	10,9	0,18	38	68
HCT/IMP-LS-UNI-40-4T-0.33	1620	1,66	0,96	5170	20	11,4	0,25	40	75
HCT/IMP-LS-UNI-45-4T-0.33	1620	1,66	0,96	5960	21	10,4	0,25	44	101
HCT/IMP-LS-UNI-45-4T-0.5	1644	2,02	1,17	7100	29	12,4	0,37	45	90
HCT/IMP-LS-UNI-50-4T-0.75	1656	2,92	1,69	10380	51	14,7	0,55	49	156

Modelo	Velocidad (r/min)	Intensidad máxima (A)		Caudal (m³/h)	Empuje (N)	Velocidad impulsión (m/s)	Potencia instalada (kW)	Presión sonora LpA a 10m dB(A)	Peso aprox. (Kg)
		220-277 V	380-440V						
Reversible									
HCT/IMP-L-REV-29-2/4T	3432 / 1716	2,60 / 0,95	-	3400 / 1700	15 / 4	14,3 / 7,1	0,55 / 0,15	38 / 23	67
HCT/IMP-L-REV-35-2/4T	3450 / 1716	3,64 / 1,39	-	5940 / 2970	31 / 8	16,7 / 8,3	0,85 / 0,20	51 / 36	70
HCT/IMP-L-REV-38-2/4T-2	3528 / 1752	7,62 / 2,42	-	8200 / 4100	54 / 14	20,1 / 10,0	1,50 / 0,37	49 / 34	97
HCT/IMP-L-REV-40-2/4T-2	3528 / 1752	7,62 / 2,42	-	9250 / 4625	60 / 15	20,4 / 10,2	1,50 / 0,37	52 / 37	106
HCT/IMP-L-REV-45-2/4T-2	3528 / 1752	7,62 / 2,42	-	10300 / 5150	56 / 14	17,2 / 8,6	1,50 / 0,37	56 / 41	139
HCT/IMP-L-REV-45-2/4T-3	3516 / 1740	9,87 / 3,12	-	12800 / 6400	87 / 22	21,4 / 10,7	2,20 / 0,60	57 / 42	141
HCT/IMP-L-REV-50-2/4T-6	3516 / 1740	17,32 / 5,54	-	19000 / 9500	153 / 38	25,4 / 12,7	4,50 / 1,30	60 / 45	284
HCT/IMP-LS-REV-29-2/4T	3432 / 1716	2,60 / 0,95	-	3400 / 1700	15 / 4	14,3 / 7,1	0,55 / 0,15	40 / 25	55
HCT/IMP-LS-REV-35-2/4T	3450 / 1716	3,64 / 1,39	-	5940 / 2970	31 / 8	16,7 / 8,3	0,85 / 0,20	53 / 38	56
HCT/IMP-LS-REV-38-2/4T-2	3528 / 1752	7,62 / 2,42	-	8200 / 4100	54 / 14	20,1 / 10,0	1,50 / 0,37	51 / 36	77
HCT/IMP-LS-REV-40-2/4T-2	3528 / 1752	7,62 / 2,42	-	9250 / 4625	60 / 15	20,4 / 10,2	1,50 / 0,37	53 / 39	85
HCT/IMP-LS-REV-45-2/4T-2	3528 / 1752	7,62 / 2,42	-	10300 / 5150	56 / 14	17,2 / 8,6	1,50 / 0,37	58 / 43	111
HCT/IMP-LS-REV-45-2/4T-3	3516 / 1740	9,87 / 3,12	-	12800 / 6400	87 / 22	21,4 / 10,7	2,20 / 0,60	59 / 44	113
HCT/IMP-LS-REV-50-2/4T-6	3516 / 1740	17,32 / 5,54	-	19000 / 9500	153 / 38	25,4 / 12,7	4,50 / 1,30	62 / 47	227
HCT/IMP-L-REV-29-2T-0.75	3312	2,57	1,49	3400	15	14,3	0,55	38	71
HCT/IMP-L-REV-35-2T-1.5 IE3	3396	4,03	2,32	5940	31	16,7	1,1	51	76
HCT/IMP-L-REV-38-2T-2 IE3	3450	5,34	3,07	8200	54	20,1	1,5	49	102
HCT/IMP-L-REV-40-2T-2 IE3	3450	5,34	3,07	9250	60	20,4	1,5	52	111
HCT/IMP-L-REV-45-2T-2 IE3	3450	5,34	3,07	10300	56	17,2	1,5	56	144
HCT/IMP-L-REV-45-2T-3 IE3	3492	7,32	4,21	12800	87	21,4	2,2	57	156
HCT/IMP-L-REV-50-2T-5.5 IE3	3480	13	7,5	19000	153	25,4	4	60	292
HCT/IMP-LS-REV-29-2T-0.75	3312	2,57	1,49	3400	15	14,3	0,55	40	59
HCT/IMP-LS-REV-35-2T-1.5 IE3	3396	4,03	2,32	5940	31	16,7	1,1	53	62
HCT/IMP-LS-REV-38-2T-2 IE3	3450	5,34	3,07	8200	54	20,1	1,5	51	82
HCT/IMP-LS-REV-40-2T-2 IE3	3450	5,34	3,07	9250	60	20,4	1,5	53	90
HCT/IMP-LS-REV-45-2T-2 IE3	3450	5,34	3,07	10300	56	17,2	1,5	58	116
HCT/IMP-LS-REV-45-2T-3 IE3	3492	7,32	4,21	12800	87	21,4	2,2	59	128
HCT/IMP-LS-REV-50-2T-5.5 IE3	3480	13	7,5	19000	153	25,4	4	62	235
HCT/IMP-L-REV-29-4T-0.12	1584	0,65	0,38	1475	3	6,2	0,09	27	61
HCT/IMP-L-REV-35-4T-0.12	1584	0,65	0,38	3050	9	8,8	0,09	34	59
HCT/IMP-L-REV-38-4T-0.33	1620	1,66	0,96	4220	15	10,3	0,25	37	86
HCT/IMP-L-REV-40-4T-0.33	1620	1,66	0,96	4910	18	10,9	0,25	39	95
HCT/IMP-L-REV-45-4T-0.33	1620	1,66	0,96	5660	19	9,9	0,25	43	128
HCT/IMP-L-REV-45-4T-0.5	1644	2,02	1,17	6745	26	11,8	0,37	44	118
HCT/IMP-L-REV-50-4T-0.75	1656	2,92	1,69	9860	46	13,9	0,55	48	253
HCT/IMP-LS-REV-29-4T-0.12	1584	0,65	0,38	1475	3	6,2	0,09	29	49
HCT/IMP-LS-REV-35-4T-0.12	1584	0,65	0,38	3050	9	8,8	0,09	36	45
HCT/IMP-LS-REV-38-4T-0.33	1620	1,66	0,96	4220	15	10,3	0,25	39	66
HCT/IMP-LS-REV-40-4T-0.33	1620	1,66	0,96	4910	18	10,9	0,25	41	74
HCT/IMP-LS-REV-45-4T-0.33	1620	1,66	0,96	5660	19	9,9	0,25	45	100
HCT/IMP-LS-REV-45-4T-0.5	1644	2,02	1,17	6745	26	11,8	0,37	46	90
HCT/IMP-LS-REV-50-4T-0.75	1656	2,92	1,69	9860	46	13,9	0,55	50	196

Dimensiones mm

L: Envoltente chapa galvanizada
LS: Envoltente reducida

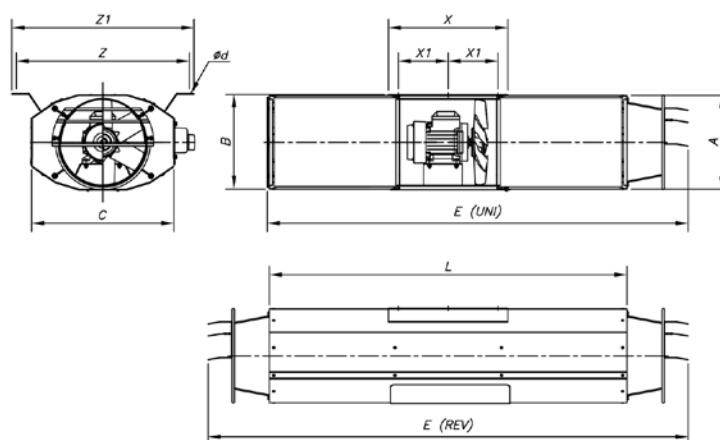

Modelo	A	B	C	ød	E (UNI)	E (REV)	L	X	X1	Z	Z1
HCT/IMP-LS-29	319,5	324	479	12x26	1410	1610	1200	400	167	580	610
HCT/IMP-L-29	319,5	324	479	12x26	2210	2410	2000	400	167	580	610
HCT/IMP-LS-35	383	386	523	12x26	1410	1610	1200	400	167	614	644
HCT/IMP-L-35	383	386	523	12x26	2210	2410	2000	400	167	614	644
HCT/IMP-LS-38	406	409	550	12x26	1410	1610	1200	400	170	640	670
HCT/IMP-L-38	406	409	550	12x26	2210	2410	2000	400	170	640	670
HCT/IMP-LS-40	436	439	582	12x26	1410	1610	1200	400	170	670	700
HCT/IMP-L-40	436	439	582	12x26	2210	2410	2000	400	170	670	700
HCT/IMP-LS-45	486	489	630	12x26	1410	1610	1200	400	170	724	754
HCT/IMP-L-45	486	489	630	12x26	2210	2410	2000	400	170	724	754
HCT/IMP-LS-50	546	549	742	12x26	1445	1675	1200	580	255	778	808
HCT/IMP-L-50	546	549	742	12x26	2245	2475	2000	580	255	778	808

Aplicación en garajes

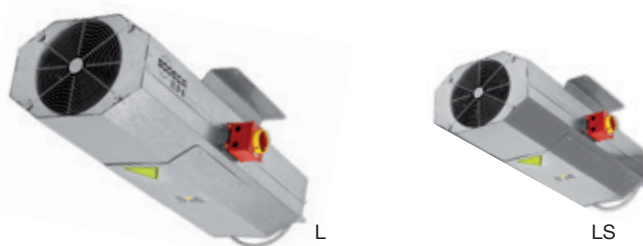

Accesorios



INT

C2V

AET

CENTRAL CO

VSD

P-400

HFW



Ventiladores tubulares galvanizados en caliente

Ventiladores helicoidales tubulares diseñados con cuatro brazos soporte para reducir vibraciones, y equipados con hélice de aluminio aerodinámica de bajo consumo.

Ventilador:

- Dirección aire motor-hélice.
- Hélices versión AL en fundición de aluminio.
- Aro soporte en chapa de acero con doble brida y pasacables para alimentación del motor.
- Envolvente tubular en chapa de acero galvanizado en caliente.

220/380V 60Hz, 254/440V 60Hz, 265/460V 60Hz, 277/480V 60Hz

- Temperatura de trabajo: -25°C +50°C.

Acabado:

- Galvanizado en caliente

Bajo demanda:

Motor:

- Motores de eficiencia IE3 para potencias iguales o superiores a 0,75kW, excepto monofásicos, 2 velocidades y 8 polos.
- Motores clase F, con rodamientos a bolas, protección IP55.
- Motor Multitensión, diseño especial válido para:

- Dirección aire hélice-motor.
- Hélices versión PL en poliamida con fibra de vidrio.
- Hélices reversibles 100%.
- Bobinados especiales para diferentes tensiones.
- Certificación ATEX Categoría 2.

Código de pedido

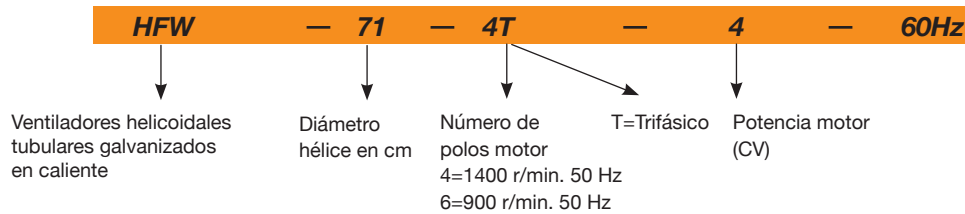

Características técnicas

60Hz

Modelo	Velocidad (r/min)	Intensidad máx admisible (A)		Potencia instalada (kW)	Ángulo inclinación palas (°)	Caudal máximo (m³/h)	Nivel presión sonora dB(A)	Peso aprox. (Kg)
		220-277V	380-480V					
HFW-56-4T-1	1692	3,10	1,79	0,75	22	11250	76,65	28
HFW-56-4T-1,5	1680	4,03	2,32	1,10	30	13600	77,70	32
HFW-56-4T-2	1716	5,96	3,44	1,50	36	15050	78,75	30
HFW-56-6T-0,75	1092	2,59	1,49	0,55	38	10150	65,10	23
HFW-63-4T-1	1692	3,10	1,79	0,75	14	15200	76,65	29
HFW-63-4T-1,5	1680	4,03	2,32	1,10	20	17800	77,70	32
HFW-63-4T-2	1716	5,96	3,44	1,50	24	19300	78,75	35
HFW-63-4T-3	1734	8,36	4,83	2,20	32	22150	79,80	43
HFW-63-4T-4	1734	10,96	6,33	3,00	38	24250	80,85	45
HFW-63-6T-0,75	1092	2,59	1,49	0,55	28	13600	68,25	29
HFW-63-6T-1	1134	3,90	2,20	0,75	38	15900	69,30	35
HFW-71-4T-1,5	1680	4,03	2,32	1,10	12	19500	81,90	35
HFW-71-4T-2	1716	5,96	3,44	1,50	14	20900	82,95	38
HFW-71-4T-3	1734	8,36	4,83	2,20	22	25100	85,05	47
HFW-71-4T-4	1734	10,96	6,33	3,00	28	27500	86,10	49
HFW-71-6T-0,75	1092	2,59	1,49	0,55	20	16100	70,35	31
HFW-71-6T-1	1134	3,90	2,20	0,75	26	17300	71,40	38
HFW-71-6T-1,5	1134	4,88	2,82	1,10	34	19950	72,45	40
HFW-80-4T-3	1734	8,36	4,83	2,20	12	25450	86,10	55
HFW-80-4T-4	1734	10,96	6,33	3,00	16	30250	87,15	57
HFW-80-4T-5,5	1728	14,10	8,12	4,00	18	32750	88,20	62
HFW-80-6T-1,5	1134	4,88	2,82	1,10	18	21450	75,60	48
HFW-80-6T-2	1146	6,42	3,71	1,50	26	25950	76,65	54
HFW-80-6T-3	1146	9,30	5,30	2,20	32	29950	77,70	59
HFW-90-4T-4	1734	10,96	6,33	3,00	8	33600	91,35	66
HFW-90-4T-5,5	1728	14,10	8,12	4,00	12	38900	93,45	71
HFW-90-4T-7,5	1728		10,60	5,50	18	46150	95,55	87
HFW-90-4T-10 IE3	1758		8,06	7,50	22	50150	96,60	98
HFW-90-6T-2	1146	6,42	3,71	1,50	16	28800	80,85	63
HFW-90-6T-3	1146	9,30	5,30	2,20	24	34000	81,90	68
HFW-90-6T-4	1152	12,70	7,30	3,00	30	38900	82,95	92
HFW-100-4T-7,5	1728		10,60	5,50	10	46850	96,60	95
HFW-100-4T-10 IE3	1758		8,06	7,50	16	57400	97,65	106
HFW-100-4T-15 IE3	1764		20,90	11,00	22	66300	98,70	129
HFW-100-4T-20 IE3	1764		28,30	15,00	28	76150	99,75	148
HFW-100-6T-3	1146	9,30	5,30	2,20	16	37600	86,10	76
HFW-100-6T-4	1152	12,70	7,30	3,00	20	41150	87,15	100
HFW-100-6T-5,5	1152	16,50	9,46	4,00	26	47800	88,20	108

Características acústicas

Los valores indicados, se determinan mediante medidas de nivel de presión y potencia sonora en dB(A) obtenidas en campo libre a una distancia equivalente a dos veces la envergadura del ventilador más el diámetro de la hélice, con un mínimo de 1,5 mts.

Espectro de potencia sonora Lw(A) en dB(A) por banda de frecuencia en Hz

Modelo	63	125	250	500	1000	2000	4000	8000	Modelo	63	125	250	500	1000	2000	4000	8000
HFW-56-4T-1	48	68	76	81	83	80	73	62	HFW-80-4T-4	56	76	84	89	91	88	81	74
HFW-56-4T-1,5	49	69	77	82	84	81	74	63	HFW-80-4T-5,5	56	76	84	89	91	88	81	70
HFW-56-4T-2	50	70	78	83	85	82	75	64	HFW-80-6T-1,5	49	66	74	79	81	78	71	60
HFW-56-6T-0,75	37	57	65	70	72	69	62	51	HFW-80-6T-2	50	67	75	80	82	79	72	61
HFW-63-4T-1	50	70	78	83	85	82	75	64	HFW-80-6T-3	51	68	76	81	83	80	73	62
HFW-63-4T-1,5	48	68	76	81	83	80	73	65	HFW-90-4T-4	61	82	89	94	97	93	86	79
HFW-63-4T-2	52	68	76	81	83	80	73	66	HFW-90-4T-5,5	60	81	88	93	96	92	85	74
HFW-63-4T-3	53	70	78	83	85	82	77	67	HFW-90-4T-7,5	59	80	87	92	95	91	84	73
HFW-63-4T-4	54	71	79	84	86	83	78	68	HFW-90-4T-10	58	79	86	91	94	90	83	72
HFW-63-6T-0,75	42	60	68	73	75	72	65	56	HFW-90-6T-2	58	79	86	91	94	90	83	72
HFW-63-6T-1	43	62	70	75	77	74	67	57	HFW-90-6T-3	56	70	77	82	85	81	74	63
HFW-71-4T-1,5	54	74	82	87	89	86	79	69	HFW-90-6T-4	57	72	79	84	87	83	76	65
HFW-71-4T-2	53	73	81	86	88	85	78	70	HFW-100-4T-7,5	64	84	92	97	99	96	89	78
HFW-71-4T-3	58	72	80	85	87	84	77	71	HFW-100-4T-10	62	82	90	95	97	94	87	76
HFW-71-4T-4	59	73	81	86	88	85	78	72	HFW-100-4T-15	61	81	89	94	96	93	86	75
HFW-71-6T-0,75	44	63	72	74	76	73	66	55	HFW-100-4T-20	63	83	91	96	98	95	88	77
HFW-71-6T-1	45	65	73	75	77	74	67	56	HFW-100-6T-3	61	72	80	85	87	84	77	66
HFW-71-6T-1,5	46	66	71	76	78	75	68	57	HFW-100-6T-4	64	72	80	85	87	84	77	66
HFW-80-4T-3	57	77	85	90	92	89	82	73	HFW-100-6T-5,5	64	73	81	86	88	85	78	67

Dimensiones mm

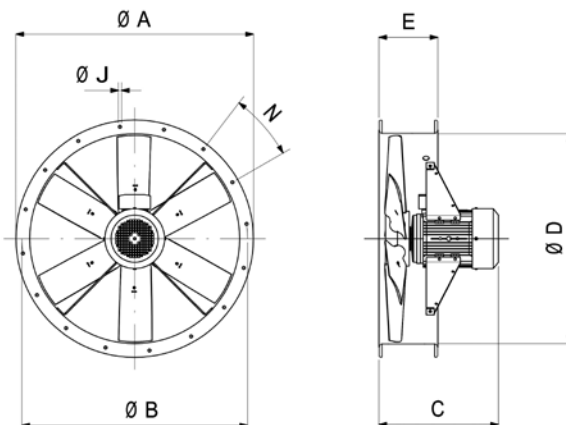

	ØA	ØB	0,75	1	1,5	2	3	C	4	5,5	7,5	10	15	20	ØD	E	ØJ	N
HFW-56-4	665	620	-	330	380	380	-	4	-	-	-	-	-	-	560	225	12	12x30°
HFW-56-6	665	620	330	-	-	-	-	-	-	-	-	-	-	-	560	225	12	12x30°
HFW-63-4	735	690	-	379	429	429	470	470	-	-	-	-	-	-	640	225	12	12x30°
HFW-63-6	735	690	379	429	-	-	-	-	-	-	-	-	-	-	640	225	12	12x30°
HFW-71-4	815	770	-	-	389	389	430	430	-	-	-	-	-	-	710	225	12	16x22°30'
HFW-71-6	815	770	339	389	389	-	-	-	-	-	-	-	-	-	710	225	12	16x22°30'
HFW-80-4	905	860	-	-	-	-	436	436	460	-	-	-	-	-	800	225	12	16x22°30'
HFW-80-6	905	860	-	-	395	436	460	-	-	-	-	-	-	-	800	225	12	16x22°30'
HFW-90-4	1018	970	-	-	-	-	-	401	425	485	525	-	-	-	900	225	15	16x22°30'
HFW-90-6	1018	970	-	-	-	401	425	485	-	-	-	-	-	-	900	225	15	16x22°30'
HFW-100-4	1118	1070	-	-	-	-	-	-	-	488	528	643	703	1000	225	15	16x22°30'	
HFW-100-6	1118	1070	-	-	-	-	428	488	528	-	-	-	-	-	1000	225	15	16x22°30'

Accesorios

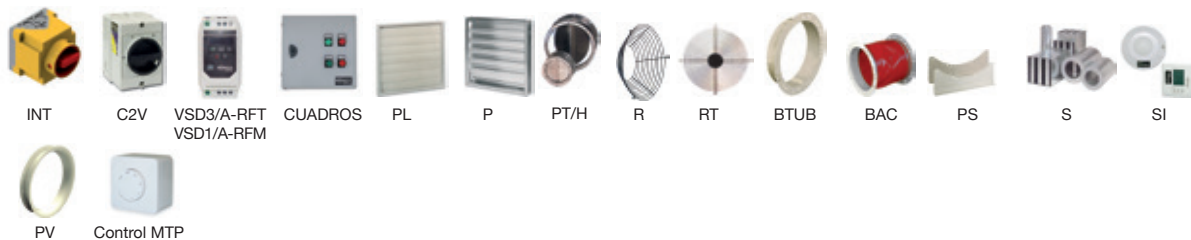

Curvas características

Q= Caudal en m³/h, m³/s y cfm.

Pe= Presión estática en mmH₂O, Pa e inwg.

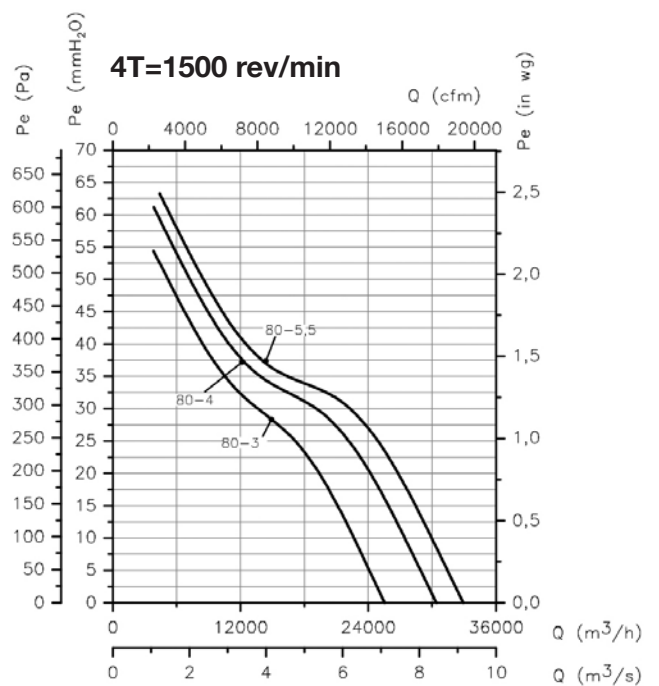
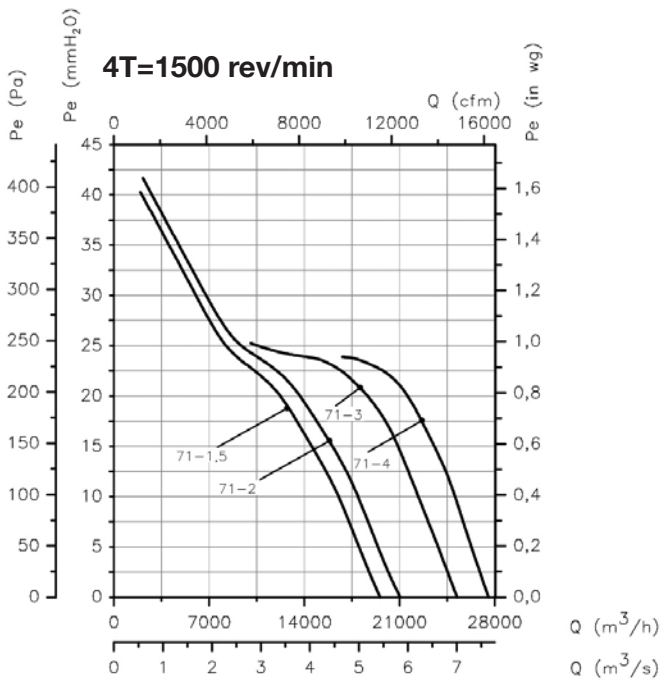
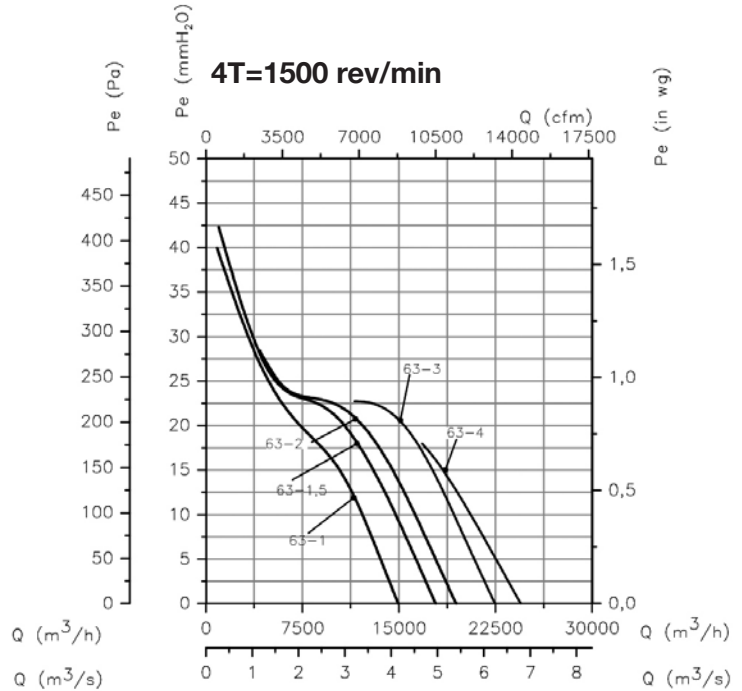
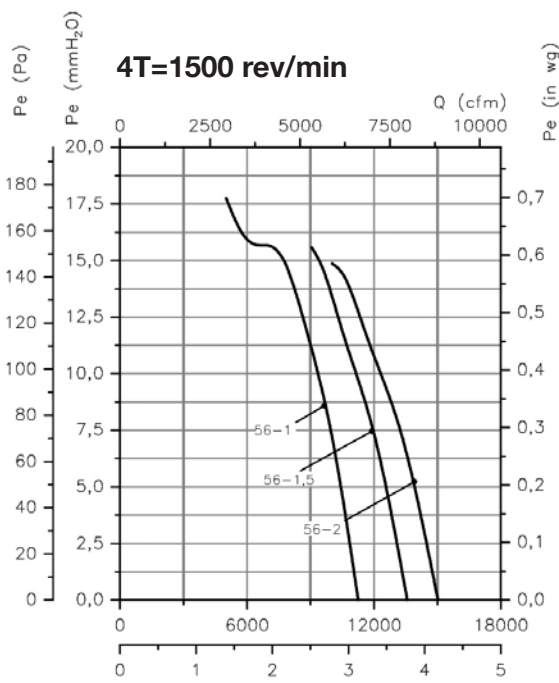

Curvas características

Q= Caudal en m³/h, m³/s y cfm.

Pe= Presión estática en mmH₂O, Pa e inwg.

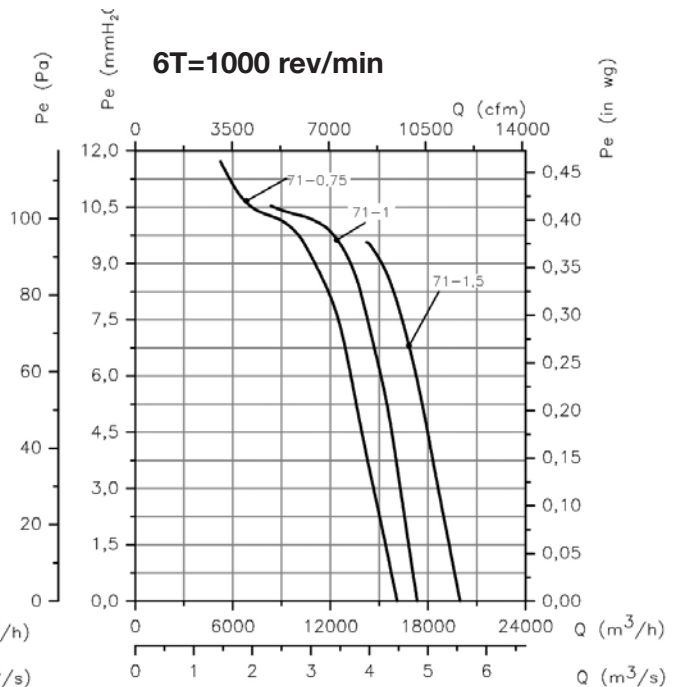
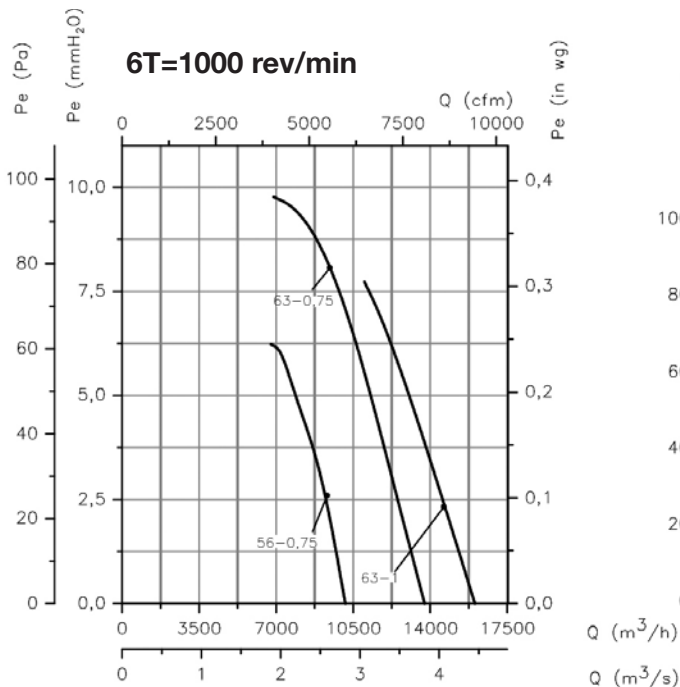
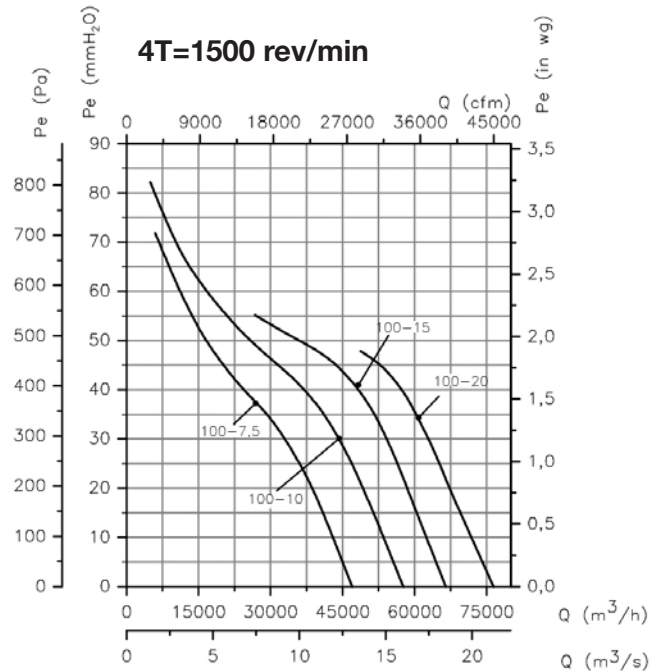
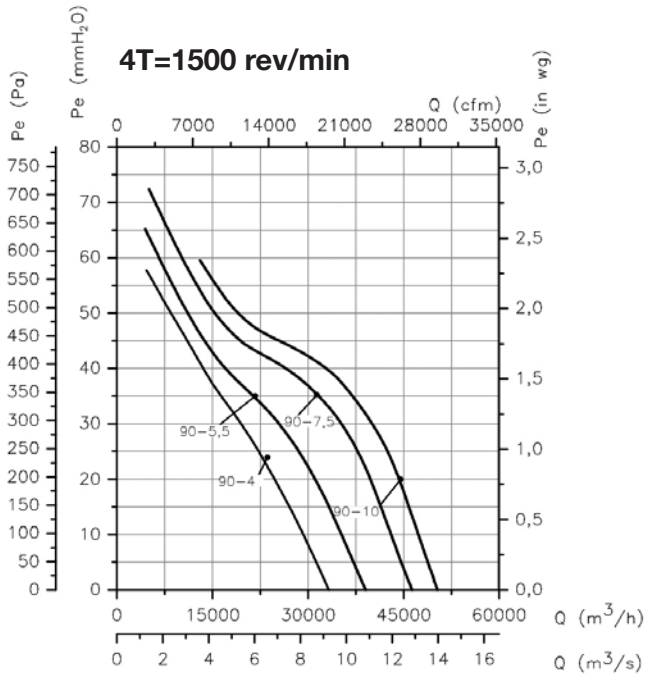

Curvas características

Q= Caudal en m³/h, m³/s y cfm.

Pe= Presión estática en mmH₂O, Pa e inwg.

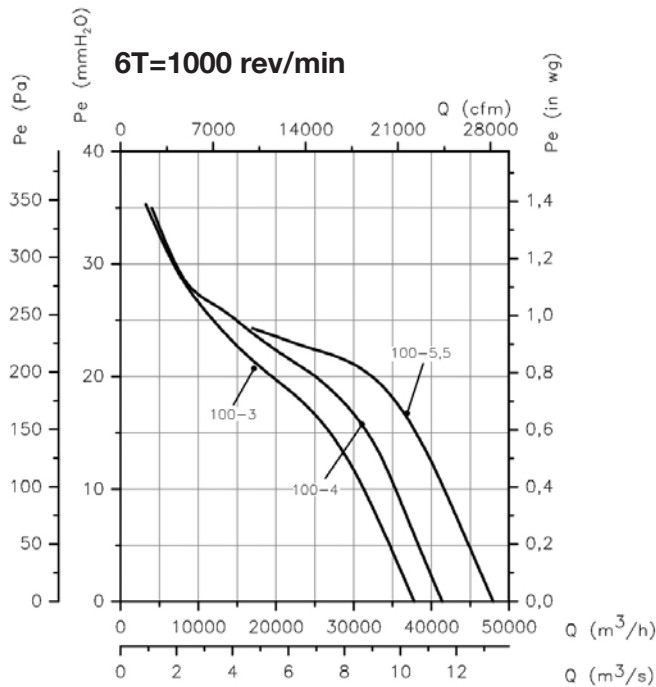
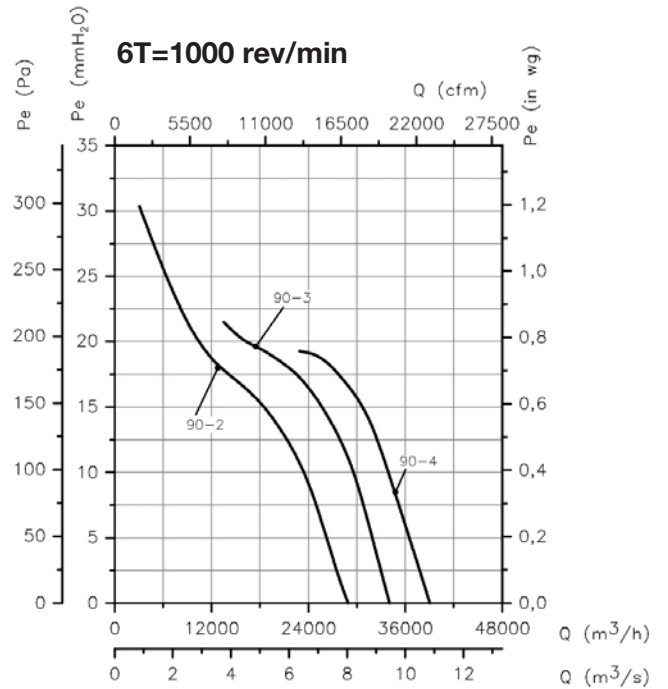
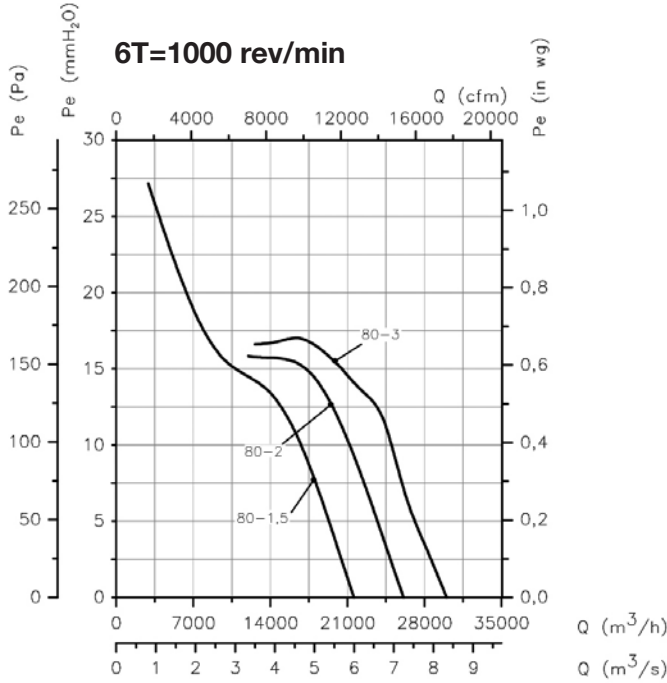

HTP



Hélice de alta presión

Extractores axiales tubulares de alta presión

Extractores axiales tubulares de alta presión y gran robustez, especialmente diseñados para instalaciones de minería o aplicaciones con grandes pérdidas de carga

Ventilador:

- Envoltente tubular en chapa de acero de gran espesor
- Soporte de motor soldado al envoltente.
- Directrices de alto rendimiento aerodinámico para ganancia de presión
- Óptima protección superficial mediante acero de alta calidad.
- Hélice de alto rendimiento, construida en fundición de aluminio
- Sentido de aire hélice-motor
- Conexión eléctrica en caja de bornes externa.

Motor:

- Motores de eficiencia IE3 para potencias iguales o superiores a 0,75kW, excepto monofásicos, 2 velocidades y 8 polos.
- Motores clase F, con rodamientos a bolas, protección IP-55
- Motor Multitensión, diseño especial válido para: 220/380V 60Hz, 254/440V 60Hz, 265/460V 60Hz, 277/480V 60Hz
- Temperatura de trabajo -20°C + 70°C

Acabado:

- Acero de alta protección anticorrosivo, imprimación especial y pintura de alta calidad para ambientes corrosivos.

Bajo demanda:

- Motores normalizados IP-55, motores ATEX y de 2 Velocidades
- Construcción total en acero inoxidable
- Construcción en acero galvanizado en caliente
- Certificación ATEX Categoría 2

Código de pedido

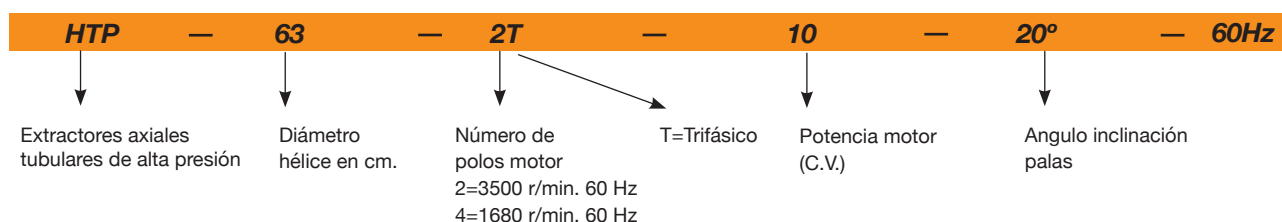

Características técnicas

60Hz

Modelo	Velocidad (r/min)	Intensidad máxima admisible (A)		Potencia instalada (kW)	Caudal máximo (m³/h)	Peso aprox. (Kg)	NPS dB(A)
		220-277V	380-480V				
HTP-50-2T-4	3505	10,09	5,80	3,00	11000	49	82
HTP-50-2T-5,5	3505	13,22	7,60	4,00	13200	65	83
HTP-56-2T-5,5	3505	13,22	7,60	4,00	16600	69	88
HTP-56-2T-10	3505	-	14,00	7,50	22600	147	89
HTP-63-2T-10	3505	-	14,00	7,50	19750	132	94
HTP-63-2T-15	3540	-	19,20	11,00	24150	167	94
HTP-63-2T-20	3540	-	26,00	15,00	30800	181	97
HTP-63-2T-25	3540	-	31,50	18,50	35300	199	98
HTP-63-2T-30	3540	-	39,50	22,00	37550	208	99
HTP-63-4T-1,5	1715	4,17	2,40	1,10	10850	92	79
HTP-63-4T-2	1715	5,74	3,30	1,50	13200	93	79
HTP-63-4T-3	1740	8,00	4,60	2,20	16550	101	83
HTP-63-4T-4	1740	10,96	6,30	3,00	19700	104	84
HTP-71-2T-15	3540	-	19,20	11,00	31750	184	93
HTP-71-2T-20	3540	-	26,00	15,00	36850	198	95
HTP-71-2T-25	3540	-	31,50	18,50	39400	216	95
HTP-71-2T-30	3540	-	39,50	22,00	41950	225	95
HTP-71-2T-40	3540	-	51,60	30,00	49600	303	98
HTP-71-4T-2	1715	5,74	3,30	1,50	16550	110	83
HTP-71-4T-3	1740	8,00	4,60	2,20	19700	118	83
HTP-71-4T-4	1740	10,96	6,30	3,00	22250	121	84
HTP-71-4T-5,5	1740	15,30	8,80	4,00	26050	127	87
HTP-71-4T-7,5	1740	-	11,20	5,50	30100	141	90
HTP-80-4T-4	1740	10,96	6,30	3,00	16250	146	86

Características técnicas

Modelo	Velocidad (r/min)	Intensidad máxima admisible (A)		Potencia instalada (kW)	Caudal máximo (m³/h)	Peso aprox. (Kg)	NPS dB(A)
		220-277V	380-480V				
HTP-80-4T-5,5	1740	15,30	8,80	4,00	19750	152	86
HTP-80-4T-7,5	1740	-	11,20	5,50	23150	166	86
HTP-80-4T-10	1740	-	15,30	7,50	29600	177	87
HTP-80-4T-15	1740	-	20,90	11,00	35550	217	91
HTP-90-4T-7,5	1740	-	11,20	5,50	25400	196	90
HTP-90-4T-10	1740	-	15,30	7,50	29700	207	90
HTP-90-4T-15	1740	-	20,90	11,00	35900	247	90
HTP-90-4T-20	1740	-	28,50	15,00	45050	266	94
HTP-90-4T-25	1775	-	34,50	18,50	47850	294	95
HTP-90-4T-30	1775	-	40,90	22,00	53850	311	97
HTP-100-4T-15	1740	-	20,90	11,00	40950	282	93
HTP-100-4T-20	1740	-	28,50	15,00	50750	301	93
HTP-100-4T-25	1775	-	34,50	18,50	55300	329	93
HTP-100-4T-30	1775	-	40,90	22,00	59350	346	96
HTP-100-4T-40	1775	-	55,30	30,00	71900	401	98
HTP-125-4T-40	1775	-	55,30	30,00	69400	503	100
HTP-125-4T-50	1775	-	68,00	37,00	79650	525	100
HTP-125-4T-60	1775	-	81,30	45,00	89750	558	100
HTP-125-4T-75	1775	-	98,90	55,00	97200	599	100
HTP-125-4T-100	1775	-	135,00	75,00	126050	674	104
HTP-125-4T-125	1775	-	163,00	90,00	144450	703	105

Características acústicas

Los valores indicados, se determinan mediante medidas de nivel de presión y potencia en dB(A), obtenidas en campo libre a una distancia equivalente a dos veces la envergadura del ventilador más el diámetro de la hélice, con un mínimo de 1,5 m

Espectro de potencia sonora Lw(A) en dB(A) por banda de frecuencia en Hz

Modelo	LpdB(A)	63	125	250	500	1000	2000	4000	8000	Modelo	LpdB(A)	63	125	250	500	1000	2000	4000	8000
HTP-50-2T-4	80	57	77	85	90	92	89	82	71	HTP-80-4T-4	86	58	75	86	95	96	96	93	86
HTP-50-2T-5,5	81	58	78	86	91	93	90	83	72	HTP-80-4T-5,5	86	58	76	86	95	96	96	93	86
HTP-56-2T-5,5	86	63	83	91	96	98	95	88	77	HTP-80-4T-7,5	86	58	76	86	95	96	96	93	86
HTP-56-2T-10	87	64	84	92	97	99	96	89	78	HTP-80-4T-10	87	59	77	87	97	98	98	94	88
HTP-63-2T-10	94	70	82	92	104	105	104	99	91	HTP-80-4T-15	91	63	81	91	101	102	102	99	92
HTP-63-2T-15	94	70	82	92	104	105	104	99	91	HTP-90-4T-7,5	90	62	79	90	99	100	100	97	90
HTP-63-2T-20	97	73	85	95	107	108	107	102	94	HTP-90-4T-10	90	62	80	90	99	100	100	97	90
HTP-63-2T-25	98	74	86	96	108	109	108	103	95	HTP-90-4T-15	90	62	80	90	100	101	101	98	91
HTP-63-2T-30	99	75	87	97	109	110	109	104	96	HTP-90-4T-20	94	66	83	94	103	104	104	101	94
HTP-63-4T-1,5	79	55	67	77	89	90	89	84	76	HTP-90-4T-25	95	67	85	95	104	105	105	102	95
HTP-63-4T-2	79	55	67	77	89	90	89	84	76	HTP-90-4T-30	97	69	87	97	107	108	108	104	98
HTP-63-4T-3	83	59	71	81	93	94	93	88	80	HTP-100-4T-15	93	65	83	93	102	103	103	100	93
HTP-63-4T-4	84	60	72	82	94	95	94	89	81	HTP-100-4T-20	93	65	82	93	102	103	103	100	93
HTP-71-2T-15	93	65	83	93	102	104	103	100	93	HTP-100-4T-25	93	65	83	93	102	103	103	100	93
HTP-71-2T-20	95	67	85	95	104	106	105	102	95	HTP-100-4T-30	96	67	85	96	105	106	106	103	96
HTP-71-2T-25	95	67	85	95	104	106	105	102	95	HTP-100-4T-40	98	70	88	98	107	108	108	105	98
HTP-71-2T-30	95	67	85	95	104	106	105	102	95	HTP-125-4T-40	100	72	89	100	109	110	110	107	100
HTP-71-2T-40	98	70	88	98	107	109	108	105	98	HTP-125-4T-50	100	72	90	100	109	110	110	107	100
HTP-71-4T-2	83	55	73	83	92	93	93	90	83	HTP-125-4T-60	100	72	89	100	109	110	110	107	100
HTP-71-4T-3	83	55	72	83	92	93	93	90	83	HTP-125-4T-75	100	72	90	100	110	111	111	108	101
HTP-71-4T-4	84	56	74	84	94	95	95	91	85	HTP-125-4T-100	104	76	93	104	113	114	114	111	104
HTP-71-4T-5,5	87	59	77	87	97	98	98	95	88	HTP-125-4T-125	105	77	95	105	114	115	115	112	105
HTP-71-4T-7,5	90	62	80	90	100	101	101	97	91										

Dimensiones mm

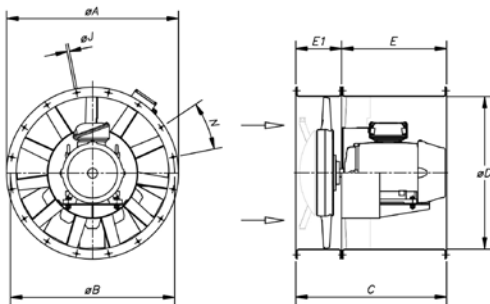

Modelo	Potencia	ØA	ØB	ØD	E	E1	C	ØJ	N
HTP-50-2T	4/5'5	600	560	514	-	-	400	12	12x30°
HTP-56-2T	5/5/10	660	620	560	-	-	500	12	12x30°
HTP-63-2T	10/15/20/25/30	730	690	640	650	220	870	13	12x30°
HTP-63-4T	1'5/2/3/4	730	690	640	340	220	560	13	12x30°
HTP-71-2T	15/20/25/30/40	810	770	710	700	240	940	13	16x22°30'
HTP-71-4T	2/3/4/5/5/7/5	810	770	710	420	240	660	13	16x22°30'
HTP-80-4T	4 / 5'5	900	860	800	360	240	600	15	16x22°30'
HTP-80-4T	7'5 / 10 / 15	900	860	800	600	240	840	15	16x22°30'
HTP-90-4T	7'5 / 10	1015	970	900	420	250	670	15	16x22°30'
HTP-90-4T	15 / 20 / 25 / 30	1015	970	900	650	250	900	15	16x22°30'
HTP-100-4T	15 / 20	1115	1070	1000	600	270	870	15	16x22°30'
HTP-100-4T	25 / 30 / 40	1115	1070	1000	700	270	970	15	16x22°30'
HTP-125	40 / 50 / 60 / 75	1365	1320	1250	900	300	1100	15	20x18°
HTP-125	100 / 125	1365	1320	1250	950	300	1250	15	20x18°

EJEMPLO SELECCIÓN

Curvas características

Q= Caudal en m³/h, m³/s y cfm.

Pe= Presión estática en mmH₂O, Pa e inwg.

HTP-63-4T

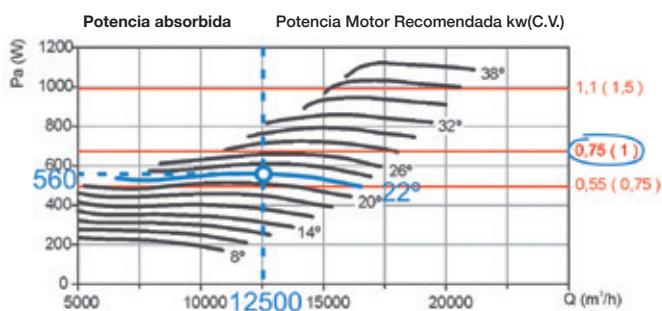
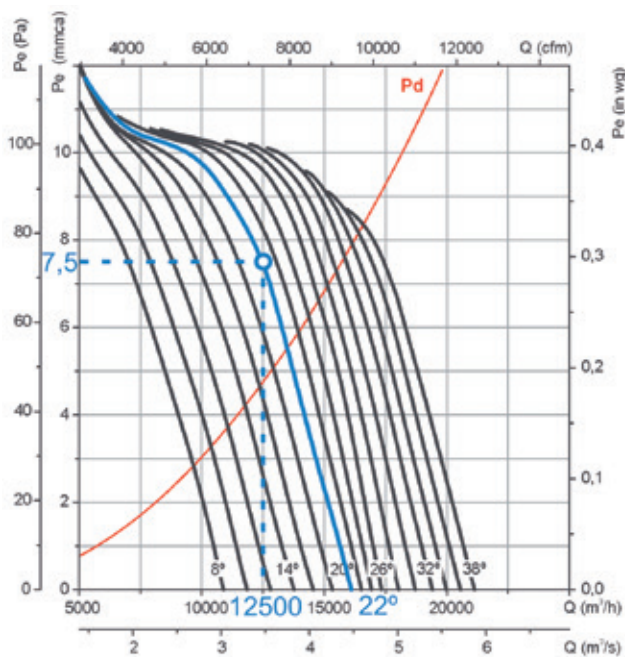

Datos de partida

- Punto de trabajo:
- Caudal: 12.500 m³/h
- Pérdida de carga: 7,5 mmH₂O

Pasos para la selección del equipo

En la gráfica de presiones:

1. Marcar el punto de trabajo, definido por el caudal de trabajo (12.500 m³/h) y la pérdida de carga (7,5 mmH₂O).
2. Escoger la curva del equipo que más se acerque por encima al punto de trabajo. En nuestro caso se obtiene una curva de 22° de ángulo de pala.

En la gráfica de potencia:

3. Marcar el punto de trabajo, definido por el caudal de trabajo (12.500 m³/h) y la curva de ángulo de pala escogido (22°).
4. Leer la potencia absorbida en el eje de potencias a la izquierda. La Pa= 560 W en el punto de trabajo.
5. Buscar recta roja que más se acerque al punto de trabajo por encima. En la parte derecha de la gráfica se obtiene el valor de potencia instalada de motor. En nuestro caso 0,75 kW o 1 C.V..

EJEMPLO CÓDIGO PEDIDO

HTP — **63** — **4T** — **1** — **22°**

↓
Extractores axiales tubulares de alta presión

↓
Diámetro hélice en cm

↓
Número de polos motor
4=1680 r/min. 60 Hz
6=1080 r/min. 60 Hz
8=900 r/min. 60 Hz

↓
T=Trifásico
M=Monofásico

↓
Potencia motor (C.V.)

↓
Angulo inclinación palas

Curvas características

Q= Caudal en m³/h, m³/s y cfm.

Pe= Presión estática en mmH₂O, Pa e inwg.

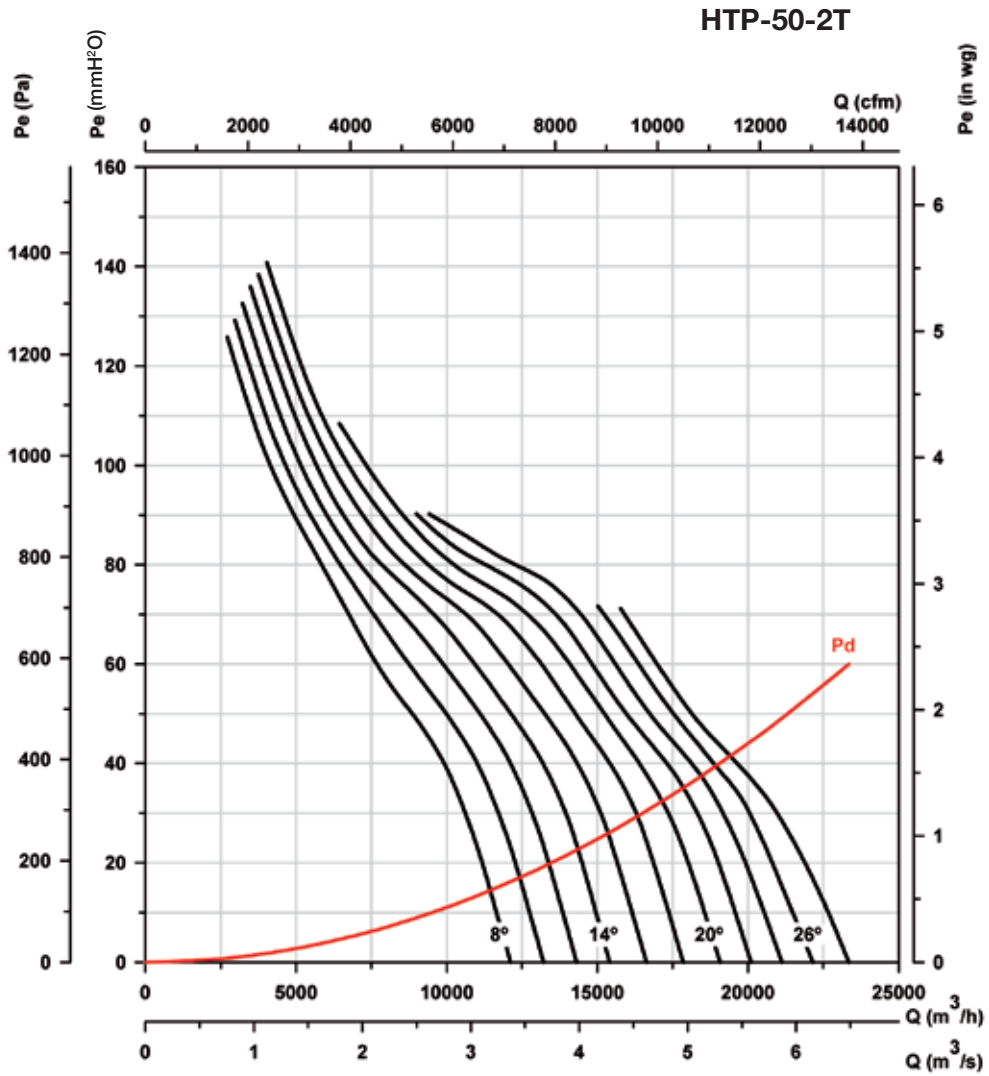

Potencia absorbida

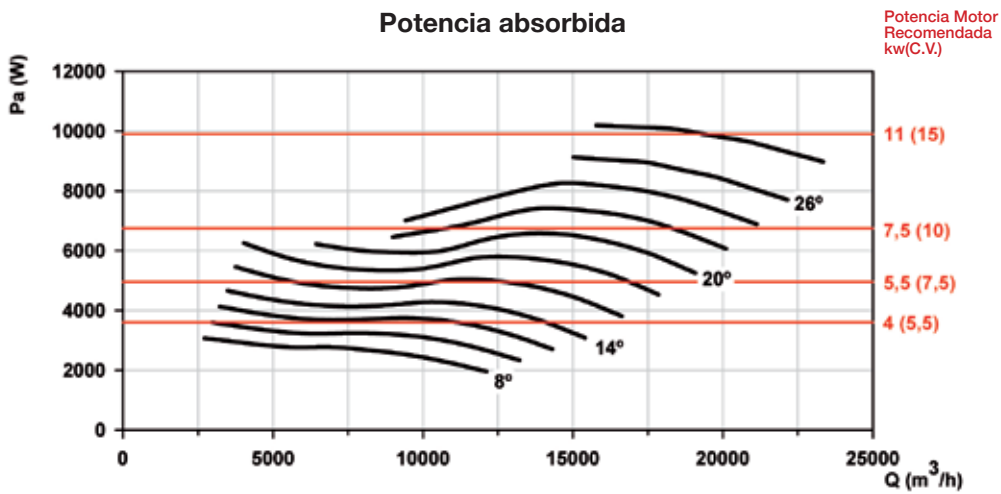

Potencia Motor Recomendada kw(C.V.)

Curvas características

Q= Caudal en m³/h, m³/s y cfm.

Pe= Presión estática en mmH₂O, Pa e inwg.

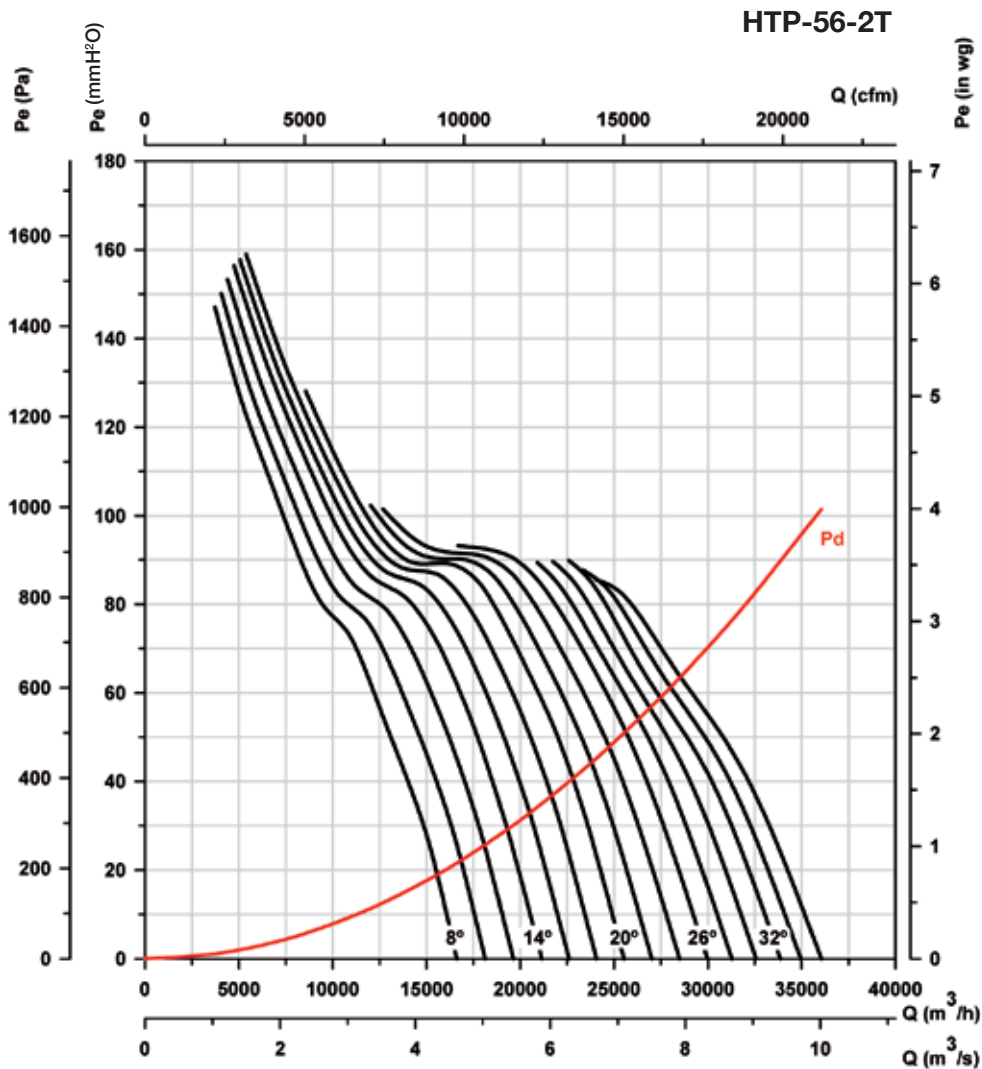

Potencia absorbida

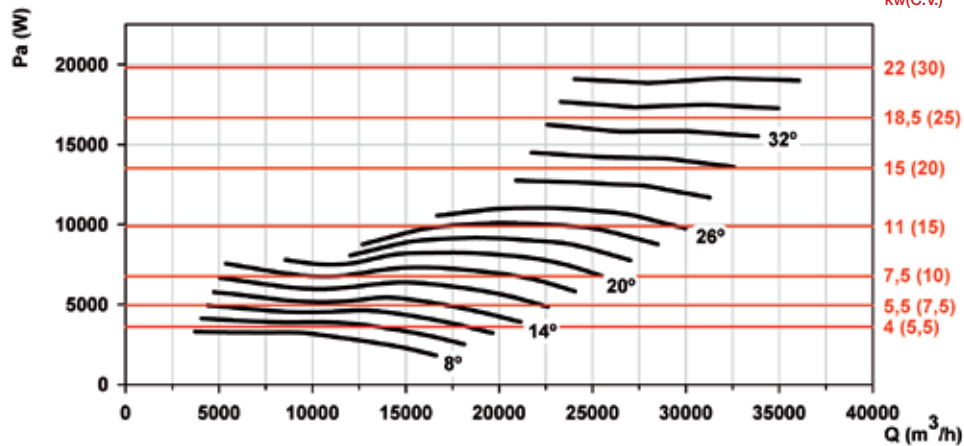

Potencia Motor Recomendada kw(C.V.)

Curvas características

Q= Caudal en m³/h, m³/s y cfm.

Pe= Presión estática en mmH₂O, Pa e inwg.

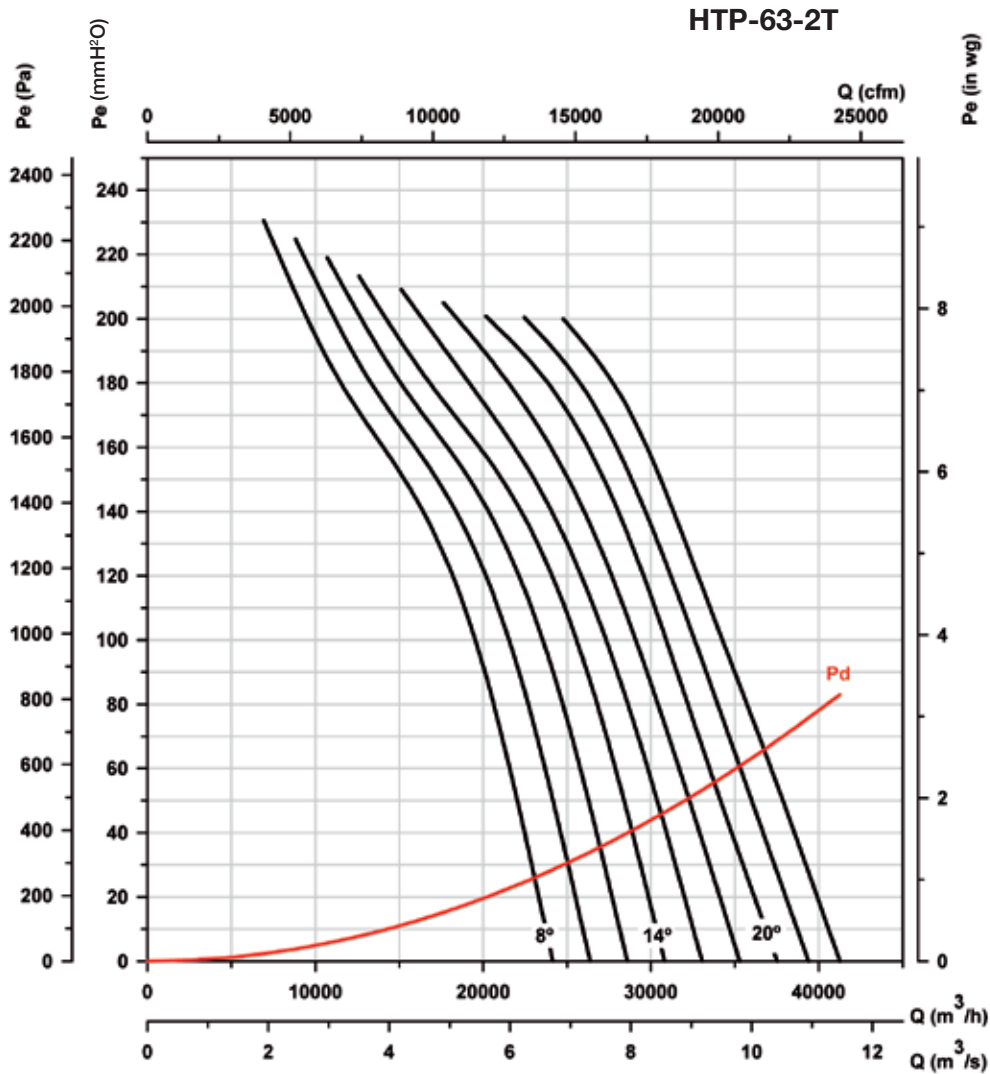

Potencia absorbida

Potencia Motor Recomendada kw(C.V.)

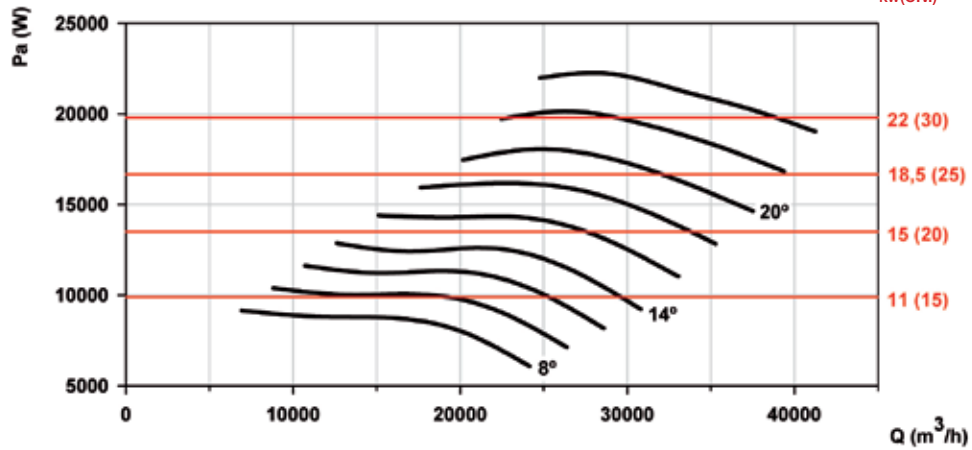

Curvas características

Q= Caudal en m³/h, m³/s y cfm.

Pe= Presión estática en mmH₂O, Pa e inwg.

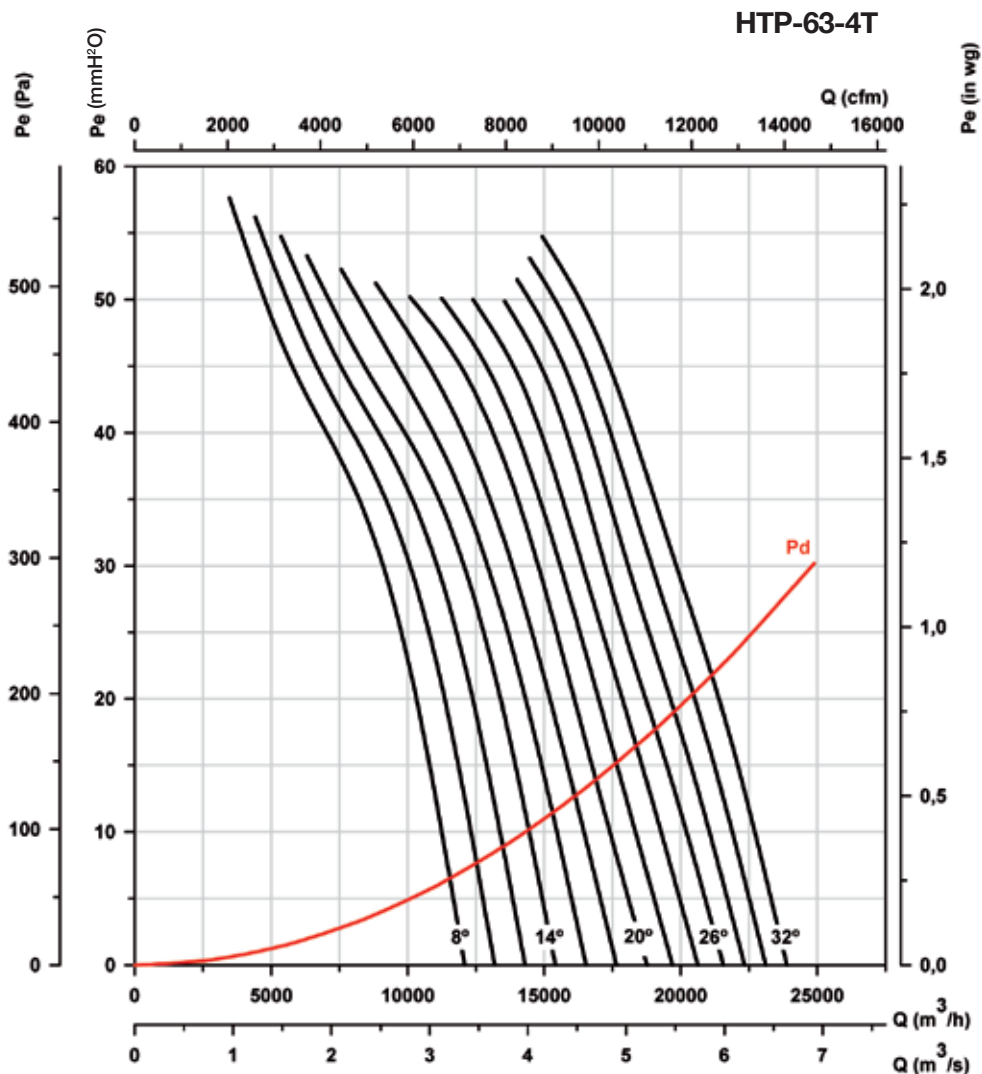

Potencia absorbida

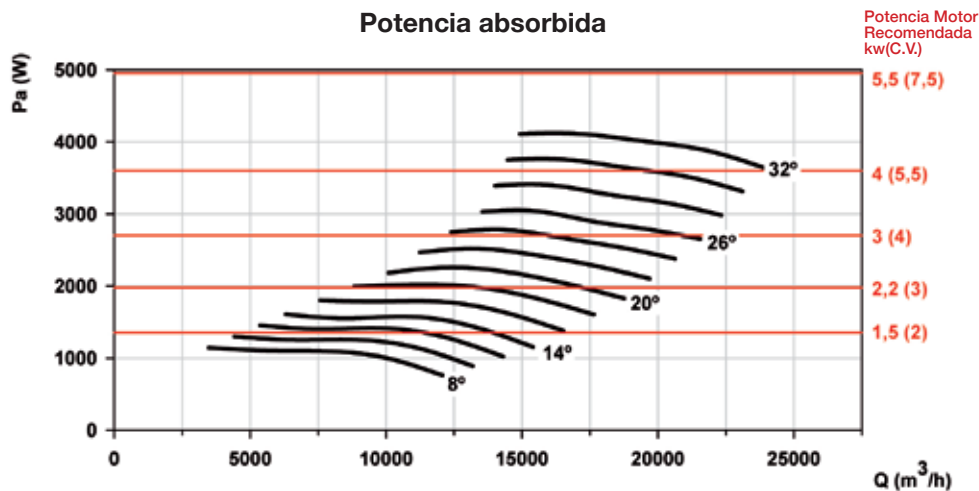

Curvas características

Q= Caudal en m³/h, m³/s y cfm.

Pe= Presión estática en mmH₂O, Pa e inwg.

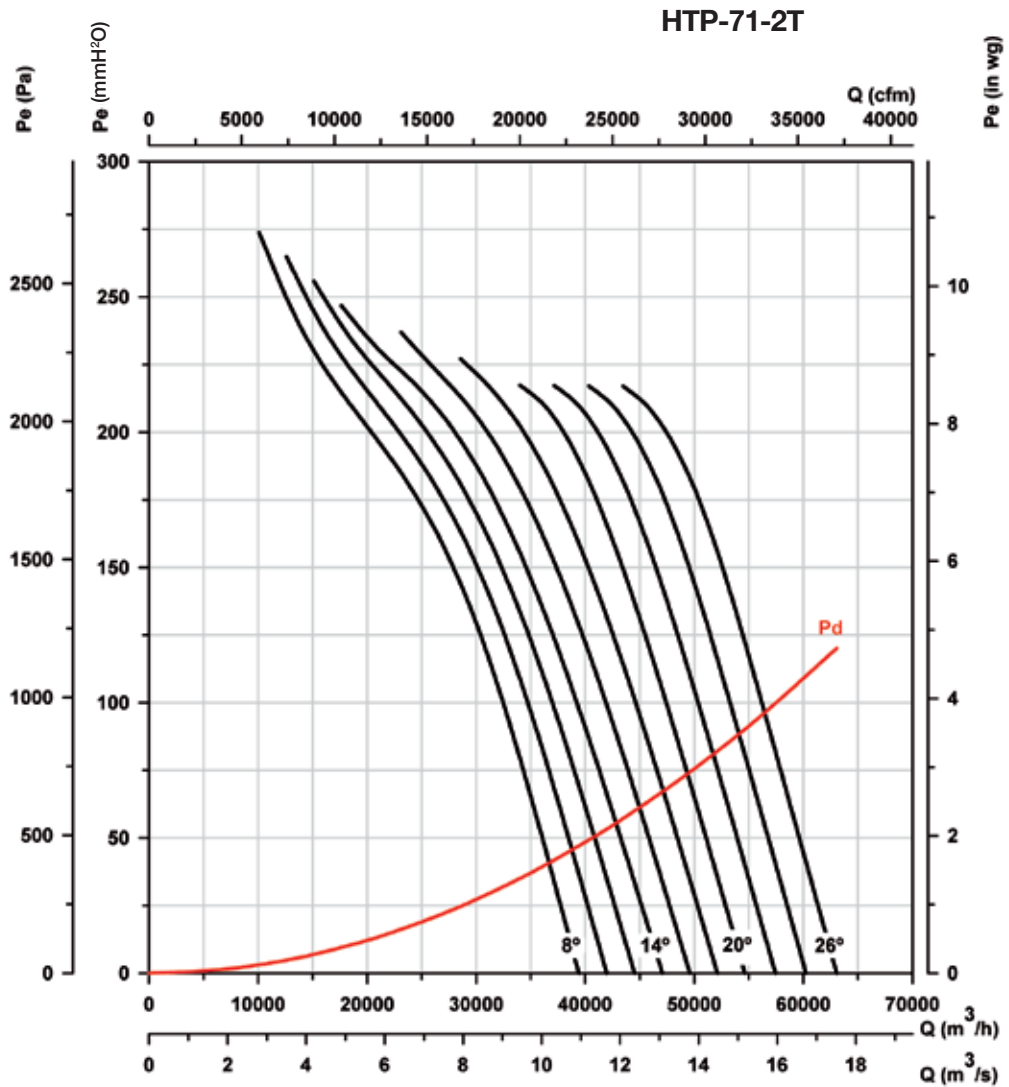

Potencia absorbida

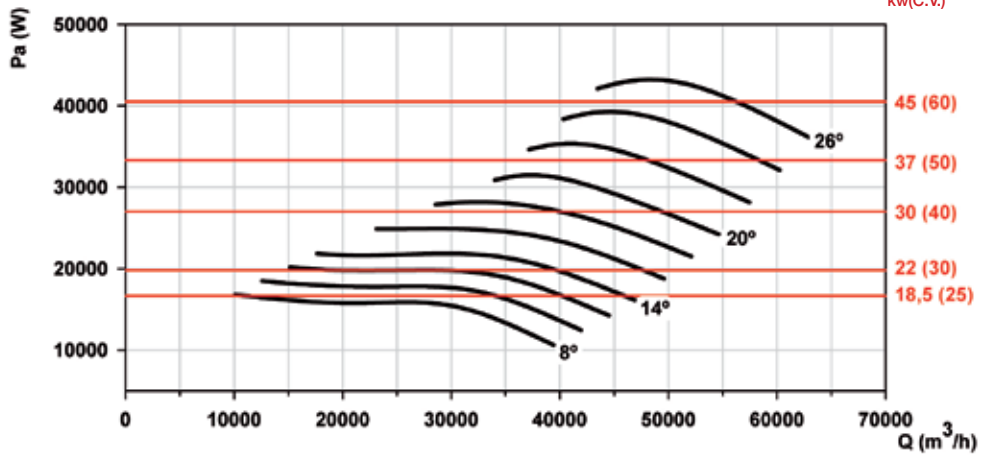

Curvas características

Q= Caudal en m³/h, m³/s y cfm.

Pe= Presión estática en mmH₂O, Pa e inwg.

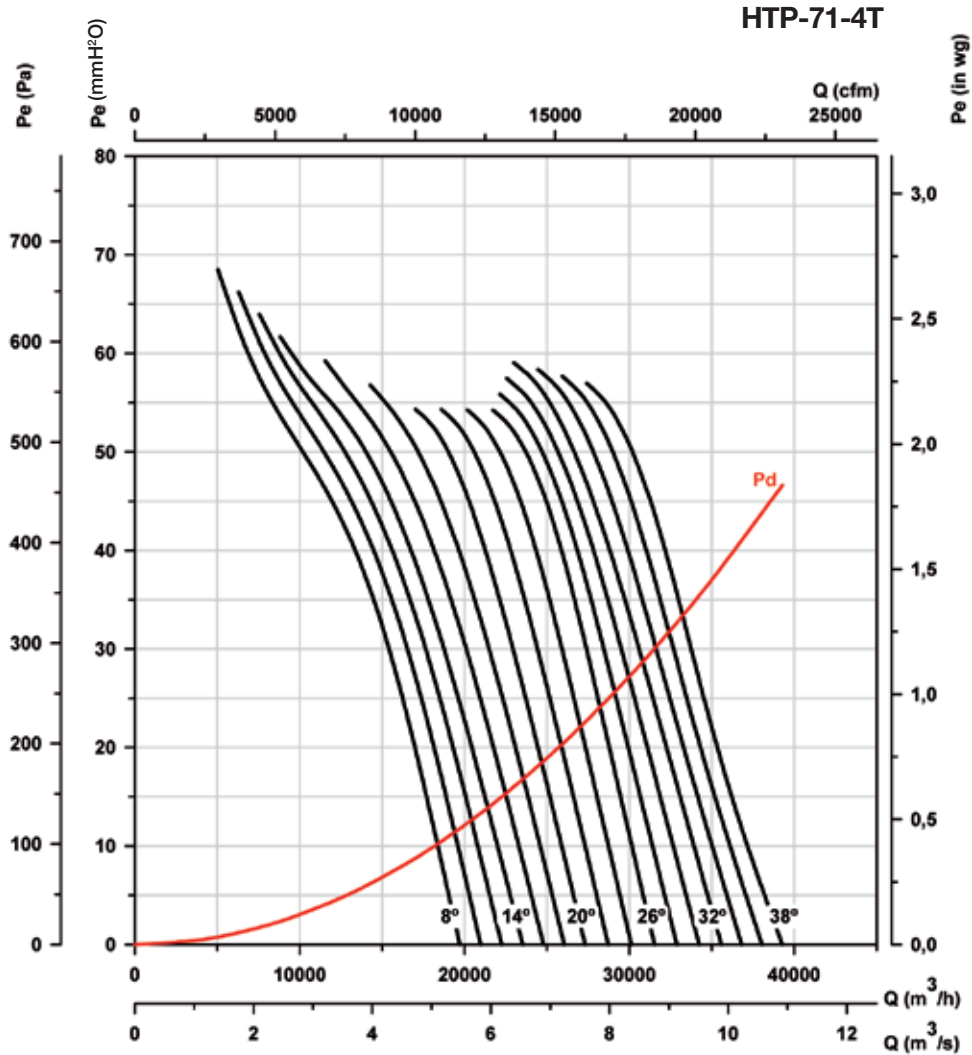

Potencia absorbida

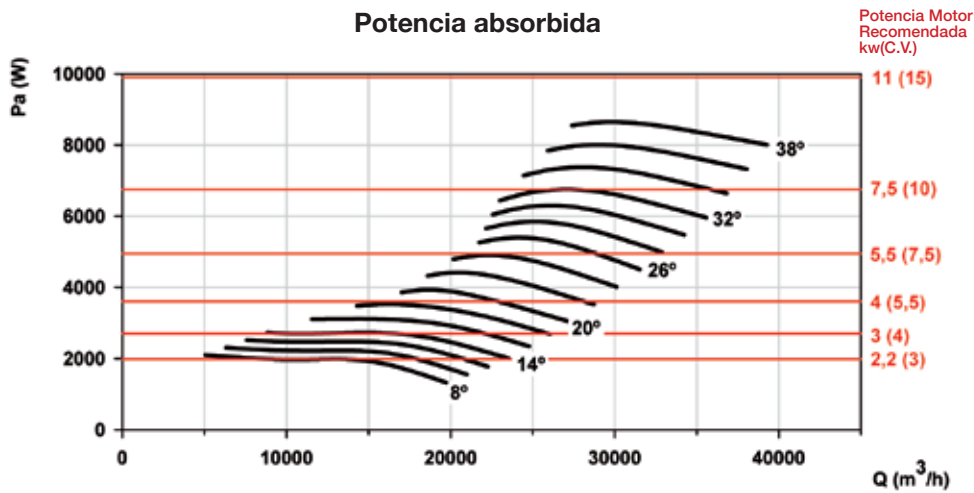

Curvas características

Q= Caudal en m³/h, m³/s y cfm.

Pe= Presión estática en mmH₂O, Pa e inwg.

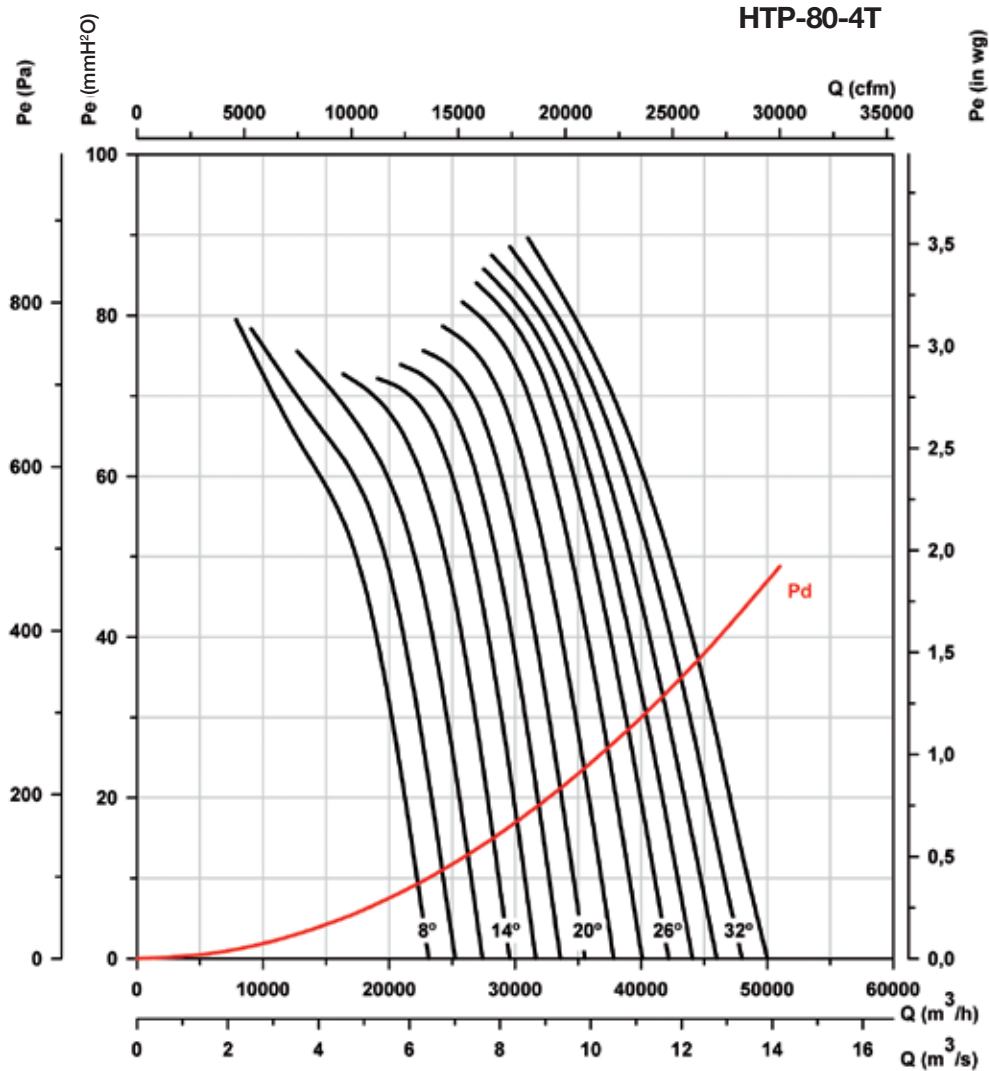

Potencia absorbida

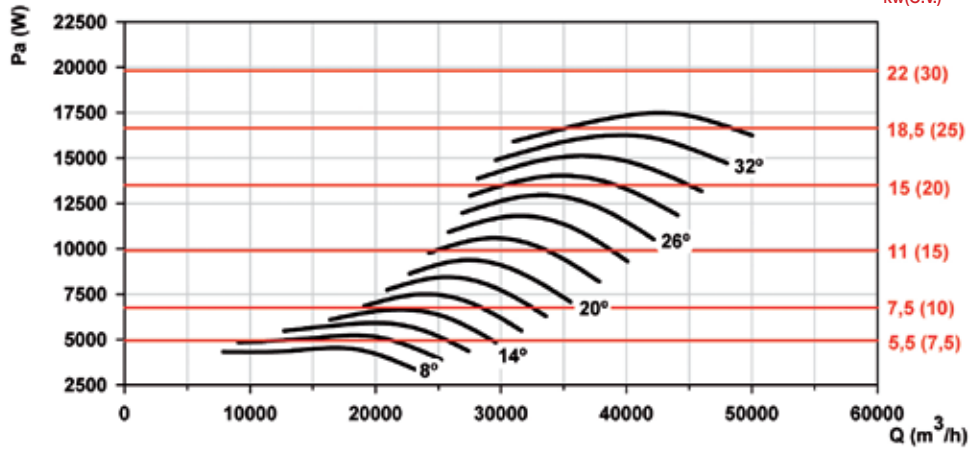

Potencia Motor Recomendada kw(C.V.)

Curvas características

Q= Caudal en m³/h, m³/s y cfm.

Pe= Presión estática en mmH₂O, Pa e inwg.

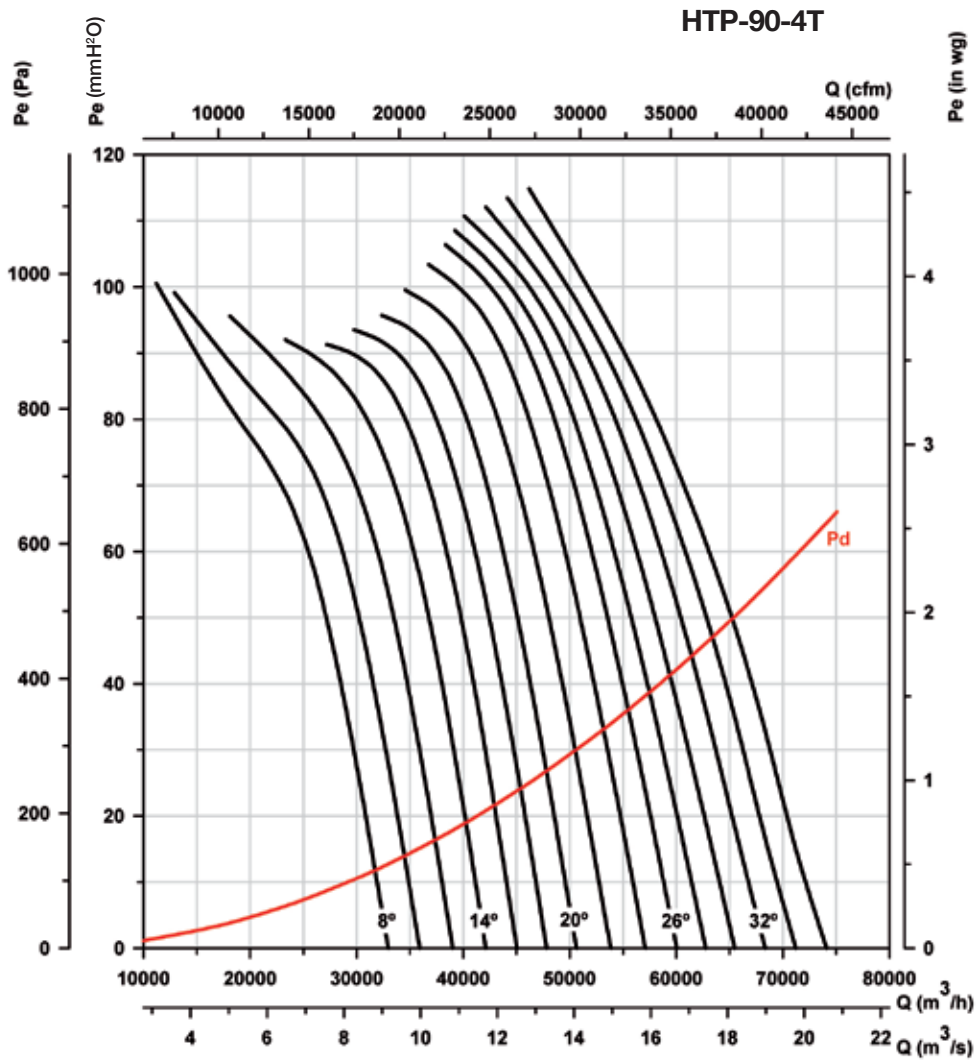

Potencia absorbida

Potencia Motor Recomendada kw(C.V.)

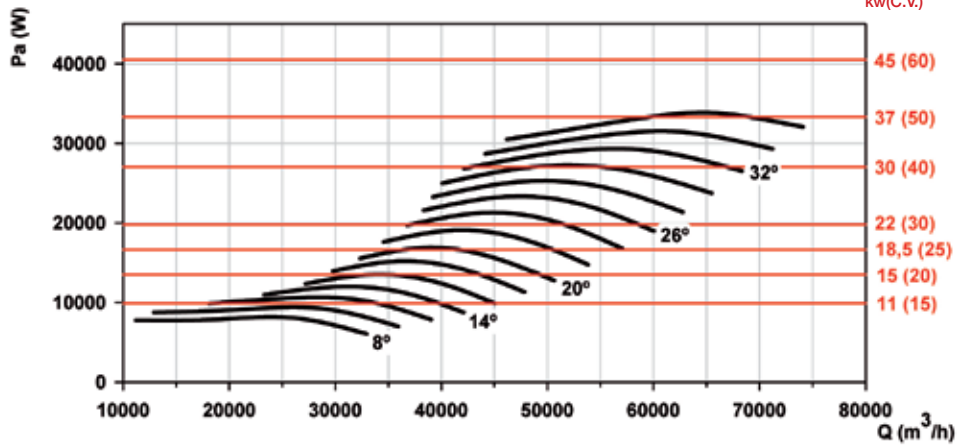

Curvas características

Q= Caudal en m³/h, m³/s y cfm.

Pe= Presión estática en mmH₂O, Pa e inwg.

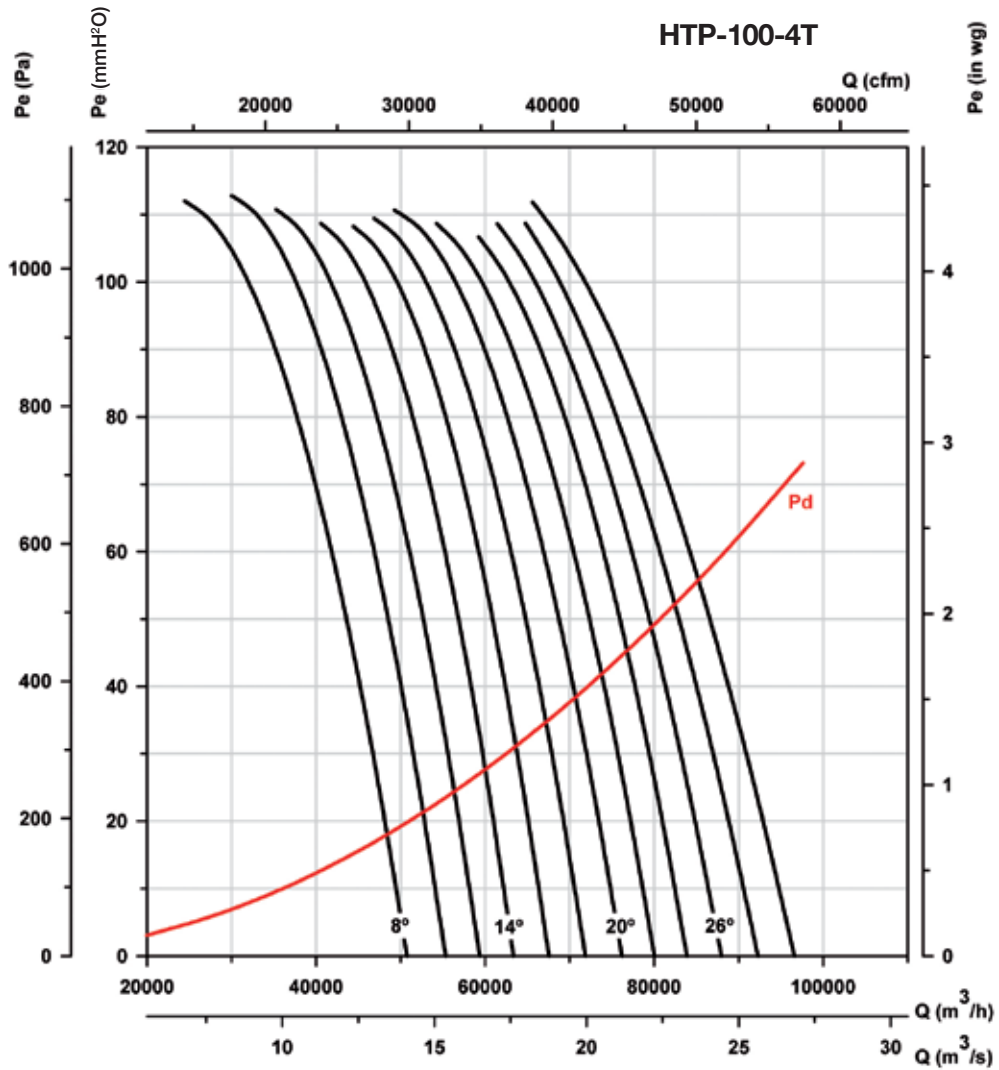

Potencia absorbida

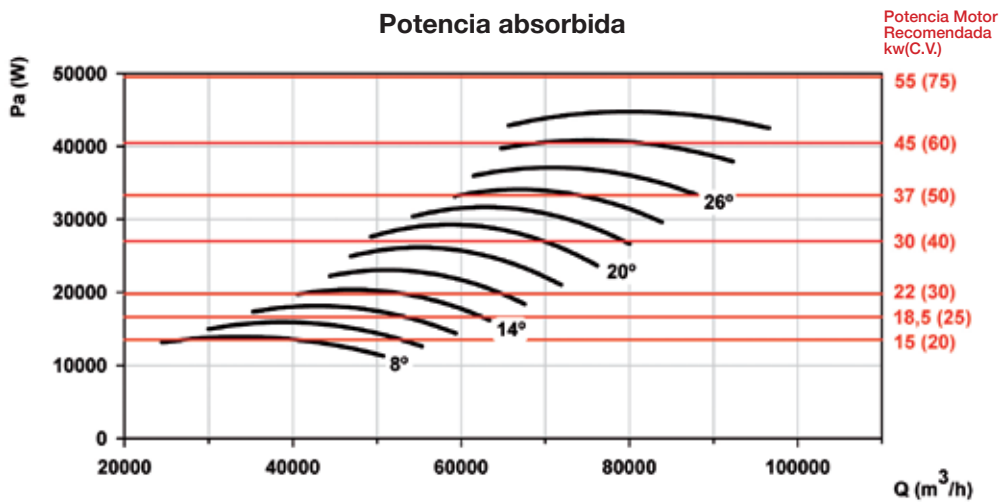

Curvas características

Q= Caudal en m³/h, m³/s y cmf.

Pe= Presión estática en mmH²O, Pa e inwg.

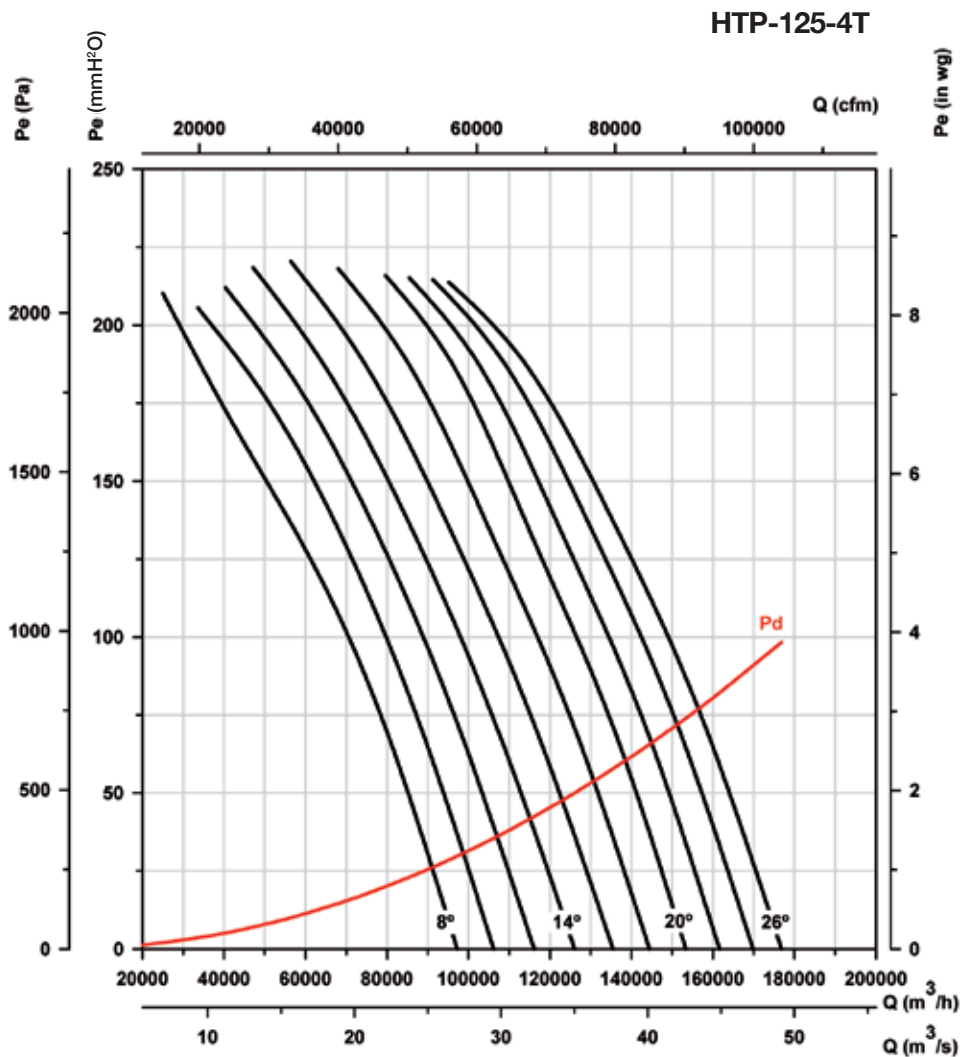

Potencia absorbida

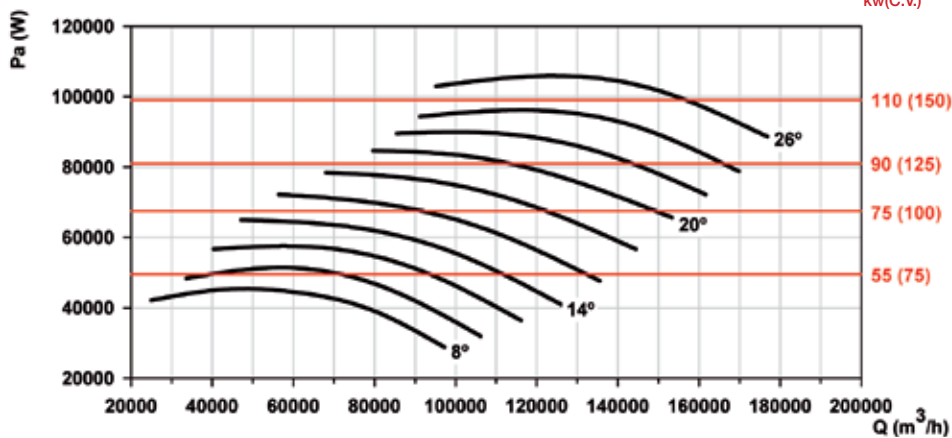

Potencia Motor Recomendada kw(C.V.)

Accesorios

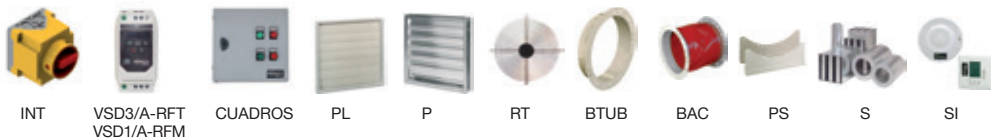

HGT HGTX

HGT: Ventiladores helicoidales tubulares de gran diámetro, con motor directo
HGTX: Ventiladores helicoidales tubulares de gran diámetro, con motor exterior

Ventiladores helicoidales tubulares, equipados con hélices de aluminio de 3, 6 ó 9 álabes con diversos ángulos de inclinación.

Ventilador:

- Dirección aire motor-hélice
- Hélices en fundición de aluminio de 3, 6 ó 9 álabes, con ángulo de inclinación ajustable.
- Envolvente tubular en chapa de acero
- HGT: La versión standard es de carcasa corta. La versión en carcasa larga está equipada con trampilla de inspección.
- HGTX: Versión standard en carcasa larga, equipada con trampilla de inspección



HGT



HGTX

Motor:

- Motores de eficiencia IE3 para potencias iguales o superiores a 0,75kW, excepto monofásicos, 2 velocidades y 8 polos.
- Motores clase F, con rodamientos a bolas, protección IP55
- Motor Multitensión, diseño especial válido para: 220/380V 60Hz, 254/440V 60Hz, 265/460V 60Hz, 277/480V 60Hz
- Temperatura de trabajo: -25°C.+ 50°C (HGT), -25°C.+ 120°C (HGTX)

Acabado:

- Anticorrosivo en resina de poliéster polimerizada a 190 °C, previo desengrase con tratamiento nanotecnológico libre de fosfatos.

Bajo demanda:

- Dirección aire hélice-motor.
- Hélices reversibles 100%.
- Bobinados especiales para diferentes tensiones.
- Certificación ATEX Categoría 2
- HGT: Ventiladores con carcasa larga equipada con trampilla de inspección
- Motores de dos velocidades

Código de pedido

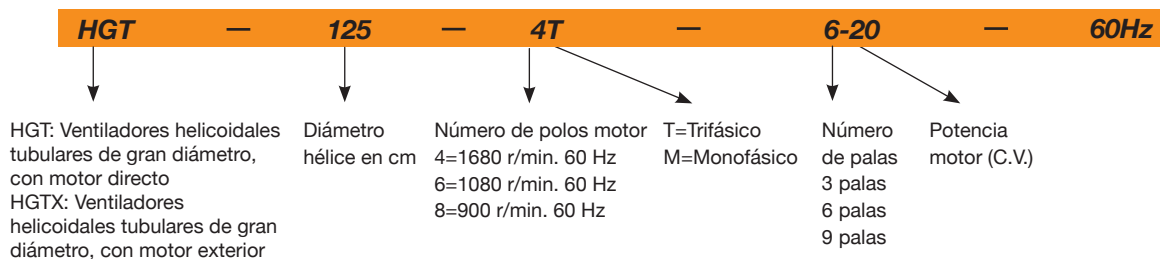

Características técnicas

60Hz

Modelo	Velocidad (r/min)	Intensidad máx admisible (A)		Potencia instalada (kW)	Caudal máximo (m³/h)	Nivel presión sonora dB(A)	Peso aprox. (Kg)		
		220-277V	380-480V				HGT Larga	HGT Corta	HGTX
HGT-125-4T/3-10	HGTX-125-4T/3-10	1740	13,90	7,50	58150	88	227	194	358
HGT-125-4T/3-15	HGTX-125-4T/3-15	1750	20,90	11,00	77450	89	274	246	394
HGT-125-4T/3-20	HGTX-125-4T/3-20	1745	27,90	15,00	91400	91	285	257	405
HGT-125-4T/3-25	HGTX-125-4T/3-25	1765	35,10	18,50	98350	91	363	320	450
HGT-125-4T/3-30	HGTX-125-4T/3-30	1765	41,00	22,00	110500	92	363	320	450
HGT-125-4T/3-40	HGTX-125-4T/3-40	1770	57,10	30,00	120850	93	468	425	557
HGT-125-4T/3-50	HGTX-125-4T/3-50	1775	69,20	37,00	129000	94	551	495	622
HGT-125-4T/3-60	HGTX-125-4T/3-60	1775	80,90	45,00	140000	95	589	533	660
HGT-125-4T/6-20	HGTX-125-4T/6-20	1745	27,90	15,00	78300	89	294	266	414
HGT-125-4T/6-25	HGTX-125-4T/6-25	1765	35,10	18,50	92000	90	372	329	459
HGT-125-4T/6-30	HGTX-125-4T/6-30	1765	41,00	22,00	98100	90	372	329	459
HGT-125-4T/6-40	HGTX-125-4T/6-40	1770	57,10	30,00	117000	92	477	433	566
HGT-125-4T/6-50	HGTX-125-4T/6-50	1775	69,20	37,00	123700	93	560	504	631
HGT-125-4T/6-60	HGTX-125-4T/6-60	1775	80,90	45,00	136000	94	598	542	669
HGT-125-4T/6-75	HGTX-125-4T/6-75	1775	98,60	55,00	148000	95	614	564	700
HGT-125-4T/6-100	HGTX-125-4T/6-100	1775	134,00	75,00	161000	96	708	658	794
HGT-125-4T/9-25	HGTX-125-4T/9-25	1765	35,10	18,50	79750	88	381	338	468
HGT-125-4T/9-30	HGTX-125-4T/9-30	1765	41,00	22,00	97000	89	381	338	468

Características técnicas

Modelo	Velocidad (r/min)	Intensidad máx admisible (A)		Potencia instalada (kW)	Caudal máximo (m³/h)	Nivel presión sonora dB(A)	Peso aprox. (Kg)		HGTX
		220-277V	380-480V				HGT Larga	HGT Corta	
HGT-125-4T/9-40	HGTX-125-4T/9-40	1770	57,10	30,00	111200	91	486	442	575
HGT-125-4T/9-50	HGTX-125-4T/9-50	1775	69,20	37,00	118350	93	569	513	640
HGT-125-4T/9-60	HGTX-125-4T/9-60	1775	80,90	45,00	127000	94	607	551	678
HGT-125-4T/9-75	HGTX-125-4T/9-75	1775	98,60	55,00	142000	95	623	573	709
HGT-125-4T/9-100	HGTX-125-4T/9-100	1775	134,00	75,00	155000	99	717	667	803
HGT-125-6T/3-4	HGTX-125-6T/3-4	1120	12,70	7,33	46550	79	204	171	335
HGT-125-6T/3-5,5	HGTX-125-6T/3-5,5	1130	16,50	9,53	55300	80	209	176	340
HGT-125-6T/3-7,5	HGTX-125-6T/3-7,5	1145	11,50	5,50	64450	81	217	184	348
HGT-125-6T/3-10	HGTX-125-6T/3-10	1165	14,80	7,50	76400	83	297	269	417
HGT-125-6T/3-15	HGTX-125-6T/3-15	1165	21,90	11,00	87050	84	298	270	418
HGT-125-6T/3-20	HGTX-125-6T/3-20	1165	28,20	15,00	91700	85	407	364	494
HGT-125-6T/6-5,5	HGTX-125-6T/6-5,5	1130	16,50	9,53	51300	77	218	185	349
HGT-125-6T/6-7,5	HGTX-125-6T/6-7,5	1145	11,50	5,50	60300	77	226	193	357
HGT-125-6T/6-10	HGTX-125-6T/6-10	1165	14,80	7,50	72250	79	306	278	426
HGT-125-6T/6-15	HGTX-125-6T/6-15	1165	21,90	11,00	85450	81	307	279	427
HGT-125-6T/6-20	HGTX-125-6T/6-20	1165	28,20	15,00	92850	82	416	373	503
HGT-125-6T/6-25	HGTX-125-6T/6-25	1180	35,90	18,50	103000	84	449	405	538
HGT-125-6T/9-10	HGTX-125-6T/9-10	1165	14,80	7,50	68200	78	315	287	435
HGT-125-6T/9-15	HGTX-125-6T/9-15	1165	21,90	11,00	77550	81	316	288	436
HGT-125-6T/9-20	HGTX-125-6T/9-20	1165	28,20	15,00	92900	84	425	382	512
HGT-125-6T/9-25	HGTX-125-6T/9-25	1180	35,90	18,50	98700	85	458	414	547
HGT-125-6T/9-30	HGTX-125-6T/9-30	1175	42,40	22,00	104000	87	463	419	552
HGT-125-8T/3-3	HGTX-125-8T/3-3	865	9,53	5,50	48800	71	209	176	340
HGT-125-8T/3-4	HGTX-125-8T/3-4	865	12,82	7,40	54900	71	216	183	347
HGT-125-8T/3-5,5	HGTX-125-8T/3-5,5	860	16,11	9,30	62100	73	249	221	369
HGT-125-8T/3-7,5	HGTX-125-8T/3-7,5	850	12,70	5,50	69500	75	262	234	382
HGT-125-8T/6-3	HGTX-125-8T/6-3	865	9,53	5,50	45700	69	218	185	349
HGT-125-8T/6-4	HGTX-125-8T/6-4	865	12,82	7,40	51800	71	225	192	356
HGT-125-8T/6-5,5	HGTX-125-8T/6-5,5	860	16,11	9,30	61500	72	258	230	378
HGT-125-8T/6-7,5	HGTX-125-8T/6-7,5	850	12,70	5,50	67500	73	271	243	391
HGT-125-8T/6-10	HGTX-125-8T/6-10	860	17,00	7,50	75500	75	301	273	421
HGT-125-8T/9-4	HGTX-125-8T/9-4	865	12,82	7,40	48200	70	234	201	365
HGT-125-8T/9-5,5	HGTX-125-8T/9-5,5	860	16,11	9,30	55200	73	267	239	387
HGT-125-8T/9-7,5	HGTX-125-8T/9-7,5	850	12,70	5,50	67000	75	280	252	400
HGT-125-8T/9-10	HGTX-125-8T/9-10	860	17,00	7,50	74750	76	310	282	430
HGT-125-8T/9-15	HGTX-125-8T/9-15	865	21,70	11,00	80800	79	372	329	459
HGT-140-6T/3-4		1150	12,70	7,33	51000	82	251	214	
HGT-140-6T/3-5,5		1150	16,50	9,53	56700	83	258	221	
HGT-140-6T/3-7,5		1145	11,50	5,50	67900	84	266	229	
HGT-140-6T/3-10		1165	14,80	7,50	80100	85	355	316	
HGT-140-6T/3-15		1165	21,90	11,00	96900	86	356	317	
HGT-140-6T/3-20		1165	28,20	15,00	106000	88	463	413	
HGT-140-6T/6-5,5		1150	16,50	9,53	58000	82	268	231	
HGT-140-6T/6-7,5		1145	11,50	5,50	66000	84	276	239	
HGT-140-6T/6-10		1165	14,80	7,50	80700	85	365	326	
HGT-140-6T/6-15		1165	21,90	11,00	96700	86	366	327	
HGT-140-6T/6-20		1165	28,20	15,00	104000	87	472	423	
HGT-140-6T/6-25		1180	35,90	18,50	115000	88	506	457	
HGT-140-6T/6-30		1175	42,40	22,00	119000	89	511	462	
HGT-140-6T/9-10		1165	14,80	7,50	70000	84	374	335	
HGT-140-6T/9-15		1165	21,90	11,00	86000	86	375	336	
HGT-140-6T/9-20		1165	28,20	15,00	97500	87	482	432	
HGT-140-6T/9-25		1180	35,90	18,50	111000	88	515	467	
HGT-140-6T/9-30		1175	42,40	22,00	118500	89	520	472	
HGT-140-6T/9-40		1180	55,40	30,00	132000	91	676	614	
HGT-140-6T/9-50		1180	67,20	37,00	139000	92	693	638	
HGT-140-8T/3-3		865	9,53	5,50	50000	78	258	221	
HGT-140-8T/3-4		865	12,82	7,40	57000	78	265	228	

Características técnicas

Modelo	Velocidad (r/min)	Intensidad máx admisible (A)		Potencia instalada (kW)	Caudal máximo (m³/h)	Nivel presión sonora dB(A)	Peso aprox. (Kg)	
		220-277V	380-480V				HGT Larga	HGTX Corta
HGT-140-8T/3-5,5	860	16,11	9,30	4,00	65400	79	307	268
HGT-140-8T/3-7,5	850		12,70	5,50	77500	81	320	281
HGT-140-8T/3-10	860		17,00	7,50	86000	82	350	311
HGT-140-8T/6-3	865	9,53	5,50	2,20	47500	78	268	231
HGT-140-8T/6-4	865	12,82	7,40	3,00	57600	79	275	238
HGT-140-8T/6-5,5	860	16,11	9,30	4,00	65200	80	317	278
HGT-140-8T/6-7,5	850		12,70	5,50	73300	81	330	291
HGT-140-8T/6-10	860		17,00	7,50	82200	82	360	321
HGT-140-8T/6-15	865		21,70	11,00	94200	83	419	370
HGT-140-8T/9-4	865	12,82	7,40	3,00	47200	79	284	247
HGT-140-8T/9-5,5	860	16,11	9,30	4,00	64400	79	326	287
HGT-140-8T/9-7,5	850		12,70	5,50	69200	81	339	300
HGT-140-8T/9-10	860		17,00	7,50	78700	82	369	330
HGT-140-8T/9-15	865		21,70	11,00	94300	83	429	379
HGT-140-8T/9-20	890		31,70	15,00	103000	86	485	437
HGT-160-6T/3-5,5	1150	16,50	9,53	4,00	66000	81	327	275
HGT-160-6T/3-7,5	1145		11,50	5,50	76100	82	335	283
HGT-160-6T/3-10	1165		14,80	7,50	84000	83	428	374
HGT-160-6T/3-15	1165		21,90	11,00	102000	85	429	375
HGT-160-6T/3-20	1165		28,20	15,00	127000	86	549	480
HGT-160-6T/3-25	1180		35,90	18,50	136700	87	583	513
HGT-160-6T/3-30	1175		42,40	22,00	145000	89	588	518
HGT-160-6T/6-10	1165		14,80	7,50	75000	83	439	385
HGT-160-6T/6-15	1165		21,90	11,00	93500	85	440	386
HGT-160-6T/6-20	1165		28,20	15,00	120500	86	559	490
HGT-160-6T/6-25	1180		35,90	18,50	130000	87	593	524
HGT-160-6T/6-30	1175		42,40	22,00	140000	88	598	529
HGT-160-6T/6-40	1180		55,40	30,00	158000	89	771	672
HGT-160-6T/6-50	1180		67,20	37,00	171000	91	784	699
HGT-160-6T/9-15	1165		21,90	11,00	87000	85	450	396
HGT-160-6T/9-20	1165		28,20	15,00	104000	86	569	500
HGT-160-6T/9-25	1180		35,90	18,50	127000	87	603	534
HGT-160-6T/9-30	1175		42,40	22,00	135000	88	608	539
HGT-160-6T/9-40	1180		55,40	30,00	147000	89	781	682
HGT-160-6T/9-50	1180		67,20	37,00	165000	90	794	710
HGT-160-6T/9-60	1180		84,40	45,00	177000	91	1019	920
HGT-160-6T/9-75	1190		103,00	55,00	193000	92	1077	978
HGT-160-6T/9-100	1190		139,00	75,00	207500	93	1232	1133
HGT-160-8T/3-3	865	9,53	5,50	2,20	54000	76	327	275
HGT-160-8T/3-4	865	12,82	7,40	3,00	57500	77	334	282
HGT-160-8T/3-5,5	860	16,11	9,30	4,00	74000	79	380	326
HGT-160-8T/3-7,5	850		12,70	5,50	83500	80	393	339
HGT-160-8T/3-10	860		17,00	7,50	97500	81	423	369
HGT-160-8T/3-15	865		21,70	11,00	115000	83	496	427
HGT-160-8T/6-4	865	12,82	7,40	3,00	70900	76	344	292
HGT-160-8T/6-5,5	860	16,11	9,30	4,00	84500	77	391	337
HGT-160-8T/6-7,5	850		12,70	5,50	77000	79	404	350
HGT-160-8T/6-10	860		17,00	7,50	95000	80	434	380
HGT-160-8T/6-15	865		21,70	11,00	109000	82	506	437
HGT-160-8T/6-20	890		31,70	15,00	123000	83	563	494
HGT-160-8T/6-25	875		35,85	18,50	130000	84	641	542
HGT-160-8T/9-7,5	850		12,70	5,50	70000	79	414	360
HGT-160-8T/9-10	860		17,00	7,50	87000	80	444	390
HGT-160-8T/9-15	865		21,70	11,00	103000	82	516	447
HGT-160-8T/9-20	890		31,70	15,00	117000	83	573	504
HGT-160-8T/9-25	875		35,85	18,50	133000	84	651	552
HGT-160-8T/9-30	875		41,60	22,00	140000	85	666	567
HGT-160-8T/9-40	880		60,79	30,00	151000	86	724	640

Dimensiones mm

HGT

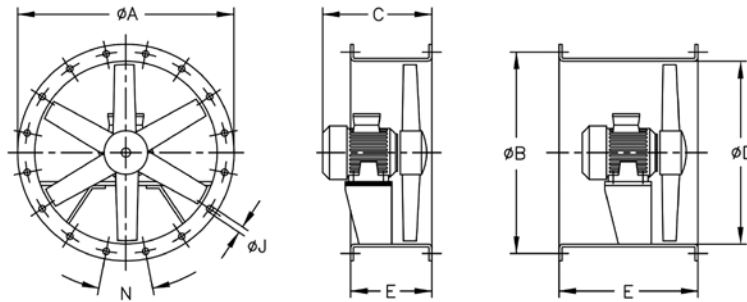

Modelo	ØA	ØB	C (Consultar tamaño constructivo motor)							ØD	E*		ØJ	N
			132	160	180	200	225	250	280		Corta (STD)	larga		
HGT-125	1365	1320	586	-	-	-	-	-	-	1250	500	700	15	20x18°
HGT-125	1365	1320	-	700	-	-	-	-	-	1250	500	700	15	20x18°
HGT-125	1365	1320	-	-	765	825	-	-	-	1250	700	900	15	20x18°
HGT-125	1365	1320	-	-	-	-	910	-	-	1250	700	1000	15	20x18°
HGT-125	1365	1320	-	-	-	-	-	985	-	1250	700	1000	15	20x18°
HGT-125	1365	1320	-	-	-	-	-	-	1190	1250	700	1200	15	20x18°
HGT-140	1515	1470	586	-	-	-	-	-	-	1400	400	650	15	20x18°
HGT-140	1515	1470	-	700	-	-	-	-	-	1400	450	700	15	20x18°
HGT-140	1515	1470	-	-	765	825	-	-	-	1400	550	900	15	20x18°
HGT-140	1515	1470	-	-	-	-	910	-	-	1400	550	1000	15	20x18°
HGT-140	1515	1470	-	-	-	-	-	985	-	1400	600	1000	15	20x18°
HGT-160	1735	1680	586	-	-	-	-	-	-	1600	400	650	19	24x15°
HGT-160	1735	1680	-	700	-	-	-	-	-	1600	450	700	19	24x15°
HGT-160	1735	1680	-	-	765	825	-	-	-	1600	550	900	19	24x15°
HGT-160	1735	1680	-	-	-	-	910	-	-	1600	550	1000	19	24x15°
HGT-160	1735	1680	-	-	-	-	-	985	-	1600	600	1000	19	24x15°
HGT-160	1735	1680	-	-	-	-	-	-	1190	1600	700	1200	19	24x15°

* Versión estándar suministrada en carcasa corta. Bajo demanda carcasa larga con trampilla de inspección.

Tamaños constructivos motores según potencia

Polos	r/min	CV	3	4	5,5	7,5	10	15	20	25	30	40	50	60	75	100
4T	1500	-	-	-	-	-	132	160	160	180	180	200	225	225	250	280
6T	1000	-	132	132	132	160	160	180	200	200	225	250	280	280	280	-
8T	750	-	132	132	160	160	160	180	200	225	225	250	-	-	-	-

HGTX

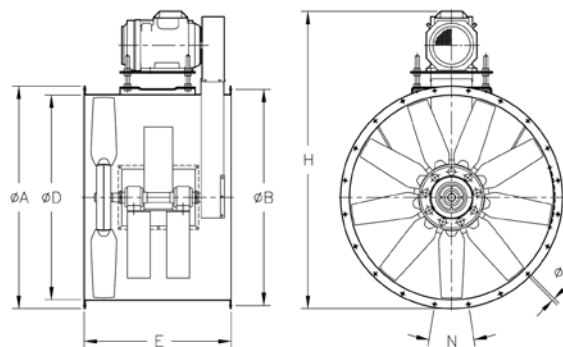

Modelo	ØA	ØB	ØD	E	H (Consultar tamaño constructivo motor)							ØJ	N
					132	160	180	200	225	250	280		
HGT-X 125	1365	1320	1250	900	1743	1815	1850	-	-	-	-	15	20x18°
HGT-X 125	1365	1320	1250	960	-	-	-	1930	1995	-	-	15	20x18°
HGT-X 125	1365	1320	1250	1100	-	-	-	-	-	2060	-	15	20x18°
HGT-X 125	1365	1320	1250	1100	-	-	-	-	-	-	2090	15	20x18°

Tamaños constructivos motores según potencia

Polos	r/min	CV	3	4	5,5	7,5	10	15	20	25	30	40	50	60	75	100
4T	1500	-	-	-	-	-	132	160	160	180	180	200	225	225	250	280
6T	1000	-	132	132	132	160	160	180	200	200	225	250	280	280	280	-
8T	750	-	132	132	160	160	160	180	200	225	225	250	-	-	-	-

EJEMPLO SELECCIÓN

Curvas características

Q= Caudal en m³/h, m³/s y cfm.

Pe= Presión estática en mmH₂O, Pa e inwg.

Diámetro Hélice (cm): 125

Número de polos: 8

Número de palas: 3

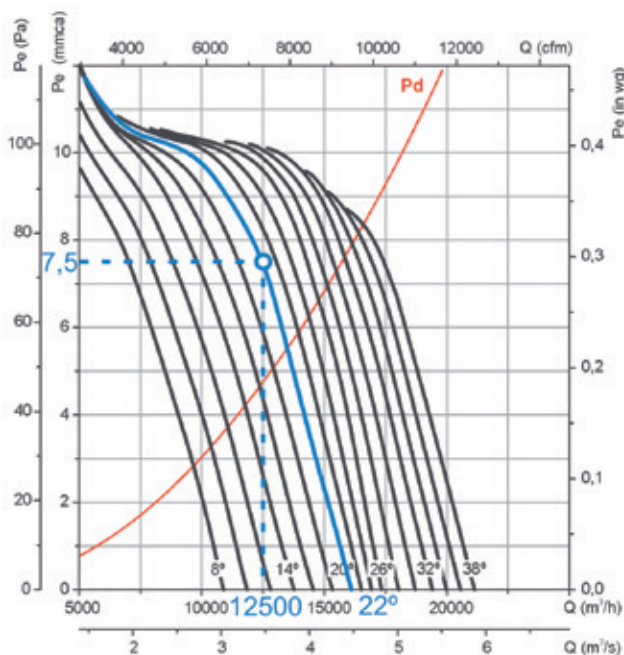

Datos de partida

- Punto de trabajo:
- Caudal: 12.500 m³/h
- Pérdida de carga: 7,5 mm c.a.

Pasos para la selección del equipo

En la gráfica de presiones:

1. Marcar el punto de trabajo, definido por el caudal de trabajo (12.500 m³/h) y la pérdida de carga (7,5 mmH₂O).
2. Escoger la curva del equipo que más se acerque por encima al punto de trabajo. En nuestro caso se obtiene una curva de 22° de ángulo de pala.

En la gráfica de potencia:

3. Marcar el punto de trabajo, definido por el caudal de trabajo (12.500 m³/h) y la curva de ángulo de pala escogido (22°).
4. Leer la potencia absorbida en el eje de potencias a la izquierda. La Pa= 560 W en el punto de trabajo.
5. Buscar recta roja que más se acerque al punto de trabajo por encima. En la parte derecha de la gráfica se obtiene el valor de potencia instalada de motor. En nuestro caso 0,75 kW o 1 C.V.

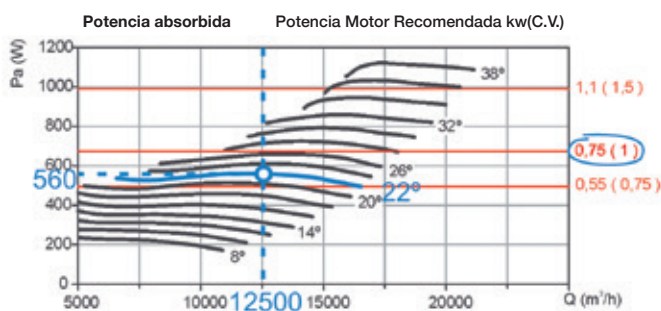

EJEMPLO CÓDIGO PEDIDO

HGT — 125 — 8T — 3 — 1 — 22

HGT: Ventiladores helicoidales tubulares de gran diámetro, con motor directo
 HGTX: Ventiladores helicoidales tubulares de gran diámetro, con motor exterior

Diámetro hélice en cm

Número de polos motor
 4=1680 r/min. 60 Hz
 6=1080 r/min. 60 Hz
 8=900 r/min. 60 Hz

T=Trifásico
 M=Monofásico

Número de palas
 3 palas
 6 palas
 9 palas

Potencia motor (C.V.)

Angulo inclinación palas

Curvas características

Q= Caudal en m³/h, m³/s y cfm.

Pe= Presión estática en mmH²O, Pa e inwg.

Diámetro Hélice (cm): 125

Número de polos: 4

Número de palas: 3

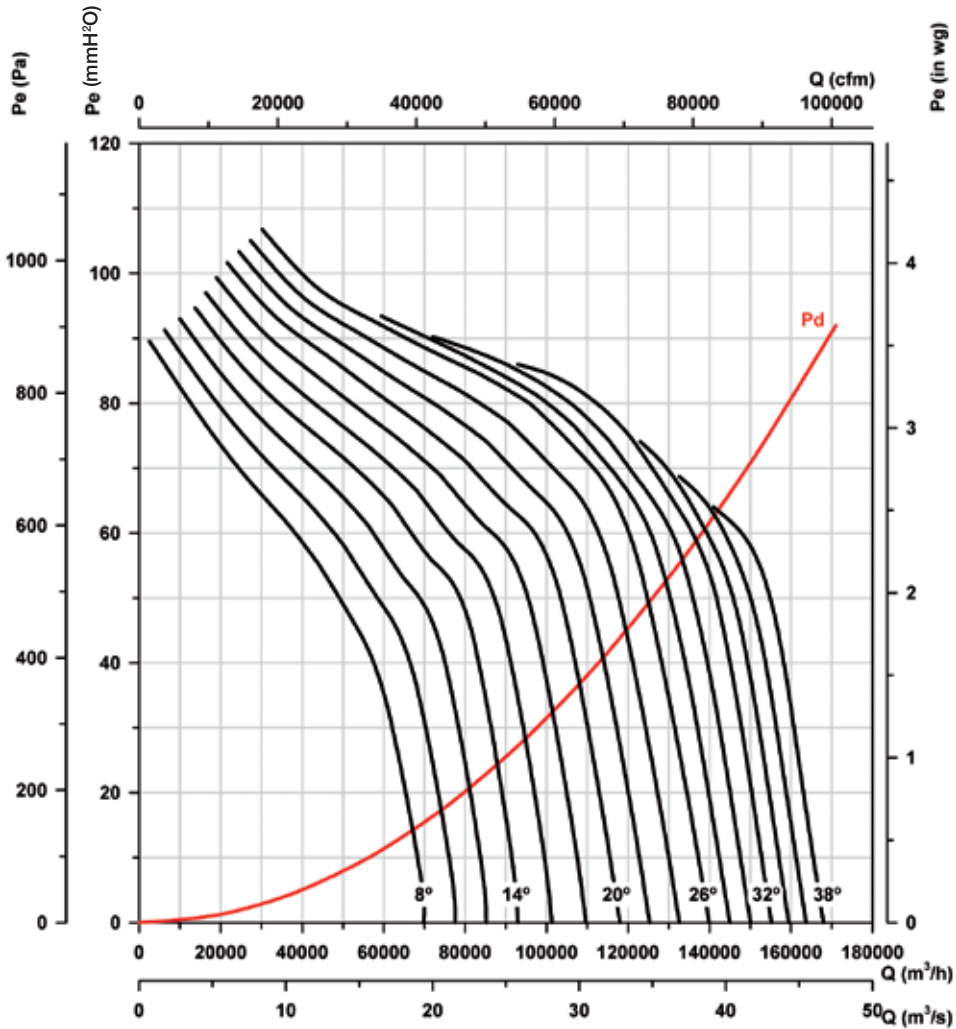

Potencia absorbida

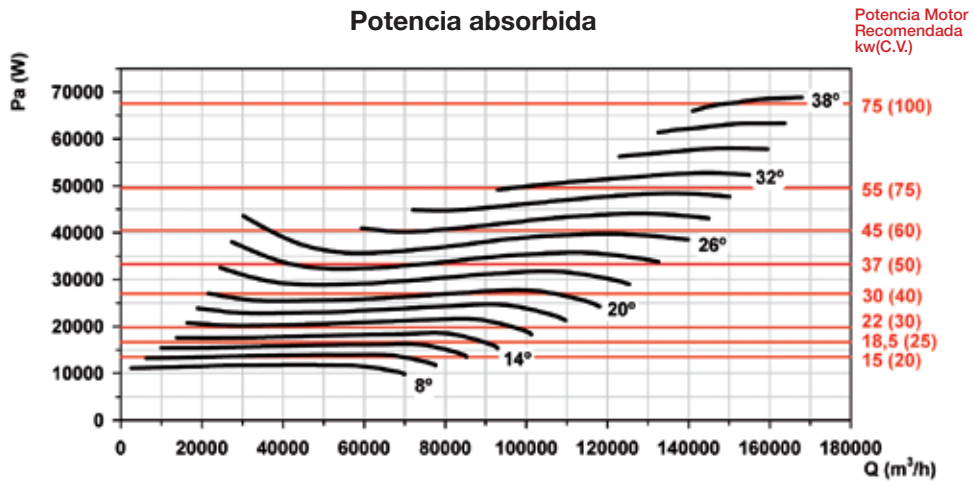

Curvas características

Q= Caudal en m³/h, m³/s y cfm. Pe= Presión estática en mmH₂O, Pa e inwg.

Diámetro Hélice (cm): 125

Número de polos: 4

Número de palas: 6

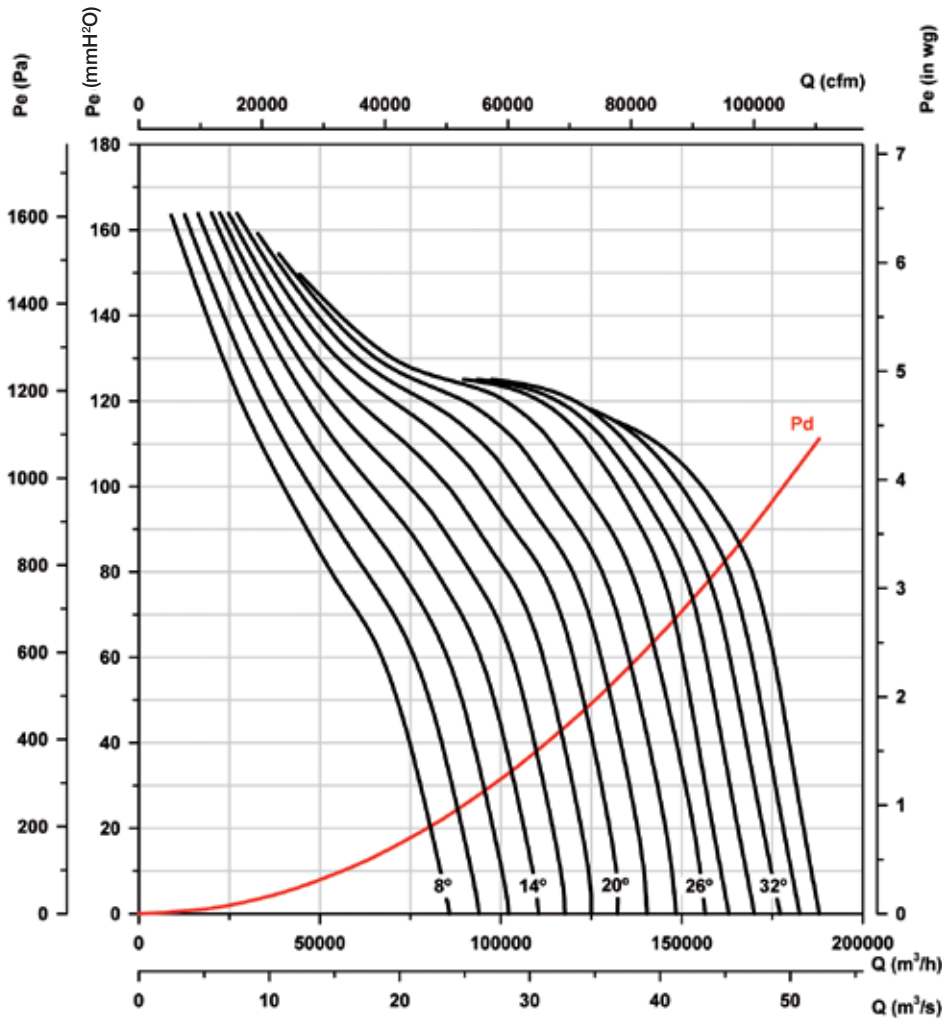

Potencia absorbida

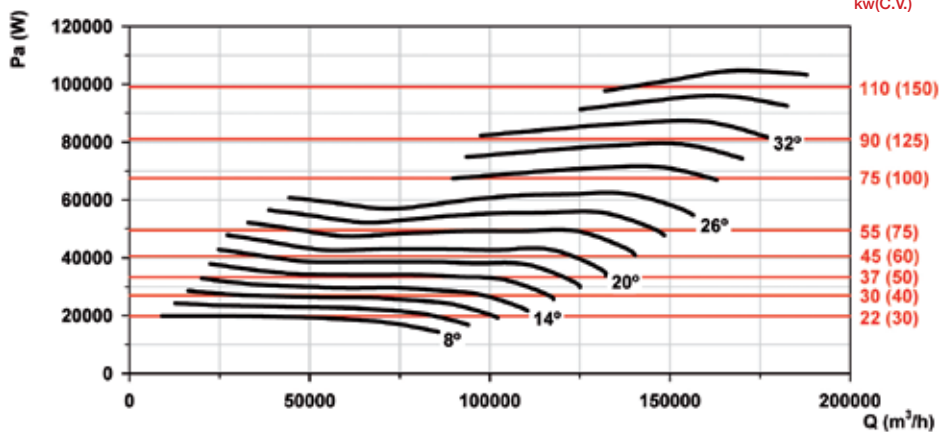

Potencia Motor Recomendada kw(C.V.)

Curvas características

Q= Caudal en m³/h, m³/s y cfm. Pe= Presión estática en mmH₂O, Pa e inwg.

Diámetro Hélice (cm): 125

Número de polos: 4

Número de palas: 9

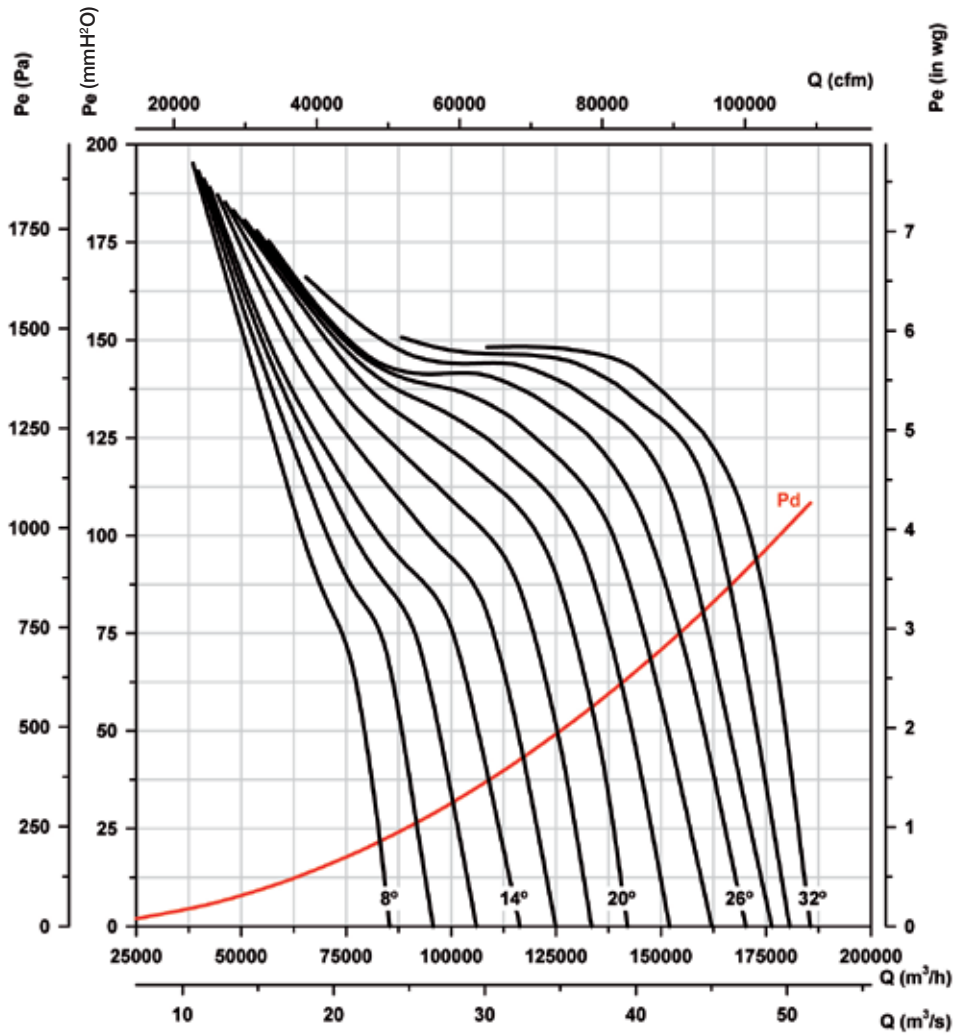

Potencia absorbida

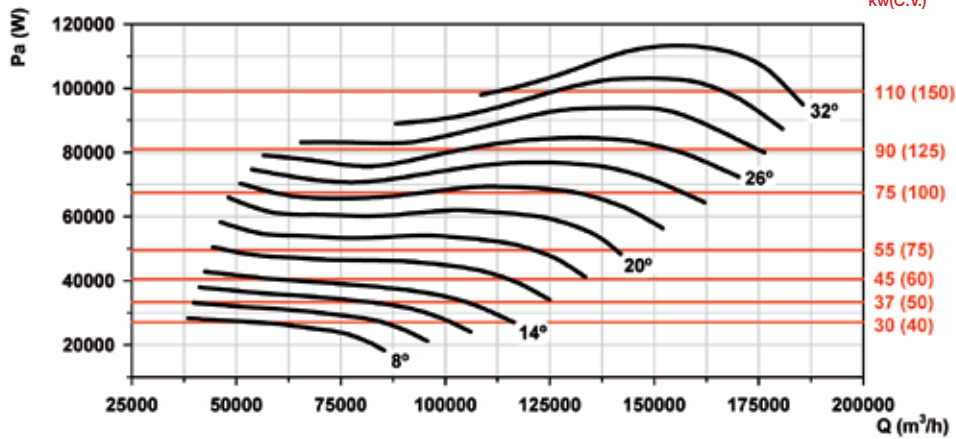

Potencia Motor Recomendada kw(C.V.)

Curvas características

Q= Caudal en m³/h, m³/s y cfm. Pe= Presión estática en mmH²O, Pa e inwg.

Diámetro Hélice (cm): 125

Número de polos: 6

Número de palas: 3

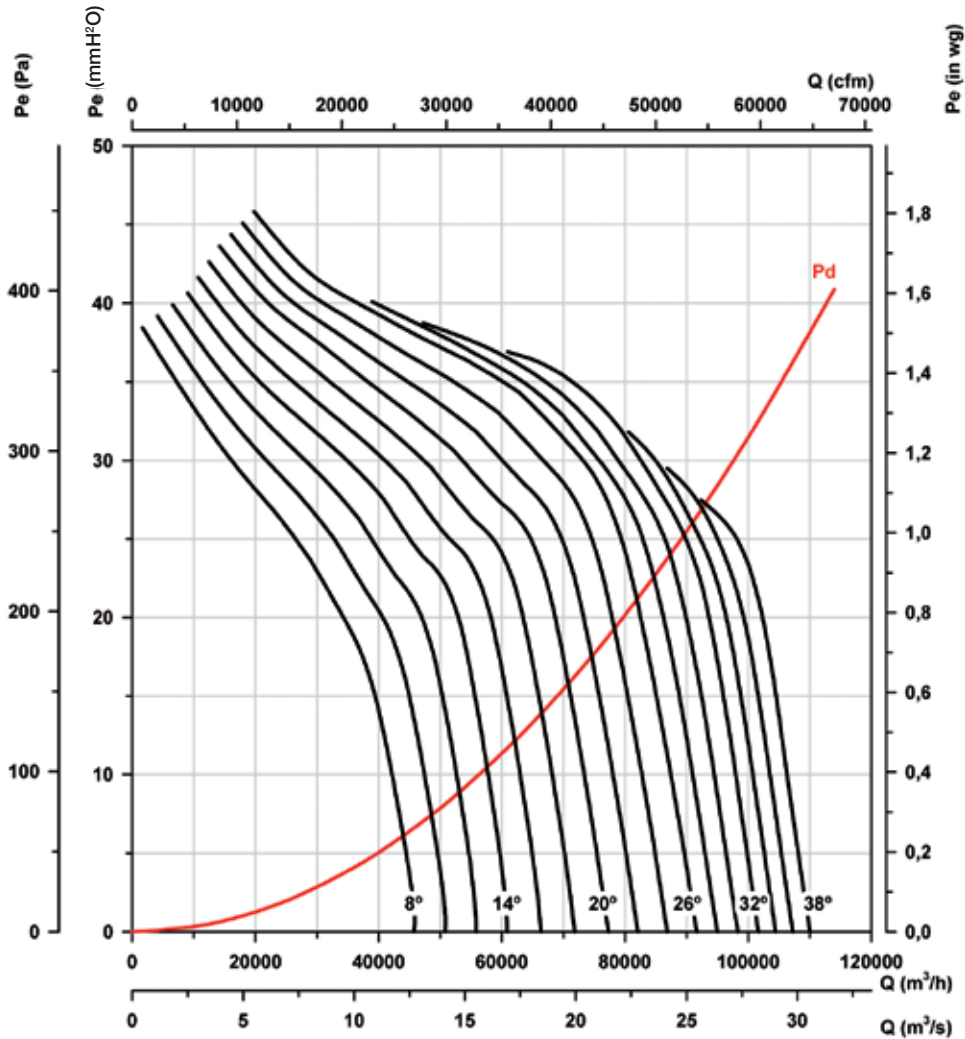

Potencia absorbida

Potencia Motor Recomendada kw(C.V.)

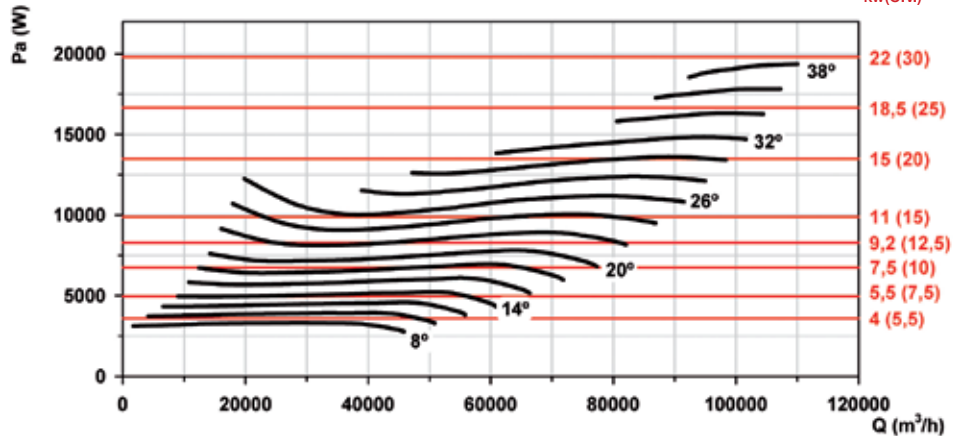

Curvas características

Q= Caudal en m³/h, m³/s y cfm.

Pe= Presión estática en mmH₂O, Pa e inwg.

Diámetro Hélice (cm): 125

Número de polos: 6

Número de palas: 6

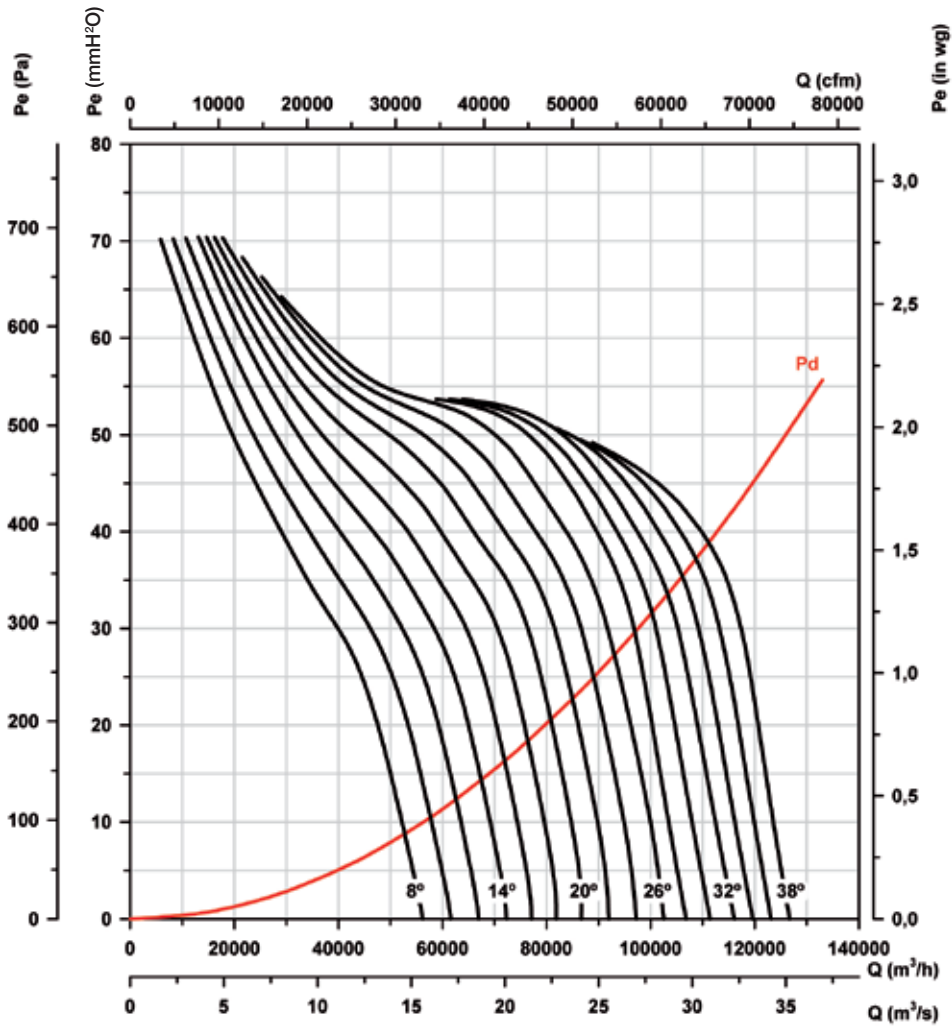

Potencia absorbida

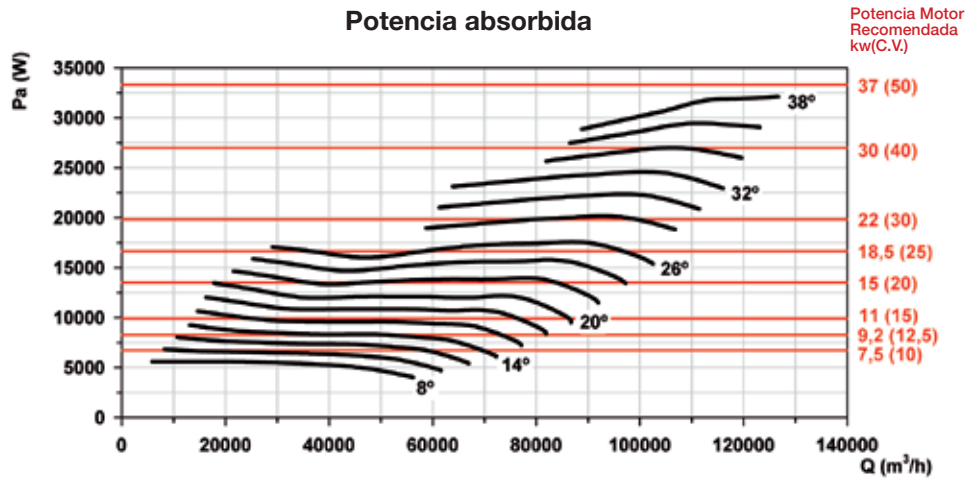

Curvas características

Q= Caudal en m³/h, m³/s y cfm.

Pe= Presión estática en mmH²O, Pa e inwg.

Diámetro Hélice (cm): 125

Número de polos: 6

Número de palas: 9

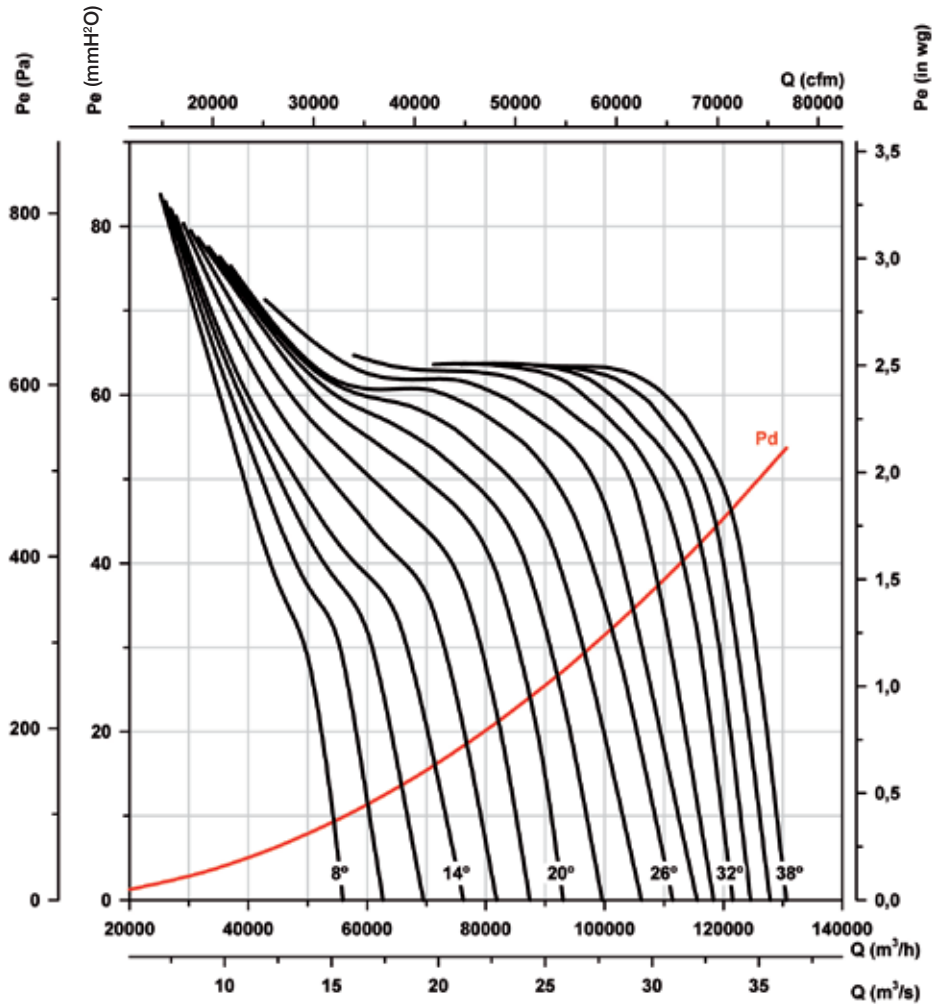

Potencia absorbida

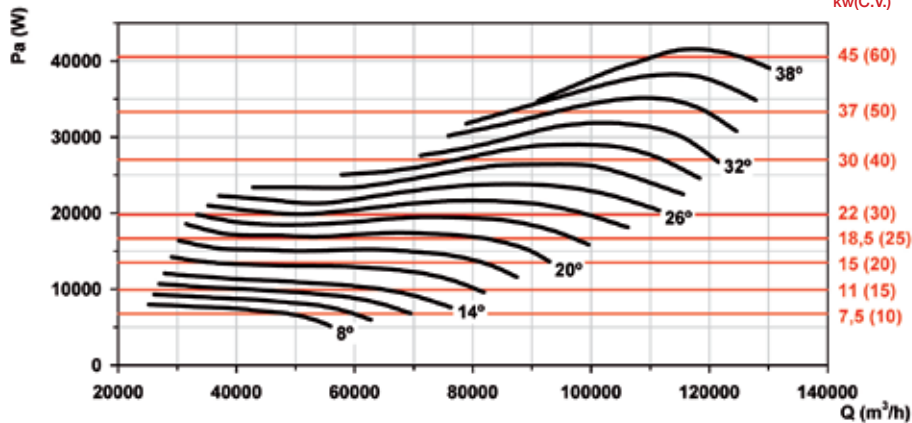

Curvas características

Q= Caudal en m³/h, m³/s y cfm. Pe= Presión estática en mmH₂O, Pa e inwg.

Diámetro Hélice (cm): 125

Número de polos: 8

Número de palas: 3

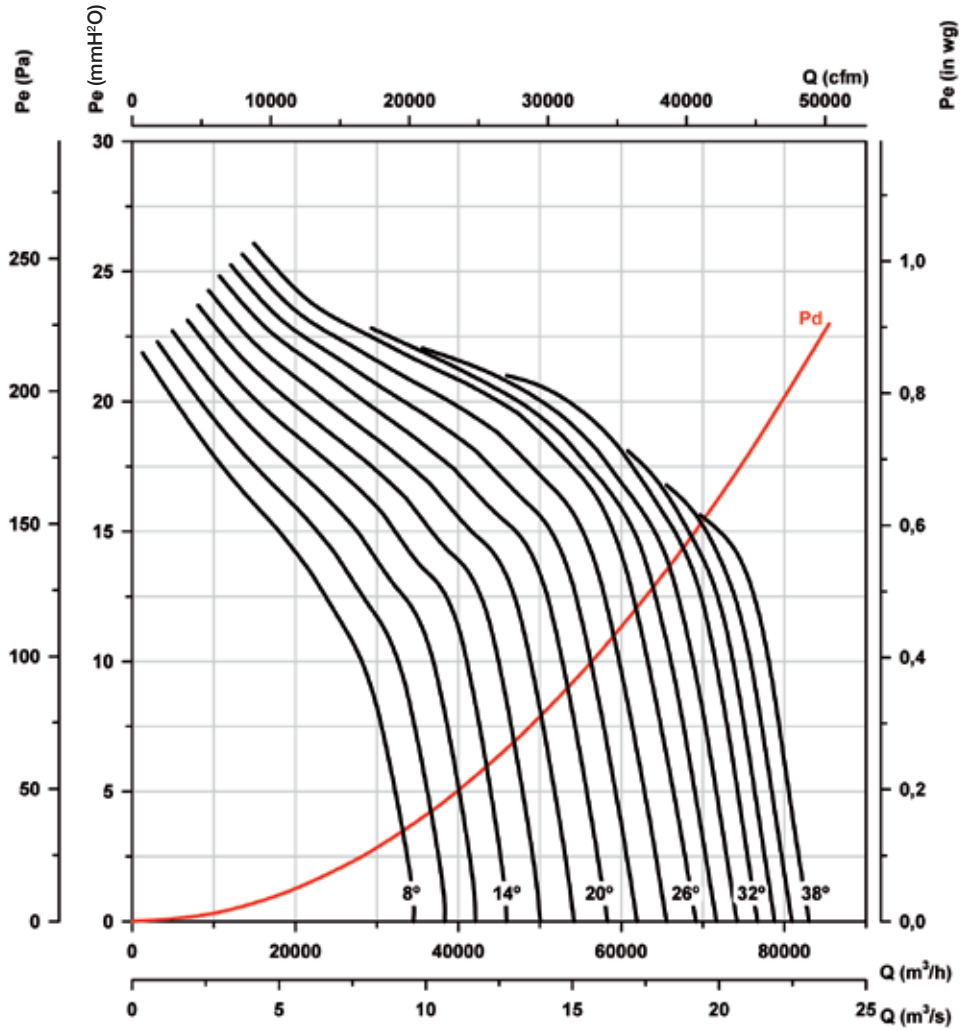

Potencia absorbida

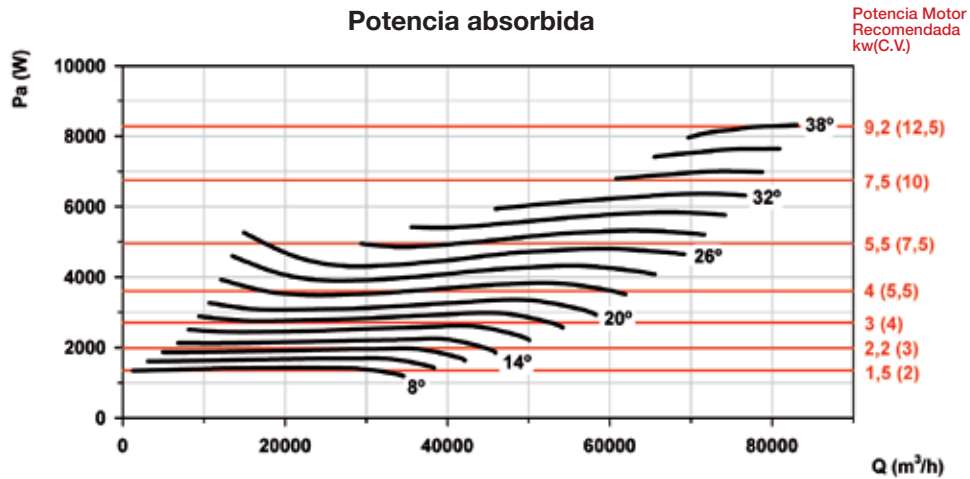

Curvas características

Q= Caudal en m³/h, m³/s y cfm.

Pe= Presión estática en mmH₂O, Pa e inwg.

Diámetro Hélice (cm): 125

Número de polos: 8

Número de palas: 6

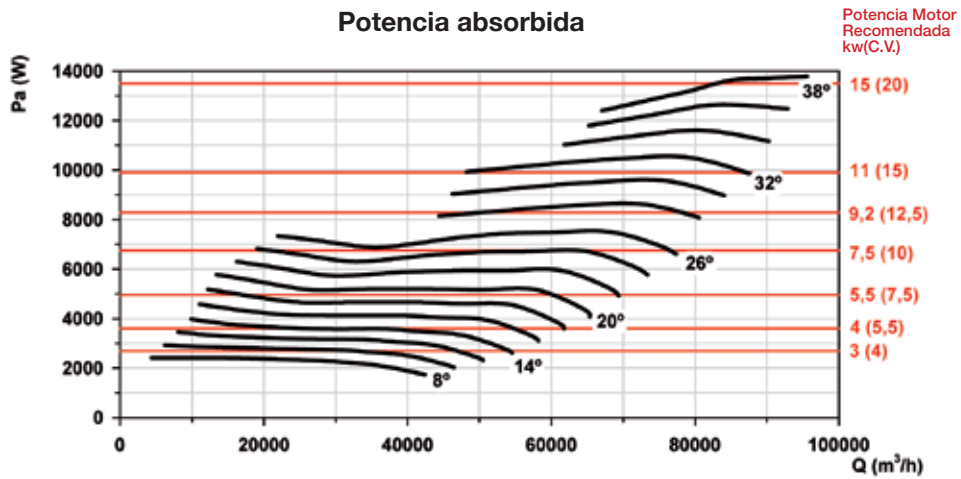
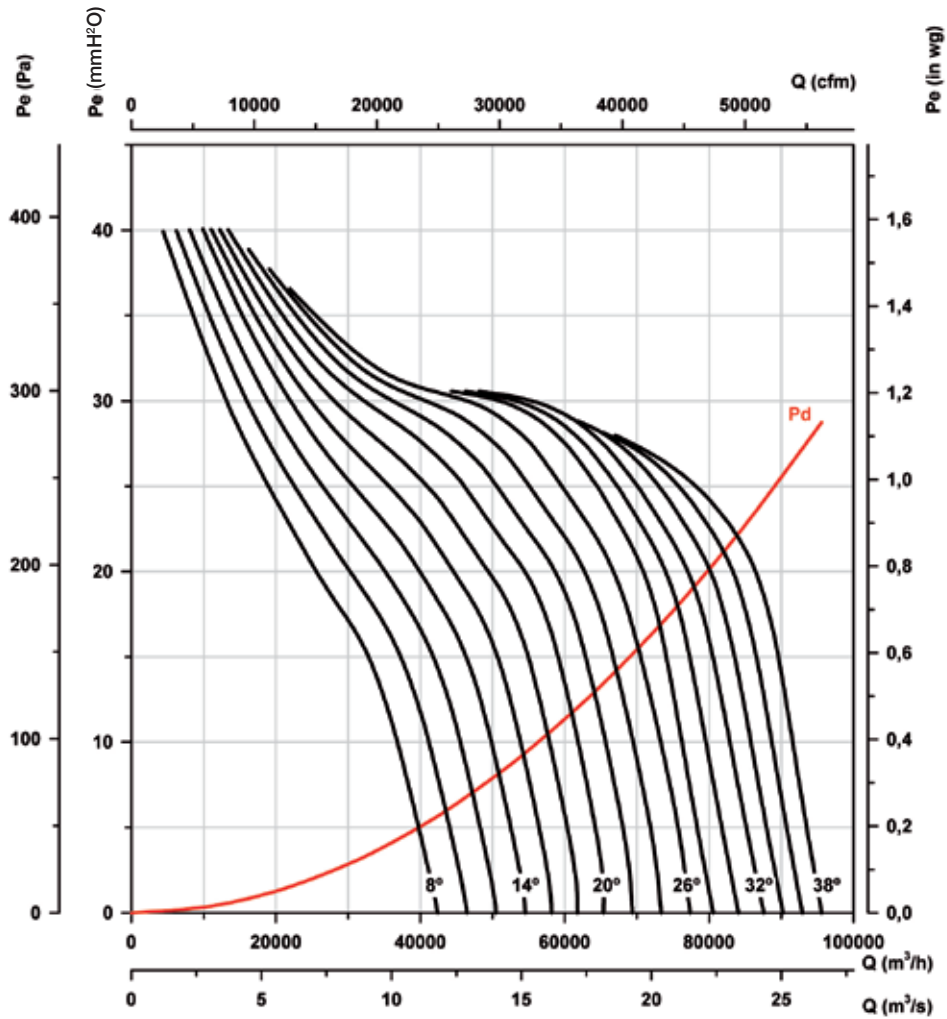

Curvas características

Q= Caudal en m³/h, m³/s y cfm.

Pe= Presión estática en mmH²O, Pa e inwg.

Diámetro Hélice (cm): 125

Número de polos: 8

Número de palas: 9

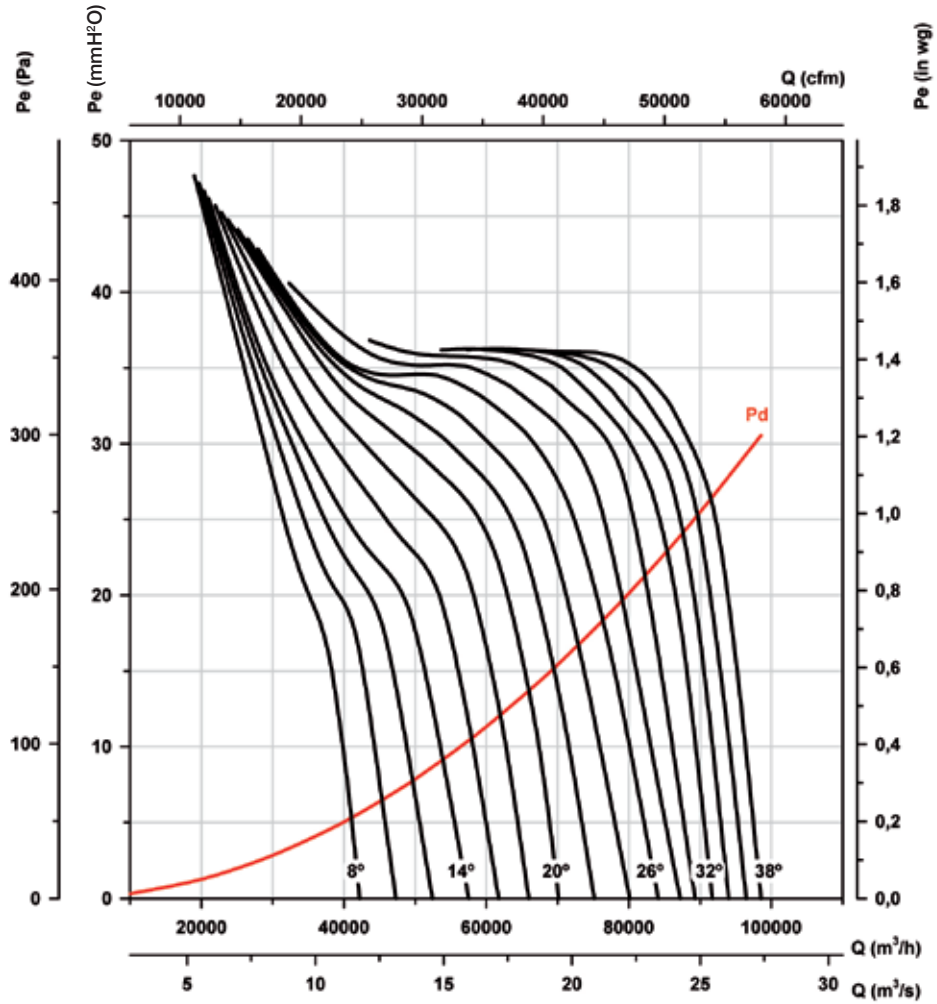

Potencia absorbida

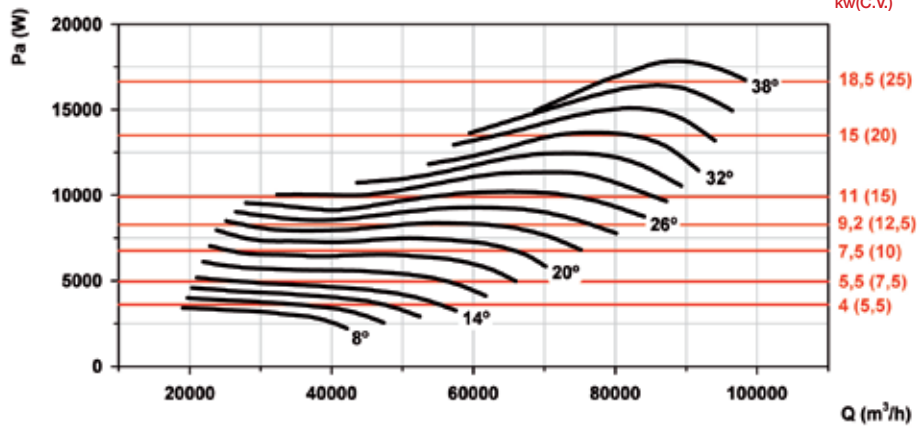

Potencia Motor Recomendada kw(C.V.)

Curvas características

Q= Caudal en m³/h, m³/s y cfm.

Pe= Presión estática en mmH₂O, Pa e inwg.

Diámetro Hélice (cm): 140

Número de polos: 6

Número de palas: 3

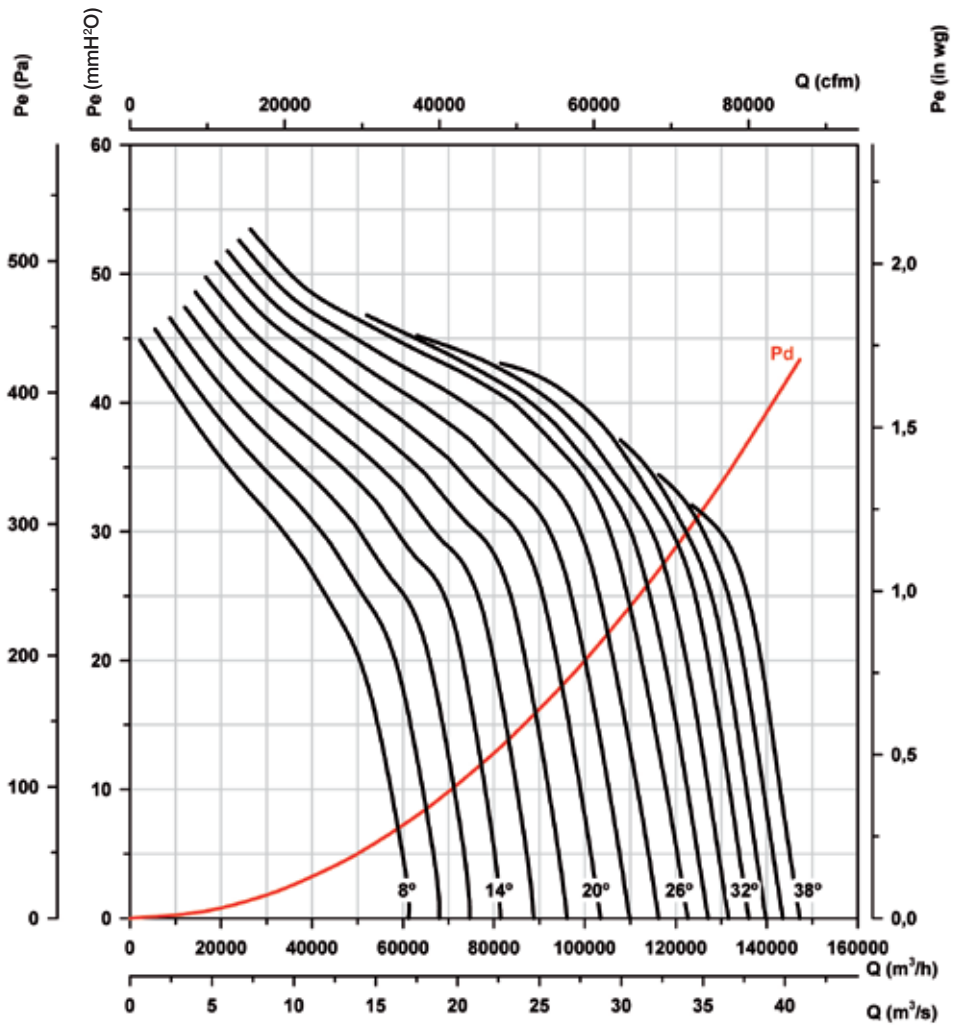

Potencia absorbida

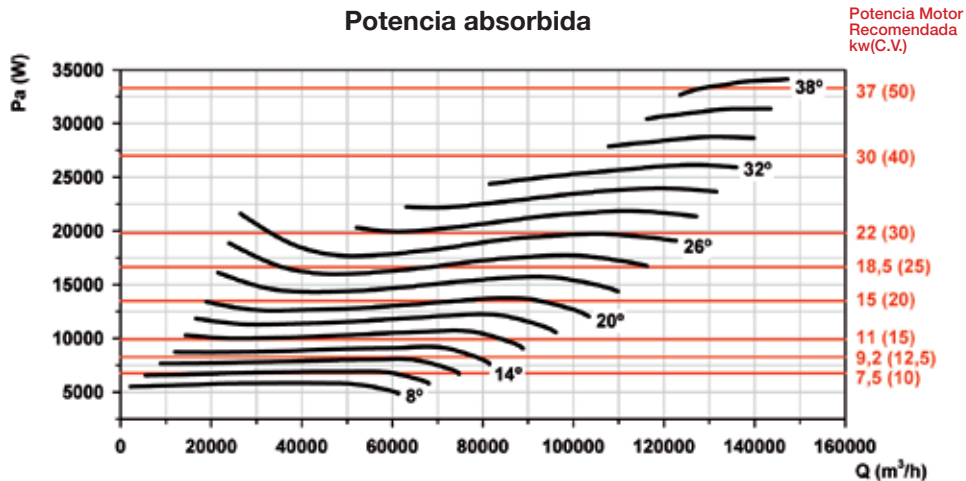

Curvas características

Q= Caudal en m³/h, m³/s y cfm.

Pe= Presión estática en mmH₂O, Pa e inwg.

Diámetro Hélice (cm): 140

Número de polos: 6

Número de palas: 6

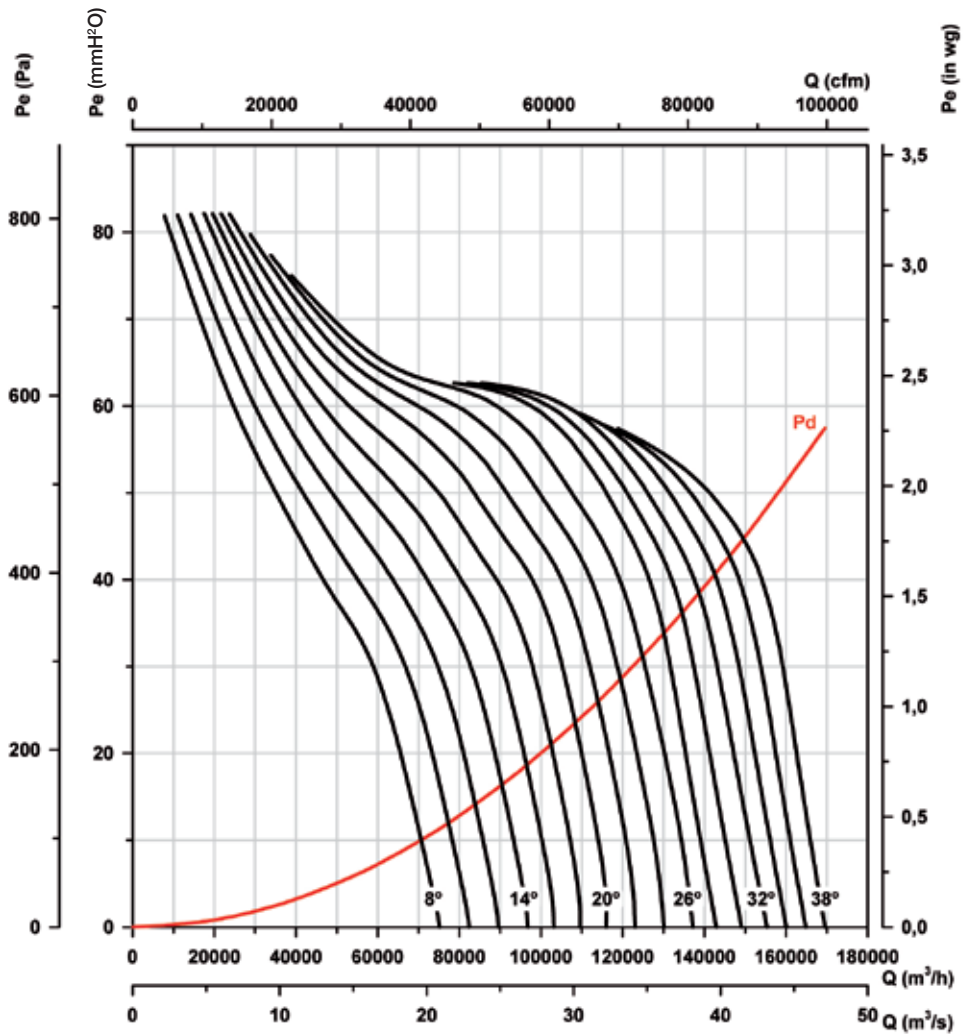

Potencia absorbida

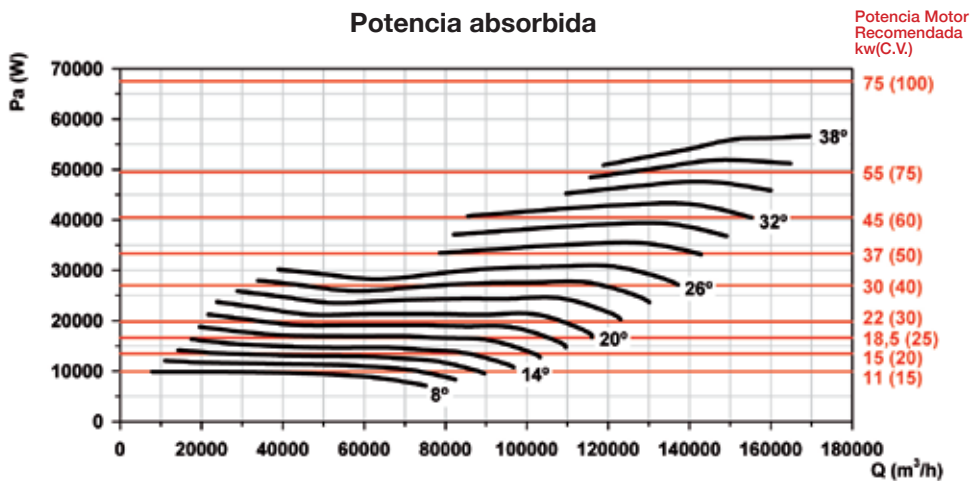

Curvas características

Q= Caudal en m³/h, m³/s y cfm.

Pe= Presión estática en mmH₂O, Pa e inwg.

Diámetro Hélice (cm): 140

Número de polos: 6

Número de palas: 9

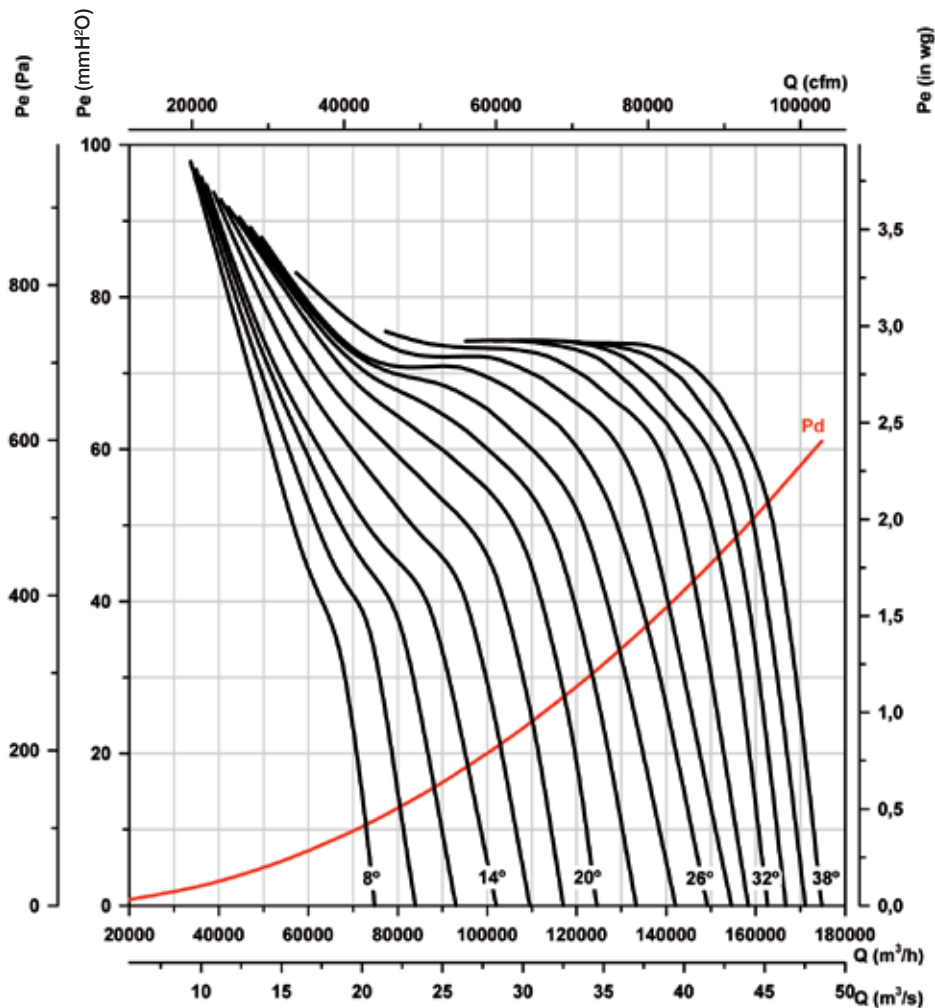

Potencia absorbida

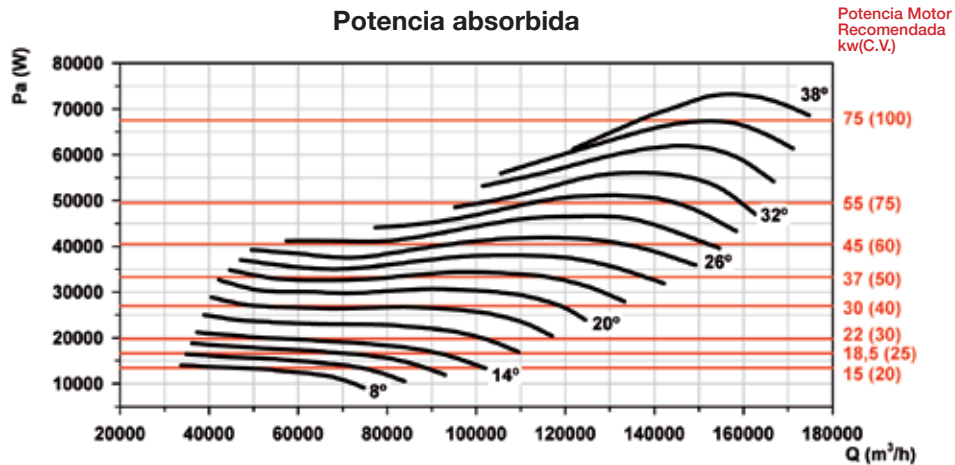

Curvas características

Q= Caudal en m³/h, m³/s y cfm.

Pe= Presión estática en mmH₂O, Pa e inwg.

Diámetro Hélice (cm): 140

Número de polos: 8

Número de palas: 3

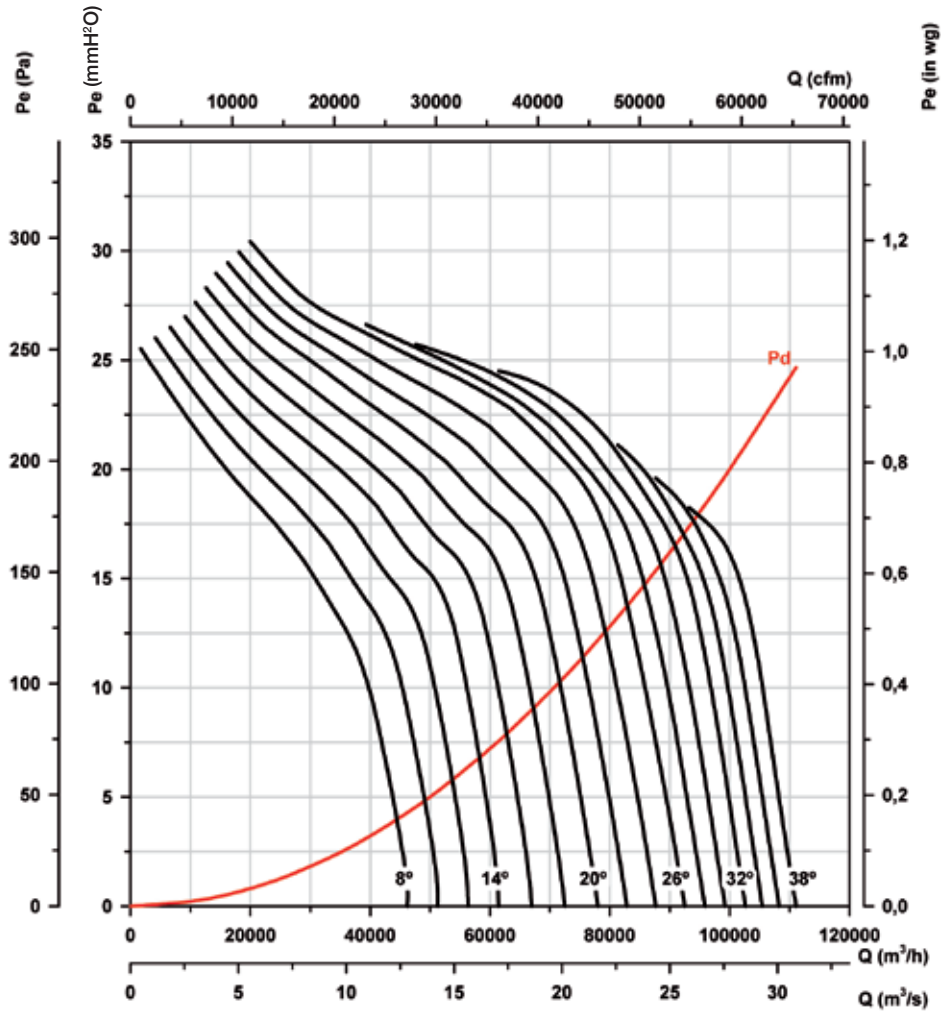

Potencia absorbida

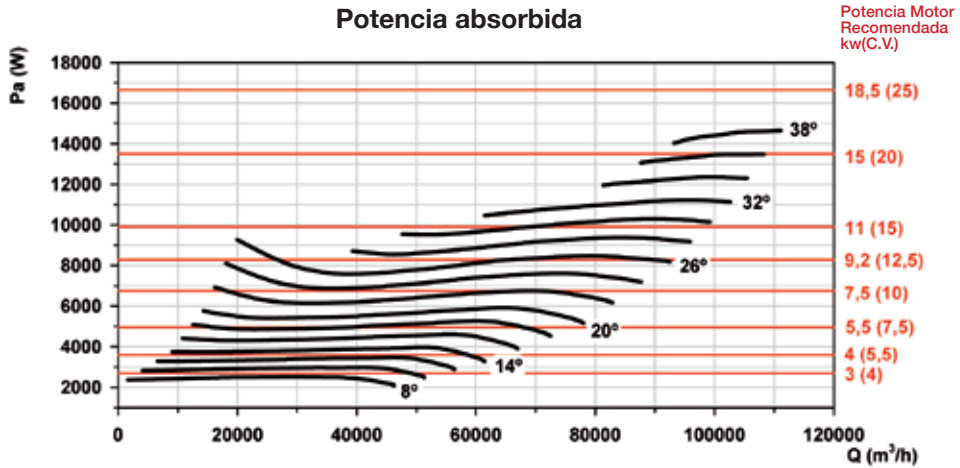

Curvas características

Q= Caudal en m³/h, m³/s y cfm.

Pe= Presión estática en mmH₂O, Pa e inwg.

Diámetro Hélice (cm): 140

Número de polos: 8

Número de palas: 6

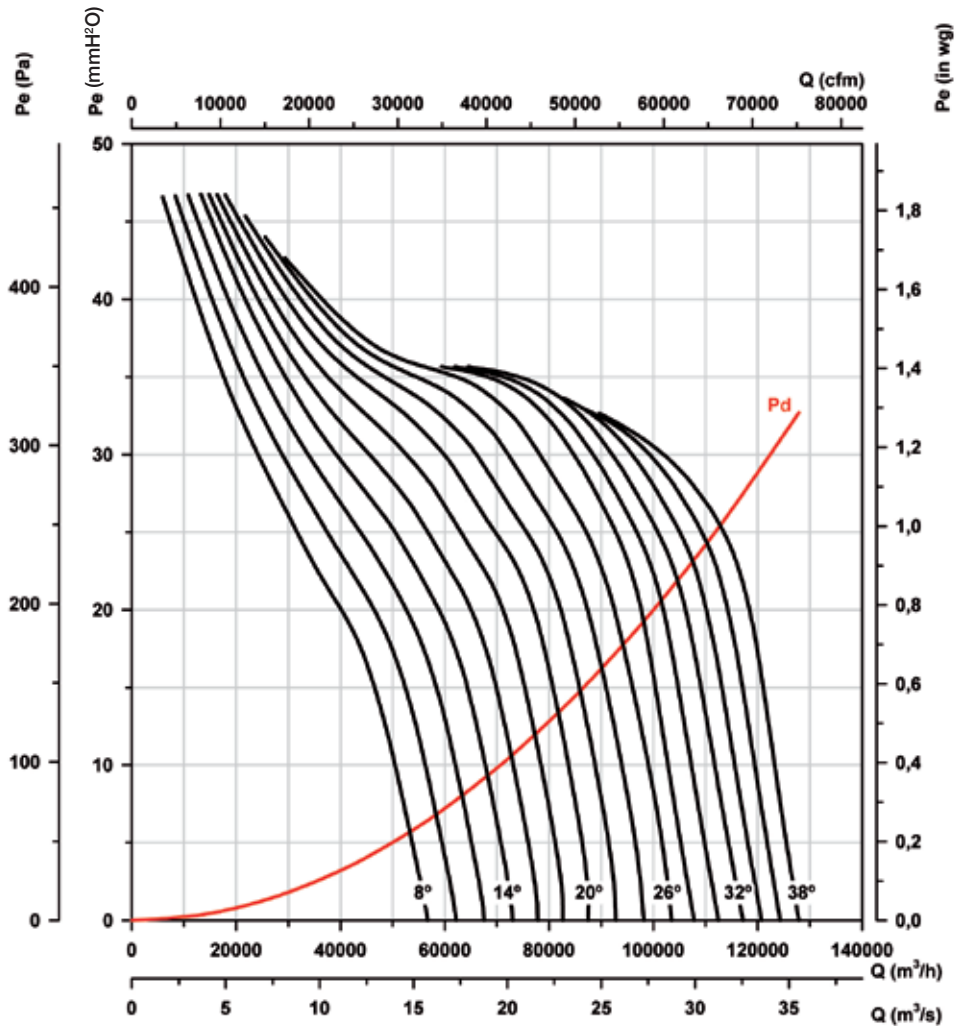

Potencia absorbida

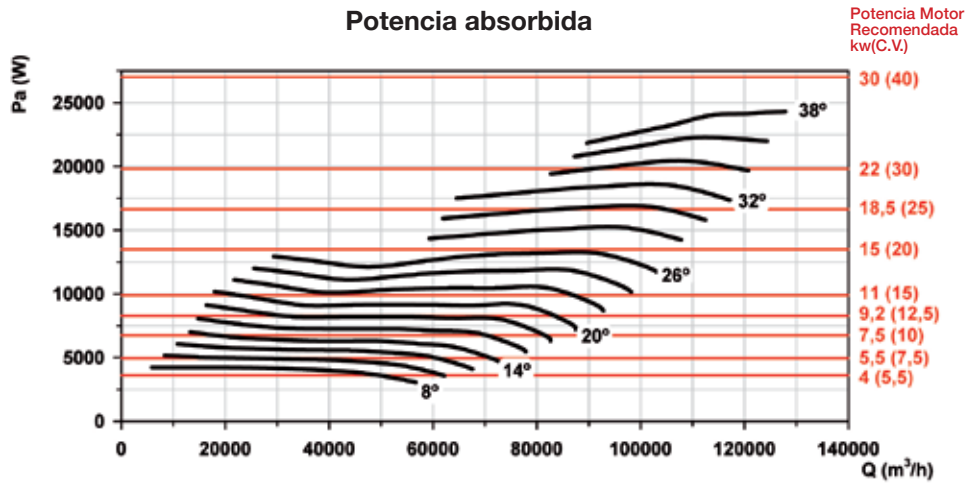

Curvas características

Q= Caudal en m³/h, m³/s y cfm.

Pe= Presión estática en mmH₂O, Pa e inwg.

Diámetro Hélice (cm): 140

Número de polos: 8

Número de palas: 9

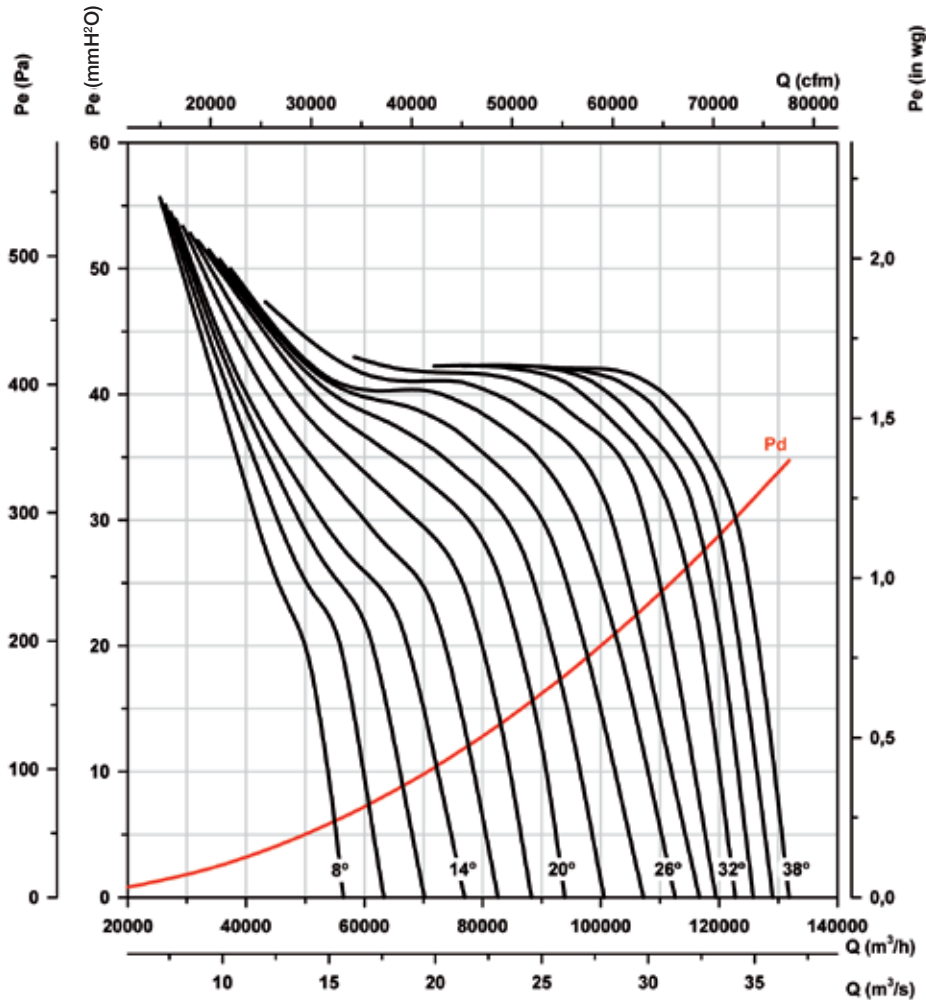

Potencia absorbida

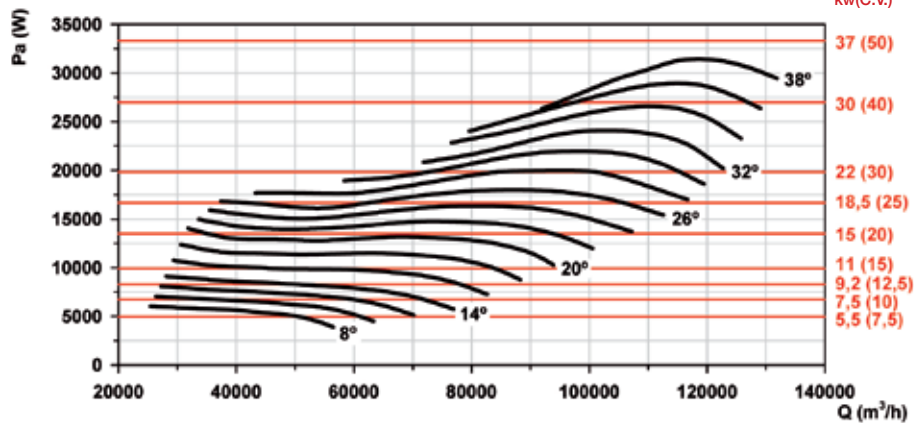

Potencia Motor Recomendada kw(C.V.)

Curvas características

Q= Caudal en m³/h, m³/s y cfm.

Pe= Presión estática en mmH₂O, Pa e inwg.

Diámetro Hélice (cm): 160

Número de polos: 6

Número de palas: 3

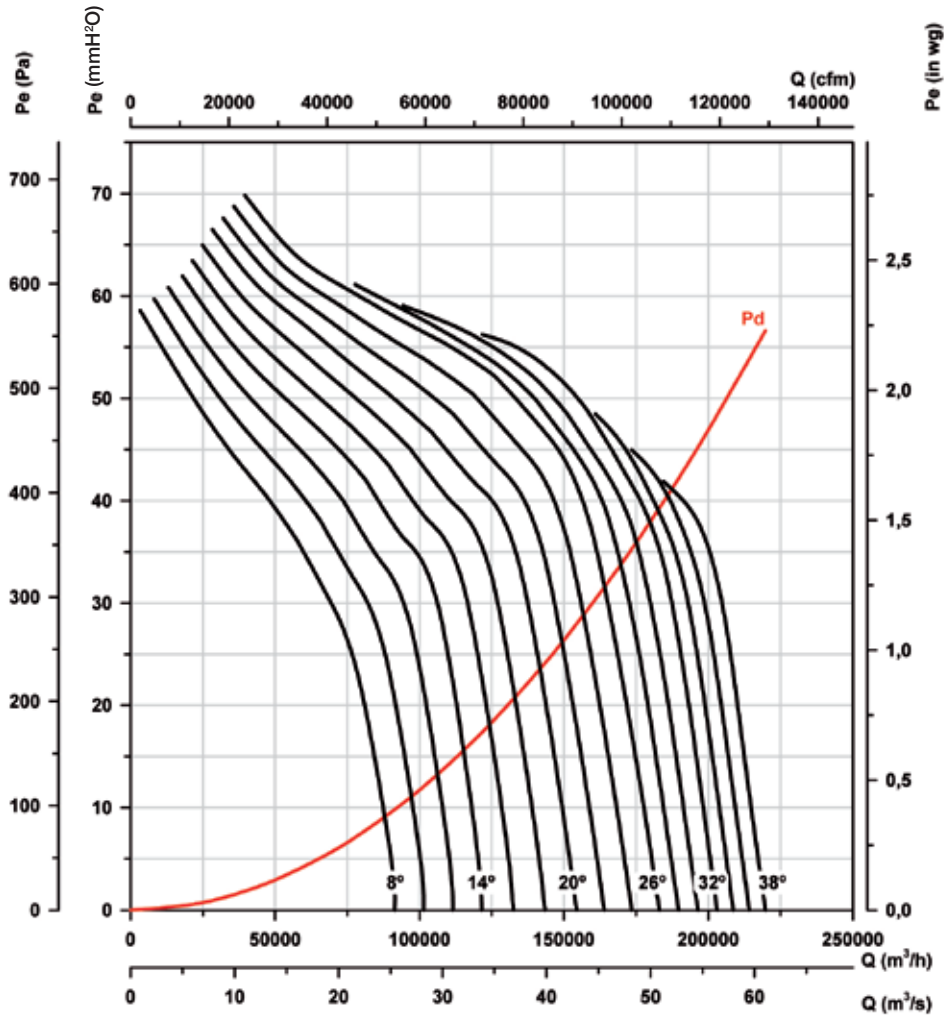

Potencia absorbida

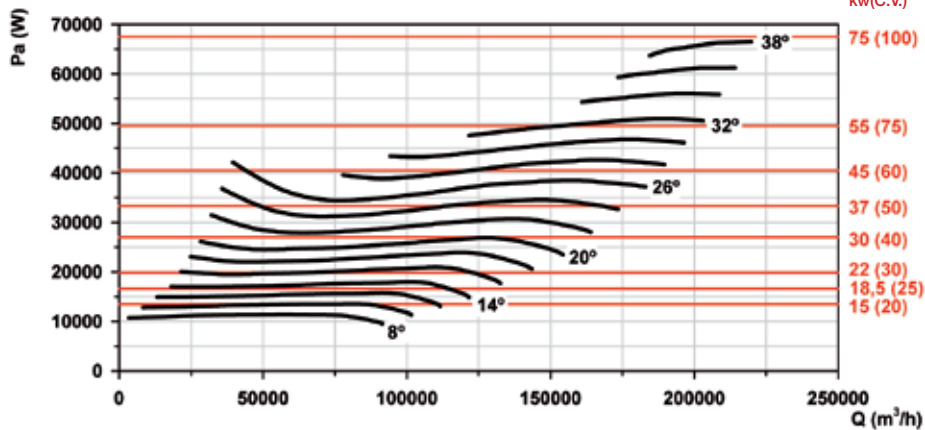

Curvas características

Q= Caudal en m³/h, m³/s y cfm.

Pe= Presión estática en mmH₂O, Pa e inwg.

Diámetro Hélice (cm): 160

Número de polos: 6

Número de palas: 8

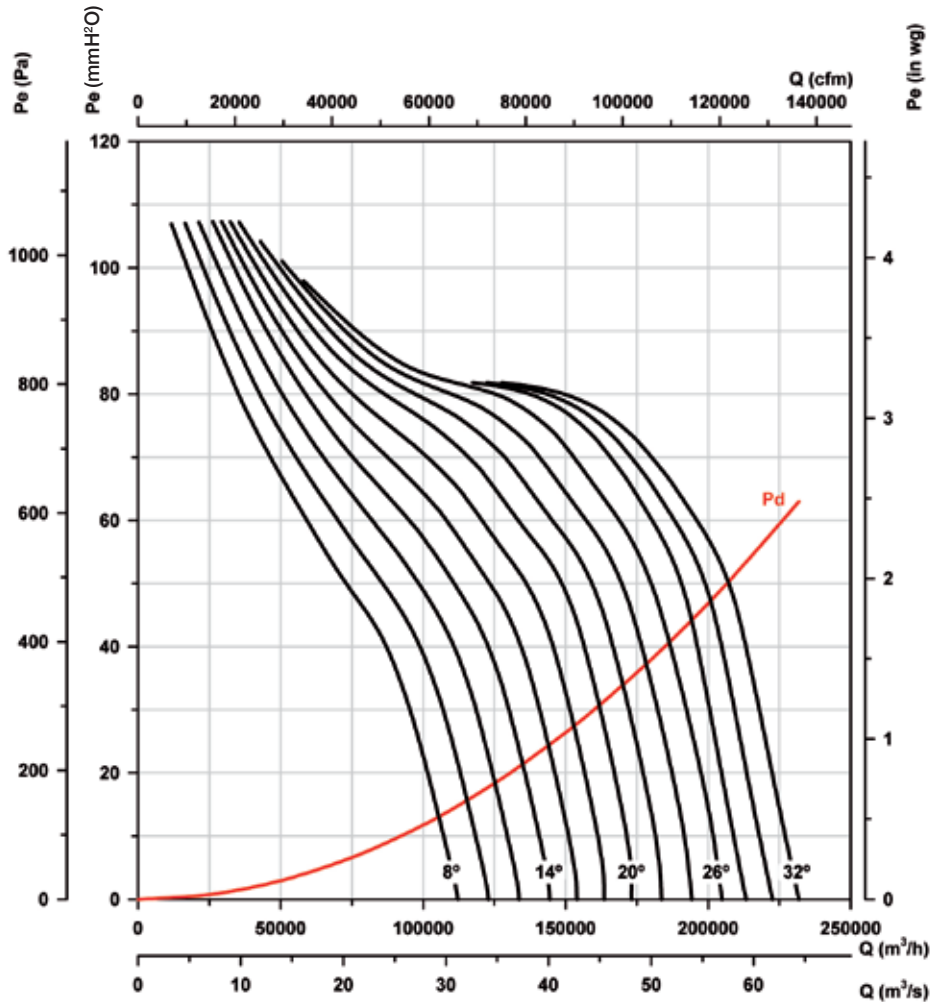

Potencia absorbida

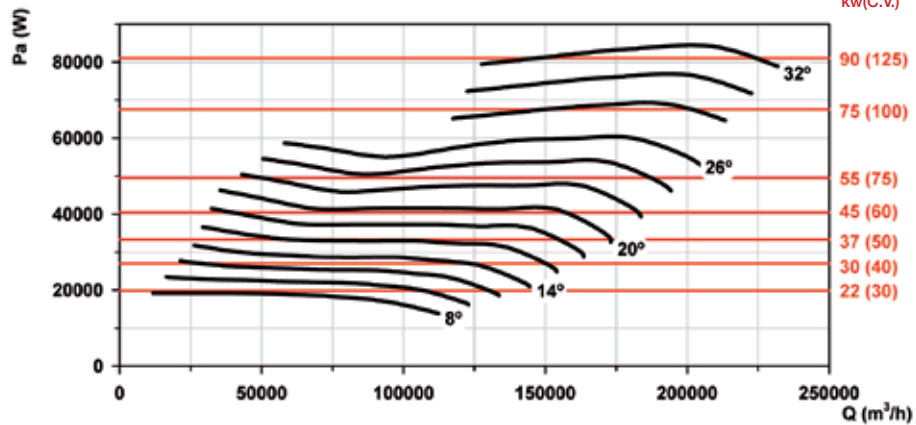

Potencia Motor Recomendada kw(C.V.)

Curvas características

Q= Caudal en m³/h, m³/s y cfm.

Pe= Presión estática en mmH₂O, Pa e inwg.

Diámetro Hélice (cm): 160

Número de polos: 6

Número de palas: 9

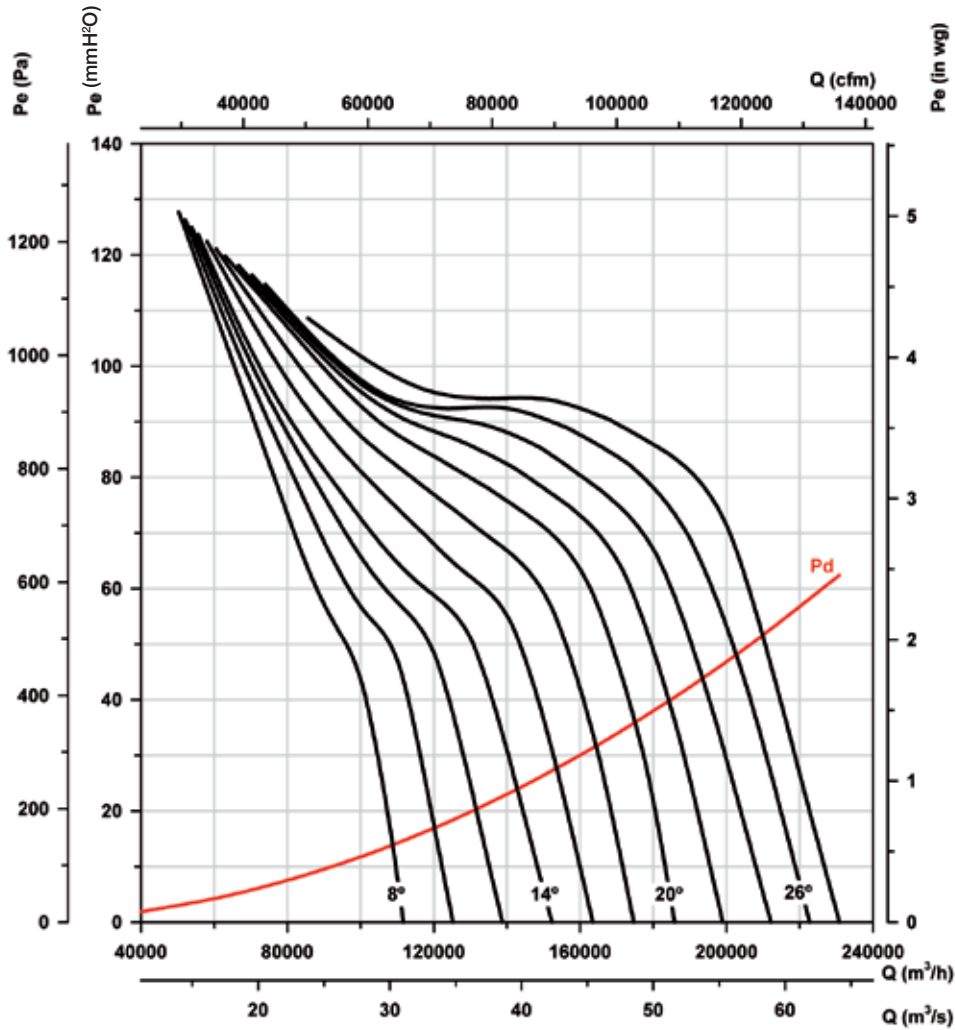

Potencia absorbida

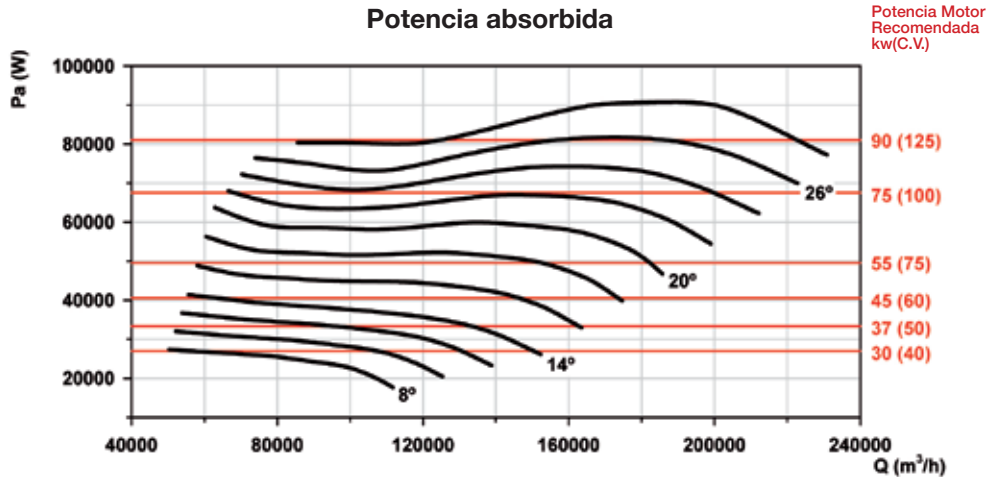

Curvas características

Q= Caudal en m³/h, m³/s y cfm.

Pe= Presión estática en mmH₂O, Pa e inwg.

Diámetro Hélice (cm): 160

Número de polos: 8

Número de palas: 3

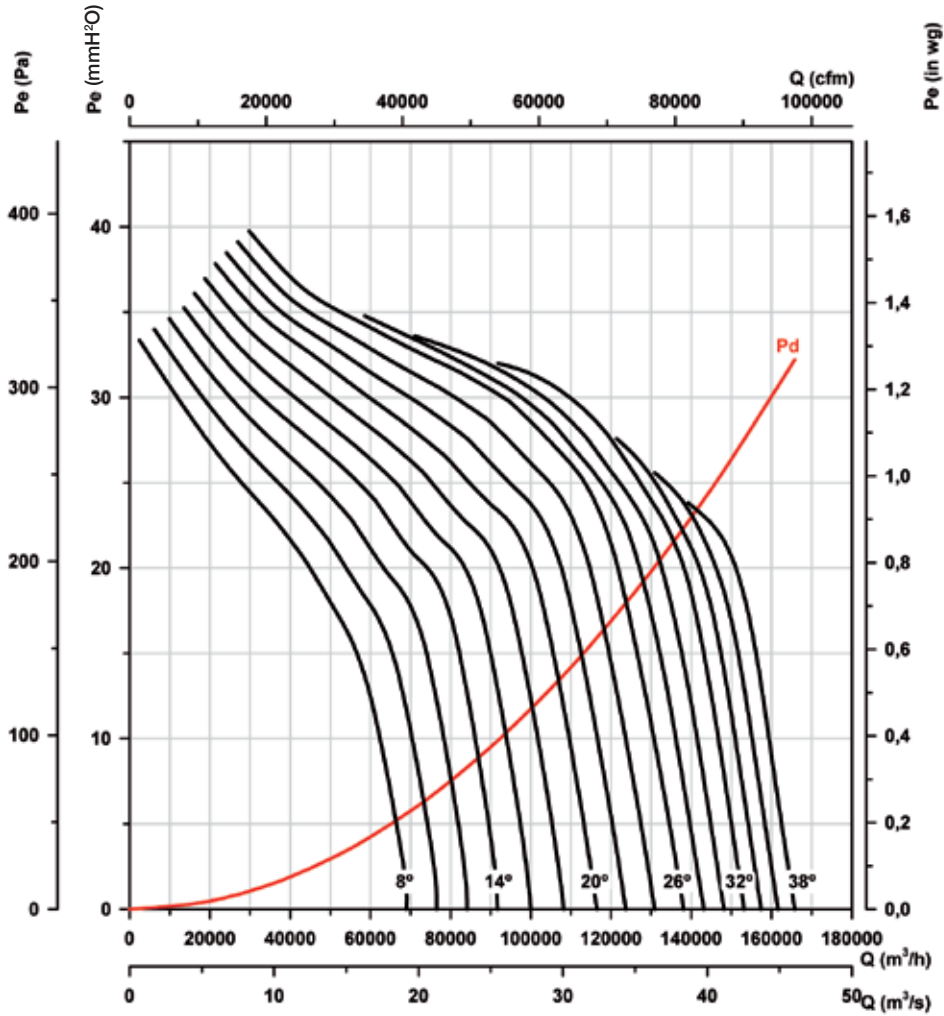

Potencia absorbida

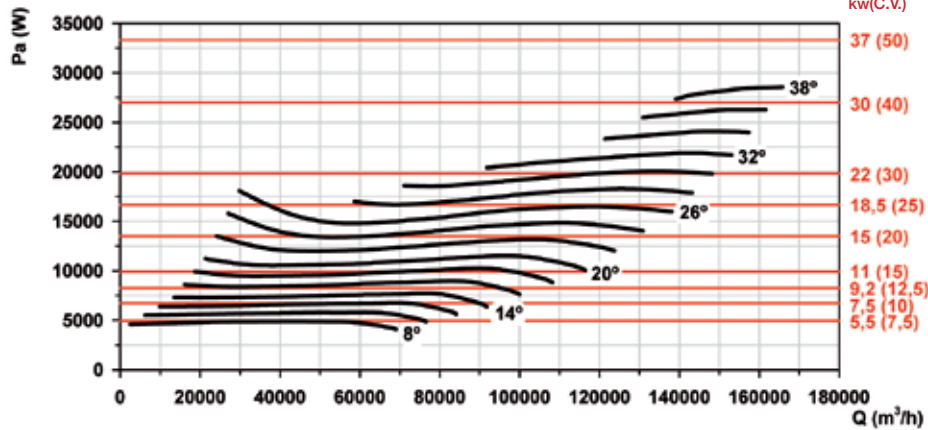

Curvas características

Q= Caudal en m³/h, m³/s y cfm.

Pe= Presión estática en mmH₂O, Pa e inwg.

Diámetro Hélice (cm): 160

Número de polos: 8

Número de palas: 6

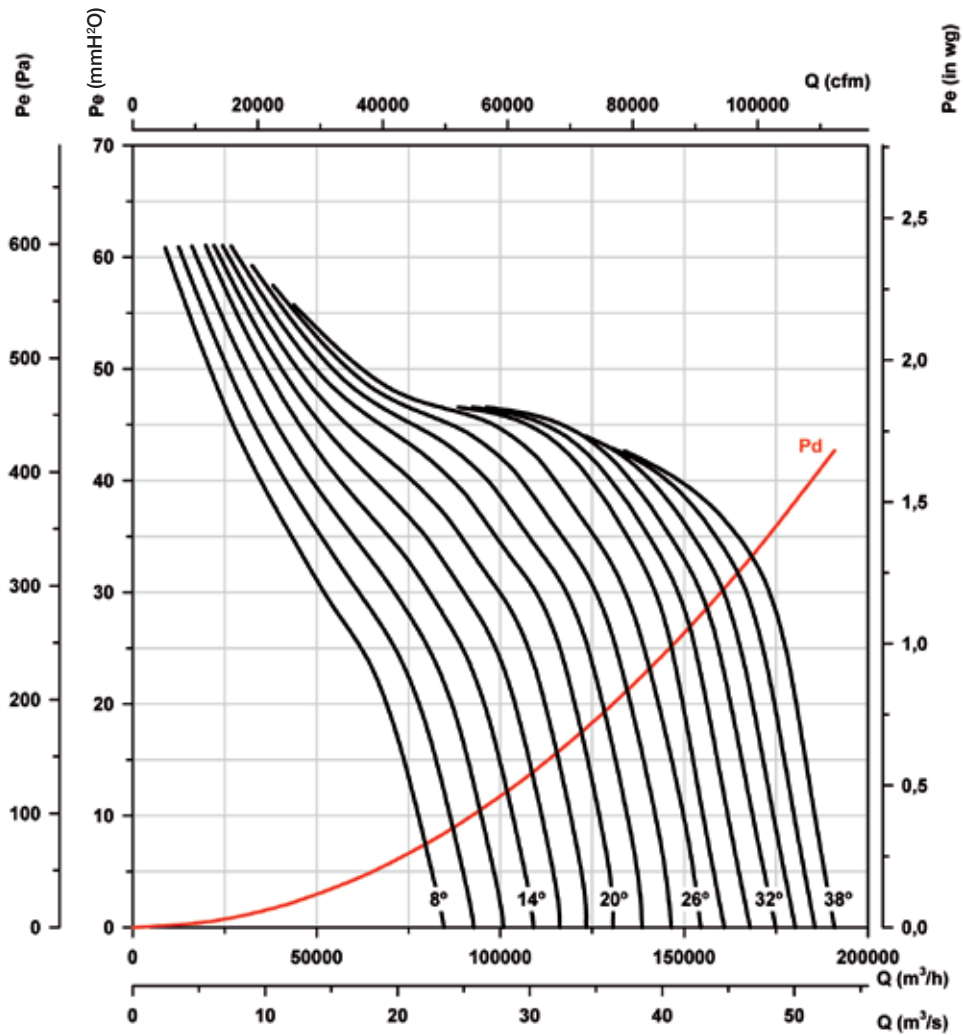

Potencia absorbida

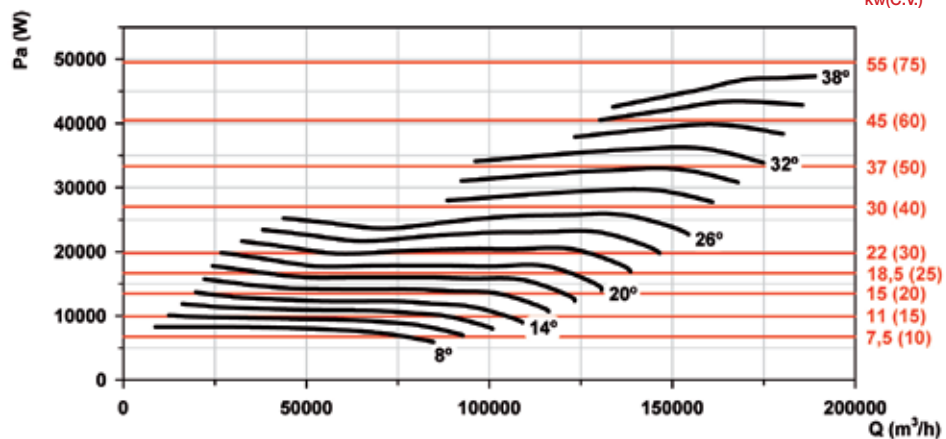

Potencia Motor Recomendada kw(C.V.)

Curvas características

Q= Caudal en m³/h, m³/s y cfm. Pe= Presión estática en mmH₂O, Pa e inwg.

Diámetro Hélice (cm): 160

Número de polos: 8

Número de palas: 9

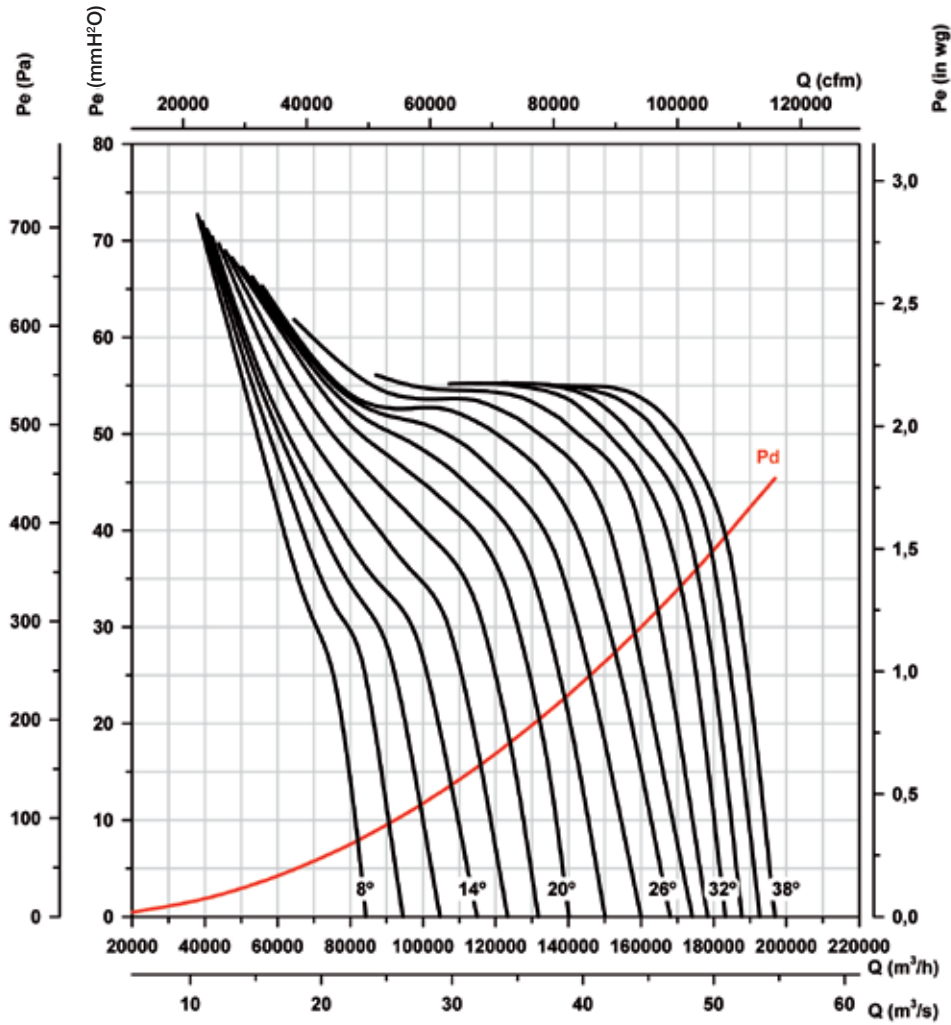

Potencia absorbida

Potencia Motor Recomendada kw(C.V.)

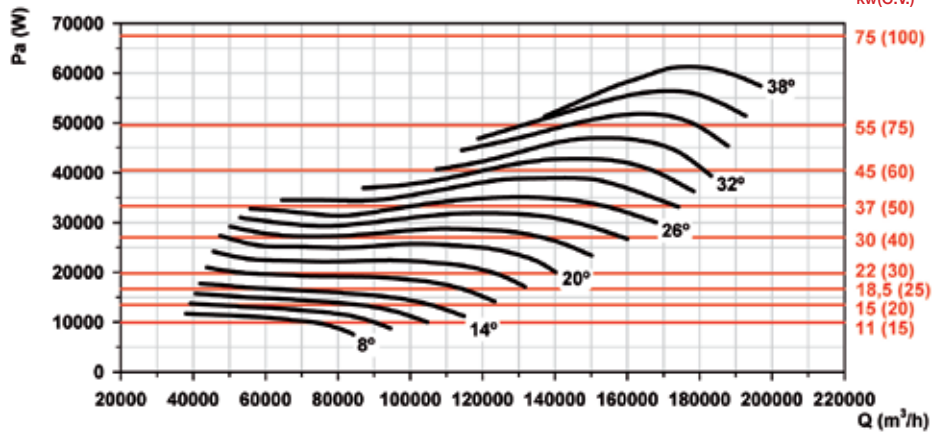

HPX

Ventiladores helicoidales tubulares, con motor exterior



Ventiladores helicoidales tubulares, accionados a transmisión, con apertura de envolvente hasta 180°.

Ventilador:

- Envolvente tubular con tapa giratoria, en chapa de acero
- Hélices en fundición de aluminio
- Grupo de transmisión estanco (IP66) con sistema de doble retén
- Dirección aire motor-hélice
- Temperatura del aire a transportar: -25°C +120°C

Motor:

- Motores de eficiencia IE3 para potencias iguales o superiores a 0,75kW, excepto monofásicos, 2 velocidades y 8 polos.
- Motores clase F, con rodamientos a bolas, protección IP55
- Motor Multitensión, diseño especial válido para: 220/380V 60Hz, 254/440V 60Hz, 265/460V 60Hz, 277/480V 60Hz

Acabado:

- Anticorrosivo en resina de poliéster polimerizada a 190 °C, previo desengrase con tratamiento nanotecnológico libre de fosfatos.

Bajo demanda:

- Dirección aire hélice-motor
- Hélices reversibles 100%
- Bobinados especiales para diferentes tensiones
- Certificación ATEX Categoría 2 (ver serie HPX/ATEX)

Código de pedido

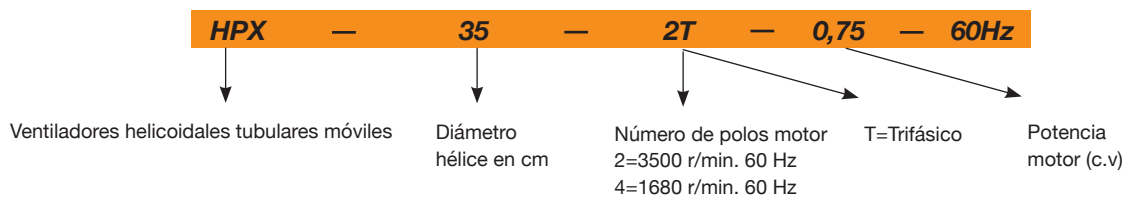

60Hz

Características técnicas

Modelo	Velocidad (r/min)	Intensidad máx admisible (A)		Potencia instalada (kW)	Caudal máximo (m³/h)	Nivel presión sonora dB(A)	Peso aprox. (Kg)
		220-277V	380-480V				
HPX-35-2T-0,75	2720	2,36	1,36	0,55	4750	77	22
HPX-35-4T-0,33	1420	1,58	0,91	0,25	2500	60	20
HPX-45-4T-0,33	1200	1,58	0,91	0,25	6300	69	32
HPX-45-4T-0,50	1420	1,94	1,12	0,37	6600	70	35,5
HPX-50-4T-0,75	1310	2,51	1,45	0,55	9000	70	32,5
HPX-50-4T-1	1500	3,22	1,86	0,75	10800	71	34
HPX-56-4T-0,75	1380	2,51	1,45	0,55	11300	72	35,5
HPX-56-4T-1	1420	3,22	1,86	0,75	12200	73	35,5
HPX-56-4T-1,5	1420	4,59	2,65	1,10	14500	75	39
HPX-63-4T-1,5	1300	4,59	2,65	1,10	16000	74	59
HPX-63-4T-2	1420	5,98	3,45	1,50	17500	78	63
HPX-71-4T-1,5	1200	4,59	2,65	1,10	20300	78	73,5
HPX-71-4T-2	1350	5,98	3,45	1,50	22500	79	76,8
HPX-71-4T-3	1450	8,49	4,90	2,20	24000	81	85,2
HPX-80-4T-3	1200	8,49	4,90	2,20	29000	83	95
HPX-80-4T-4	1350	11,26	6,50	3,00	32000	84	100
HPX-80-4T-5,5	1450	14,38	8,30	4,00	40500	84	106
HPX-90-4T-5,5	1280	14,38	8,30	4,00	44000	89	118
HPX-90-4T-7,5	1400		11,40	5,50	51000	91	132
HPX-100-4T-10	1450		15,10	7,5	63000	93	159
HPX-100-4 T-15	1450		21,40	11,0	68000	94	181

Características acústicas

Los valores indicados, se determinan mediante medidas de nivel de presión y potencia sonora en dB(A) obtenidas en campo libre a una distancia equivalente a dos veces la envergadura del ventilador más el diámetro de la hélice, con un mínimo de 1,5 mts.

Espectro de potencia sonora Lw(A) en dB(A) banda de frecuencia en [Hz]

Modelo	63	125	250	500	1000	2000	4000	8000	Modelo	63	125	250	500	1000	2000	4000	8000
35-2-0,75	48	63	82	81	82	81	76	67	71-4-1,5	55	75	83	88	90	87	80	69
35-4-0,33	31	46	65	64	65	64	59	50	74-4-2	56	76	84	89	91	88	81	70
45-4-0,33	40	55	74	73	74	73	68	59	71-4-3	65	76	86	92	93	88	77	73
45-4-0,50	41	56	75	74	75	74	69	60	80-4-3	60	80	88	93	95	92	85	74
50-4-0,75	44	58	77	77	78	76	72	63	80-4-4	61	81	89	94	96	93	86	75
50-4-1	45	59	78	78	79	77	73	64	80-4-5,5	68	79	89	95	96	91	80	76
56-4-0,75	47	67	75	80	82	79	72	61	90-4-5,5	67	88	95	100	103	99	92	81
56-4-1	48	68	76	81	83	80	73	62	90-4-7,5	69	90	97	102	105	101	94	83
56-4-1,5	57	68	78	84	85	80	69	65	100-4-10	73	93	101	106	108	105	98	87
63-4-1,5	51	71	79	84	86	83	76	65	100-4-15	74	94	102	107	109	106	99	88
63-4-2	62	73	83	89	90	85	74	70									

Dimensiones mm

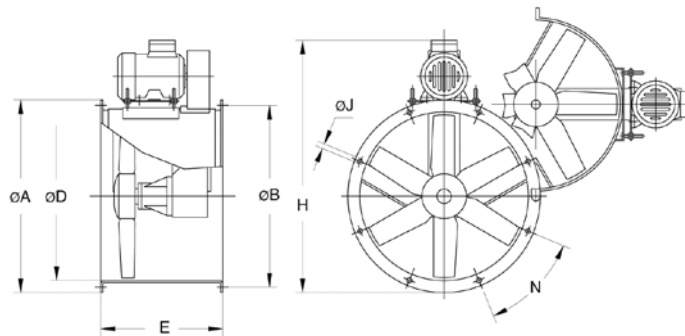

Modelo	ØA	ØB	ØD	E	H	ØJ	N	Modelo	ØA	ØB	ØD	E	H	ØJ	N
HPX-35-2T-0,75	425	395	355	380	606	10	8x45°	HPX-71-4T-1,5	810	770	710	550	1017	12	16x22°30'
HPX-35-4T-0,33	425	395	355	380	609	10	8x45°	HPX-71-4T-2	810	770	710	550	1017	12	16x22°30'
HPX-45-4T-0,33	540	500	460	420	740	12	8x45°	HPX-71-4T-3	810	770	710	550	1035	12	16x22°30'
HPX-45-4T-0,50	540	500	460	420	728	12	8x45°	HPX-80-4T-3	900	860	800	600	1173	12	16x22°30'
HPX-50-4T-0,75	600	560	512	420	803	12	12x30°	HPX-80-4T-4	900	860	800	600	1173	12	16x22°30'
HPX-50-4T-1	600	560	512	420	803	12	12x30°	HPX-80-4T-5,5	900	860	800	600	1200	12	16x22°30'
HPX-56-4T-0,75	660	620	560	450	848	12	12x30°	HPX-90-4T-5,5	1015	970	900	650	1320	15	16x22°30'
HPX-56-4T-1	660	620	560	450	848	12	12x30°	HPX-90-4T-7,5	1015	970	900	650	1320	15	16x22°30'
HPX-56-4T-1,5	660	620	560	450	870	12	12x30°	HPX-100-4T-10	1115	1070	1000	750	1483	15	16x22°30'
HPX-63-4T-1,5	730	690	640	500	950	12	12x30°	HPX-100-4T-15	1115	1070	1000	750	1513	15	16x22°30'
HPX-63-4T-2	730	690	640	500	950	12	12x30°								

Curvas características

Q= Caudal en m³/h, m³/s y cfm. Pe= Presión estática en mmH²O, Pa e inwg.

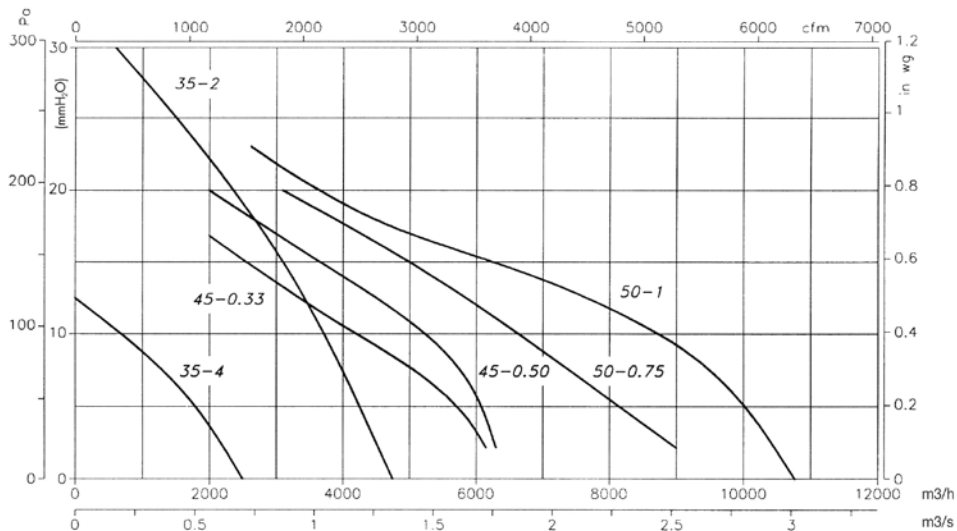

Curvas características

Q= Caudal en m³/h, m³/s y cfm.

Pe= Presión estática en mmH₂O, Pa e inwg.

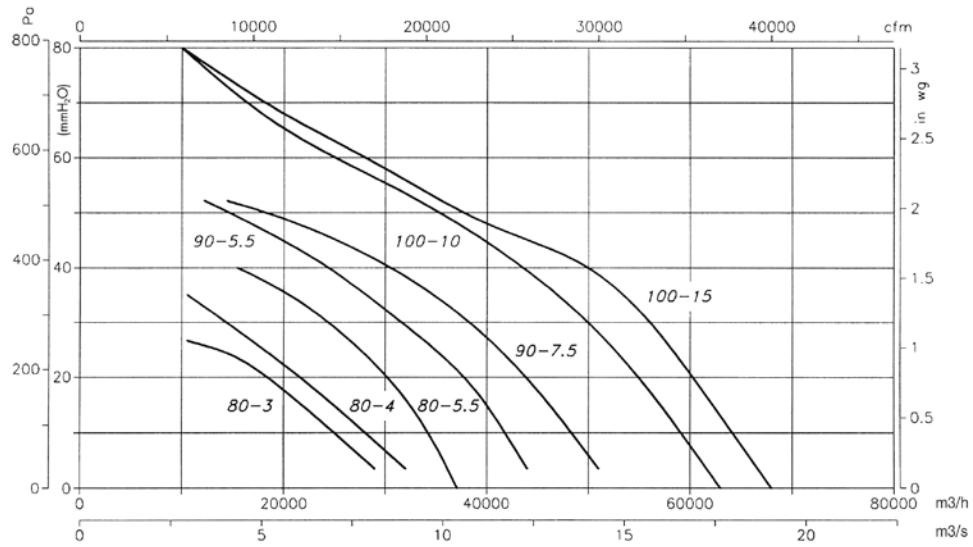
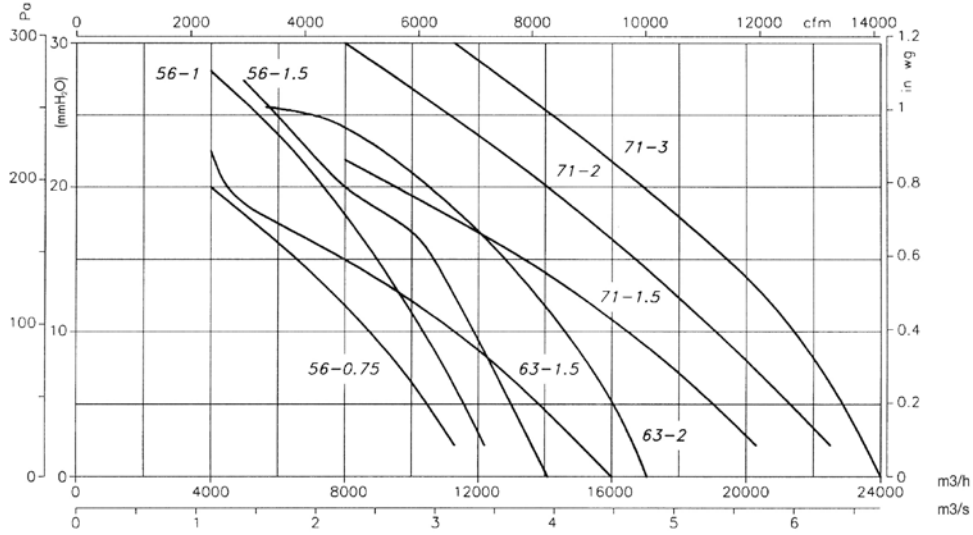

Accesorios



INT

VSD3/A-RFT
VSD1/A-RFM

CUADROS

RT

BTUB

BAC

PS

S

SI

HBA

Ventiladores helicoidales tubulares bifurcados, con motor fuera del flujo de aire

Ventiladores tubulares bifurcados para trasegar aire hasta 150°C en continuo y hasta 200°C de forma esporádica.



Ventilador:

- Envoltente tubular en chapa de acero
- Hélice en fundición de aluminio
- Dirección de aire hélice-motor

Motor:

- Motores de eficiencia IE3 para potencias iguales o superiores a 0,75kW, excepto monofásicos, 2 velocidades y 8 polos.
- Motores clase F, con rodamientos a bolas, protección IP-55
- Motor Multitensión, diseño especial válido para: 220/380V 60Hz, 254/440V 60Hz, 265/460V 60Hz, 277/480V 60Hz
- Temperatura de trabajo: -25°C. + 150°C

Acabado:

- Anticorrosivo en resina de poliéster polimerizada a 190 °C, previo desengrase con tratamiento nanotecnológico libre de fosfatos.

Bajo demanda:

- Envoltente en acero inoxidable
- Acabado en galvanizado en caliente
- Bobinados especiales para diferentes tensiones y motores con PTC

Código de pedido

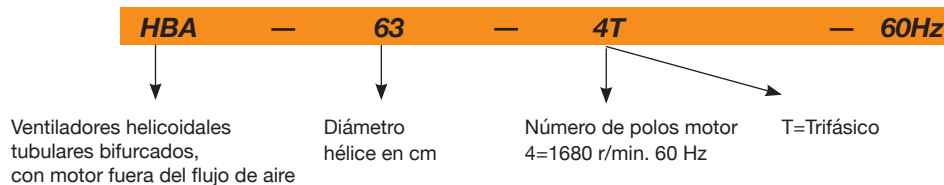

60Hz

Características técnicas

Modelo	Velocidad (r/min)	Intensidad máxima admisible (A)		Potencia instalada (kW)	Caudal máximo (m³/h)	Nivel presión sonora dB(A)	Peso aprox. (Kg)
		220-277V	380-480V				
HBA-31-2T	3456	2,24	1,29	0,55	2900	77	25
HBA-31-2M	3372	3,5	-	0,55	2900	77	26
HBA-31-4T	1638	1,25	0,72	0,25	1600	66	24
HBA-31-4M	1656	2,15	-	0,25	1600	66	25
HBA-40-2T	3444	4,35	2,5	1,1	6200	82	45
HBA-40-2M	3372	6,8	-	1,1	6200	82	46
HBA-40-4T	1650	1,67	0,96	0,37	3200	75	40
HBA-45-2T	3504	10,09	5,8	3	8550	84	57
HBA-50-4T	1698	2,87	1,65	0,75	6750	76	73
HBA-63-4T	1722	4,17	2,4	1,1	11150	77	91
HBA-71-4T	1734	15,3	8,8	4	15850	79	164
HBA-71-6T	1086	2,75	1,58	0,55	11200	74	140
HBA-80-6T	1122	5,22	3	1,1	14900	77	190
HBA-100-6T	1122	5,22	3	1,1	21700	80	260

Dimensiones mm

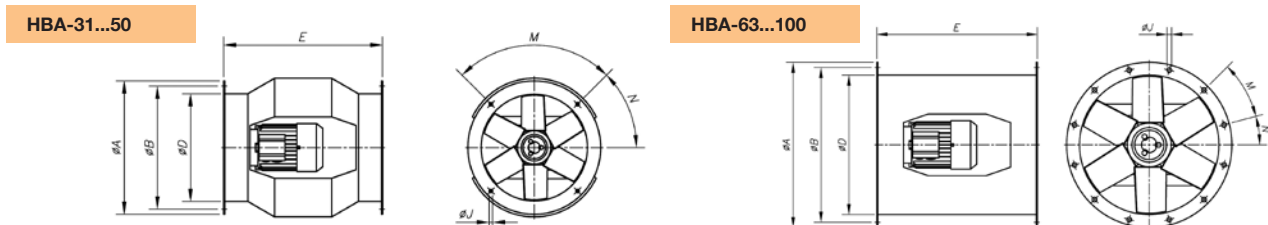

Modelo	ØA	ØB	ØD	E	ØJ	M	N
HBA-31	385	355	308	460	10	4x90°	45°
HBA-40	490	450	410	580	12	8x45°	22'5°
HBA-45	540	500	460	640	12	8x45°	22'5°
HBA-50	600	560	514	730	12	12x30°	15°
HBA-63	730	690	640	730	12	12x30°	15°
HBA-71	810	770	710	770	12	16x22'5°	11'25°
HBA-80	900	860	800	830	12	16x22'5°	11'25°
HBA-100	1115	1070	1000	1270	15	16x22'5°	11'25°

Curvas características

Q= Caudal en m³/h, m³/s y cfm.

Pe= Presión estática en mmH₂O, Pa e inwg.

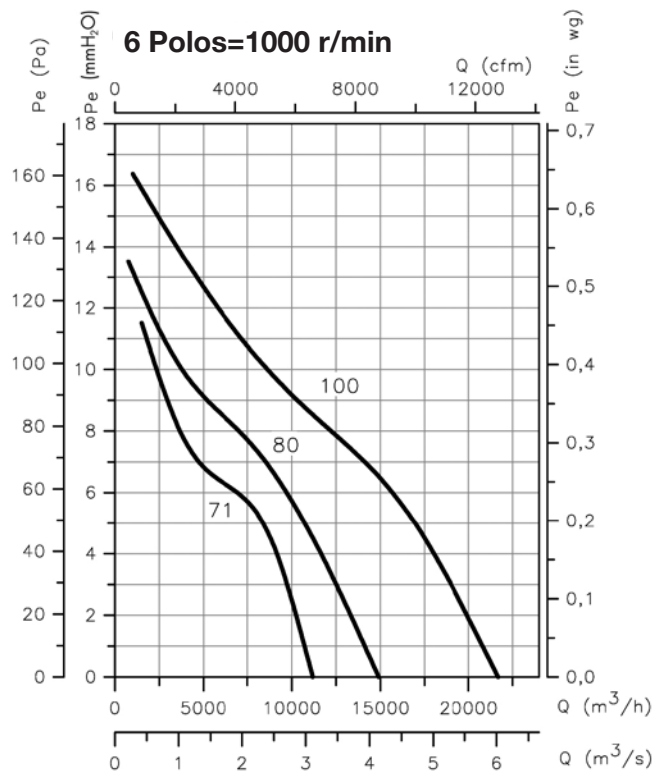
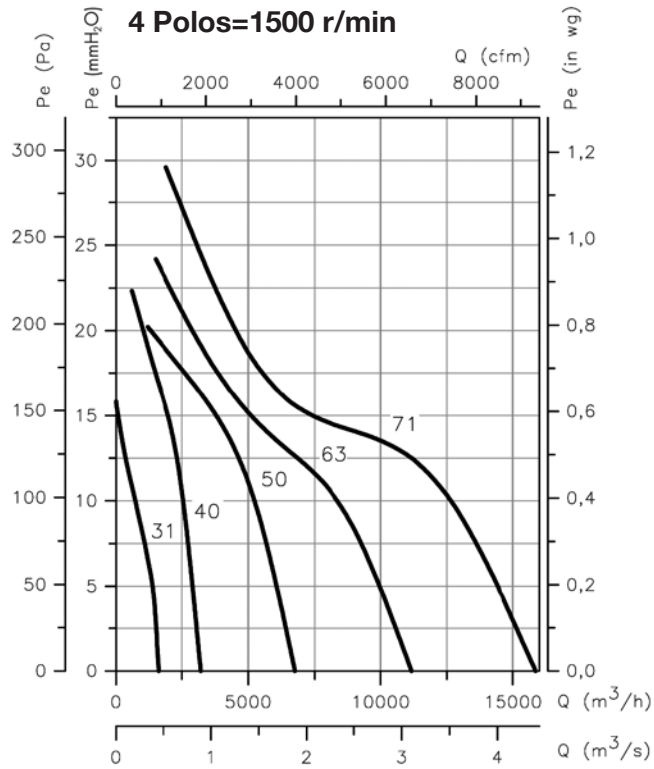
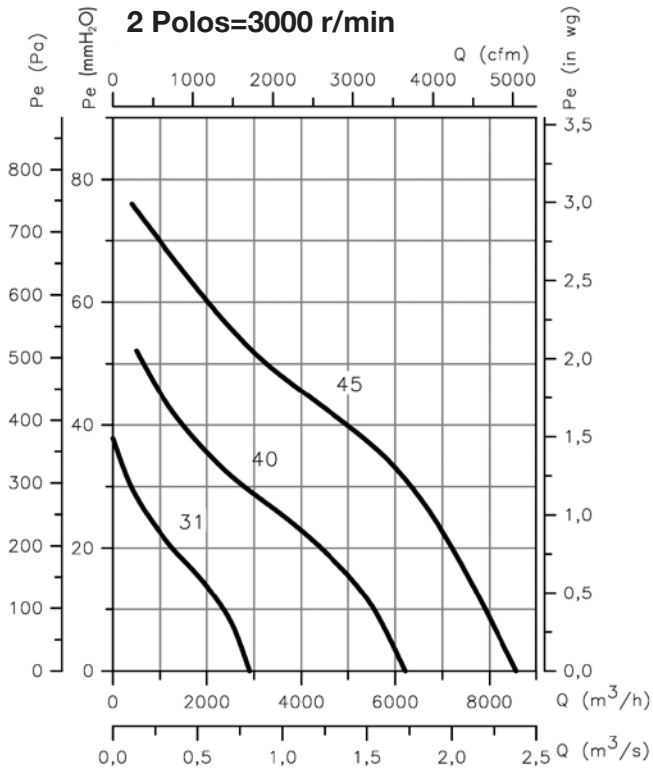

Accesorios



EXTRACTORES CENTRÍFUGOS

107

CI-CO  Jet fans centrifugos de inducción y de gran alcance con bajo perfil 110	CMX  Extractores centrifugos tipo VENT-SET, accionados a transmisión con turbina a reacción 111	CBD  Ventiladores centrifugos de baja presión y doble aspiración, con motor directo 120	CJBD/ALG  Unidades de ventilación con perfilera de aluminio y chapa de acero galvanizada aisladas acústicamente 123	CBX  Ventiladores centrifugos de doble aspiración, accionados a transmisión 126
CBXC  Ventiladores centrifugos de doble aspiración, accionados a transmisión 126	CBXR  Ventiladores centrifugos de doble aspiración, accionados a transmisión 126	CBXT  Ventiladores centrifugos de doble aspiración, accionados a transmisión 126	CJBX/ALG  Unidades de ventilación a transmisión con perfilera de aluminio y chapa de acero galvanizada, aisladas acústicamente 136	CDXR  Ventiladores a transmisión de doble aspiración 144
CDXRT  Ventiladores a transmisión de doble aspiración 144	CJDXR  Unidades de ventilación a transmisión de doble aspiración 144	CSXR  Ventiladores de simple aspiración a transmisión 153	CSXRT  Ventiladores de simple aspiración a transmisión 153	CJSXR  Unidades de ventilación de simple aspiración a transmisión 153
TSA  Ventiladores de simple aspiración a transmisión 165	TSAT  Ventiladores de simple aspiración a transmisión 165	CJTSA  Unidades de ventilación de simple aspiración a transmisión 165	CJBR  Unidades de ventilación aisladas acústicamente con panel tipo sándwich, con sentido lineal del aire entre aspiración e impulsión 173	CMP  Ventiladores centrifugos de media presión equipados con turbina en chapa de acero o aluminio 175
CMR  Ventiladores centrifugos de media presión y de gran robustez 183	CMA  Ventiladores centrifugos de media presión con turbina en fundición de aluminio 188	CPV  Ventiladores centrifugos anticorrosivos de material plástico 191	CA  Ventiladores centrifugos de alta presión en fundición de aluminio 196	CAS  Ventiladores centrifugos de alta presión en chapa de acero 199
CAS-S  Ventiladores centrifugos de alta presión en chapa de acero con atenuador acústico 199				



VENTILADORES CENTRÍFUGOS

Sodeca se ha especializado desde sus orígenes en el diseño y la fabricación de ventiladores y sus accesorios para aplicaciones industriales.

La unión de la experiencia adquirida durante décadas de trabajo con ventiladores, junto con la tecnología aportada por ingenieros distribuidos en diferentes departamentos, ha permitido que Sodeca se sitúe entre los mayores fabricantes de ventilación industrial del mundo.

Las aplicaciones industriales requieren gran capacidad de adaptación a las especificaciones de cada proyecto y flexibilidad en la fabricación, para cumplir con las necesidades reales de cada cliente.

Para cumplir con este objetivo Sodeca dispone de una línea de productos Standard y una línea de productos de fabricación especial, para la construcción de ventiladores adaptados a las exigencias de nuestros clientes.

Durante años se ha invertido de forma constante, en el desarrollo de procesos y aplicaciones internas, para conseguir la fabricación y el suministro de ventiladores industriales especiales, con un tiempo de diseño y fabricación extremadamente reducido.

El trabajo en equipo de nuestro departamento de ingeniería, junto con universidades y centros tecnológicos, así como la estrecha colaboración entre los departamentos de diseño de nuestros colaboradores externos, hace posible conseguir innovadoras soluciones de ventilación industrial en un corto plazo de tiempo.

A lo largo de nuestra historia hemos desarrollado todo tipo de tecnología en ventiladores para aplicaciones industriales que actualmente están repartidos por todo el mundo, nuestro objetivo es seguir invirtiendo en este sector para seguir siendo uno de los fabricantes de ventiladores industriales más reconocidos en el mundo.



NUESTRAS TURBINAS

Turbina NEOLINEO

Turbina helicocentrífuga, para sentido del aire lineal, con presiones elevadas



Turbina CBD

Turbina multipala de doble aspiración, con alabes a acción, de baja presión



Turbina CDXR

Turbina con alabes a reacción, de doble aspiración, para grandes caudales



Turbina CMP

Turbina multipala de simple aspiración, con alabes a acción, de media presión



Turbina CMX

Turbina con alabes a reacción, de simple aspiración y media presión



Turbina CMR

Turbina con alabes a reacción, de simple aspiración y gran robustez, para grandes caudales y presiones, con alto rendimiento



Turbina CMRH

Turbina con alabes a reacción, de simple aspiración y gran robustez, diseñada para trabajar con altas temperaturas



Turbina CA-CAM

Turbinas diseñadas para obtener altas presiones



Turbina CMT

Turbinas de gran robustez, diseñadas para el transporte de polvo y materiales sólidos



CI-CO

Jet fans centrífugos de inducción y de gran alcance con bajo perfil

Jet fans centrífugos de inducción y de gran alcance con bajo perfil, para movimiento de aire y extracción de CO en aparcamientos.



Pies fijación

Ventilador:

- Envoltente en chapa de acero
- Turbina con álabes a reacción en chapa de acero de gran robustez
- Interruptor de seguridad de la serie INT incorporado en el ventilador
- Pies fijación incluidos

Motor:

- Motores clase F, con rodamientos a bolas, protección IP55, de 1 ó 2 velocidades según modelo
- Trifásicos 220-254V. 60Hz. y 380-440V. 60Hz.
- Temperatura máxima del aire a transportar: -20°C +40°C.

Acabado:

- Anticorrosivo en resina de poliéster polimerizada a 190 °C, previo desengrase con tratamiento nanotecnológico libre de fosfatos.

Bajo demanda:

- Versión homologada para evacuación de humos según norma EN 12101-3 (ver serie CI)

Código de pedido

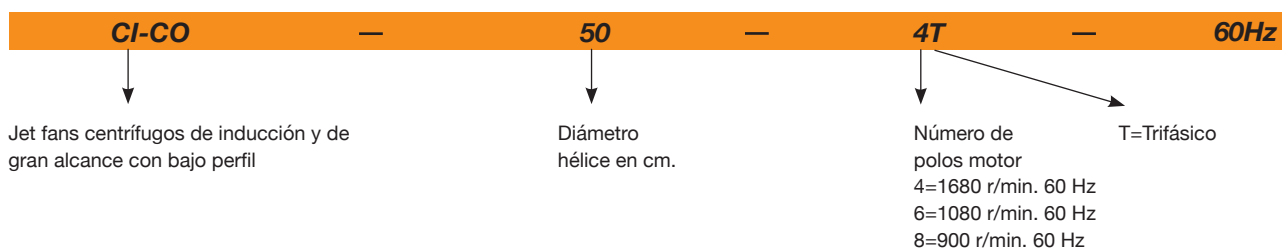

Características técnicas

60Hz

Modelo	Velocidad (r/min)	Intensidad máxima admisible (A)		Caudal (m³/h)	Empuje (N)	Potencia instalada (kW)	Presión sonora LpA a 1m dB(A)	Peso aprox. (Kg)
		220-254V.	380-440V.					
CI-CO-50-4T	1674	5,00	2,90	6050	50	1,20	78	83
CI-CO-50-4/8T	1674/780		2,90 / 1,20	6050 / 3020	50 / 13	1,20 / 0,30	78/63	83
CI-CO-75-4T	1740	9,00	5,20	8080	75	2,20	85	139
CI-CO-75-4/8T	1740/876		5,20 / 2,05	8080 / 4040	75 / 19	2,20 / 0,37	85/70	139
CI-CO-100-4T	1734	9,90	5,70	9340	100	2,40	89	141
CI-CO-100-4/8T	1734/858		5,70 / 2,20	9340 / 4670	100 / 25	2,40 / 0,55	89/14	141

Dimensiones mm

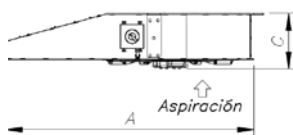
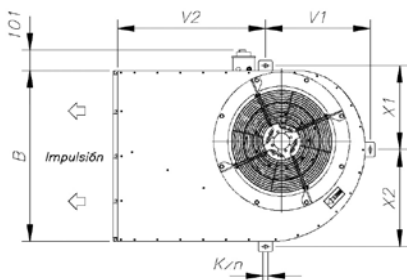

Modelo	A	B	C	V2	V1	X1	X2	Kxn
CI-CO-50	1240	840	272,5	741,5	524,5	413	477	12x26
CI-CO-75	1778	1040	311	1143	662	494	596	12x26
CI-CO-100	1778	1040	323	1143	662	494	596	12x26

Accesorios



CMX

Extractores centrífugos tipo VENT-SET, accionados a transmisión con turbina a reacción

Extractores centrífugos tipo VENT-SET, accionados a transmisión con turbina a reacción equipados con motor eléctrico, conjunto de poleas, correas y protectores normalizados según norma EN-294 y ISO-13852



Turbina a reacción de alto rendimiento, y gran robustez

Ventilador:

- Envoltente en chapa de acero.
- Turbina con álabes a reacción en chapa de acero.
- Conjunto de poleas, correas y protectores normalizados según norma EN-294 y ISO-13852.
- Equipados con trampilla de inspección.

Motor:

- Motores de eficiencia IE3 para potencias iguales o superiores a 0,75kW, excepto monofásicos, 2 velocidades y 8 polos.
- Motores clase F, con rodamientos a bolas, protección IP55.
- Motor Multitensión, diseño especial válido para: 220/380V 60Hz, 254/440V 60Hz, 265/460V 60Hz, 277/480V 60Hz
- Temperatura máxima del aire a transportar: -20°C + 150°C.

Acabado:

- Anticorrosivo en resina de poliéster polimerizada a 190 °C, previo desengrase con tratamiento nanotecnológico libre de fosfatos.

Bajo demanda:

- Bobinados especiales para diferentes tensiones.

Código de pedido



CMX: Extractores centrífugos accionados a transmisión con turbina a reacción

Tamaño turbina

Potencia motor (c.v.)

60Hz

Características técnicas

Modelo	Velocidad (r/min)	Intensidad máxima admisible (A)		Potencia instalada (kW)	Caudal máximo (m³/h)	Peso aprox. (Kg)
		220-277V	380-480V			
CMX-250-0,25	1920	0,96	0,55	0,18	1575	22
CMX-250-0,33	2140	1,36	0,78	0,25	1755	23
CMX-250-0,5	2435	1,84	1,06	0,37	2000	24
CMX-250-0,75	2775	2,57	1,49	0,55	2275	26
CMX-250-1	3075	2,78	1,60	0,75	2525	28
CMX-250-1,5	3490	4,20	2,40	1,10	2865	30
CMX-280-0,33	1760	1,36	0,78	0,25	2030	25
CMX-280-0,5	2010	1,84	1,06	0,37	2315	26
CMX-280-0,75	2305	2,57	1,49	0,55	2655	28
CMX-280-1	2560	2,78	1,60	0,75	2950	30
CMX-280-1,5	2910	4,20	2,40	1,10	3355	32
CMX-280-2	3225	5,44	3,13	1,50	3720	35
CMX-315-0,5	1650	1,84	1,06	0,37	2700	30
CMX-315-0,75	1880	2,57	1,49	0,55	3075	32
CMX-315-1	2095	2,78	1,60	0,75	3430	34
CMX-315-1,5	2375	4,20	2,40	1,10	3885	36
CMX-315-2	2655	5,44	3,13	1,50	4345	39
CMX-315-3	3000	7,77	4,47	2,20	4910	42
CMX-315-4	3380	10,18	5,88	3,00	5530	47
CMX-355-0,5	1385	1,84	1,06	0,37	3235	39
CMX-355-0,75	1580	2,57	1,49	0,55	3685	41
CMX-355-1	1765	2,78	1,60	0,75	4120	44
CMX-355-1,5	2010	4,20	2,40	1,10	4690	46
CMX-355-2	2225	5,44	3,13	1,50	5190	48
CMX-355-3	2530	7,77	4,47	2,20	5905	53
CMX-355-4	2860	10,18	5,88	3,00	6675	57
CMX-355-5,5	3100	13,60	7,82	4,00	7235	63
CMX-400-0,75	1320	2,28	1,31	0,55	4375	49
CMX-400-1	1465	3,10	1,79	0,75	4855	52
CMX-400-1,5	1665	4,03	2,32	1,10	5515	54
CMX-400-2	1845	5,96	3,44	1,50	6110	56
CMX-400-3	2100	8,36	4,83	2,20	6955	59
CMX-400-4	2370	10,18	5,88	3,00	7850	64
CMX-400-5,5	2610	13,60	7,82	4,00	8645	72
CMX-450-0,75	1095	2,28	1,31	0,55	5045	61

Características técnicas

Modelo	Velocidad (r/min)	Intensidad máxima admisible (A)		Potencia instalada (kW)	Caudal máximo (m³/h)	Peso aprox. (Kg)
		220-277V	380-480V			
CMX-450-1	1220	3,10	1,79	0,75	5620	64
CMX-450-1,5	1390	4,03	2,32	1,10	6405	66
CMX-450-2	1540	5,96	3,44	1,50	7095	68
CMX-450-3	1750	8,36	4,83	2,20	8065	72
CMX-450-4	1980	10,18	5,88	3,00	9120	76
CMX-450-5,5	2180	13,60	7,82	4,00	10045	85
CMX-450-7,5	2420		10,50	5,50	11150	95
CMX-450-10	2670		14,50	7,50	12300	100
CMX-500-1	1005	3,10	1,79	0,75	6465	86
CMX-500-1,5	1140	4,03	2,32	1,10	7330	88
CMX-500-2	1270	5,96	3,44	1,50	8165	90
CMX-500-3	1445	8,36	4,83	2,20	9290	93
CMX-500-4	1635	10,96	6,33	3,00	10510	98
CMX-500-5,5	1800	14,10	8,12	4,00	11570	107
CMX-500-7,5	2000		10,50	5,50	12855	116
CMX-500-10	2220		14,50	7,50	14270	121
CMX-500-15	2300		20,20	11,00	14785	155
CMX-560-2	1035	5,96	3,44	1,50	9885	100
CMX-560-3	1185	8,36	4,83	2,20	11360	103
CMX-560-4	1340	10,96	6,33	3,00	12880	108
CMX-560-5,5	1475	14,10	8,12	4,00	14210	117
CMX-560-7,5	1640		11,60	5,50	15830	122
CMX-560-10	1815		14,50	7,50	17555	132
CMX-560-15	2065		20,20	11,00	20010	166
CMX-630-3	1010	8,36	4,83	2,20	12120	119
CMX-630-4	1140	10,96	6,33	3,00	13680	123
CMX-630-5,5	1255	14,10	8,12	4,00	15060	132
CMX-630-7,5	1395		11,60	5,50	16740	138
CMX-630-10	1550		14,50	7,50	18600	147
CMX-630-15	1760		20,20	11,00	21120	181
CMX-630-20	1900		27,50	15,00	22800	202
CMX-710-4	960	10,96	6,33	3,00	17065	186
CMX-710-5,5	1060	14,10	8,12	4,00	18845	195
CMX-710-7,5	1180		11,60	5,50	20980	200
CMX-710-10	1305		14,20	7,50	23200	210
CMX-710-15	1485		20,20	11,00	26400	244
CMX-710-20	1670		27,50	15,00	29690	265
CMX-710-25	1750		35,00	18,50	31110	285
CMX-800-4	765	10,96	6,33	3,00	19975	226
CMX-800-5,5	845	14,10	8,12	4,00	22065	234
CMX-800-7,5	940		11,60	5,50	24545	240
CMX-800-10	1040		14,50	7,50	27155	250
CMX-800-15	1185		20,20	11,00	30940	284
CMX-800-20	1330		27,50	15,00	34730	305
CMX-800-25	1420		35,00	18,50	37080	325
CMX-900-4	640	10,96	6,33	3,00	21200	281
CMX-900-5,5	705	14,10	8,12	4,00	23355	289
CMX-900-7,5	785		11,60	5,50	26005	295
CMX-900-10	870		14,50	7,50	28820	305
CMX-900-15	990		20,20	11,00	32795	339
CMX-900-20	1100		27,50	15,00	36440	360
CMX-900-25	1150		35,00	18,50	38095	380
CMX-900-30	1200		42,00	22,00	39750	399
CMX-1000-5,5	575	14,10	8,12	4,00	25555	342
CMX-1000-7,5	645		11,60	5,50	28665	348
CMX-1000-10	715		14,50	7,50	31780	358
CMX-1000-15	815		20,20	11,00	36220	392
CMX-1000-20	915		27,50	15,00	40665	413
CMX-1000-25	980		35,00	18,50	43555	432
CMX-1000-30	1040		42,00	22,00	46220	452
CMX-1000-40	1120		55,00	30,00	49780	506

Accesorios



INT

IAT

C2V

RPA

B

BD

BIC

ACE/400

CABLE BOX

AET

CENTRAL CO

VSD3/A-RFT

Dimensiones mm

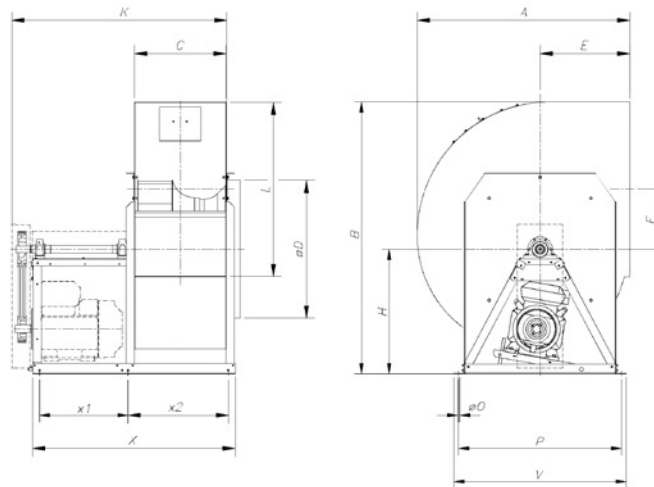

	A	B	C	L	øD	H	E	F	K	X	øO	P	V	x1	x2
CMX-250	437	637	180	320	248	336	209	111	582	572	10	370	410	270	242
CMX-280	468	707,5	197	361	278	376	215	121	600	590	10	410	450	270	260
CMX-315	522	741,5	223	404	313	400	236	139,5	748,5	691,5	12	454	504	315	306,5
CMX-355	582,5	839,5	247	453	353	450	261	158	772,5	715,5	12	496	546	315	330,5
CMX-400	651	933	274	507	398	500	290	179,5	799,5	742,5	12	542	592	315	357,5
CMX-450	727,5	1037	308	569	448	550	322	202,5	938,5	841,5	12	595	645	380	391,5
CMX-500	801	1140	344	638	498	600	352	221	974,5	887,5	12	654	704	380	437,5
CMX-560	892,5	1255	383	715	558	650	390	247,5	1171,5	1076,5	12	715	765	515	484
CMX-630	998,5	1449,5	432	801	628	769	434	280	1220,5	1125,5	12	780	830	515	533
CMX-710	1117	1507	479	902	708	730	481,5	316	1267,5	1172,5	14	890	930	515	580
CMX-800	1250	1615,5	533	1010	798	762	535	358,5	1321,5	1231,5	14	980	1050	515	614
CMX-900	1408	1475	595	1130	898	850	604	407	1383,5	1293,5	14	1080	1150	515	676
CMX-1000	1541	1966	663	1260	998	900	651	433	1559,5	1468,5	14	1180	1250	642	729,5

Curvas características

Q= Caudal en m³/h, m³/s y cfm.

Pe= Presión estática en mmH²O, Pa e inwg.

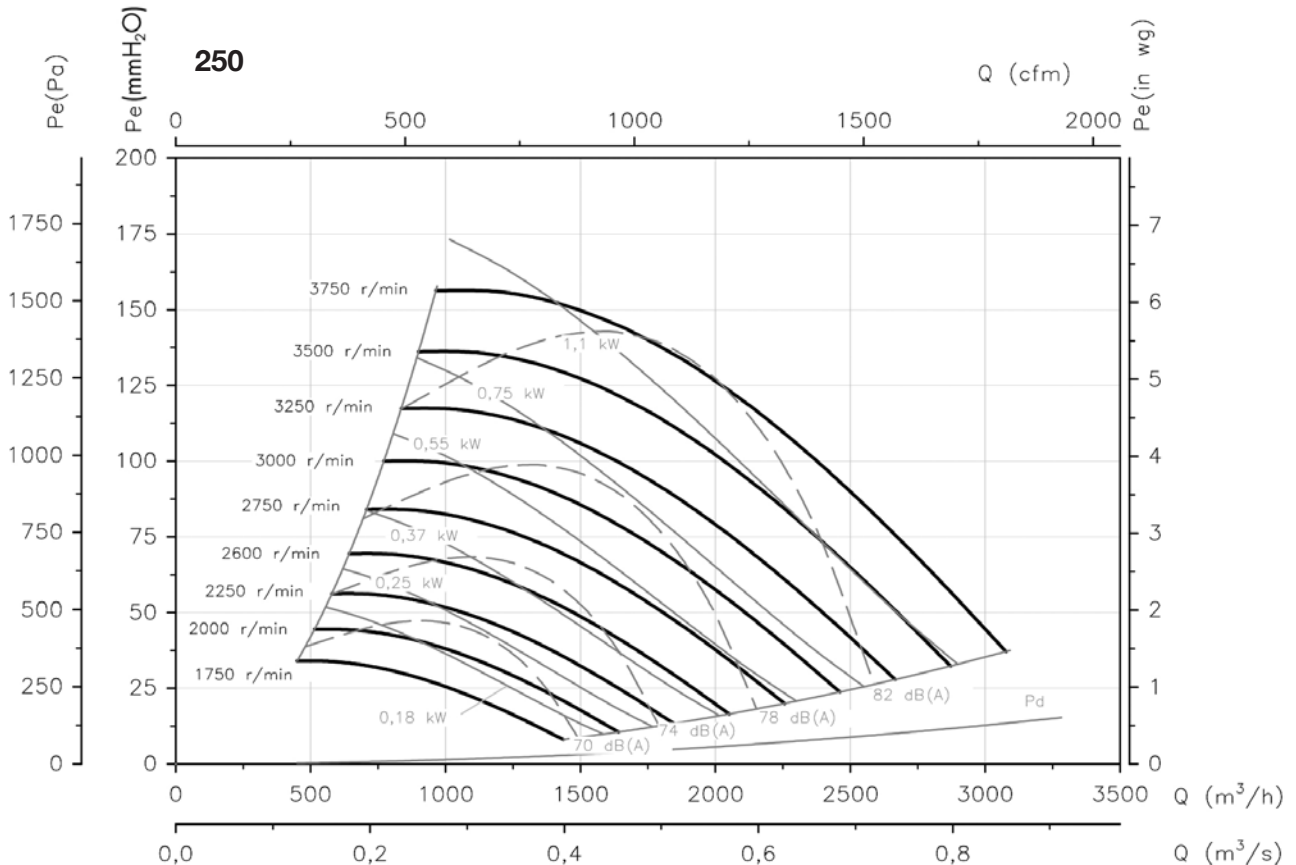

Curvas características

Q= Caudal en m³/h, m³/s y cfm.

Pe= Presión estática en mmH₂O, Pa e inwg.

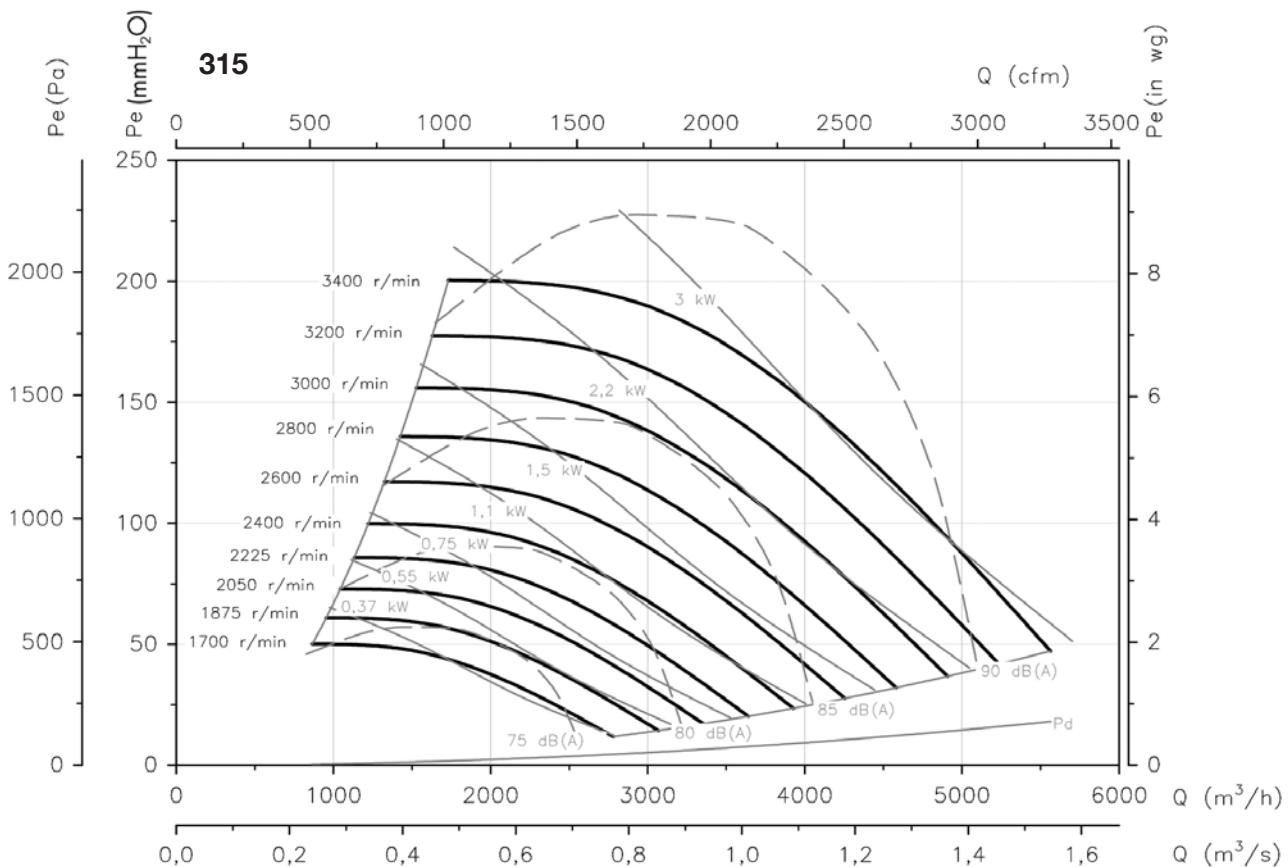
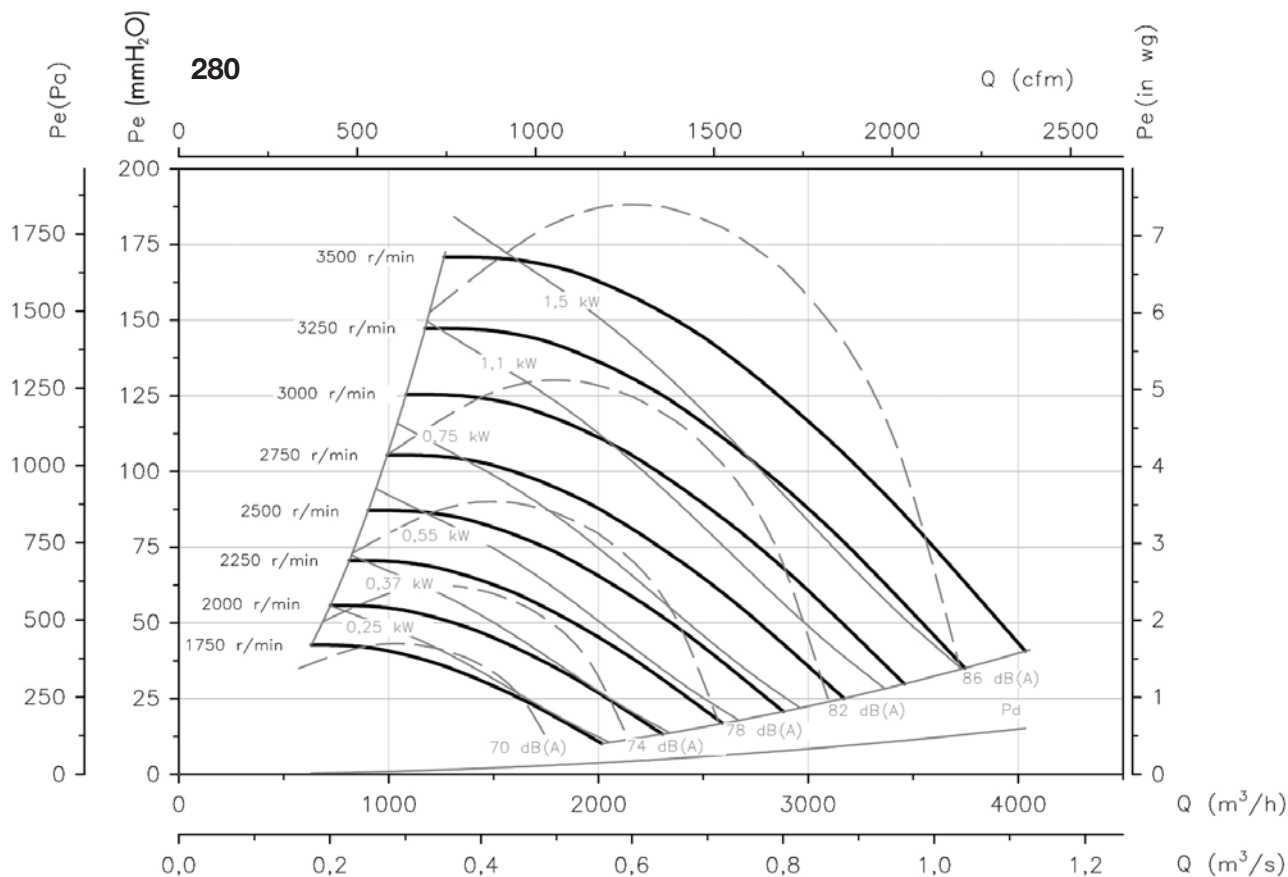

Curvas características

Q= Caudal en m³/h, m³/s y cfm.

Pe= Presión estática en mmH₂O, Pa e inwg.

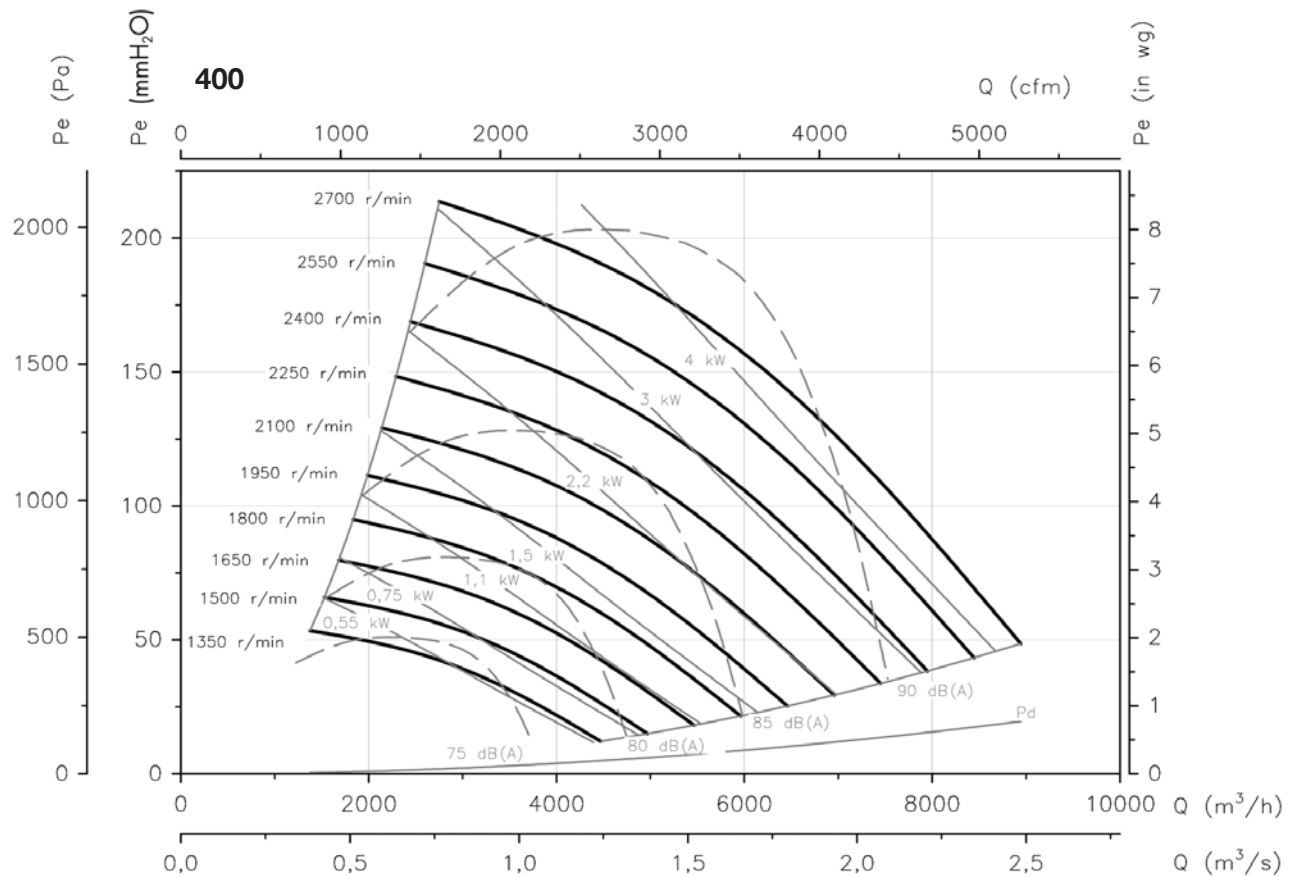
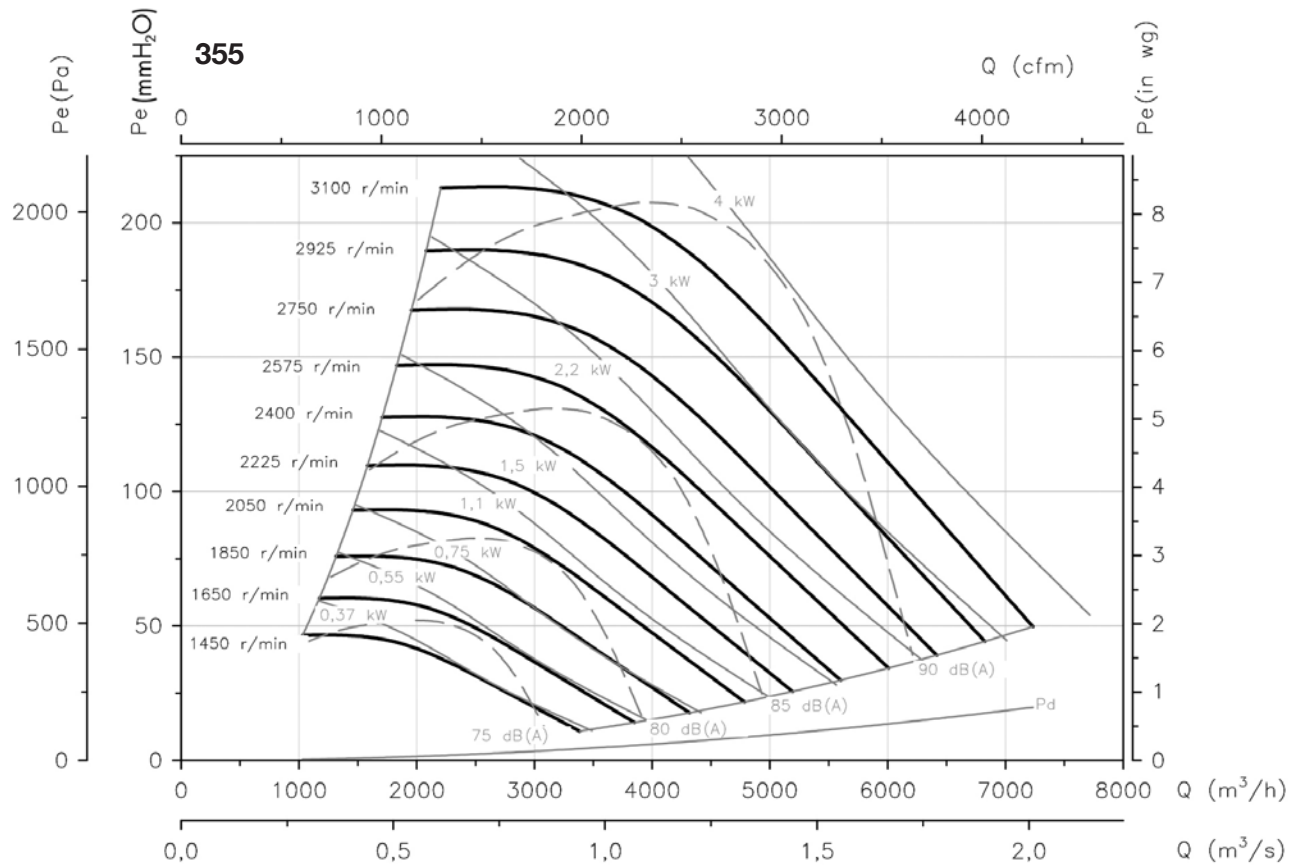

Curvas características

Q= Caudal en m³/h, m³/s y cfm.

Pe= Presión estática en mmH₂O, Pa e inwg.

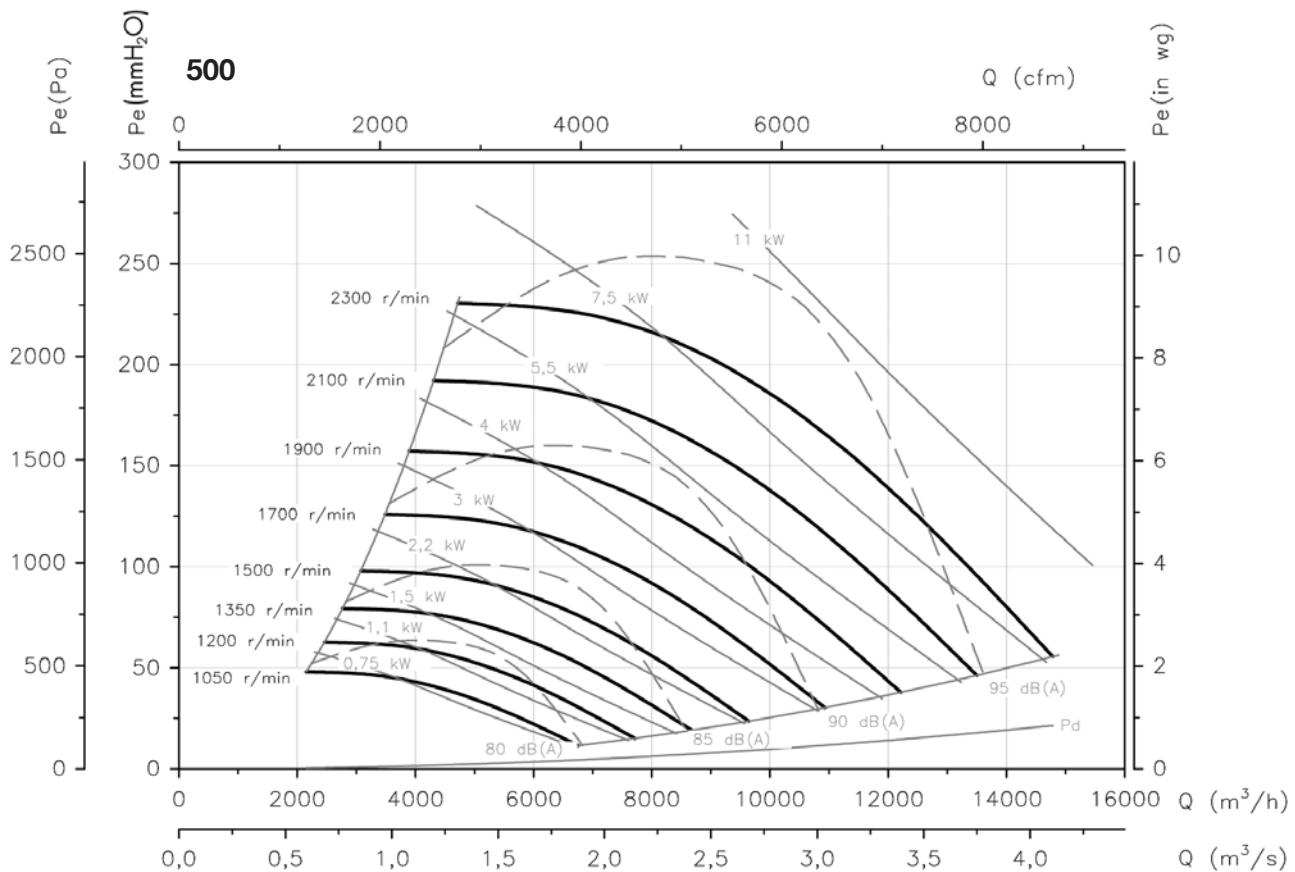
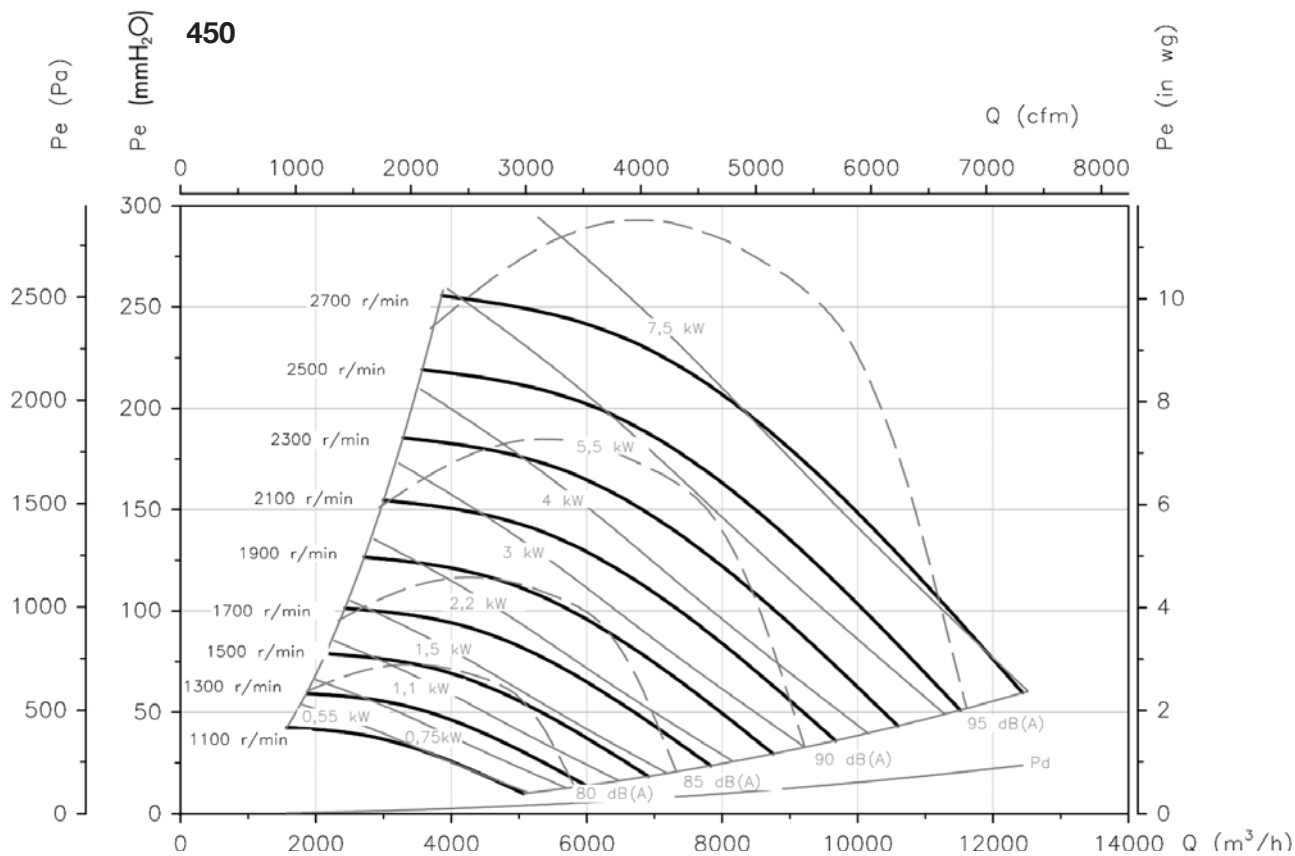

Curvas características

Q= Caudal en m³/h, m³/s y cfm.

Pe= Presión estática en mmH₂O, Pa e inwg.

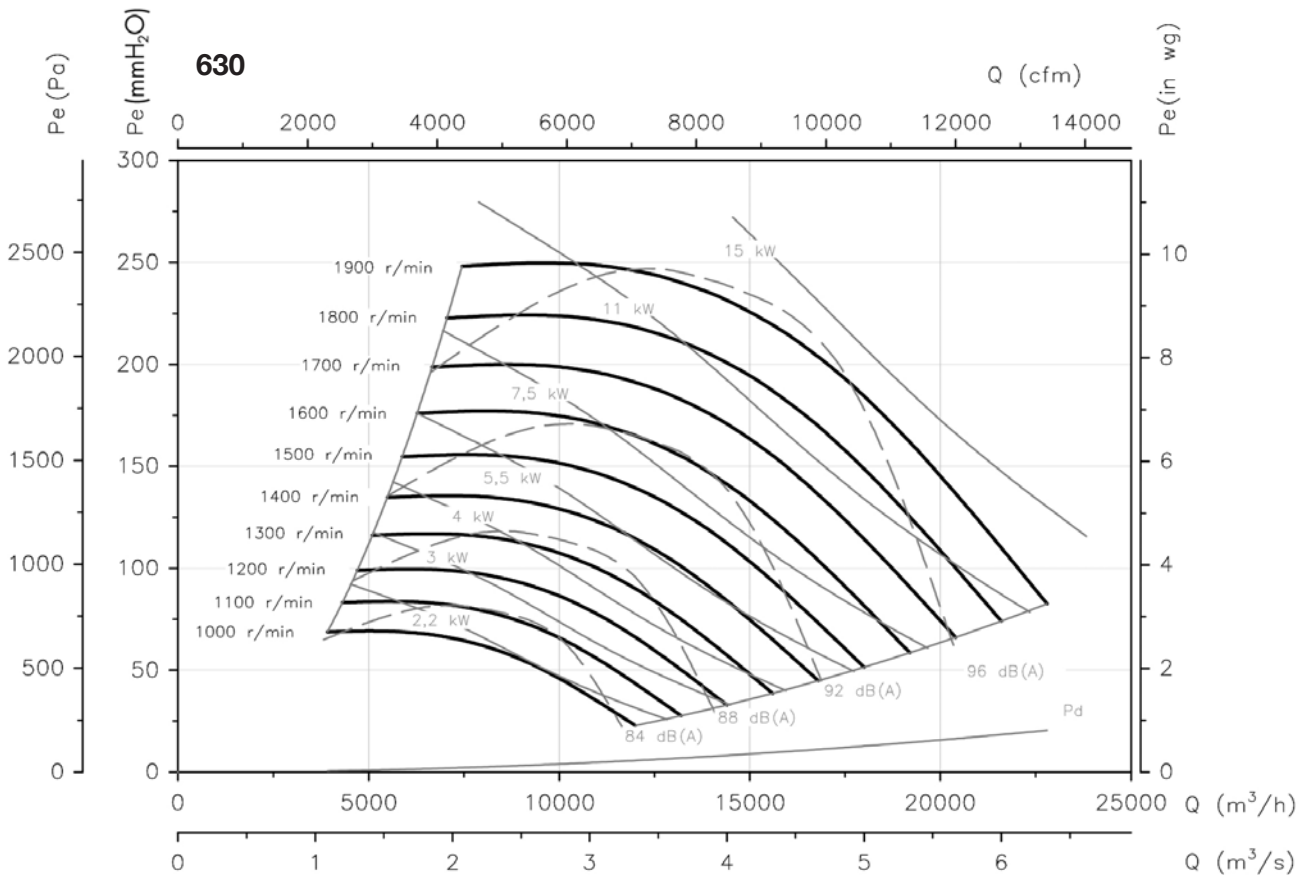
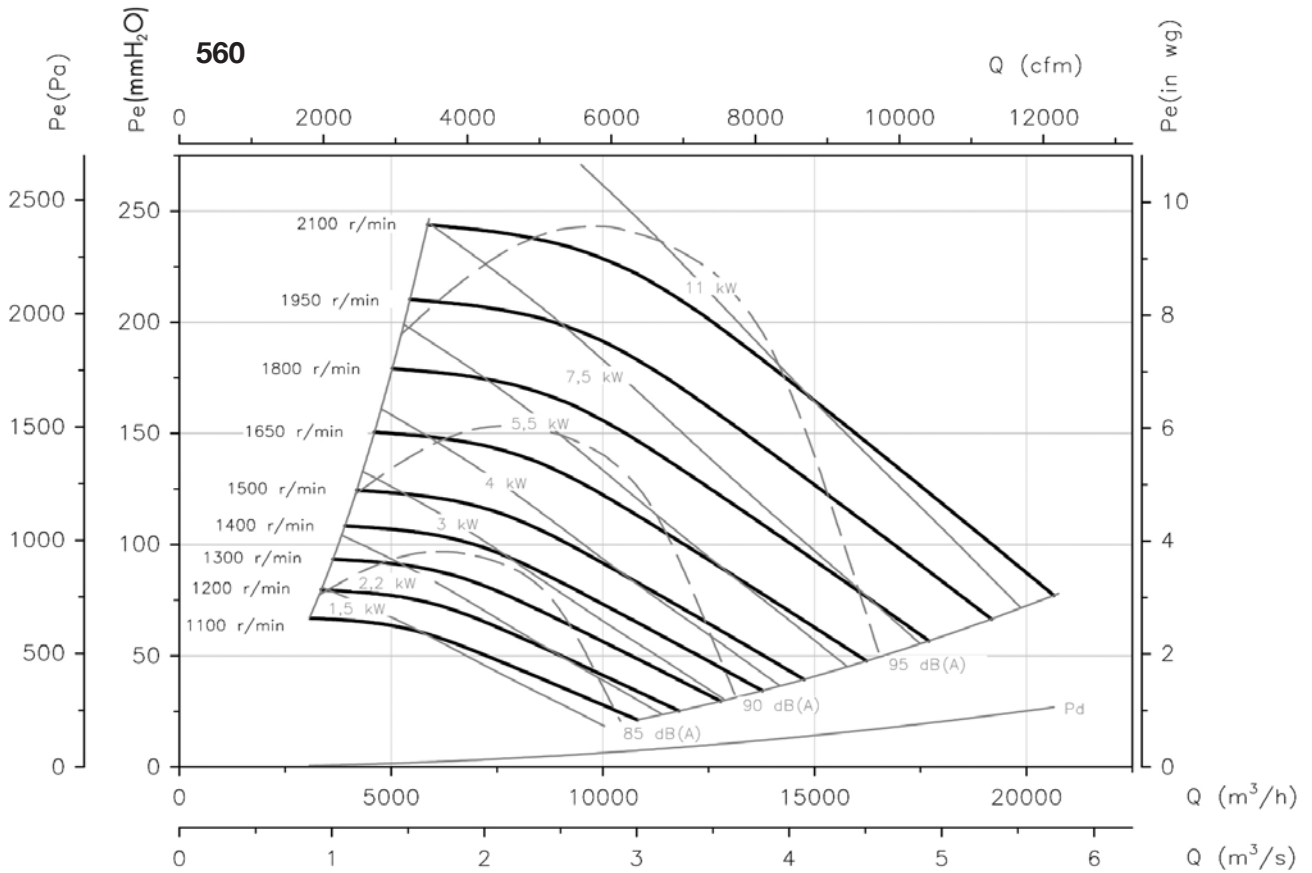

Curvas características

Q= Caudal en m³/h, m³/s y cfm.

Pe= Presión estática en mmH₂O, Pa e inwg.

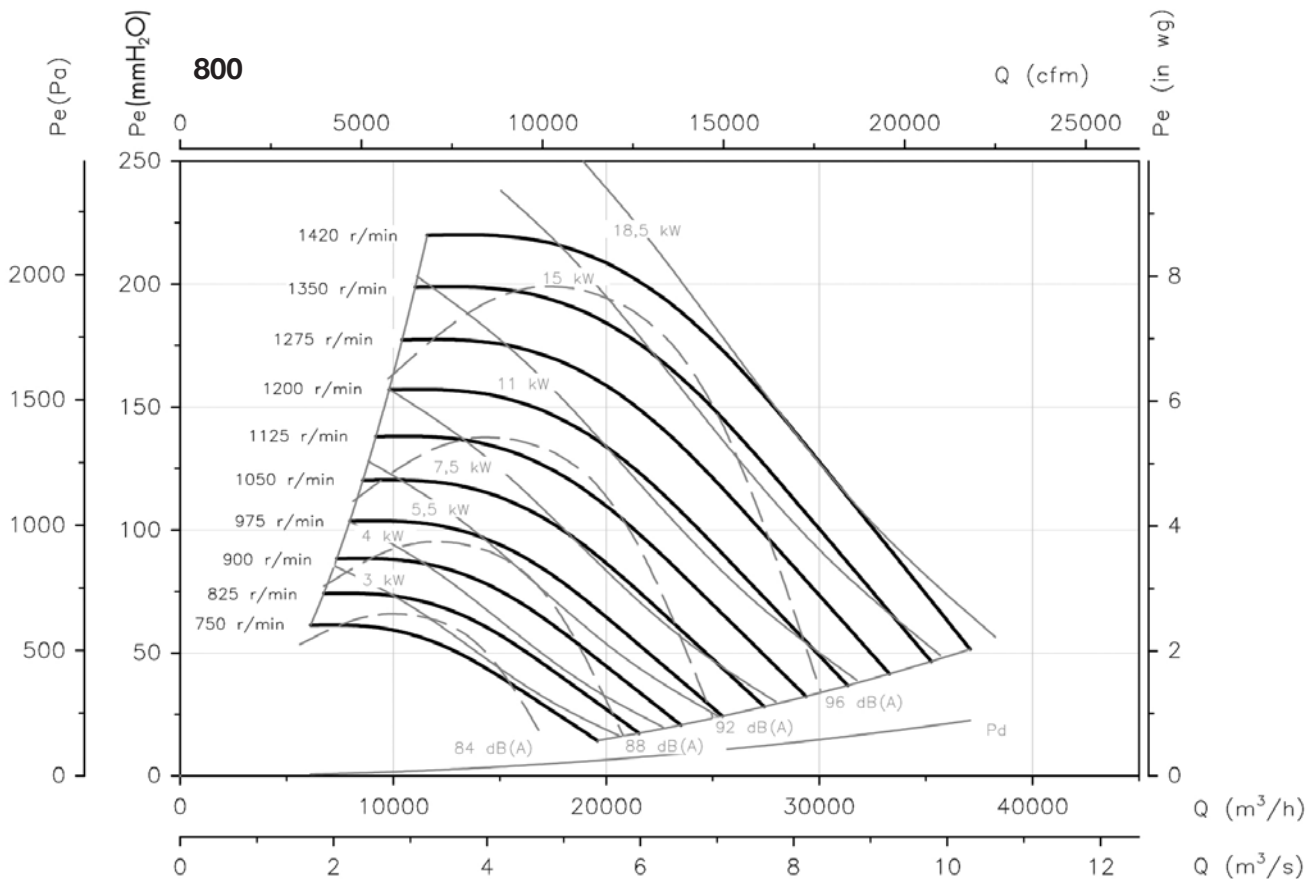
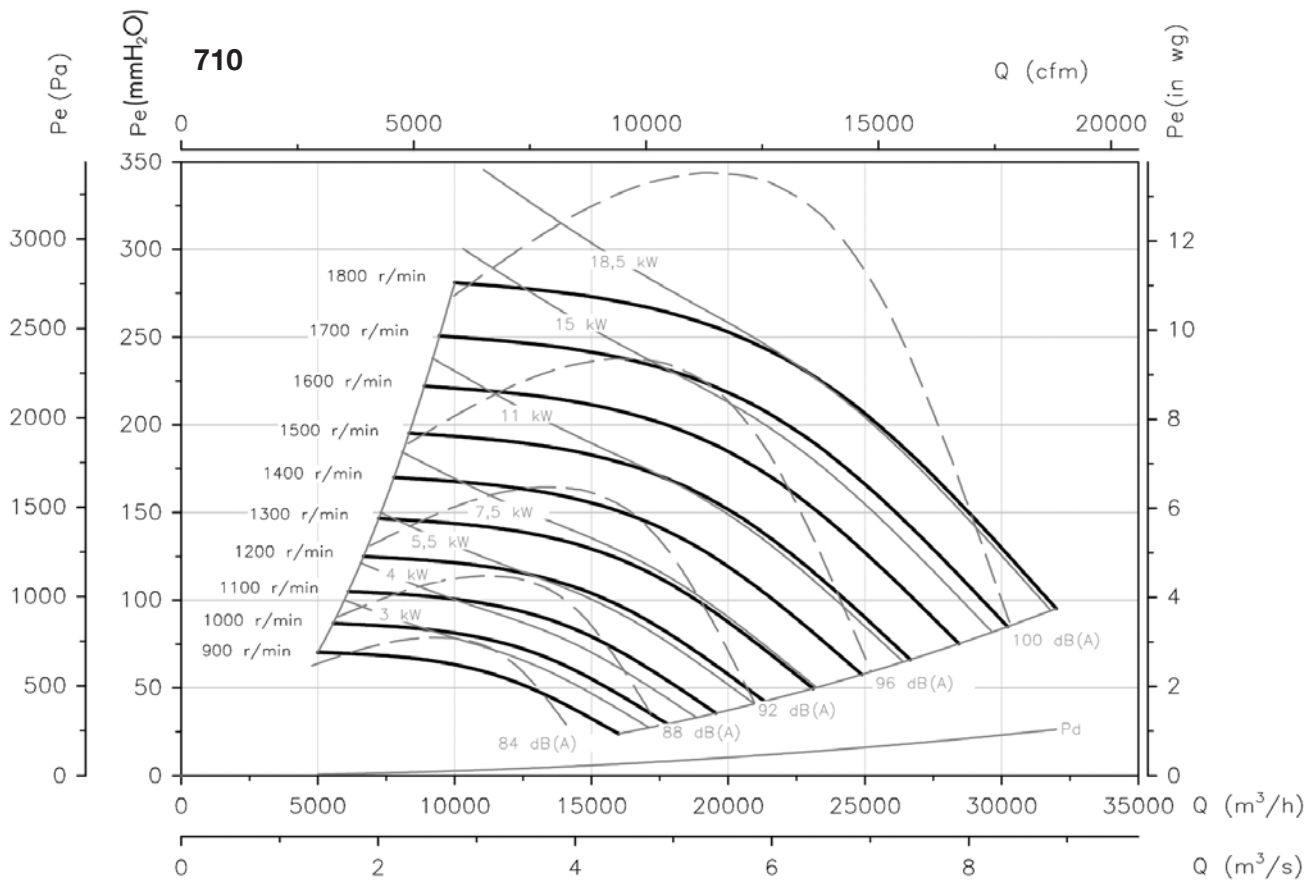

Curvas características

Q= Caudal en m³/h, m³/s y cfm.

Pe= Presión estática en mmH₂O, Pa e inwg.

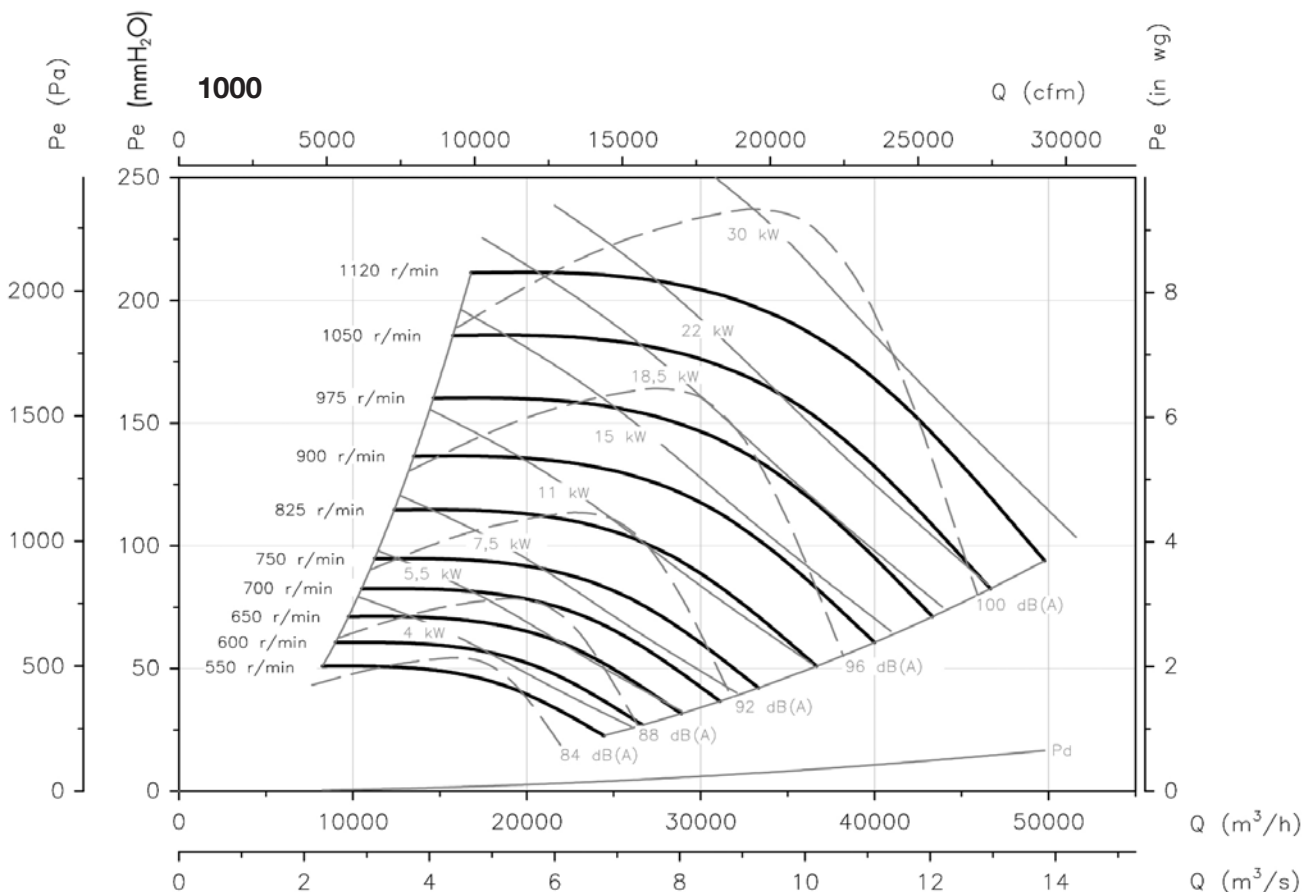
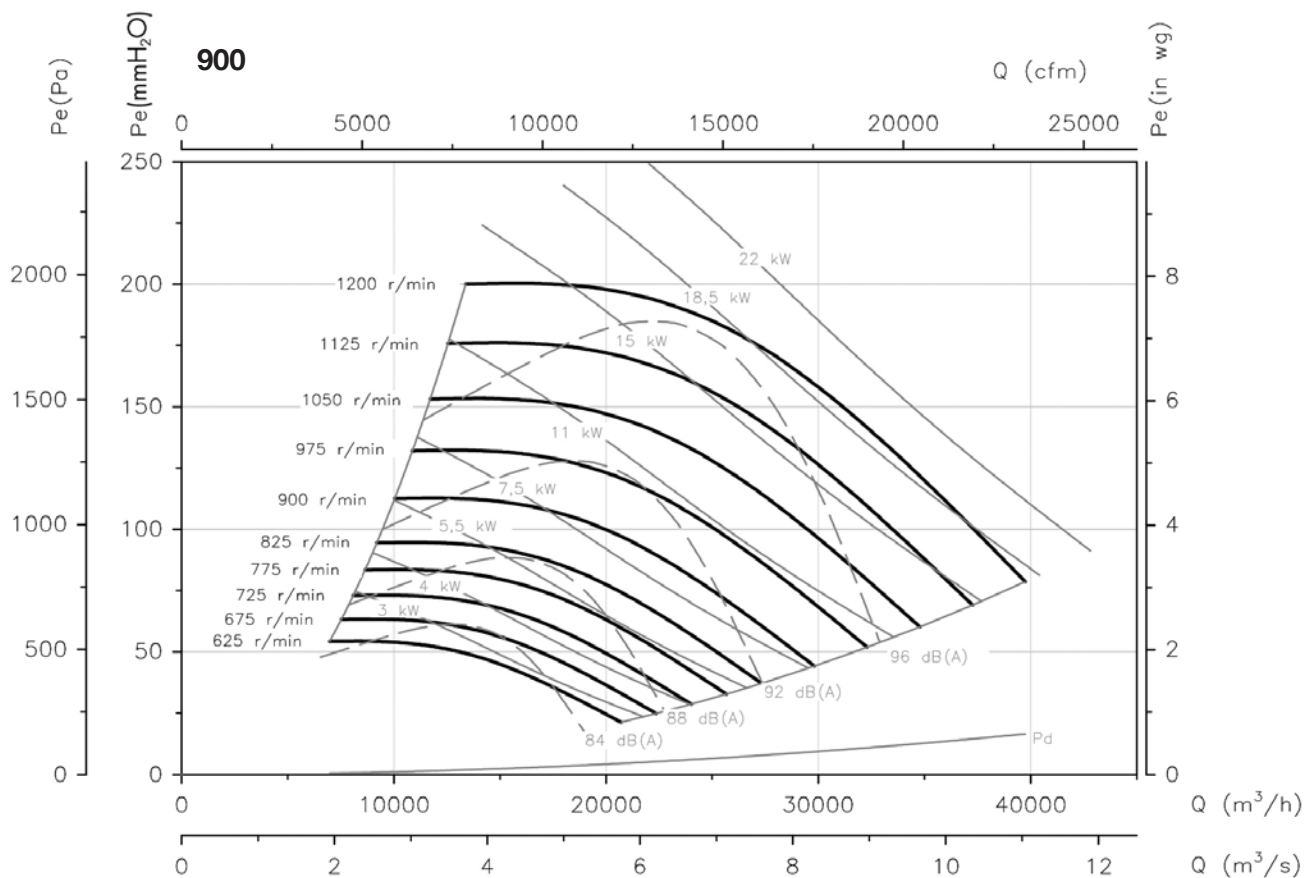

CBD

Ventiladores centrífugos de doble aspiración con motor directo y turbina con álabes hacia delante



Turbina de alta calidad y gran robustez, equilibrada dinámicamente según ISO 21940-11

Ventilador:

- Envoltente en chapa de acero galvanizado
- Turbina con álabes hacia delante, en chapa de acero galvanizado
- Se suministra con pies soporte PSB

Motor:

- High efficiency (HE) motores para cumplimiento de ErP 2015
- Motores cerrados con protector térmico incorporado, clase F, con rodamientos a bolas, protección IP54
- Motor Multitensión, diseño especial válido para: 220/380V 60Hz, 254/440V 60Hz, 265/460V 60Hz, 277/480V 60Hz
- Temperatura máxima del aire a transportar: -20°C + 60°C

Acabado:

- Anticorrosivo en chapa de acero galvanizado

Código de pedido

CBD — **2525** — **4M** — **3/4** — **60Hz**

CBD: Ventiladores centrífugos de doble aspiración con motor directo y turbina con álabes hacia delante

Tamaño turbina mm
mm — pulg

1919	7/7
2525	9/9
2828	10/10
3333	12/12
3939	15/15

Número de polos motor
4=1680 r/min. 60 Hz
6=1080 r/min. 60 Hz

T=Trifásico
M=Monofásico

Potencia motor (c.v.)

Características técnicas

60Hz

Modelo	Velocidad máxima (r/min)	Equivalencia Pulgadas	Intensidad máxima admisible (A)		Potencia instalada (kW)	Caudal máximo (m³/h)	Nivel sonoro dB(A)	Peso aprox. (Kg)
			220-277V	380-480V				
CBD-1919-4M 1/5/HE	1476	7/7	1,40		0,15	1520	59	7
CBD-1919-6M 1/10/HE	984	7/7	0,85		0,07	1230	53	7
CBD-2525-4M 1/2/HE	1584	9/9	3,30		0,37	2800	66	13,2
CBD-2525-4M 3/4/HE	1572	9/9	4,50		0,55	3600	70	14
CBD-2525-6M 1/5/HE	1020	9/9	1,50		0,15	2200	60	11,5
CBD-2525-6M 1/3/HE	996	9/9	2,20		0,25	2700	62	12,7
CBD-2828-4M 1/2/HE	1584	10/10	3,30		0,37	2800	65	15,7
CBD-2828-4M 3/4/HE	1572	10/10	4,50		0,55	3950	70	16,5
CBD-2828-6M 1/3/HE	996	10/10	2,20		0,25	3200	62	15,2
CBD-2828-6M 3/4/HE	1080	10/10	4,50		0,55	3600	64	21
CBD-3333-6T 1 1/2/HE	1080	12/12	6,60	3,80	1,1	7800	75	24,5
CBD-3333-6M 3/4/HE	1020	12/12	5,00		0,55	4900	64	23
CBD-3333-6M 1/HE	1020	12/12	6,00		0,75	6000	71	24
CBD-3939-6T 3/HE	1068	15/15	10,90	6,30	2,2	11900	75	39

Características acústicas

Espectro de potencia sonora Lw(A) en dB(A) por banda de frecuencia en Hz. Velocidad máxima

Modelo	63	125	250	500	1000	2000	4000	8000	Modelo	63	125	250	500	1000	2000	4000	8000
CBD-1919-4M 1/5/HE	29	44	55	63	65	64	63	55	CBD-2828-4M 3/4/HE	40	55	66	74	76	75	74	66
CBD-1919-6M 1/10/HE	23	38	49	57	59	58	57	49	CBD-2828-6M 1/3/HE	32	47	58	66	68	67	66	58
CBD-2525-4M 1/2/HE	36	51	62	70	72	71	70	62	CBD-2828-6M 3/4/HE	34	48	60	68	70	69	67	60
CBD-2525-4M 3/4/HE	40	55	66	74	76	75	74	66	CBD-3333-6T 1 1/2/HE	45	60	71	79	81	80	79	71
CBD-2525-6M 1/5/HE	30	45	56	64	66	65	64	56	CBD-3333-6M 3/4/HE	34	49	60	68	70	69	68	60
CBD-2525-6M 1/3/HE	32	47	58	66	68	67	66	58	CBD-3333-6M 1/HE	41	56	67	75	77	76	75	67
CBD-2828-4M 1/2/HE	35	50	61	69	71	70	69	61	CBD-3939-6T 3/HE	48	62	74	81	84	83	81	73

Dimensiones mm

CBD- 1919...3333

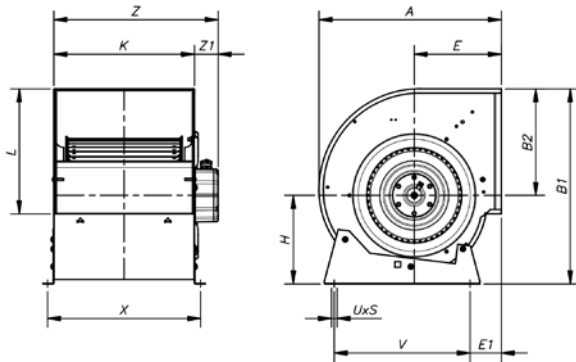

CBD- 3939

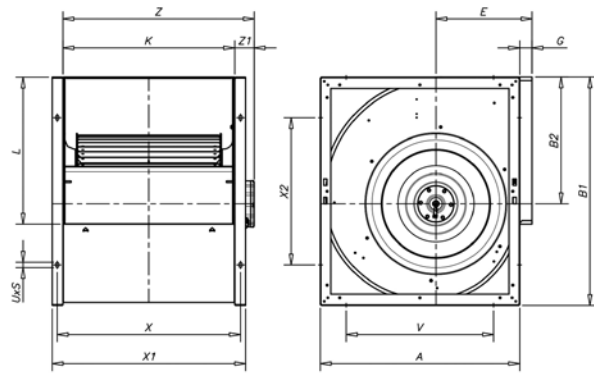

Equiv. Plug.	A	B1	B2	E	E1	G	H	K	L	UxS	V	X	x1	x2	Z1	Z	
CBD-1919	7/7	315	333	189	152	64	-	144	230	208	9x13	225	258	-	-	70	300
CBD-2525	9/9	380	400	218	183	78	-	182	300	263	9x13	275	328	-	-	57	357
CBD-2828	10/10	422	450	246	202	73	-	204	326	292	9x13	315	352	-	-	45	371
CBD-3333	12/12	493	526	290	230	82	-	236	387	345	18x9	390	415	-	-	70	457
CBD-3939	15/15	553	632	352	265	-	30	-	473	408	18x9	406	505	533	406	60	533

Accesorios



INT C2V RM VSD3/A-RFT AET PSB

Curvas Características

Q= Caudal en m³/h, m³/s y cfm.

Pe= Presión estática en mmH²O, Pa e inwg.

1919

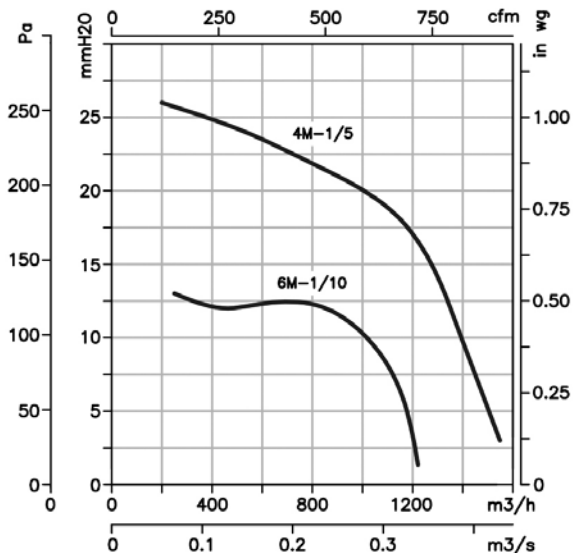

2525

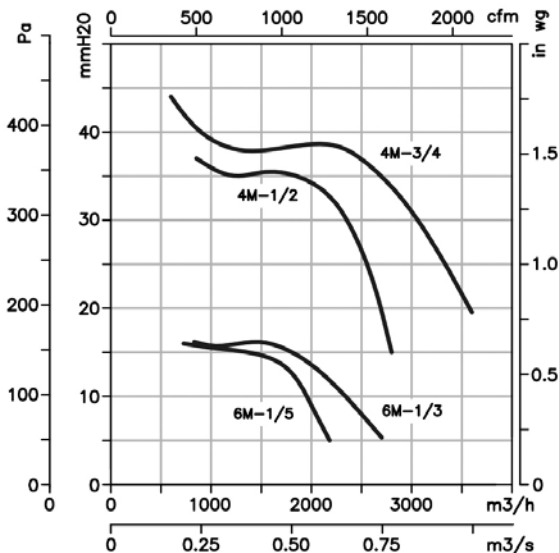

2828

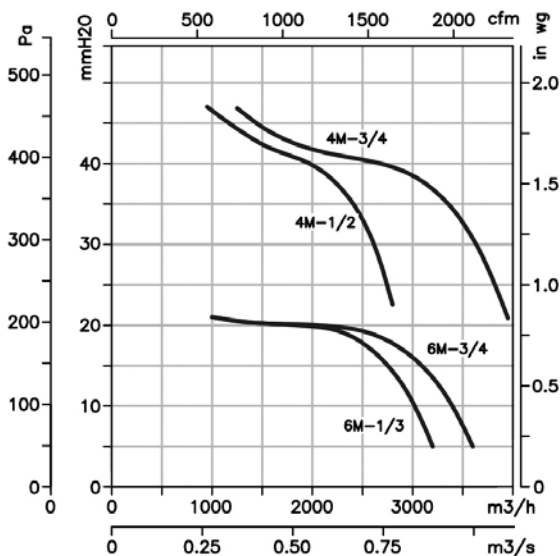

3333/3939

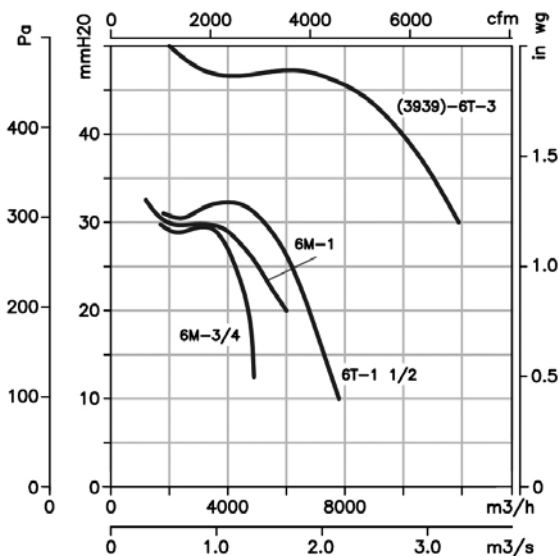

CJBD/ALG

Unidades de ventilación con perfiles de aluminio y chapa de acero galvanizada aisladas acústicamente



Ventilador:

- Ventiladores de doble aspiración de la serie CBD
- Estructura en perfil de aluminio y chapa de acero galvanizada, con aislamiento térmico y acústico
- Turbina con álabes hacia delante, en chapa de acero galvanizada
- Prensaestopas para entrada de cable

Motor:

- Motores cerrados con protector térmico incorporado, clase F, con rodamientos a bolas, protección IP54
- Motor Multitensión, diseño especial válido para: 220/380V 60Hz, 254/440V 60Hz, 265/460V 60Hz, 277/480V 60Hz
- Temperatura máxima del aire a transportar: -20°C + 60°C

Acabado:

- Anticorrosivo en chapa de acero galvanizada y perfil de aluminio

Bajo demanda:

- Con impulsión circular

Código de pedido

CJBD/ALG — 2525 — 6M — 1/3 — 60Hz

- CJBD/ALG:** Con perfil de aluminio y chapa de acero galvanizada
- CJBD/INT:** Unidades de ventilación con interruptor incorporado
- CJBD/C:** Unidades de ventilación con entrada y salida circular
- CJBD/F:** Unidades de ventilación con filtro incorporado
- CJBD/ALS:** Unidades de ventilación con doble pared de aislamiento y chapa prelacada
- CJBD/ALF:** Unidades de ventilación con chapa prelacada y filtro incorporado

Tamaño turbina mm

mm	pulg
1919	7/7
2525	9/9
2828	10/10
3333	12/12
3939	15/15

Número de polos motor

4=1680 r/min. 60 Hz
6=1080 r/min. 60 Hz

T=Trifásico
M=Monofásico

Potencia motor (CV)

Opciones



CJBD/INT



CJBD/C



CJBD/F



CJBD/ALS



CJBD/ALF

Características técnicas

Modelo	Velocidad (r/min)	Intensidad máxima admisible (A) 220-277V 380-480V	Potencia instalada (kW)	Caudal máximo (m³/h)	Nivel sonoro dB(A)	Peso aprox. (Kg)
CJBD/ALG 1919-4M 1/5	1476	1,40	0,15	1520	59	22,5
CJBD/ALG 1919-6M 1/10	984	0,85	0,08	1230	53	22,5
CJBD/ALG 2525-4M 1/2	1584	3,30	0,37	2800	66	31,8
CJBD/ALG 2525-4M 3/4	1572	4,50	0,55	3600	70	32,6
CJBD/ALG 2525-6M 1/5	1020	1,50	0,15	2200	60	30,1
CJBD/ALG 2525-6M 1/3	996	2,20	0,25	2700	62	31,3
CJBD/ALG 2828-4M 1/2	1584	3,30	0,37	2800	65	37,3
CJBD/ALG 2828-4M 3/4	1572	4,50	0,55	3950	70	38,1
CJBD/ALG 2828-6M 1/3	996	2,20	0,25	3200	62	36,8
CJBD/ALG 3333-6T 1 1/2	1080	6,60	3,80	7800	75	53,8
CJBD/ALG 3333-6M 3/4	1020	5,00	0,55	4900	64	52,3
CJBD/ALG 3333-6M 1	1020	6,00	0,75	6000	71	53,3
CJBD/ALG 3939-6T 3	1068	10,90	6,30	11900	75	80,0

Características acústicas

Espectro de potencia sonora Lw(A) en dB(A) por banda de frecuencia en Hz

Modelo	63	125	250	500	1000	2000	4000	8000	Modelo	63	125	250	500	1000	2000	4000	8000
1919-4M 1/5	43	54	58	62	64	63	62	53	2828-4M 3/4	55	66	70	74	76	75	74	65
1919-6M 1/10	38	49	53	57	59	58	57	48	2828-6M 1/3	46	57	61	65	67	66	65	56
2525-4M 1/2	51	62	66	70	72	71	70	61	3333-6T 1 1/2	59	70	74	78	80	79	78	69
2525-4M 3/4	55	66	70	74	76	75	74	65	3333-6M 3/4	48	59	63	67	69	68	67	58
2525-6M 1/5	44	55	59	63	65	64	63	54	3333-6M 1	55	66	70	74	76	75	74	65
2525-6M 1/3	46	57	61	65	67	66	65	56	3939-6T 3	61	72	77	81	83	81	80	71
2828-4M 1/2	50	61	65	69	71	70	69	60									

Dimensiones mm

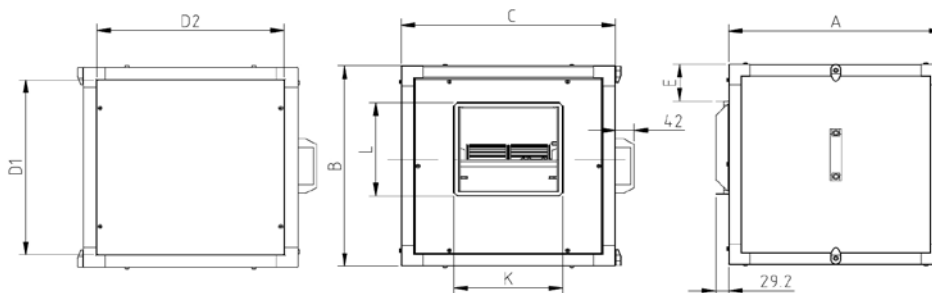

	A	B	C	D1	D2	E	L	K
CJBD/ALG-1919	490	490	490	428	428	91	226	247
CJBD/ALG-2525	550	550	550	488	488	86	279	317
CJBD/ALG-2828	605	605	605	543	543	88	306	343
CJBD/ALG-3333	680	680	680	618	618	84	360	404
CJBD/ALG-3939	855	855	855	793	793	119	423	490

Curvas Características

Q= Caudal en m³/h, m³/s y cfm.

Pe= Presión estática en mmH₂O, Pa e inwg.

1919

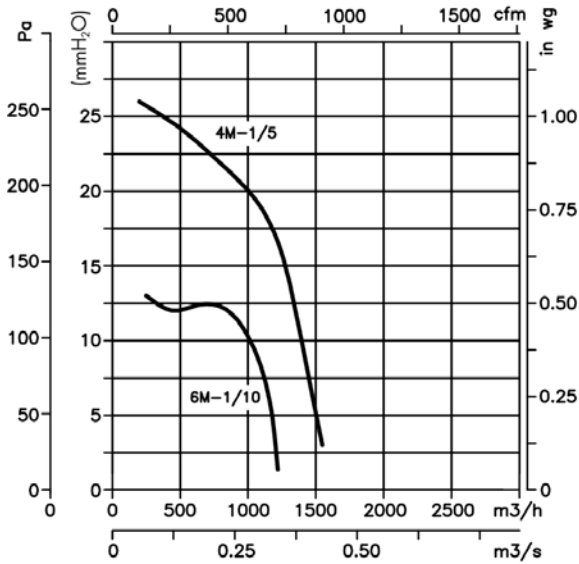

2525

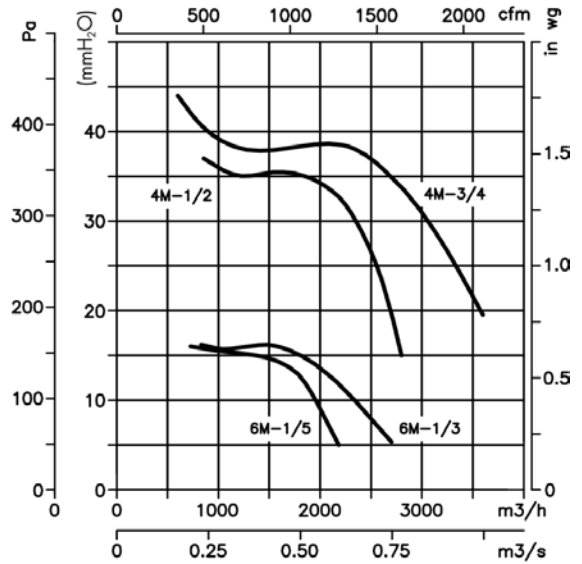

2828

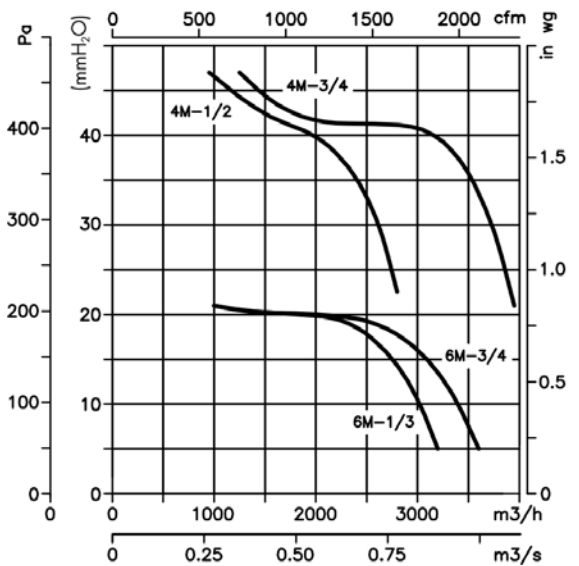

3333/3939

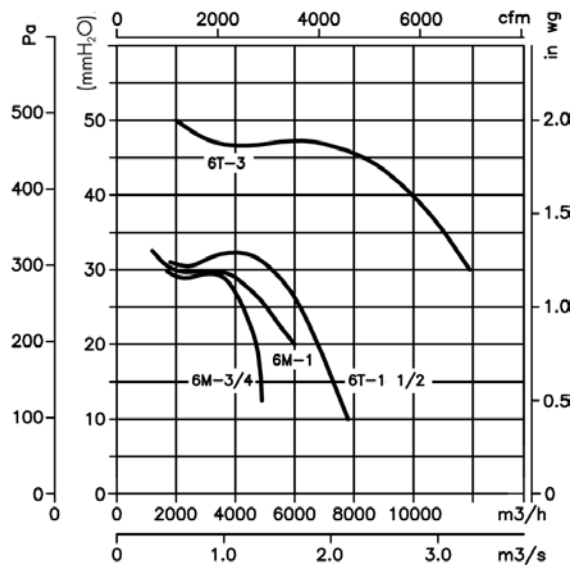

Accesorios



INT C2V RM VSD3/A-RFT AET TEJ VIS

CBX CBXC CBXR CBXT

CBX: Ventiladores centrífugos de doble aspiración a transmisión, con salida de eje por ambos lados y turbina con álabes hacia delante

CBXC: Ventiladores centrífugos de doble aspiración a transmisión, con estructura cúbica de gran rigidez para reforzar la envolvente

CBXR: Ventiladores centrífugos de doble aspiración a transmisión, con estructura reforzada y rodamientos de puente rígido soportados sobre la estructura

CBXT: Ventiladores centrífugos de doble aspiración a transmisión, equipados con motor eléctrico, conjunto de poleas, correas, protectores y turbina con álabes hacia delante



CBX

Ventilador:

- Envolvente en chapa de acero galvanizado
- Turbina con álabes hacia delante, en chapa de acero galvanizado
- CBX y CBXC: Rodamientos soportados con amortiguadores de goma para evitar vibraciones
- CBX: Se suministra con pies soporte PSB

Motor:

- Motores de eficiencia IE3 para potencias iguales o superiores a 0,75kW, excepto monofásicos, 2 velocidades y 8 polos.
- Eje libre con rodamientos a bolas de engrase permanente en ambos lados
- Temperatura máxima del aire a transportar:

CBX, CBXC y CBXT: -20°C.+ 80°C.

CBXR: -20°C.+ 110°C.

Acabado:

- Anticorrosivo en chapa de acero galvanizado

Bajo demanda:

- CBX: Pueden suministrarse el soporte motor y tensor de correas SM



CBXC



CBXR

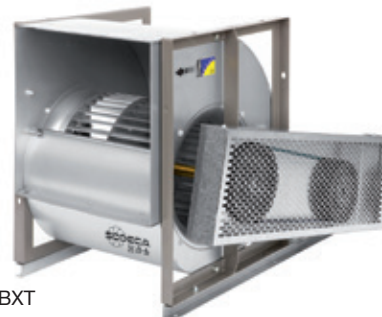

CBXT

Código de pedido

CBXC — **12/12** — **60Hz**

CBX: Ventiladores centrífugos de doble aspiración, con salida de eje libre

Tamaño turbina en pulgadas

CBXC: Ventiladores centrífugos de doble aspiración, estructura cúbica

CBXR: Ventiladores centrífugos de doble aspiración, estructura reforzada

CBXT — **12/12** — **1,5** — **60Hz**

CBXT: Ventiladores centrífugos de doble aspiración a transmisión, equipados con motor eléctrico

Tamaño turbina en pulgadas

Potencia motor (c.v.)

Características técnicas

Modelo	Velocidad máx. (r/min)	Equivalencia Pulgadas	Máx. Potencia instalada (kW)	Caudal máximo (m³/h)	Temperatura del aire (°C)		Peso aprox. (Kg)
					mín.	máx.	
CBX-1919	2500	7/7	1,1	3700	-20	+80	5,0
CBX-2525	1800	9/9	2,2	6200	-20	+80	9,0
CBX-2828	1700	10/10	3,0	7500	-20	+80	10,5
CBX-3333	1400	12/12	3,0	9500	-20	+80	15,5
CBX-3939	1000	15/15	4,0	14400	-20	+80	24,0
CBX-4747	800	18/18	5,5	23500	-20	+80	33,5
CBXC-7/7	2700		1,5	4200	-20	+80	6,0
CBXC-9/9	2100		3,0	7000	-20	+80	11,5
CBXC-10/10	1900		4,0	8400	-20	+80	13,5
CBXC-12/12	1600		4,0	10500	-20	+80	18,5
CBXC-15/15	1100		5,5	16000	-20	+80	27,5
CBXC-18/18	900		7,5	26000	-20	+80	38,5
CBXR-15/15	1200		5,5	16000	-20	80	28,5
CBXR-18/18	1000		7,5	26000	-20	80	40,0
CBXR-20/20	1000		11,0	28000	-20	+110	84,0
CBXR-22/22	900		15,0	34000	-20	+110	94,0
CBXR-25/25	700		15,0	46000	-20	+110	113,0
CBXR-30/28	600		18,5	60000	-20	+110	145,0

Modelo	Velocidad (r/min)	Intensidad máxima admisible (A)			Potencia instalada (kW)	Caudal máximo (m³/h)	Temperatura del aire (°C)		Peso aprox. (Kg)	Versión de Montaje
		220V	380V	660V			mín.	máx.		
CBXT-7/7-0,25	1090	1,1	0,64		0,18	1050	-20	+80	37,0	A
CBXT-7/7-0,33	1220	1,4	0,78		0,25	1100	-20	+80	37,8	A
CBXT-7/7-0,5	1420	1,8	1,05		0,37	1250	-20	+80	39,0	A
CBXT-7/7-0,75	1600	2,5	1,45		0,55	1450	-20	+80	41,0	A
CBXT-7/7-1	1790	3,3	1,90		0,75	1500	-20	+80	42,5	A
CBXT-9/9-0,25	825	1,1	0,64		0,18	1700	-20	+80	48,0	A
CBXT-9/9-0,33	920	1,4	0,78		0,25	1800	-20	+80	50,0	A
CBXT-9/9-0,5	1020	1,8	1,05		0,37	2200	-20	+80	51,5	A
CBXT-9/9-0,75	1050	2,5	1,45		0,55	2900	-20	+80	54,5	A
CBXT-9/9-1	1070	3,3	1,90		0,75	3200	-20	+80	56,0	A
CBXT-9/9-1,5	1260	4,5	2,59		1,10	3750	-20	+80	59,0	A
CBXT-10/10-0,5	845	1,8	1,05		0,37	2950	-20	+80	55,0	A
CBXT-10/10-0,75	845	2,5	1,45		0,55	3800	-20	+80	57,0	A
CBXT-10/10-1	960	3,3	1,90		0,75	4175	-20	+80	58,5	A
CBXT-10/10-1,5	1070	4,5	2,59		1,10	4800	-20	+80	61,3	A
CBXT-10/10-2	1140	6,0	3,45		1,50	5400	-20	+80	64,6	A
CBXT-12/12-0,5	595	1,8	1,05		0,37	4200	-20	+80	69,0	A
CBXT-12/12-0,75	675	2,5	1,45		0,55	4800	-20	+80	71,0	A
CBXT-12/12-1	765	3,3	1,90		0,75	5400	-20	+80	72,4	A
CBXT-12/12-1,5	855	4,5	2,59		1,10	5800	-20	+80	75,3	A
CBXT-12/12-2	965	6,0	3,45		1,50	6500	-20	+80	78,6	A
CBXT-12/12-3	1180	8,4	4,85		2,20	7400	-20	+80	87,0	A
CBXT-15/15-0,75	525	2,5	1,45		0,55	5900	-20	+80	85,0	B
CBXT-15/15-1	595	3,3	1,90		0,75	6500	-20	+80	86,4	B
CBXT-15/15-1,5	635	4,5	2,59		1,10	7500	-20	+80	89,3	B
CBXT-15/15-2	670	6,0	3,45		1,50	8200	-20	+80	92,6	B
CBXT-15/15-3	740	8,4	4,85		2,20	9500	-20	+80	101,0	B
CBXT-15/15-4	805	11,2	6,48		3,00	10600	-20	+80	103,0	B
CBXT-15/15-5,5	965	15,0	8,65		4,00	12000	-20	+80	108,0	B
CBXT-18/18-1,5	480	4,5	2,59		1,10	9000	-20	+80	122,0	B
CBXT-18/18-2	605	6,0	3,45		1,50	9250	-20	+80	125,3	B
CBXT-18/18-3	590	8,4	4,85		2,20	11500	-20	+80	133,7	B
CBXT-18/18-4	640	11,2	6,48		3,00	13200	-20	+80	135,7	B
CBXT-18/18-5,5	675	15,0	8,65		4,00	15000	-20	+80	141,0	B
CBXT-18/18-7,5	760		11,40	6,60	5,50	17000	-20	+80	154,5	B
CBXT-20/20-2	430	6,0	3,45		1,50	11500	-20	+80	222,0	B
CBXT-20/20-3	530	8,4	4,85		2,20	12800	-20	+80	230,5	B
CBXT-20/20-4	575	11,2	6,48		3,00	14200	-20	+80	232,5	B
CBXT-20/20-5,5	635	15,0	8,65		4,00	15500	-20	+80	237,5	B
CBXT-20/20-7,5	675		11,40	6,60	5,50	17500	-20	+80	251,5	B
CBXT-20/20-10	725		14,80	8,50	7,50	20000	-20	+80	266,5	B
CBXT-22/22-2	385	6,0	3,45		1,50	14000	-20	+80	250,0	B
CBXT-22/22-3	475	8,4	4,85		2,20	15000	-20	+80	257,0	B

Características técnicas

Modelo	Velocidad (r/min)	Intensidad máxima admisible (A)			Potencia instalada (kW)	Caudal máximo (m ³ /h)	Temperatura del aire (°C)		Peso aprox. (Kg)	Versión de Montaje
		220V	380V	660V			mín.	máx.		
CBXT-22/22-4	515	11,2	6,48		3,00	17000	-20	+80	261,0	B
CBXT-22/22-5,5	570	15,0	8,65		4,00	19000	-20	+80	265,0	B
CBXT-22/22-7,5	605		11,40	6,60	5,50	21500	-20	+80	279,0	B
CBXT-22/22-10	725		14,80	8,50	7,50	22000	-20	+80	290,0	B
CBXT-22/22-15	765		21,00	12,10	11,00	27000	-20	+80	316,0	B
CBXT-25/25-3	375	8,4	4,85		2,20	17000	-20	+80	297,0	B
CBXT-25/25-4	405	11,2	6,48		3,00	20500	-20	+80	299,0	B
CBXT-25/25-5,5	450	15,0	8,65		4,00	22000	-20	+80	304,0	B
CBXT-25/25-7,5	485		11,40	6,60	5,50	24500	-20	+80	318,0	B
CBXT-25/25-10	545		14,80	8,50	7,50	28000	-20	+80	329,0	B
CBXT-25/25-15	610		21,00	12,10	11,00	32000	-20	+80	349,0	B
CBXT-30/28-3	330	8,4	4,85		2,20	20000	-20	+80	380,0	B
CBXT-30/28-4	360	11,2	6,48		3,00	22000	-20	+80	382,0	B
CBXT-30/28-5,5	380	15,0	8,65		4,00	25000	-20	+80	387,0	B
CBXT-30/28-7,5	380		11,40	6,60	5,50	31500	-20	+80	402,0	B
CBXT-30/28-10	410		14,80	8,50	7,50	36000	-20	+80	415,0	B
CBXT-30/28-15	430		21,00	12,10	11,00	42000	-20	+80	426,0	B
CBXT-30/28-20	480		28,50	16,50	15,00	48000	-20	+80	449,0	B

Dimensiones mm

CBX

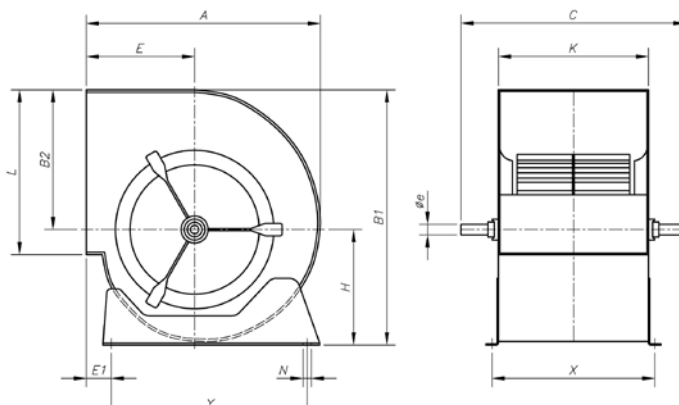

Modelo	Equiv. pulg.	A	B1	B2	C	E	E1	H	K	L	N	øe	X	Y
CBX-1919	7/7	316	333	189	360	152	64	144	230	208	9x13	20	258	225
CBX-2525	9/9	380	400	218	430	183	78	182	300	263	9x13	20	328	275
CBX-2828	10/10	422	450	246	470	202	73	204	326	292	9x17	20	355	315
CBX-3333	12/12	493	526	290	560	230	82	236	387	345	9x17	25	415	390
CBX-3939	15/15	579	621	348	650	265	92	273	473	404	9x17	25	500	455
CBX-4747	18/18	686	746	415	750	323	82	331	540	482	9x17	25	568	575

CBXC

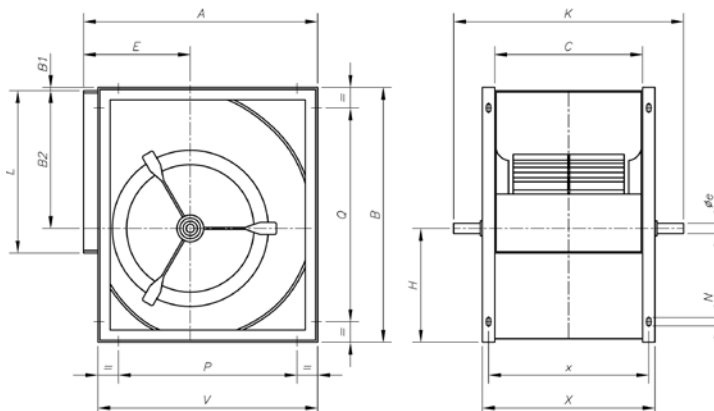

Modelo	A	B	B2	C	E	øe	H	K	L	N	P	Q	V	X	x
CBXC-7/7	322	342	189	230	152	20	153	360	208	9x17	148	175	292	290	262
CBXC-9/9	388	402	218	300	183	20	184	430	263	9x17	214	214	358	360	332
CBXC-10/10	428	450	246	326	202	20	204	470	292	9x17	254	254	398	386	358
CBXC-12/12	498	532	290	387	230	25	242	560	345	9x17	324	324	468	447	419
CBXC-15/15	583	632	348	473	265	25	284	650	404	9x17	406	406	553	533	505
CBXC-18/18	694	756	415	540	323	25	341	750	482	9x17	520	608	664	600	572

Dimensiones mm

CBXR

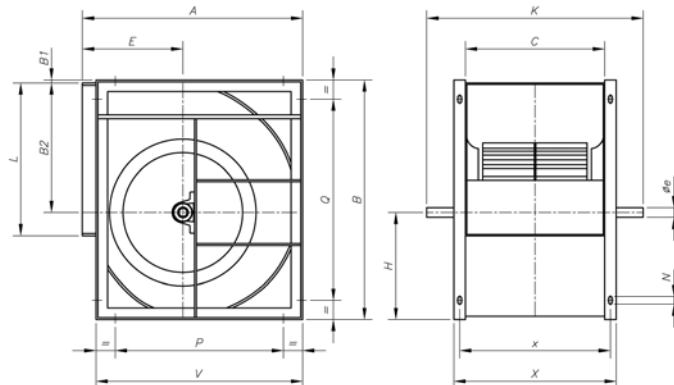

Modelo	A	B	B1	B2	C	E	øe	H	K	L	N	P	Q	V	X	x
CBXR-15/15	583	632	-	348	473	265	25	284	730	404	9x17	406	406	553	533	505
CBXR-18/18	694	756	-	415	540	323	25	341	800	482	9x17	520	608	664	600	572
CBXR-20/20	843	963	35	523	603	375	35	405	923	603	13x25	646	811	798	683	643
CBXR-22/22	913	1046	35	569	656	400	35	442	976	693	13x25	716	894	868	736	696
CBXR-25/25	998	1161	35	642	765	423	35	484	1085	793	13x25	801	1009	953	845	805
CBXR-30/28	1206	1400	35	776	888	515	40	589	1208	933	13x25	1009	1248	1161	968	928

CBXT Montaje A

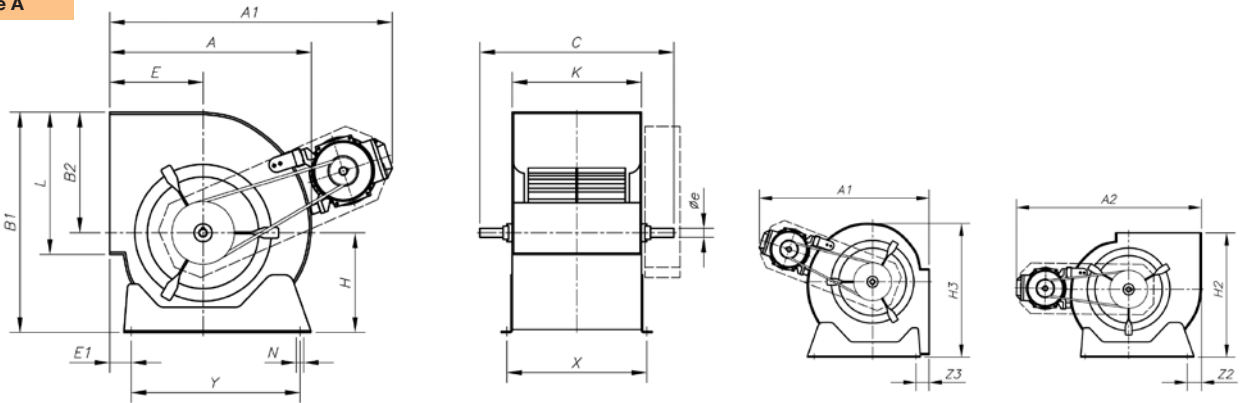

Modelo	A	A1	A2	B1	B2	C	E	E1	øe	H	H2	H3	K	L	N	X	Y	Z2	Z3
CBXT-7/7-0'25	316	430	475	333	189	360	152	64	20	144	320	341	230	208	9x13	258	225	44	36
CBXT-7/7-0'33	316	450	495	333	189	360	152	64	20	144	320	341	230	208	9x13	258	225	44	36
CBXT-7/7-0'5	316	450	495	333	189	360	152	64	20	144	320	341	230	208	9x13	258	225	44	36
CBXT-7/7-0'75	316	470	515	333	189	360	152	64	20	144	320	341	230	208	9x13	258	225	44	36
CBXT-7/7-1	316	470	515	333	189	360	152	64	20	144	320	341	230	208	9x13	258	225	44	36
CBXT-9/9-0'25	380	490	535	400	218	430	183	78	20	182	385	395	300	263	9x13	328	275	50	57
CBXT-9/9-0'33	380	520	565	400	218	430	183	78	20	182	385	395	300	263	9x13	328	275	50	57
CBXT-9/9-0'5	380	520	565	400	218	430	183	78	20	182	385	395	300	263	9x13	328	275	50	57
CBXT-9/9-0'75	380	540	585	400	218	430	183	78	20	182	385	395	300	263	9x13	328	275	50	57
CBXT-9/9-1	380	540	585	400	218	430	183	78	20	182	385	395	300	263	9x13	328	275	50	57
CBXT-9/9-1'5	380	590	605	400	218	430	183	78	20	182	385	395	300	263	9x13	328	275	50	57
CBXT-10/10-0'5	422	570	615	450	246	470	202	73	20	204	443	470	326	292	9x17	355	315	50	50
CBXT-10/10-0'75	422	590	635	450	246	470	202	73	20	204	443	470	326	292	9x17	355	315	50	50
CBXT-10/10-1	422	590	635	450	246	470	202	73	20	204	443	470	326	292	9x17	355	315	50	50
CBXT-10/10-1'5	422	610	655	450	246	470	202	73	20	204	443	470	326	292	9x17	355	315	50	50
CBXT-10/10-2	422	610	655	450	246	470	202	73	20	204	443	470	326	292	9x17	355	315	50	50
CBXT-12/12-0'5	493	645	690	526	290	560	230	82	25	236	498	555	387	345	9x17	415	390	35	70
CBXT-12/12-0'75	493	665	710	526	290	560	230	82	25	236	498	555	387	345	9x17	415	390	35	70
CBXT-12/12-1	493	665	710	526	290	560	230	82	25	236	498	555	387	345	9x17	415	390	35	70
CBXT-12/12-1'5	493	680	725	526	290	560	230	82	25	236	498	555	387	345	9x17	415	390	35	70
CBXT-12/12-2	493	680	725	526	290	560	230	82	25	236	498	555	387	345	9x17	415	390	35	70
CBXT-12/12-3	493	700	745	526	290	560	230	82	25	236	498	555	387	345	9x17	415	390	35	70

Dimensiones mm

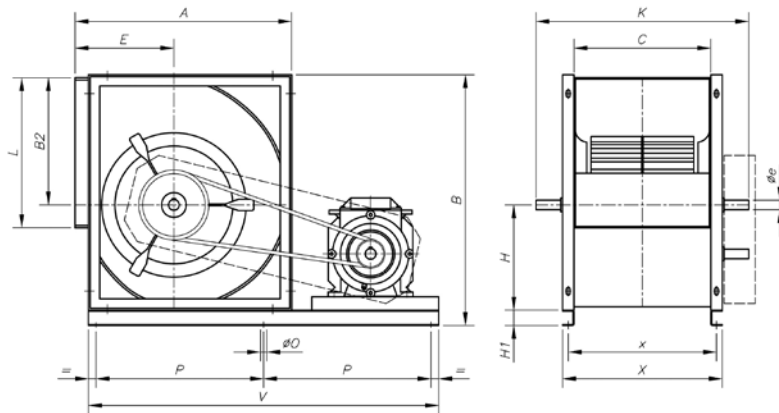
CBXT
Montaje B

Modelo	A	B	B2	C	E	øe	H	H1	K	L	ø0	P	V	x	X
CBXT-15/15	583	672	348	473	265	25	284	40	650	404	12	415,5	895	505	533
CBXT-18/18	694	796	415	540	323	25	341	40	750	482	12	515,5	1115	572	600

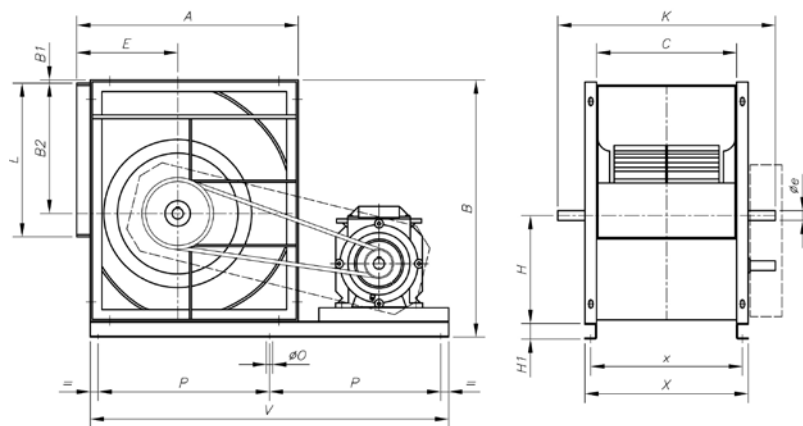

Modelo	A	B	B1	B2	C	E	øe	H	H1	K	L	ø0	P	V	x	X
CBXT-20/20	843	1023	35	523	603	375	35	405	60	923	603	12	617,5	1315	643	683
CBXT-22/22	913	1106	35	569	656	400	35	442	60	976	693	12	657,5	1395	696	736
CBXT-25/25	998	1221	35	642	765	423	35	484	60	1085	793	12	474,5	1575	805	845
CBXT-30/28	1206	1460	35	776	888	515	40	589	60	1208	933	12	817,5	1715	928	968

Accesorios



INT

C2V

RM

VSD3/A-RFT

AET

PSB

SM

Curvas Características

Q= Caudal en m³/h, m³/s y cfm.

Pe= Presión estática en mmH₂O, Pa e inwg.

7/7 (1919)

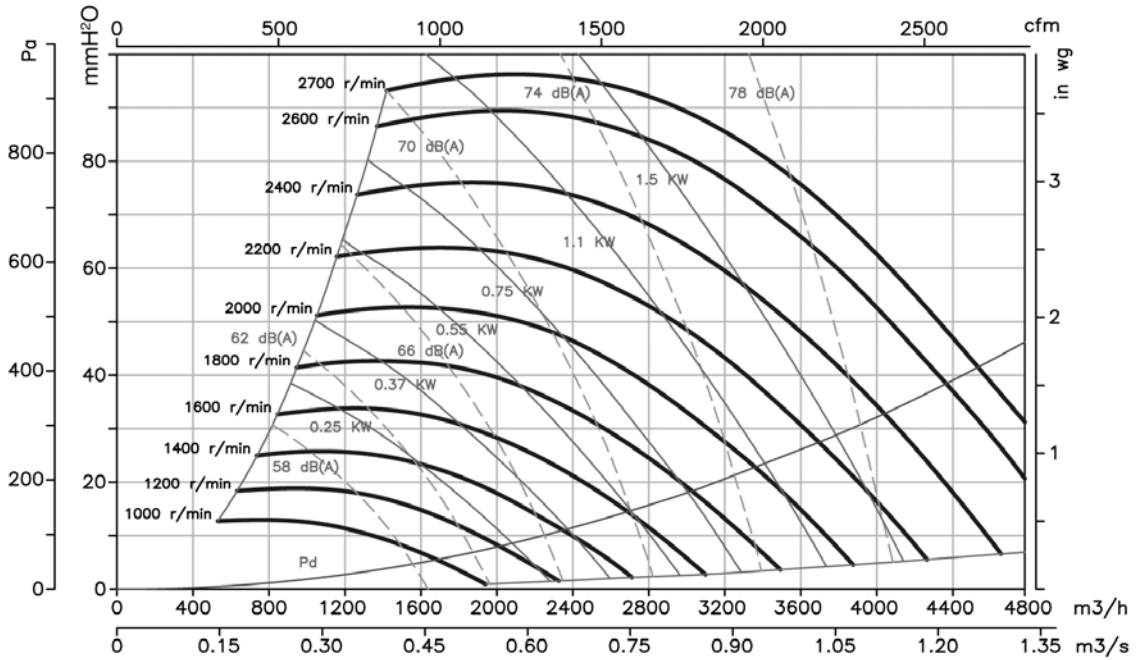

9/9 (2525)

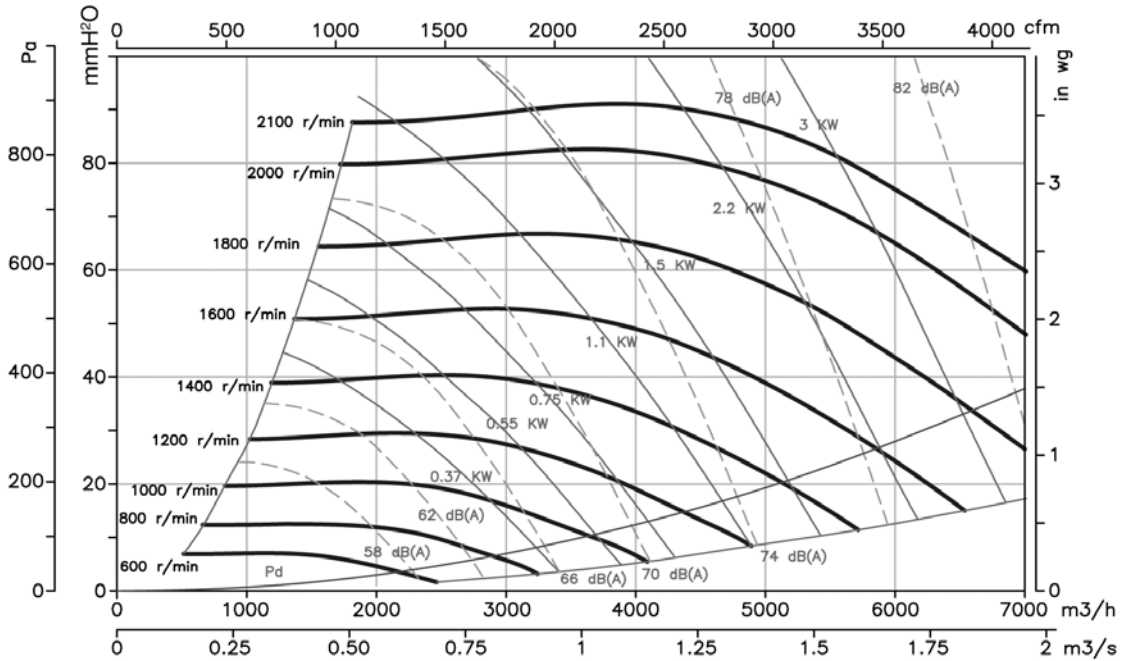

Curvas Características

Q= Caudal en m³/h, m³/s y cfm.

Pe= Presión estática en mmH₂O, Pa e inwg.

10/10 (2828)

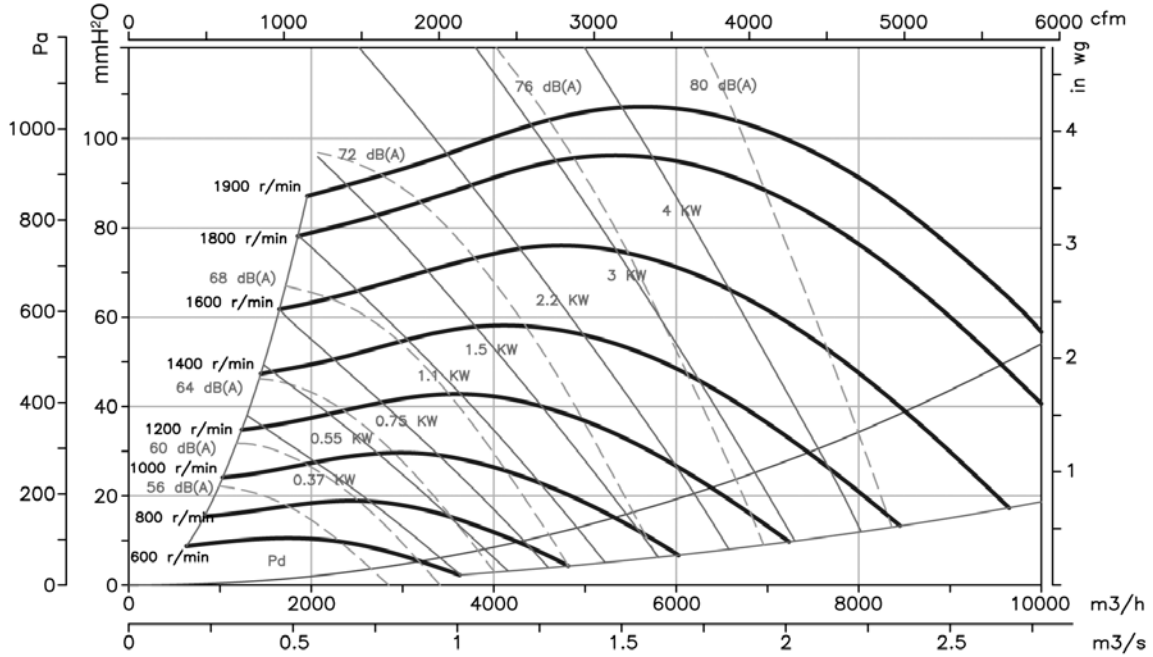

12/12 (3333)

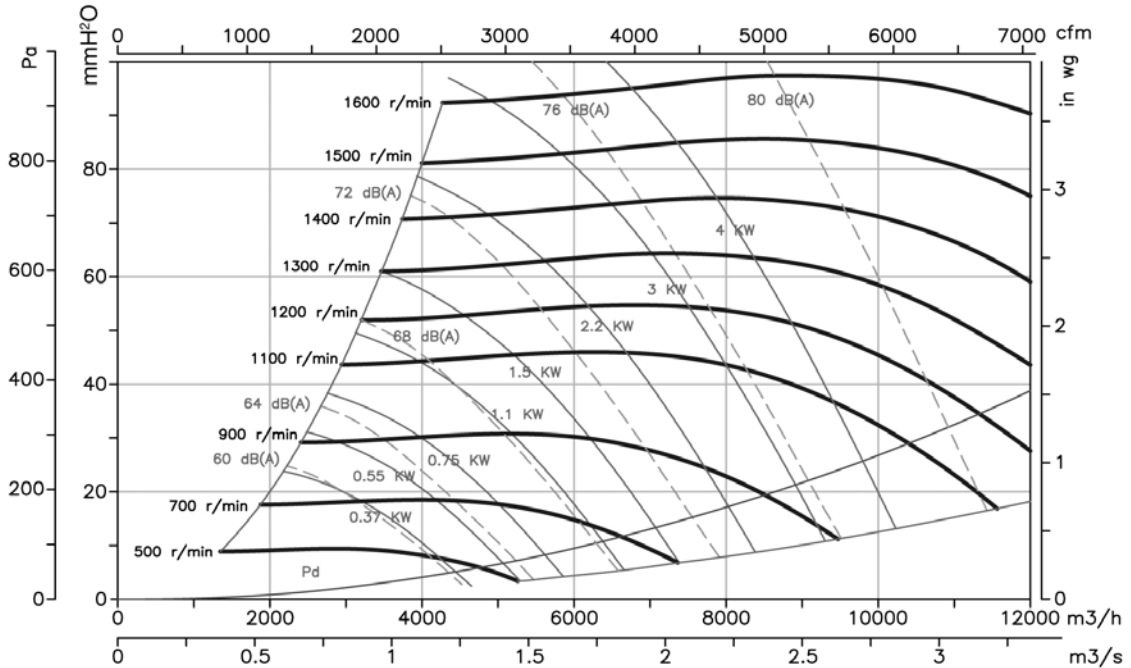

Curvas Características

Q= Caudal en m³/h, m³/s y cfm.

Pe= Presión estática en mmH₂O, Pa e inwg.

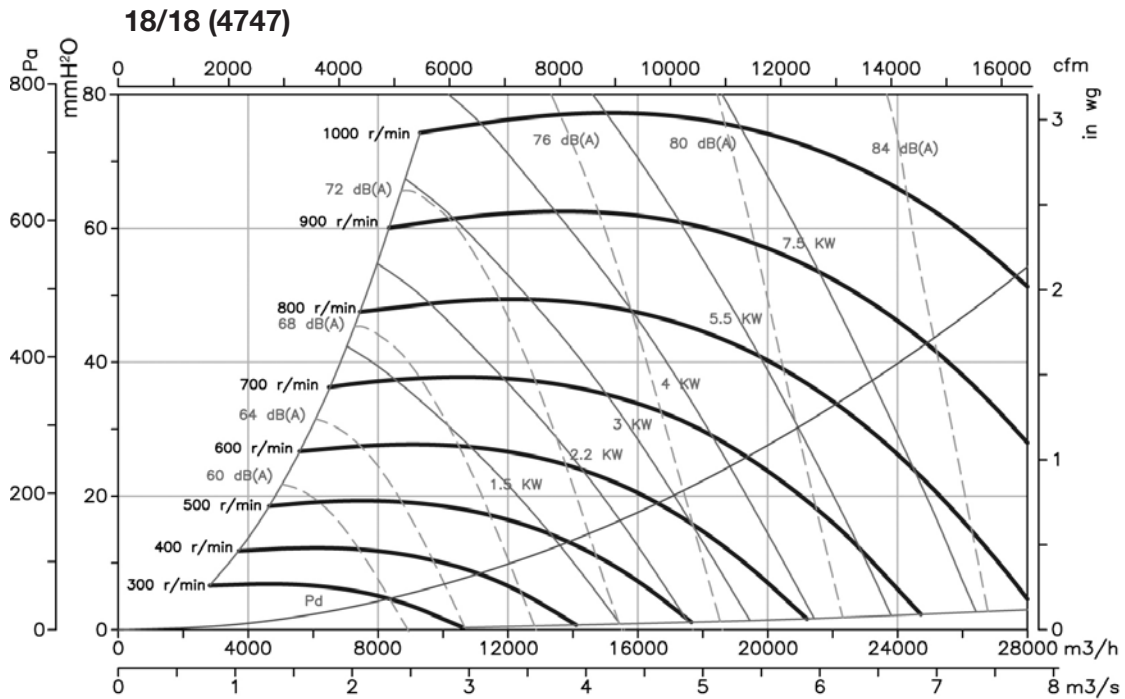
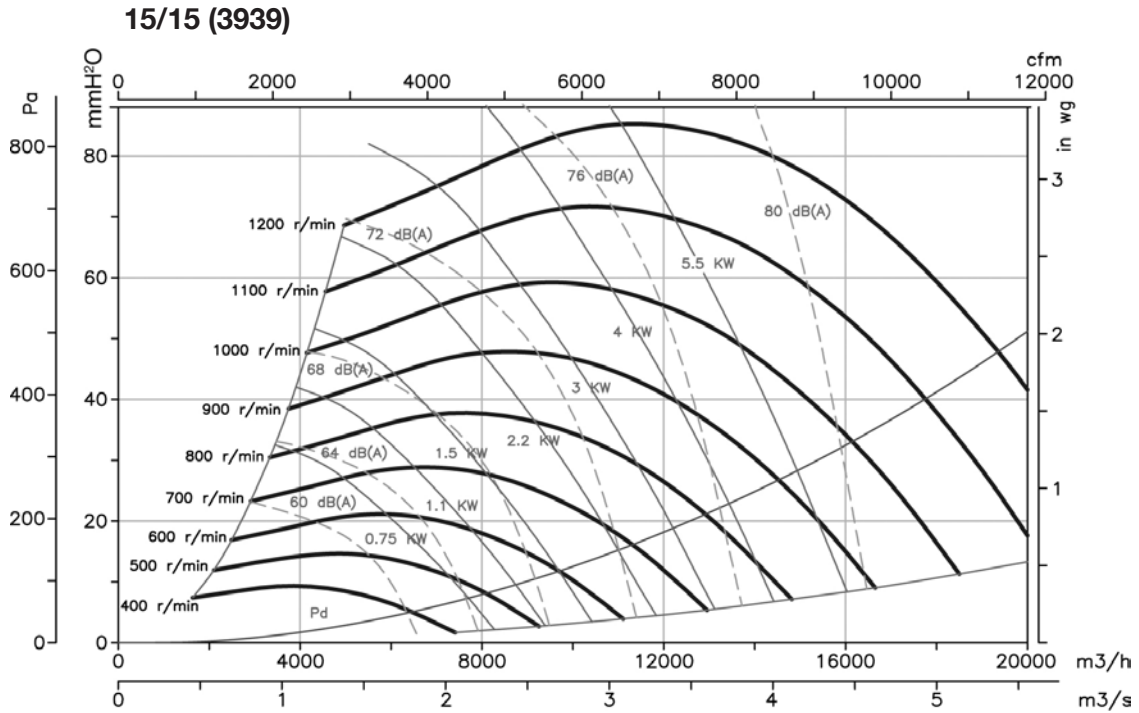

Curvas Características

Q= Caudal en m³/h, m³/s y cfm.

Pe= Presión estática en mmH₂O, Pa e inwg.

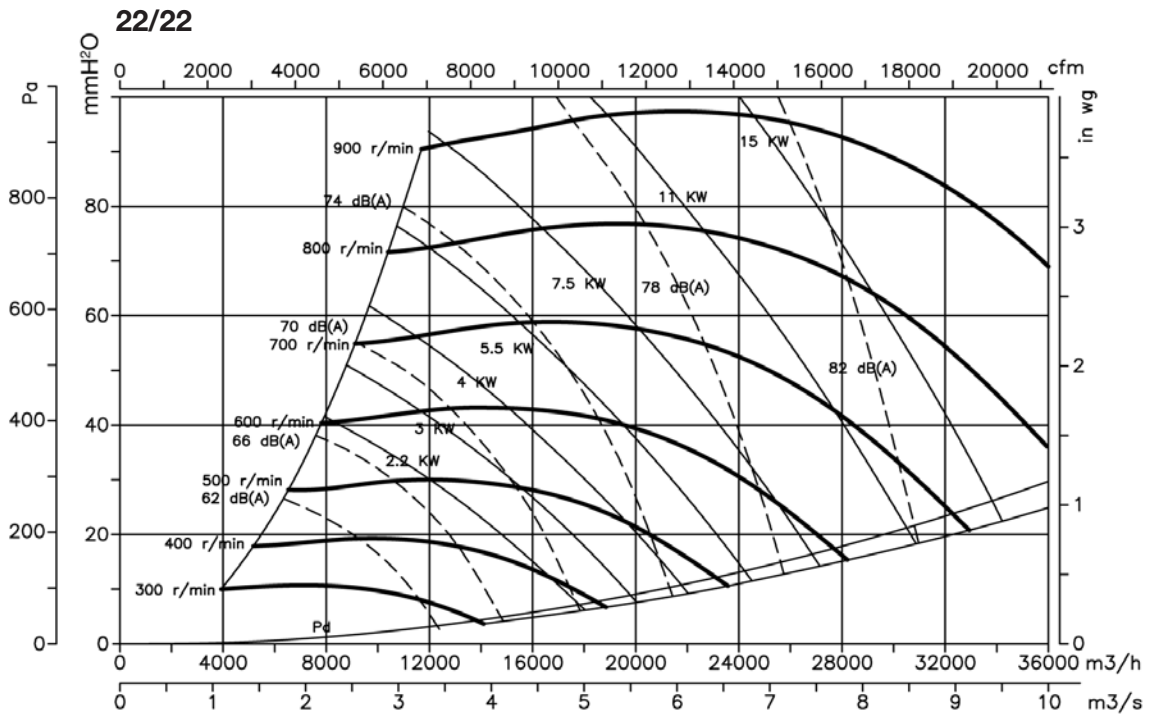
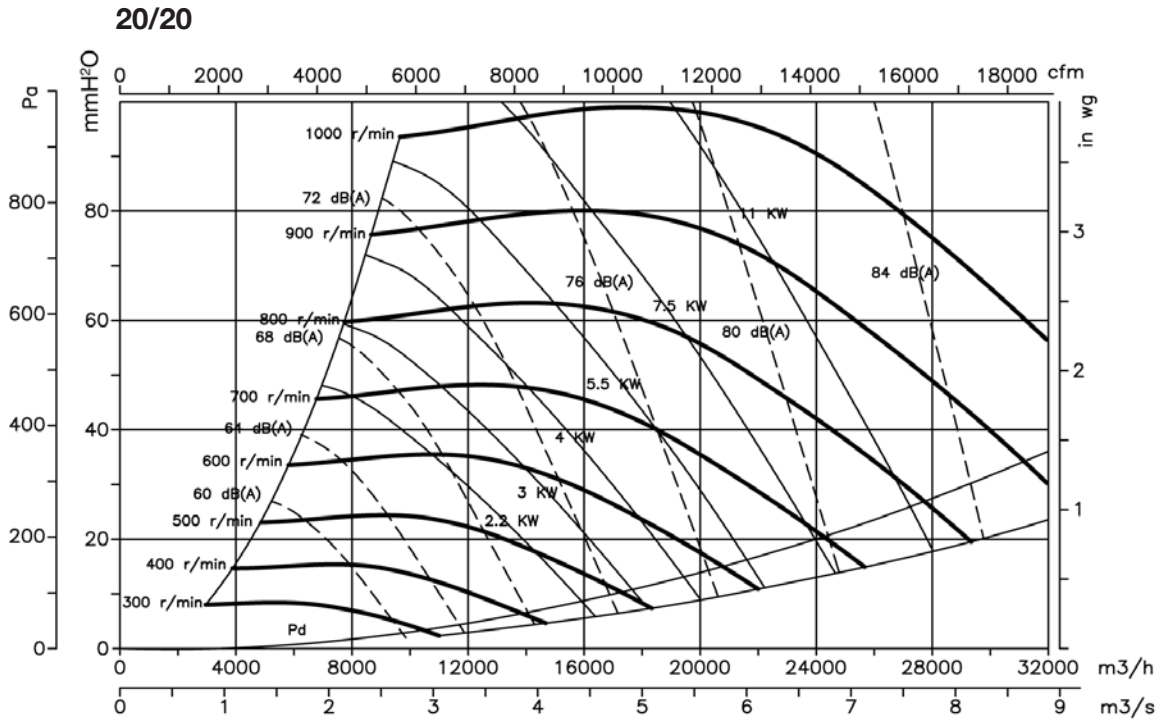

Curvas Características

Q= Caudal en m³/h, m³/s y cfm.

Pe= Presión estática en mmH₂O, Pa e inwg.

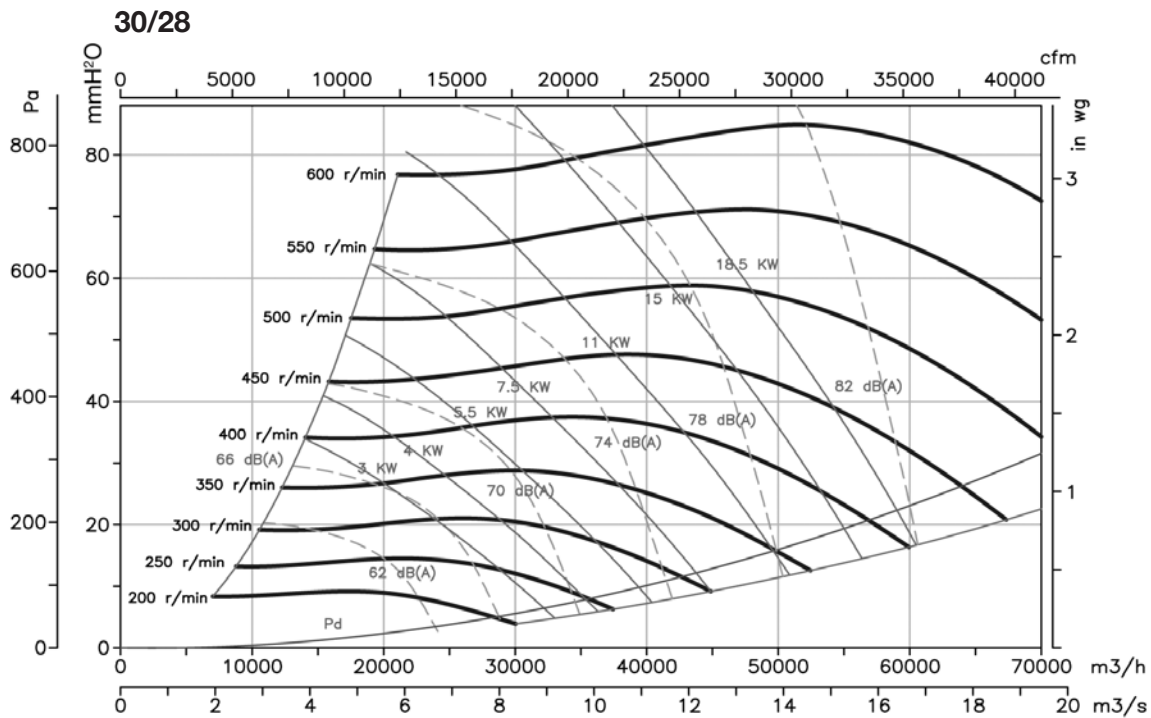
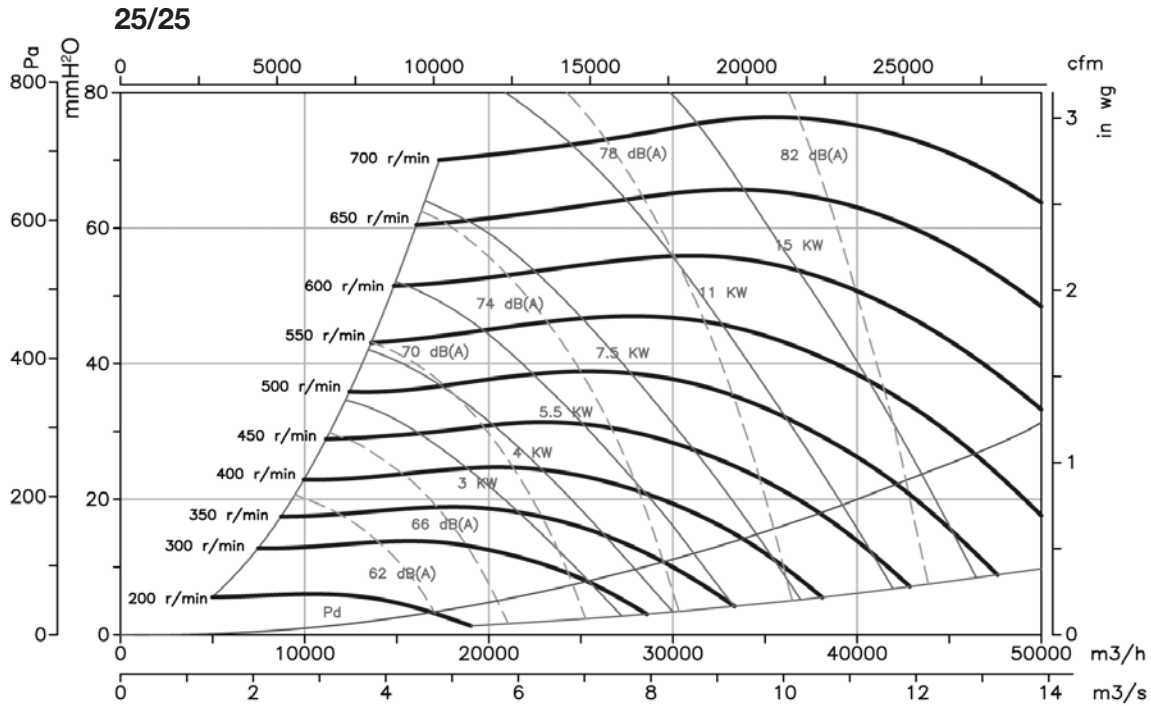

CJBX/ALG

Unidades de ventilación a transmisión con perfilería de aluminio y chapa de acero galvanizada, aisladas acústicamente



Ventilador:

- Unidades de ventilación equipados con ventiladores de doble aspiración de las series CBX, CBXC, CBXR
- Estructura en perfilería de aluminio y chapa de acero galvanizada, con aislamiento térmico y acústico
- Turbina con álabes hacia delante, en chapa de acero galvanizado
- Prensaestopas para entrada de cable

Motor:

- Motores de eficiencia IE3 para potencias iguales o superiores a 0,75kW, excepto monofásicos, 2 velocidades y 8 polos.
- Motores clase F, con rodamientos a bolas, protección IP55
- Motor Multitensión, diseño especial válido para: 220/380V 60Hz, 254/440V 60Hz, 265/460V 60Hz, 277/480V 60Hz
- Temperatura máxima del aire a transportar: -20°C + 60°C

Acabado:

- Anticorrosivo en chapa de acero galvanizada y perfilería de aluminio

Bajo demanda:

- Con impulsión circular



Turbina de alta calidad y gran robustez, equilibrada dinámicamente según ISO 21940-11

Código de pedido



Opciones



CJBX/F



CJBX/ALS



CJBX/ALF

Características técnicas

Modelo	Velocidad (r/min)	Intensidad máx admisible (A)		Potencia instalada (kW)	Caudal máximo (m³/h)	Nivel presión sonora dB(A)	Peso aprox. (Kg)	Tipo Montaje
		220-277V	380-480V					
CJBX/ALG 7/7-0,25	1090	1,23	0,71	0,18	1050	48	37,0	A
CJBX/ALG 7/7-0,33	1220	1,66	0,96	0,25	1100	50	37,8	A
CJBX/ALG 7/7-0,5	1420	2,02	1,17	0,37	1250	53	39,0	A
CJBX/ALG 7/7-0,75	1600	2,92	1,69	0,55	1450	56	41,0	A
CJBX/ALG 7/7-1	1790	3,10	1,79	0,75	1500	58	42,5	A
CJBX/ALG 9/9-0,25	825	1,23	0,71	0,18	1700	45	48,0	A
CJBX/ALG 9/9-0,33	920	1,66	0,96	0,25	1800	48	50,0	A
CJBX/ALG 9/9-0,5	1020	2,02	1,17	0,37	2200	51	51,5	A
CJBX/ALG 9/9-0,75	1050	2,92	1,69	0,55	2900	55	54,5	A
CJBX/ALG 9/9-1	1070	3,10	1,79	0,75	3200	56	56,0	A
CJBX/ALG 9/9-1,5	1260	4,03	2,32	1,10	3750	60	59,0	A
CJBX/ALG 10/10-0,5	845	2,02	1,17	0,37	2950	52	55,0	A
CJBX/ALG 10/10-0,75	845	2,92	1,69	0,55	3800	56	57,0	A
CJBX/ALG 10/10-1	960	3,10	1,79	0,75	4175	58	58,5	A
CJBX/ALG 10/10-1,5	1070	4,03	2,32	1,10	4800	61	61,3	A
CJBX/ALG 10/10-2	1140	5,96	3,44	1,50	5400	63	64,6	A
CJBX/ALG 12/12-0,5	595	2,02	1,17	0,37	4200	52	69,0	A
CJBX/ALG 12/12-0,75	675	2,92	1,69	0,55	4800	54	71,0	A
CJBX/ALG 12/12-1	765	3,10	1,79	0,75	5400	57	72,4	A
CJBX/ALG 12/12-1,5	855	4,03	2,32	1,10	5800	59	75,3	A
CJBX/ALG 12/12-2	965	5,96	3,44	1,50	6500	62	78,6	A
CJBX/ALG 12/12-3	1180	8,36	4,83	2,20	7400	65	87,0	A
CJBX/ALG 15/15-0,75	525	2,92	1,69	0,55	5900	49	85,0	B
CJBX/ALG 15/15-1	595	3,10	1,79	0,75	6500	52	86,4	B
CJBX/ALG 15/15-1,5	635	4,03	2,32	1,10	7500	54	89,3	B
CJBX/ALG 15/15-2	670	5,96	3,44	1,50	8200	56	92,6	B
CJBX/ALG 15/15-3	740	8,36	4,83	2,20	9500	59	101,0	B
CJBX/ALG 15/15-4	805	10,96	6,33	3,00	10600	61	103,0	B
CJBX/ALG 15/15-5,5	965	14,10	8,12	4,00	12000	63	108,0	B
CJBX/ALG 18/18-1,5	480	4,03	2,32	1,10	9000	48	122,0	B
CJBX/ALG 18/18-2	605	5,96	3,44	1,50	9250	51	125,3	B
CJBX/ALG 18/18-3	590	8,36	4,83	2,20	11500	54	133,7	B
CJBX/ALG 18/18-4	640	10,96	6,33	3,00	13200	56	135,7	B
CJBX/ALG 18/18-5,5	675	14,10	8,12	4,00	15000	58	141,0	B
CJBX/ALG 18/18-7,5	760	11,60	5,50	5,50	17000	60	154,5	C
CJBX/ALG 20/20-2	430	5,96	3,44	1,50	11500	56	222,0	C
CJBX/ALG 20/20-3	530	8,36	4,83	2,20	12800	57	230,5	C
CJBX/ALG 20/20-4	575	10,96	6,33	3,00	14200	58	232,5	C
CJBX/ALG 20/20-5,5	635	14,10	8,12	4,00	15500	61	237,5	C
CJBX/ALG 20/20-7,5	675	11,60	5,50	5,50	17500	63	251,5	C
CJBX/ALG 20/20-10 IE3	725	13,90	7,50	7,50	20000	65	282,5	C
CJBX/ALG 22/22-2	385	5,96	3,44	1,50	14000	50	250,0	C
CJBX/ALG 22/22-3	475	8,36	4,83	2,20	15000	54	257,0	C
CJBX/ALG 22/22-4	515	10,96	6,33	3,00	17000	55	261,0	C
CJBX/ALG 22/22-5,5	570	14,10	8,12	4,00	19000	57	265,0	C
CJBX/ALG 22/22-7,5	605	11,60	5,50	5,50	21500	60	279,0	C
CJBX/ALG 22/22-10 IE3	725	13,90	7,50	7,50	22000	63	306,0	C
CJBX/ALG 22/22-15 IE3	765	20,90	11,00	11,00	27000	65	341,0	C
CJBX/ALG 25/25-3	375	8,36	4,83	2,20	17000	53	297,0	C
CJBX/ALG 25/25-4	405	10,96	6,33	3,00	20500	55	299,0	C
CJBX/ALG 25/25-5,5	450	14,10	8,12	4,00	22000	57	304,0	C
CJBX/ALG 25/25-7,5	485	11,60	5,50	5,50	24500	59	318,0	C
CJBX/ALG 25/25-10 IE3	545	13,90	7,50	7,50	28000	61	345,0	C
CJBX/ALG 25/25-15 IE3	610	20,90	11,00	11,00	32000	64	374,0	C
CJBX/ALG 30/28-3	330	8,36	4,83	2,20	20000	54	380,0	C
CJBX/ALG 30/28-4	360	10,96	6,33	3,00	22000	56	382,0	C
CJBX/ALG 30/28-5,5	380	14,10	8,12	4,00	25000	59	387,0	C
CJBX/ALG 30/28-7,5	380	11,60	5,50	5,50	31500	60	402,0	C
CJBX/ALG 30/28-10 IE3	410	13,90	7,50	7,50	36000	63	431,0	C
CJBX/ALG 30/28-15 IE3	430	20,90	11,00	11,00	42000	65	451,0	C
CJBX/ALG 30/28-20 IE3	480	27,90	15,00	15,00	48000	68	466,0	C

Dimensiones mm

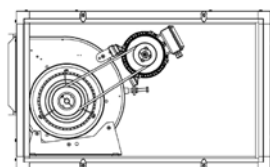
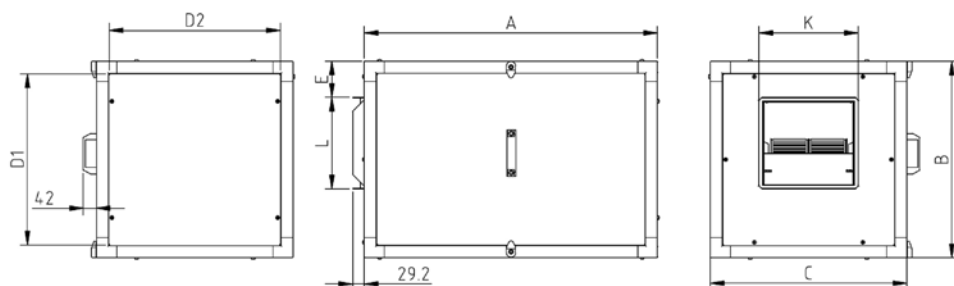

Montaje A

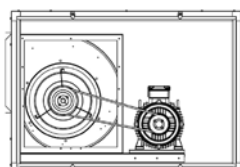

Montaje B y C

	A	B	C	D1	D2	E	L	K	Tipo de Montaje
CJBX/ALG-7/7	830	490	490	428	428	91	226	247	A
CJBX/ALG-9/9	920	550	500	488	488	86	279	317	A
CJBX/ALG-10/10	970	605	605	543	543	88	306	343	A
CJBX/ALG-12/12	1050	680	680	618	618	84	360	404	A
CJBX/ALG-15/15	1220	855	855	793	793	119	423	490	B
CJBX/ALG-18/18	1356	1000	1000	938	938	137	498	554	B-C
CJBX/ALG-20/20	1445	1175	1175	1115	1040	136	615	615	C
CJBX/ALG-22/22	1600	1250	1250	1190	1190	124	705	668	C
CJBX/ALG-25/25	1550	1450	1450	1390	1390	198	805	778	C
CJBX/ALG-30/28	1900	1700	1700	1640	1640	224	945	900	C

Impulsión vertical

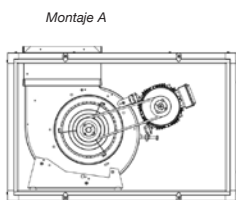
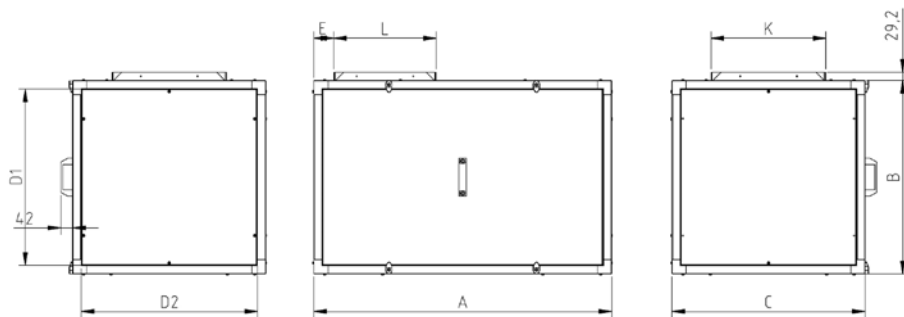

Montaje A

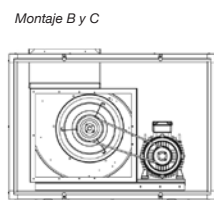

Montaje B y C

	A	B	C	D1	D2	E	L	K	Tipo de Montaje
CJBX/ALG-7/7	830	490	490	428	428	63	226	247	A
CJBX/ALG-9/9	920	550	500	488	488	85	279	317	A
CJBX/ALG-10/10	970	605	605	543	543	87	306	343	A
CJBX/ALG-12/12	1050	680	680	618	618	69	360	404	A
CJBX/ALG-15/15	1220	855	855	793	793	115	423	490	B
CJBX/ALG-18/18	1356	1000	1000	938	938	80	498	554	B-C
CJBX/ALG-20/20	1400	1170	1250	1090	1170	349,5	620	618	C
CJBX/ALG-22/22	1480	1230	1300	1150	1220	342,5	711	681	C
CJBX/ALG-25/25	1600	1350	1500	1270	1420	366,5	810	781	C
CJBX/ALG-30/28	1850	1600	1700	1520	1620	459,5	949	906	C

Curvas Características

Q= Caudal en m³/h, m³/s y cfm

Pe= Presión estática en mmH₂O, Pa e in wg.

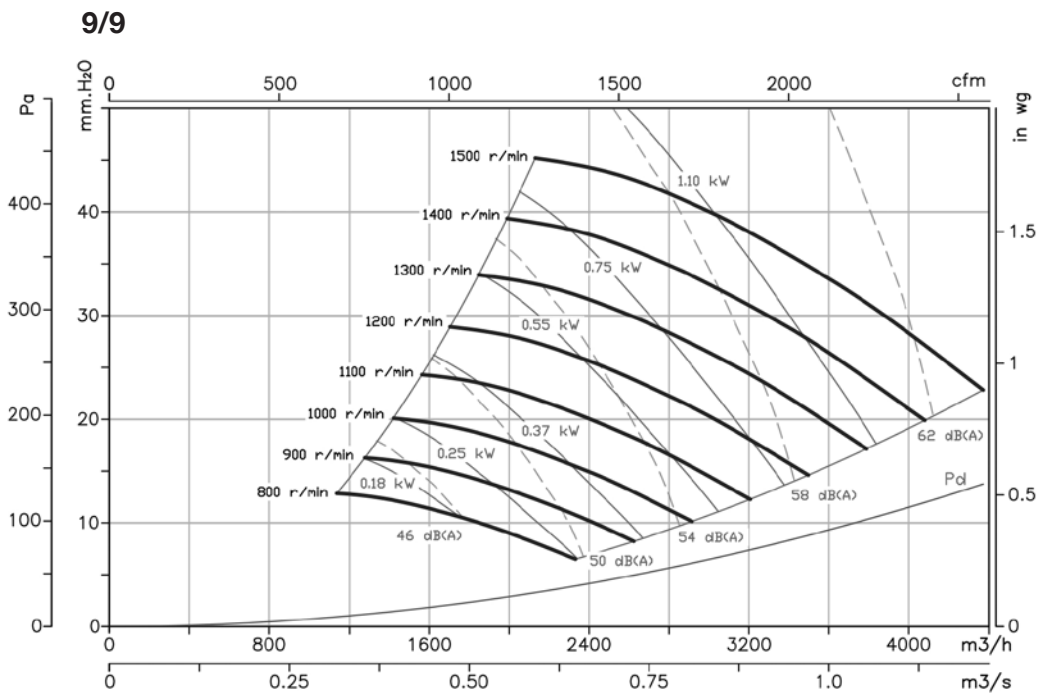
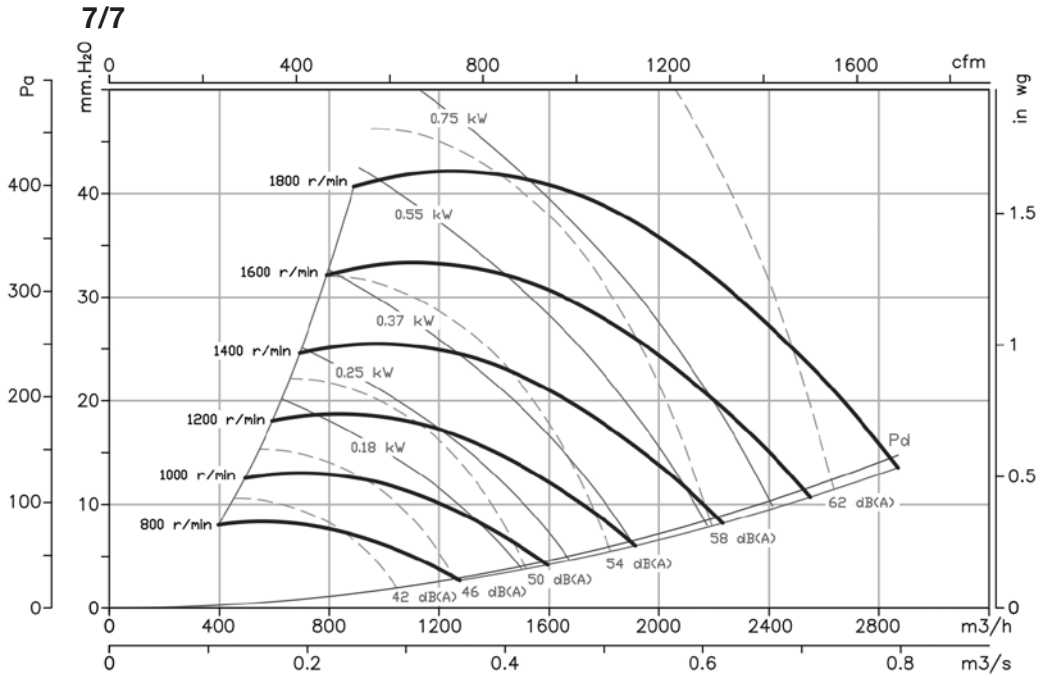

Curvas Características

Q= Caudal en m³/h, m³/s y cfm

Pe= Presión estática en mmH₂O, Pa e in wg.

10/10

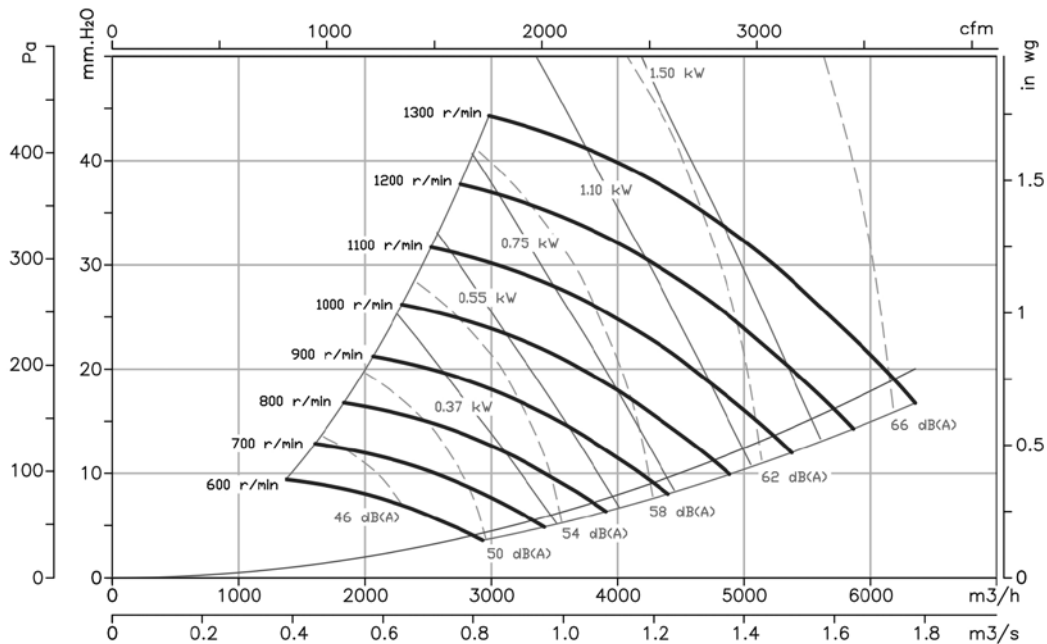

12/12

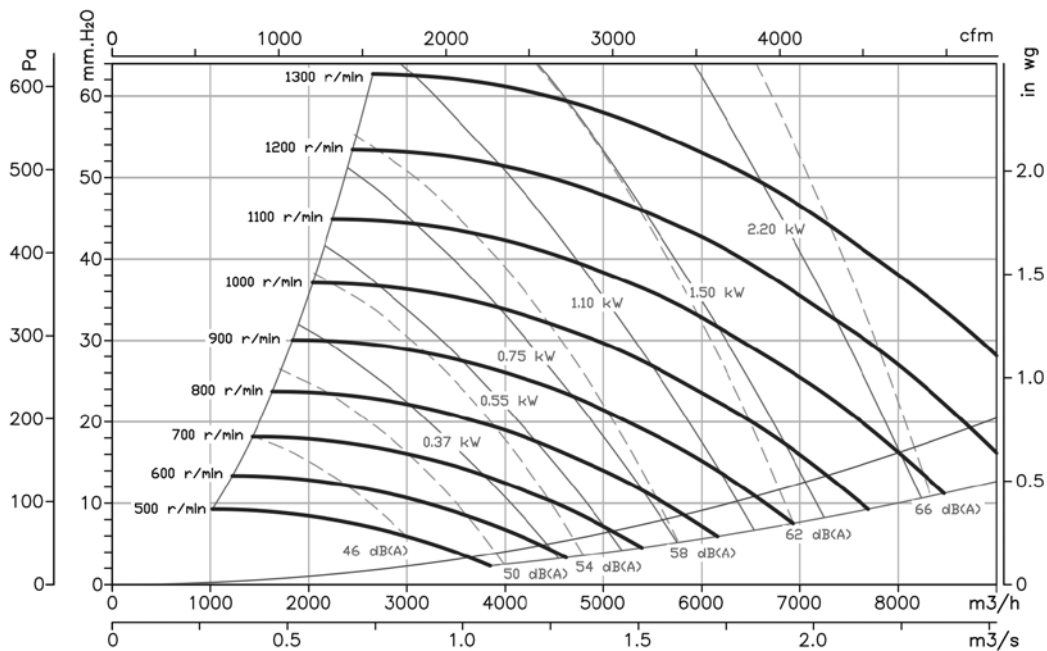

Curvas Características

Q= Caudal en m³/h, m³/s y cfm

Pe= Presión estática en mmH₂O, Pa e inwg.

15/15

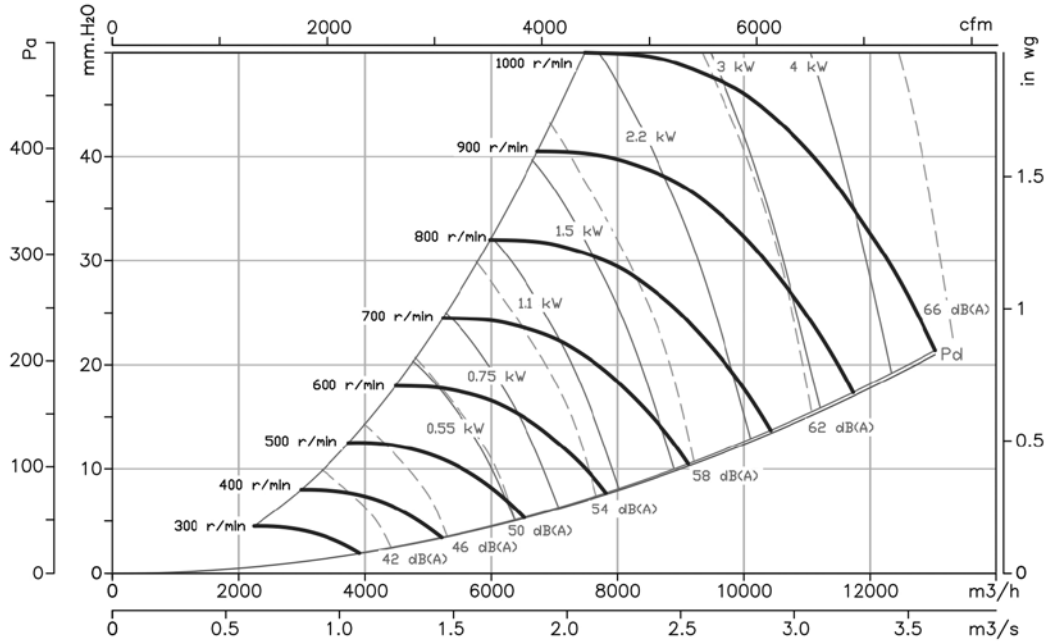

18/18

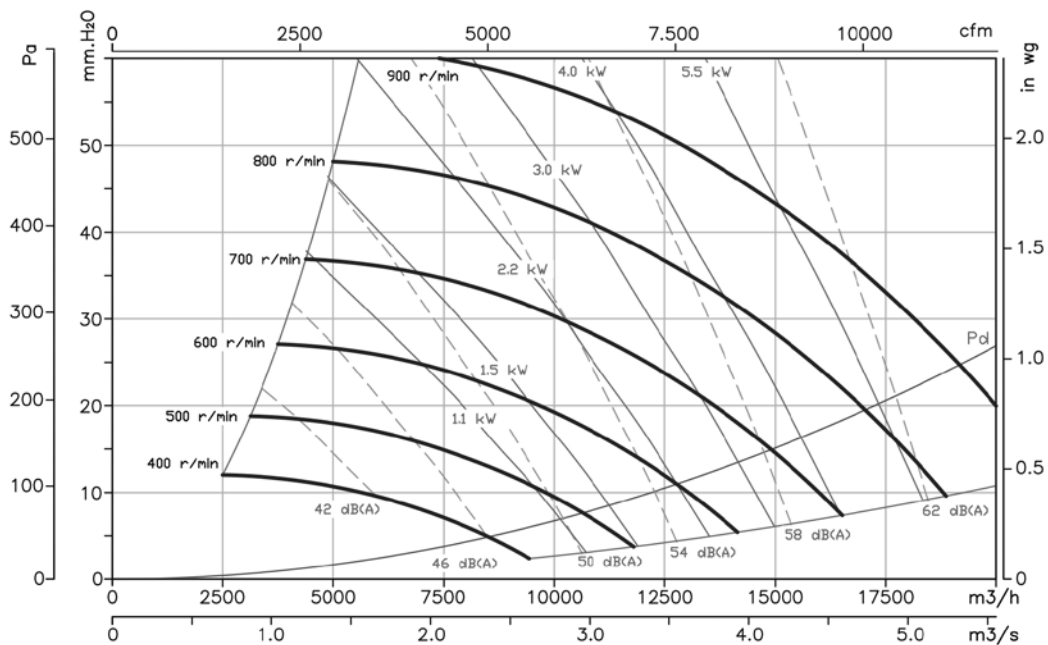

Curvas Características

Q= Caudal en m³/h, m³/s y cfm

Pe= Presión estática en mmH₂O, Pa e inwg.

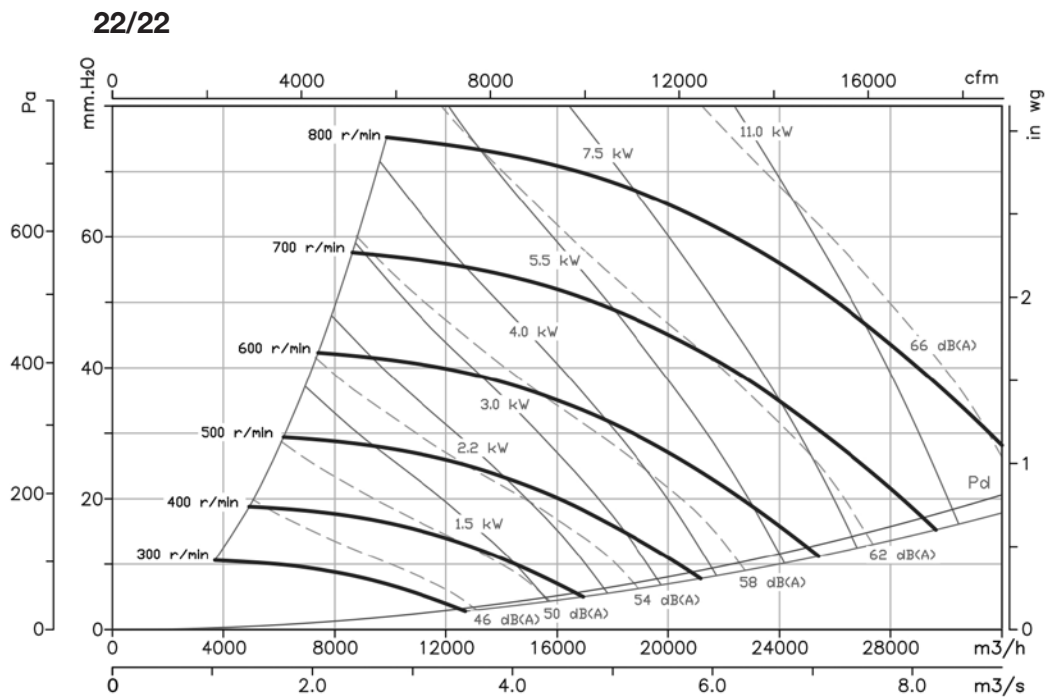
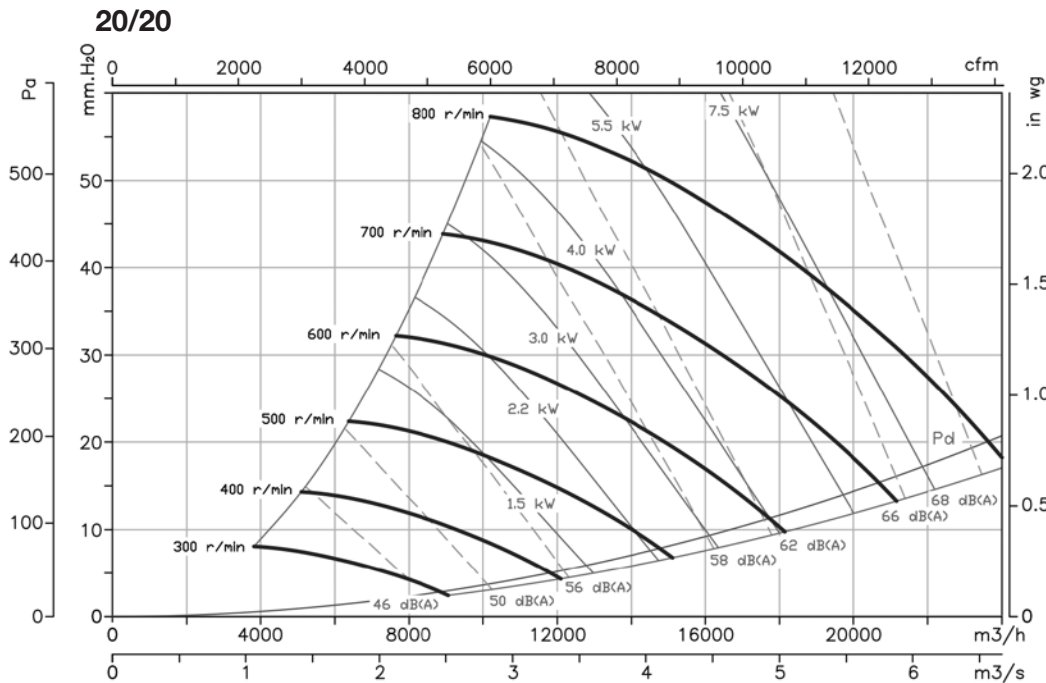

Curvas Características

Q= Caudal en m³/h, m³/s y cfm

Pe= Presión estática en mmH₂O, Pa e in wg.

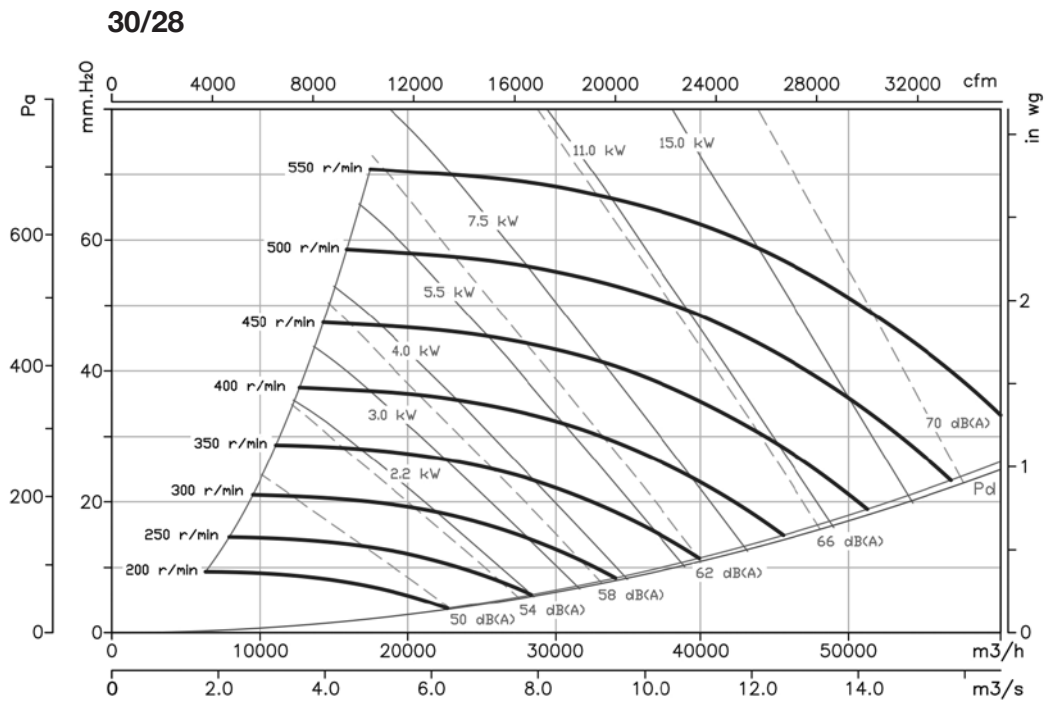
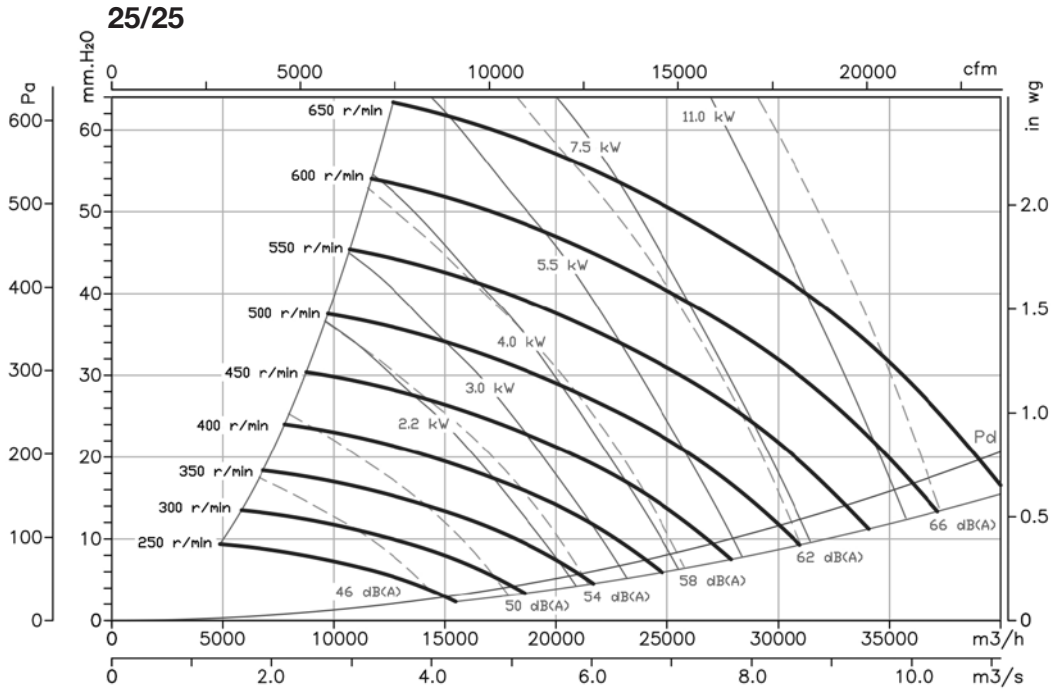

Accesorios



INT

C2V

RM

VSD3/A-RFT

AET

VIS

TEJ

CDXR CDXRT CJDXR

CDXR: Ventiladores centrífugos de doble aspiración a transmisión, con salida de eje por ambos lados y turbina con álabes hacia atrás

CDXRT: Ventiladores centrífugos de doble aspiración a transmisión, equipados con motor eléctrico, conjunto de poleas, correas, protectores y turbina con álabes hacia atrás.

CJDXR: Unidades de ventilación con turbina de álabes hacia atrás, aisladas acústicamente, equipadas con ventiladores de la serie CDXR, sobre amortiguadores de goma

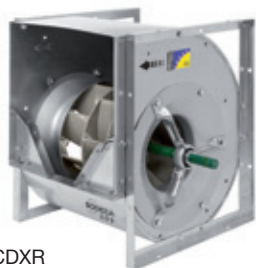

CDXR

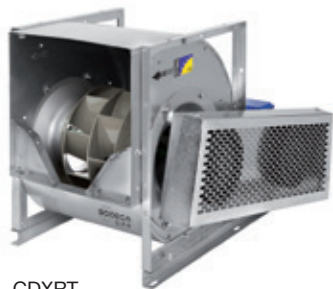

CDXRT



CJDXR

Ventilador:

- Envoltorio en chapa de acero galvanizado
- Turbina con álabes hacia atrás, en chapa de acero galvanizado
- Estructura en chapa de acero galvanizado, con aislamiento térmico y acústico (CJDXR)
- Prensaestopas para entrada de cable CJDXR)

Motor:

- Motores de eficiencia IE3 para potencias iguales o superiores a 0,75kW, excepto monofásicos, 2 velocidades y 8 polos.
- Motores clase F, con rodamientos a bolas protección IP55
- Motor Multitensión, diseño especial válido para: 220/380V 60Hz, 254/440V 60Hz, 265/460V 60Hz, 277/480V 60Hz
- Temperatura máxima del aire a transportar: -20°C. +60°C.

Acabado:

- Anticorrosivo en chapa de acero galvanizado

Bajo demanda:

- Diferentes posiciones de boca de impulsión
- Bobinados especiales para diferentes tensiones
- Con motores de 2 velocidades

Código de pedido

CDXR — **450** — **60Hz**

CDXR: Ventiladores centrífugos de doble aspiración, con salida de eje y turbina con álabes hacia atrás.

Tamaño turbina en mm

CDXRT — **450** — **3** — **60Hz**

CDXRT: Ventiladores centrífugos de doble aspiración a transmisión, equipados con motor eléctrico turbina, con álabes hacia atrás.

Tamaño turbina en mm

Potencia motor (c.v.)

CJDXR: Unidades de ventilación con turbina de álabes hacia atrás.

Características técnicas

60Hz

Modelo	Velocidad máx. (r/min)	Potencia instalada (kW)	Caudal máximo (m³/h)	Temperatura del aire (°C)		Peso aprox. (Kg)
				mín.	máx.	
CDXR-200	4900	2,2	3950	-20	85	10,0
CDXR-250	4100	3,0	5500	-20	85	18,0
CDXR-315	3200	4,0	10550	-20	85	32,6
CDXR-355	2800	5,5	13950	-20	85	42,7
CDXR-400	2400	5,5	16000	-20	85	50,6
CDXR-450	2200	7,5	20700	-20	85	67,5
CDXR-500	2000	11,0	27200	-20	85	84,2
CDXR-560	1800	15,0	34710	-20	85	142,0
CDXR-630	1700	22,0	47000	-20	85	168,0
CDXR-710	1400	22	53750	-20	85	223

Características técnicas

Modelo	Velocidad máx. (r/min)	Intensidad máx admisible (A)		Potencia instalada (kW)	Caudal máximo (m³/h)	Temperatura del aire (°C)		Peso aprox. (Kg)	Tipo Montaje
		220-277V	380-480V			mín.	máx.		
CDXRT CJDXR 355-0,5	1085	1,84	1,06	0,37	5600	-20	+85	47,7	A
CDXRT CJDXR 355-0,75	1230	2,28	1,31	0,55	6400	-20	+85	49,3	A
CDXRT CJDXR 355-1	1360	3,10	1,79	0,75	7100	-20	+85	50,9	A
CDXRT CJDXR 355-1,5	1540	4,03	2,32	1,10	8060	-20	+85	52,6	A
CDXRT CJDXR 355-2	1700	5,96	3,44	1,50	8890	-20	+85	55,6	A
CDXRT CJDXR 355-3	1930	8,36	4,83	2,20	10100	-20	+85	58,4	A
CDXRT CJDXR 355-4	2180	10,96	6,33	3,00	11395	-20	+85	65,7	A
CDXRT CJDXR 355-5,5	2400	14,10	8,12	4,00	12545	-20	+85	72,7	B
CDXRT CJDXR 355-7,5	2670		11,60	5,50	13955	-20	+85	85,7	B
CDXRT CJDXR 400-0,75	1010	2,28	1,31	0,55	7340	-20	+85	57,2	A
CDXRT CJDXR 400-1	1130	3,10	1,79	0,75	8140	-20	+85	58,8	A
CDXRT CJDXR 400-1,5	1290	4,03	2,32	1,10	9350	-20	+85	60,5	A
CDXRT CJDXR 400-2	1420	5,96	3,44	1,50	10260	-20	+85	63,5	A
CDXRT CJDXR 400-3	1620	8,36	4,83	2,20	11650	-20	+85	66,3	A
CDXRT CJDXR 400-4	1820	10,96	6,33	3,00	13110	-20	+85	73,6	A
CDXRT CJDXR 400-5,5	2000	14,10	8,12	4,00	14430	-20	+85	80,6	B
CDXRT CJDXR 400-7,5	2230		11,60	5,50	16040	-20	+85	93,6	B
CDXRT CJDXR 450-1	940	3,10	1,79	0,75	9500	-20	+85	75,7	A
CDXRT CJDXR 450-1,5	1075	4,03	2,32	1,10	10750	-20	+85	77,4	A
CDXRT CJDXR 450-2	1190	5,96	3,44	1,50	11960	-20	+85	80,4	A
CDXRT CJDXR 450-3	1340	8,36	4,83	2,20	13600	-20	+85	83,2	A
CDXRT CJDXR 450-4	1510	10,96	6,33	3,00	15100	-20	+85	90,5	A
CDXRT CJDXR 450-5,5	1670	14,10	8,12	4,00	16835	-20	+85	97,5	B
CDXRT CJDXR 450-7,5	1850		11,60	5,50	18500	-20	+85	110,5	B
CDXRT CJDXR 450-10	2060		14,20	7,50	20760	-20	+85	120,5	B
CDXRT CJDXR 500-1,5	880	4,03	2,32	1,10	12460	-20	+85	94,1	A
CDXRT CJDXR 500-2	970	5,96	3,44	1,50	13815	-20	+85	97,1	A
CDXRT CJDXR 500-3	1100	8,36	4,83	2,20	15700	-20	+85	99,9	A
CDXRT CJDXR 500-4	1240	10,96	6,33	3,00	17650	-20	+85	107,2	A
CDXRT CJDXR 500-5,5	1370	14,10	8,12	4,00	19430	-20	+85	114,2	B
CDXRT CJDXR 500-7,5	1510		11,60	5,50	21600	-20	+85	127,2	B
CDXRT CJDXR 500-10	1675		14,20	7,50	23950	-20	+85	137,2	B
CDXRT CJDXR 500-15	1910		20,20	11,00	27220	-20	+85	156,2	B
CDXRT CJDXR 560-2	810	5,96	3,44	1,50	15620	-20	+85	154,9	A
CDXRT CJDXR 560-3	925	8,36	4,83	2,20	17830	-20	+85	157,7	A
CDXRT CJDXR 560-4	1050	10,96	6,33	3,00	20380	-20	+85	165,0	A
CDXRT CJDXR 560-5,5	1150	14,10	8,12	4,00	22170	-20	+85	172,0	B
CDXRT CJDXR 560-7,5	1290		11,60	5,50	24940	-20	+85	185,0	B
CDXRT CJDXR 560-10	1420		14,20	7,50	27658	-20	+85	195,0	B
CDXRT CJDXR 560-15	1610		20,20	11,00	31050	-20	+85	214,0	B
CDXRT CJDXR 560-20	1800		27,50	15,00	34710	-20	+85	227,0	B
CDXRT CJDXR 630-3	740	8,36	4,83	2,20	21210	-20	+85	183,7	A
CDXRT CJDXR 630-4	830	10,96	6,33	3,00	23860	-20	+85	191,0	A
CDXRT CJDXR 630-5,5	920	14,10	8,12	4,00	26260	-20	+85	198,0	B
CDXRT CJDXR 630-7,5	1020		11,60	5,50	29200	-20	+85	211,0	B
CDXRT CJDXR 630-10	1135		14,20	7,50	32385	-20	+85	221,0	B
CDXRT CJDXR 630-15	1285		20,20	11,00	36800	-20	+85	240,0	B
CDXRT CJDXR 630-20	1450		27,50	15,00	41415	-20	+85	253,0	B
CDXRT CJDXR 630-25	1550		35,00	18,50	44410	-20	+85	270,0	B
CDXRT CJDXR 630-30	1640		42,00	22,00	47050	-20	+85	313,0	B
CDXRT CJDXR 710-3	580	8,36	4,83	2,20	23200	-20	+85	238,7	A
CDXRT CJDXR 710-4	655	10,96	6,33	3,00	26200	-20	+85	246,0	A
CDXRT CJDXR 710-5,5	730	14,10	8,12	4,00	29200	-20	+85	253,0	B
CDXRT CJDXR 710-7,5	805		11,60	5,50	32200	-20	+85	266,0	B
CDXRT CJDXR 710-10	890		14,20	7,50	35600	-20	+85	276,0	B
CDXRT CJDXR 710-15	1015		20,20	11,00	40600	-20	+85	295,0	B
CDXRT CJDXR 710-20	1140		27,50	15,00	45600	-20	+85	308,0	B
CDXRT CJDXR 710-25	1225		35,00	18,50	49000	-20	+85	325,0	B
CDXRT CJDXR 710-30	1300		42,00	22,00	52000	-20	+85	368,0	B

Dimensiones mm

CDXR 200 - 250

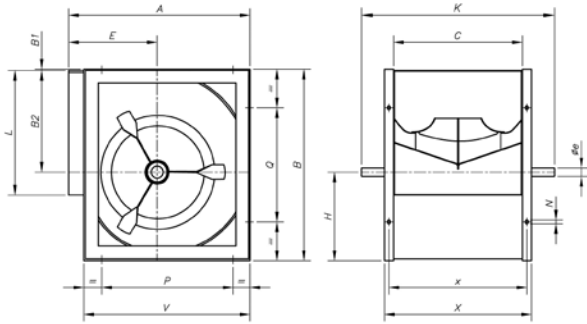

CDXR 315...710

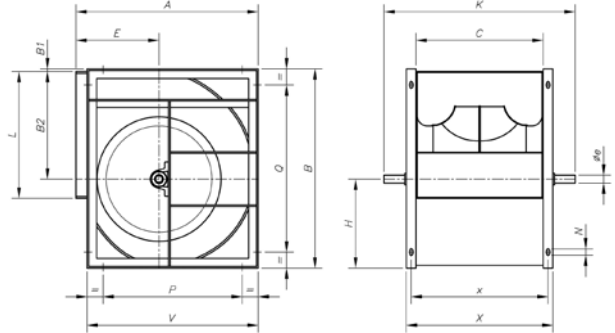

	A	B	B1	B2	C	E	øe	H	K	L	N	P	Q	V	X	x
CDXR-200	343	370	4	215	256	164	20	151	420	256	11x16	224	224	306	306	281
CDXR-250	419	461	4	270	322	195	20	187	490	322	11x16	224	224	384	372	347
CDXR-315	518	578	3	340	404	236	25	235	640	404	13x18	280	280	480	464	434
CDXR-355	578	655	6	383	453	261	30	266	700	453	13x18	355	355	548	533	493
CDXR-400	651	736	4,5	431,5	507	290	30	300	760	507	13x18	355	355	613	587	547
CDXR-450	728	827	5	486	569	322	35	336	845	569	13x18	530	530	681	649	609
CDXR-500	800	918	5	538	638	352	35	375	915	638	13x18	530	530	750	718	678
CDXR-560	893	1030	8	602	715	390	40	420	1000	715	13x18	530	530	845	815	765
CDXR-630	999	1157	7	678,5	801	434	45	471,5	1090	801	13x18	530	530	946	901	851
CDXR-710	1121	1303	7	765	898	485	50	531	1255	898	17x22	630	630	1058	998	948

CDXRT Montaje A

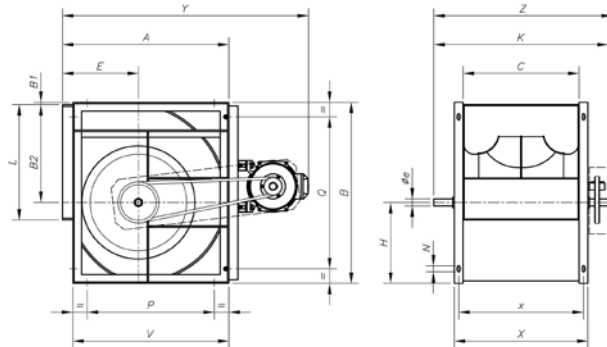

Modelo	A	B	B1	B2	C	E	øe	H	K	L	N	P	Q	V	X	x	Y	Z
CDXRT-355-0'5	578	655	6	383	453	261	30	266	700	453	13x18	355	355	548	533	493	830	780
CDXRT-355-0'75	578	655	6	383	453	261	30	266	700	453	13x18	355	355	548	533	493	850	780
CDXRT-355-1	578	655	6	383	453	261	30	266	700	453	13x18	355	355	548	533	493	850	780
CDXRT-355-1'5	578	655	6	383	453	261	30	266	700	453	13x18	355	355	548	533	493	870	780
CDXRT-355-2	578	655	6	383	453	261	30	266	700	453	13x18	355	355	548	533	493	870	780
CDXRT-355-3	578	655	6	383	453	261	30	266	700	453	13x18	355	355	548	533	493	885	780
CDXRT-355-4	578	655	6	383	453	261	30	266	700	453	13x18	355	355	548	533	493	885	780
CDXRT-400-0'75	651	736	4,5	431,5	507	290	30	300	760	507	13x18	355	355	613	587	547	925	840
CDXRT-400-1	651	736	4,5	431,5	507	290	30	300	760	507	13x18	355	355	613	587	547	925	840
CDXRT-400-1'5	651	736	4,5	431,5	507	290	30	300	760	507	13x18	355	355	613	587	547	940	840
CDXRT-400-2	651	736	4,5	431,5	507	290	30	300	760	507	13x18	355	355	613	587	547	940	840
CDXRT-400-3	651	736	4,5	431,5	507	290	30	300	760	507	13x18	355	355	613	587	547	956	840
CDXRT-400-4	651	736	4,5	431,5	507	290	30	300	760	507	13x18	355	355	613	587	547	956	840
CDXRT-450-1	728	827	5	486	569	322	35	336	845	569	13x18	530	530	681	649	609	1000	925
CDXRT-450-1'5	728	827	5	486	569	322	35	336	845	569	13x18	530	530	681	649	609	1020	925
CDXRT-450-2	728	827	5	486	569	322	35	336	845	569	13x18	530	530	681	649	609	1020	925
CDXRT-450-3	728	827	5	486	569	322	35	336	845	569	13x18	530	530	681	649	609	1035	925
CDXRT-450-4	728	827	5	486	569	322	35	336	845	569	13x18	530	530	681	649	609	1035	925
CDXRT-500-1'5	800	918	5	538	638	352	35	375	915	638	13x18	530	530	750	718	678	1090	995
CDXRT-500-2	800	918	5	538	638	352	35	375	915	638	13x18	530	530	750	718	678	1090	995
CDXRT-500-3	800	918	5	538	638	352	35	375	915	638	13x18	530	530	750	718	678	1105	995
CDXRT-500-4	800	918	5	538	638	352	35	375	915	638	13x18	530	530	750	718	678	1105	995
CDXRT-560-2	893	1030	8	602	715	390	40	420	1000	715	13x18	530	530	845	815	765	1185	1080
CDXRT-560-3	893	1030	8	602	715	390	40	420	1000	715	13x18	530	530	845	815	765	1205	1080
CDXRT-560-4	893	1030	8	602	715	390	40	420	1000	715	13x18	530	530	845	815	765	1205	1080
CDXRT-630-3	999	1157	7	678,5	801	434	45	471,5	1090	801	13x18	530	530	946	901	851	1310	1170
CDXRT-630-4	999	1157	7	678,5	801	434	45	471,5	1090	801	13x18	530	530	946	901	851	1310	1170
CDXRT-710-3	1121	1303	7	765	898	485	50	531	1255	898	17x22	630	630	1058	998	948	1435	1335
CDXRT-710-4	1121	1303	7	765	898	485	50	531	1255	898	17x22	630	630	1058	998	948	1435	1335

Dimensiones mm

CDXRT
Montaje B

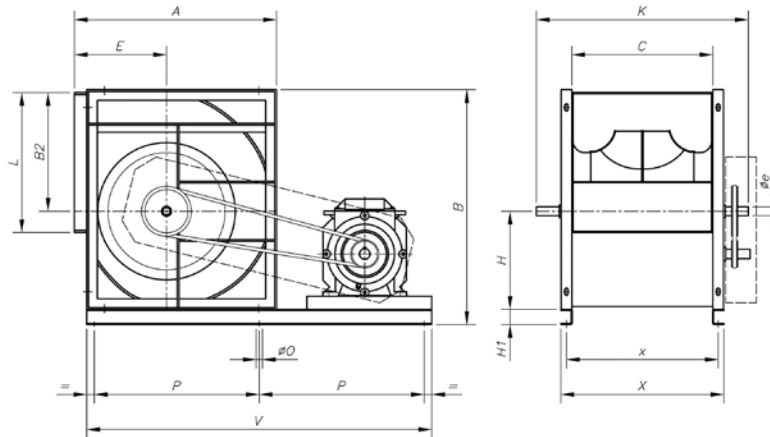

Modelo	A	B	B2	C	E	øe	H	H1	K	ø0	P	V	x	X
CDXRT-355-5'5	578	715	383	453	261	30	266	60	700	8	-	1110	493	533
CDXRT-355-7'5	578	715	383	453	261	30	266	60	700	8	-	1110	493	533
CDXRT-400-5'5	651	796	431,5	507	290	30	300	60	760	10	-	1210	547	587
CDXRT-400-7'5	651	796	431,5	507	290	30	300	60	760	10	-	1210	547	587
CDXRT-450-5'5	728	887	486	569	322	35	336	60	845	10	-	1330	609	649
CDXRT-450-7'5	728	887	486	569	322	35	336	60	845	10	-	1330	609	649
CDXRT-450-10	728	887	486	569	322	35	336	60	845	10	-	1330	609	649
CDXRT-500-5'5	800	978	538	638	352	35	375	60	915	10	670	1430	678	718
CDXRT-500-7'5	800	978	538	638	352	35	375	60	915	10	670	1430	678	718
CDXRT-500-10	800	978	538	638	352	35	375	60	915	10	670	1430	678	718
CDXRT-500-15	800	978	538	638	352	35	375	60	915	10	670	1430	678	718
CDXRT-560-5'5	893	1090	602	715	390	40	420	60	1000	10	745	1580	765	815
CDXRT-560-7'5	893	1090	602	715	390	40	420	60	1000	10	745	1580	765	815
CDXRT-560-10	893	1090	602	715	390	40	420	60	1000	10	745	1580	765	815
CDXRT-560-15	893	1090	602	715	390	40	420	60	1000	10	745	1580	765	815
CDXRT-560-20	893	1090	602	715	390	40	420	60	1000	10	745	1580	765	815
CDXRT-630-5'5	999	1217	678,5	801	434	45	471,5	60	1090	10	805	1700	851	901
CDXRT-630-7'5	999	1217	678,5	801	434	45	471,5	60	1090	10	805	1700	851	901
CDXRT-630-10	999	1217	678,5	801	434	45	471,5	60	1090	10	805	1700	851	901
CDXRT-630-15	999	1217	678,5	801	434	45	471,5	60	1090	10	805	1700	851	901
CDXRT-630-20	999	1217	678,5	801	434	45	471,5	60	1090	10	805	1700	851	901
CDXRT-630-25	999	1217	678,5	801	434	45	471,5	60	1090	10	805	1700	851	901
CDXRT-630-30	999	1217	678,5	801	434	45	471,5	60	1090	10	805	1700	851	901
CDXRT-710-5'5	1121	1383	765	898	485	50	531	80	1255	10	955	2000	948	998
CDXRT-710-7'5	1121	1383	765	898	485	50	531	80	1255	10	955	2000	948	998
CDXRT-710-10	1121	1383	765	898	485	50	531	80	1255	10	955	2000	948	998
CDXRT-710-15	1121	1383	765	898	485	50	531	80	1255	10	955	2000	948	998
CDXRT-710-20	1121	1383	765	898	485	50	531	80	1255	10	955	2000	948	998
CDXRT-710-25	1121	1383	765	898	485	50	531	80	1255	10	955	2000	948	998
CDXRT-710-30	1121	1383	765	898	485	50	531	80	1255	10	955	2000	948	998

CJDXR

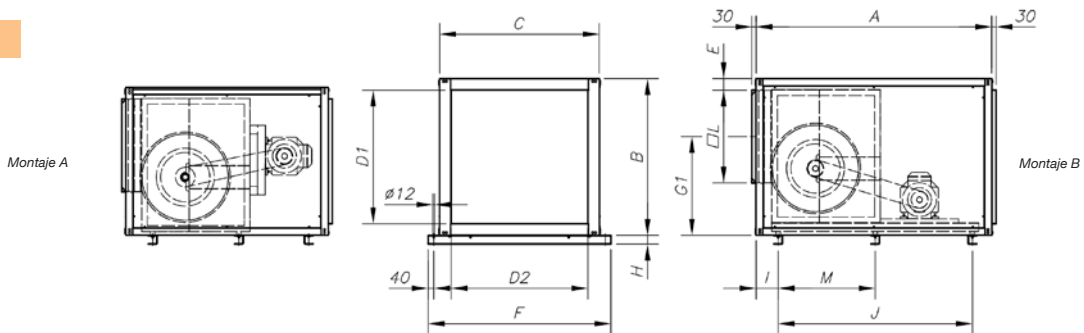

Modelo	A	B	C	D1	D2	E	F	G1	H	I	J	L	M
CJDXR-355	1265	815	800	655	640	84,5	960	503,5	60	165	1020	454	-
CJDXR-400	1370	900	900	740	743	82	1060	564	60	152	1120	508	-
CJDXR-450	1480	990	1000	830	843	80,5	1160	623,5	60	152	1240	570	-
CJDXR-500	1625	1080	1100	920	942	80	1260	680,5	60	152	1340	639	670
CJDXR-560	1760	1195	1200	1035	1040	82,5	1360	851,5	60	165	1490	716	745
CJDXR-630	1880	1322	1300	1162	1142	80	1460	841	60	152	1610	802	820
CJDXR-710	2180	1500	1500	1340	1342	82	1660	968,5	80	168	1910	899	955

Curvas Características

Q= Caudal en m³/h, m³/s y cfm

Pe= Presión estática en mmH₂O, Pa e inwg.

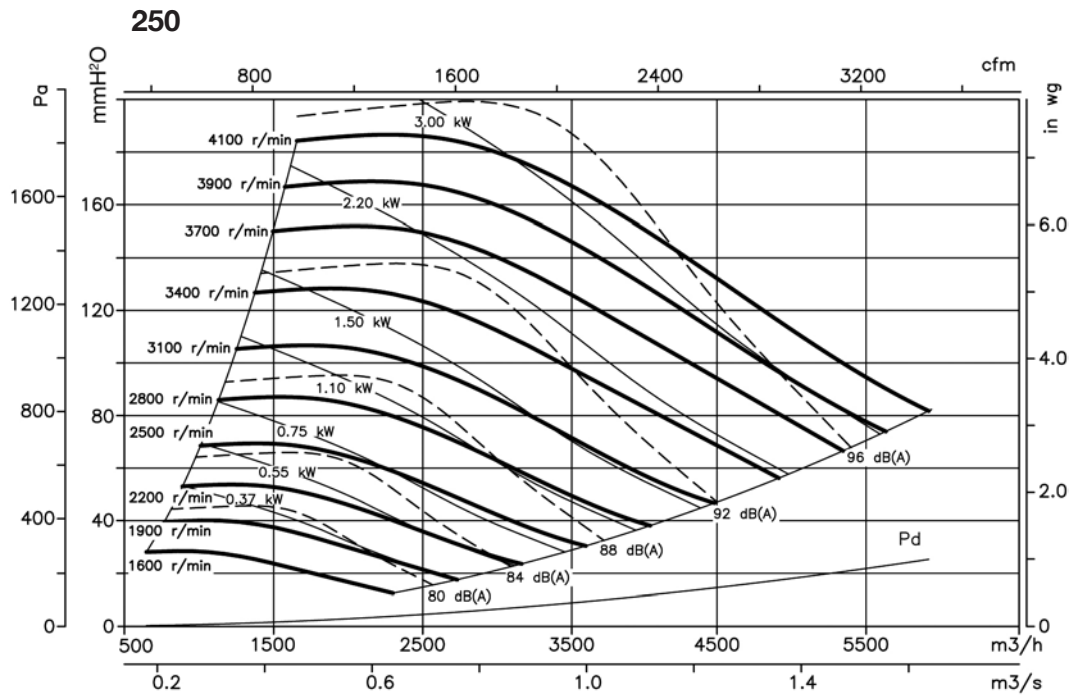
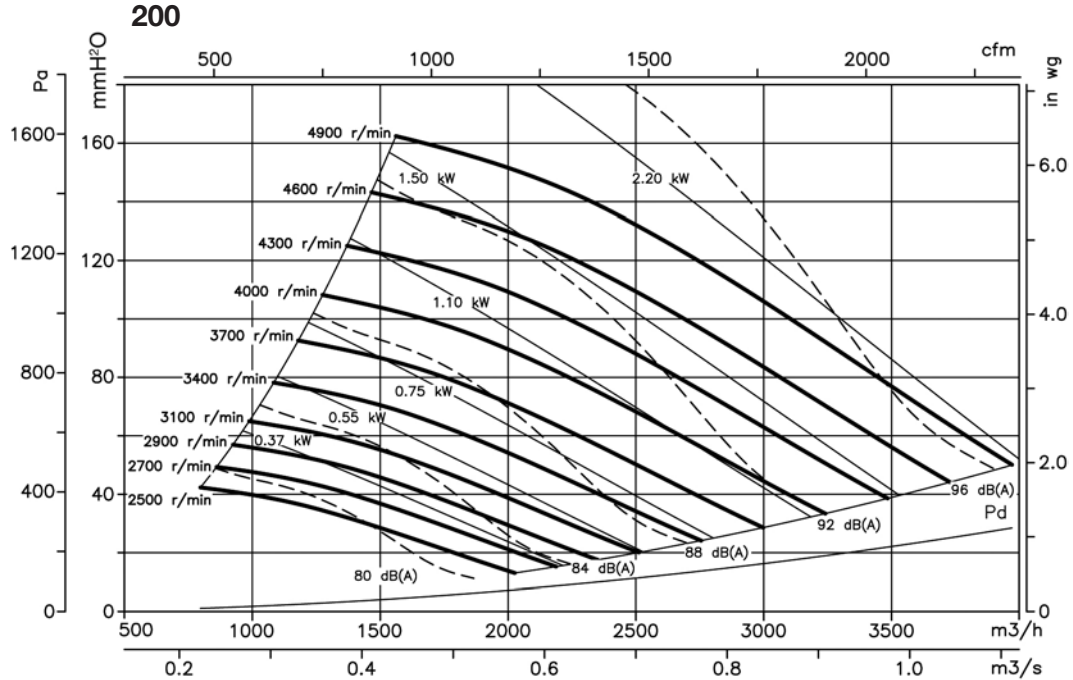

Curvas Características

Q= Caudal en m³/h, m³/s y cfm

Pe= Presión estática en mmH₂O, Pa e inwg.

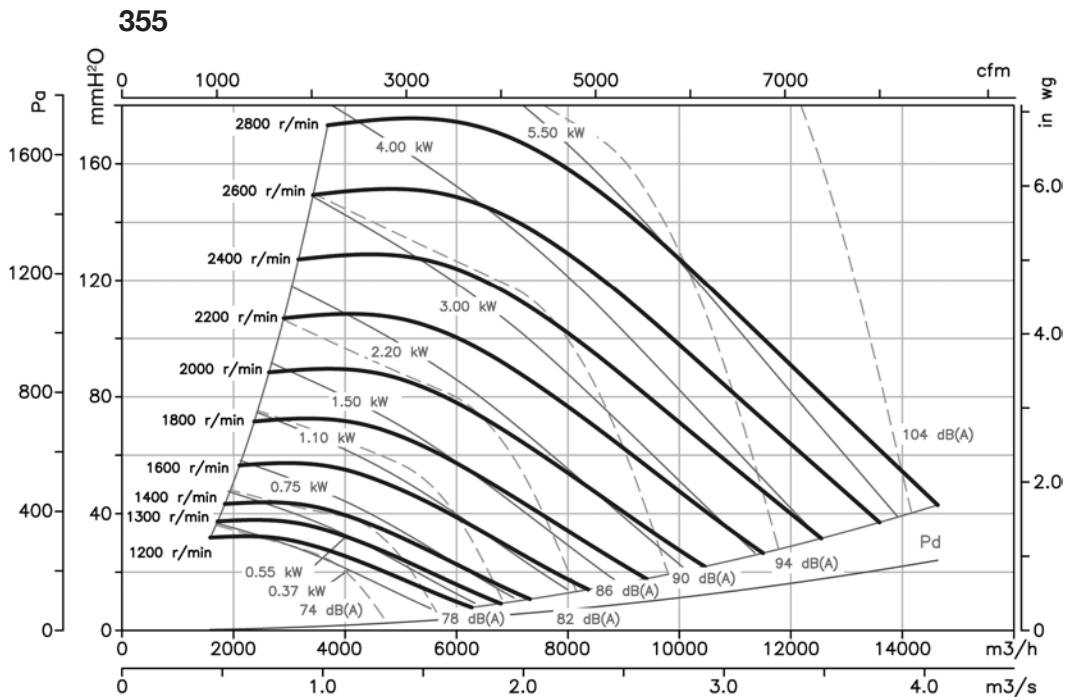
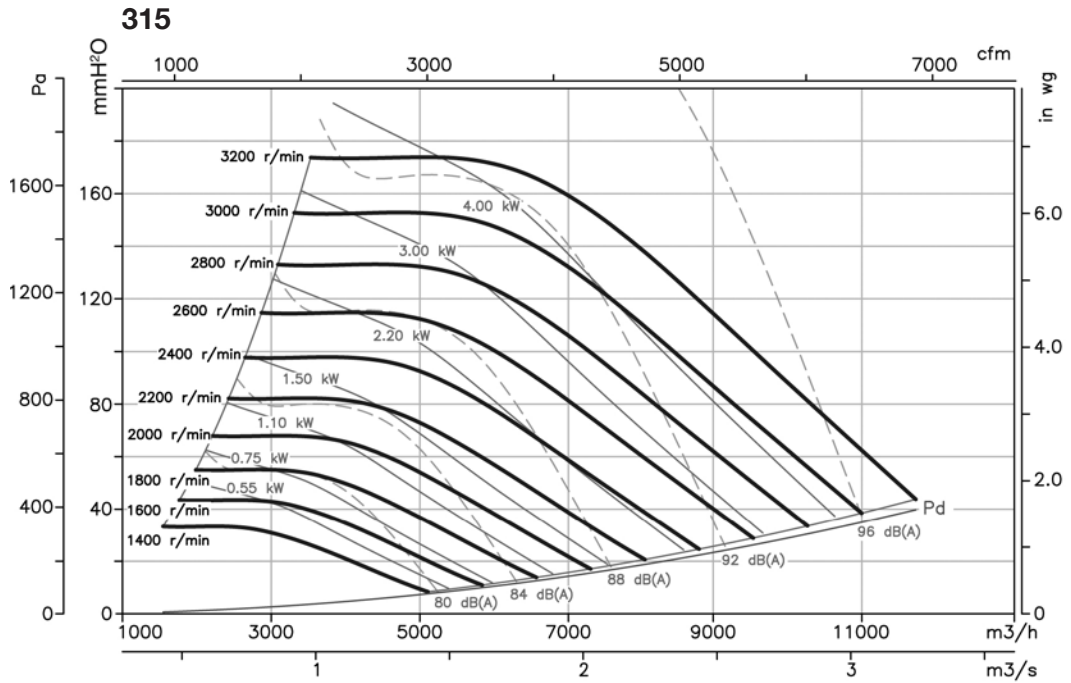

Curvas características

Q= Caudal en m³/h, m³/s y cfm.

Pe= Presión estática en mmH₂O, Pa e inwg.

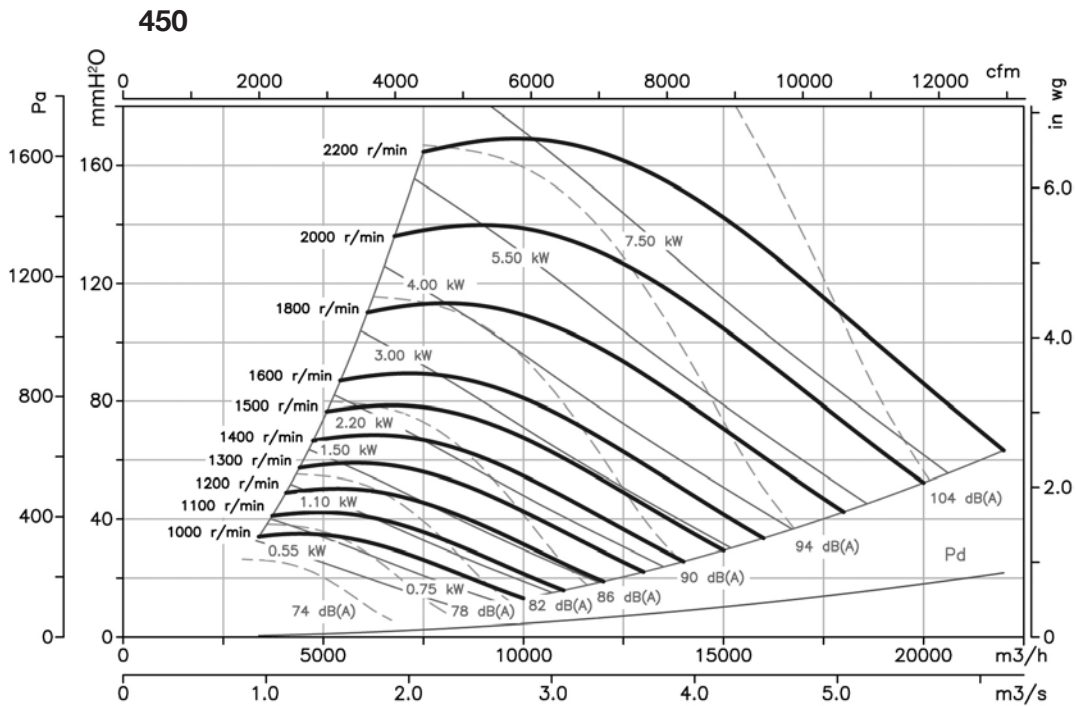
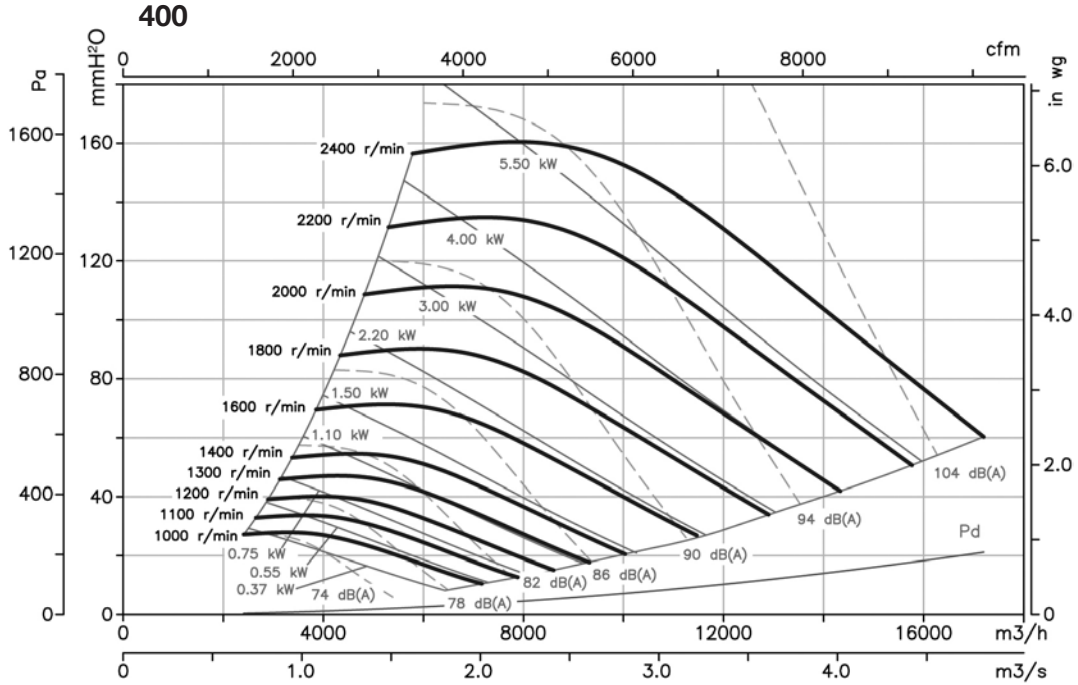

Curvas características

Q= Caudal en m³/h, m³/s y cfm.

Pe= Presión estática en mmH₂O, Pa e in wg.

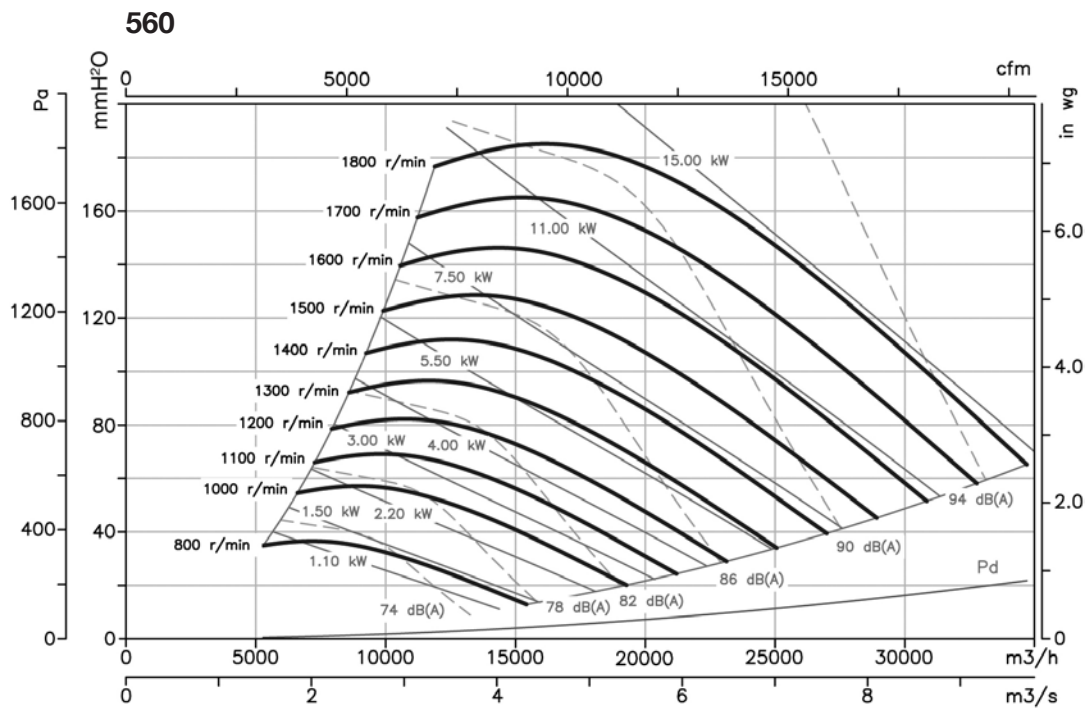
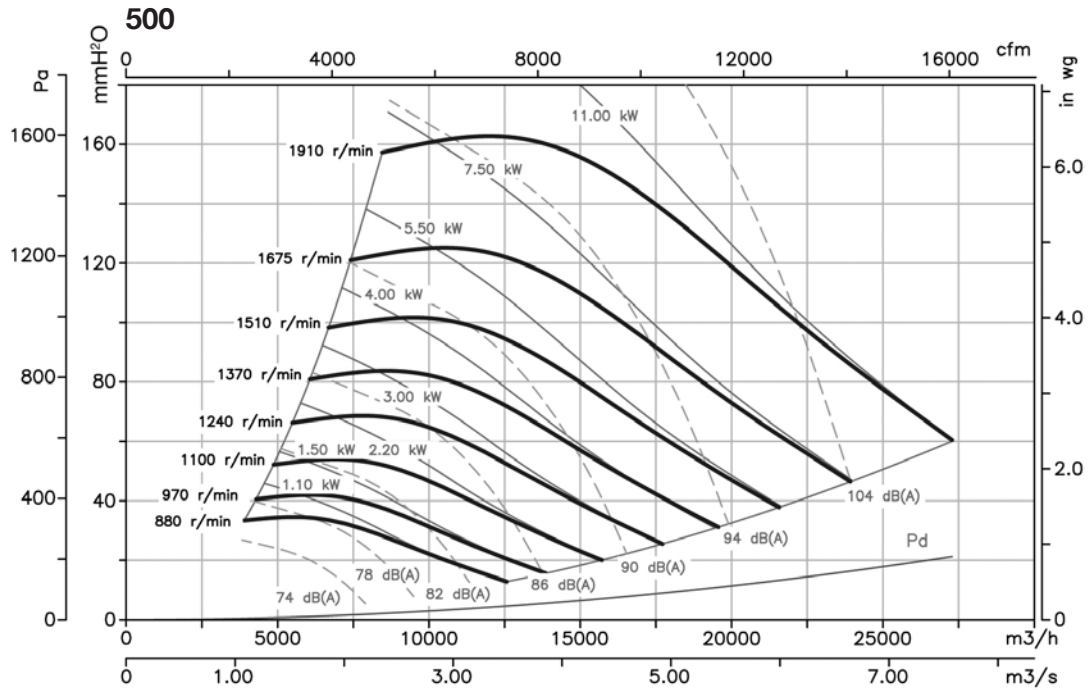

Curvas características

Q= Caudal en m³/h, m³/s y cfm.

Pe= Presión estática en mmH²O, Pa e inwg.

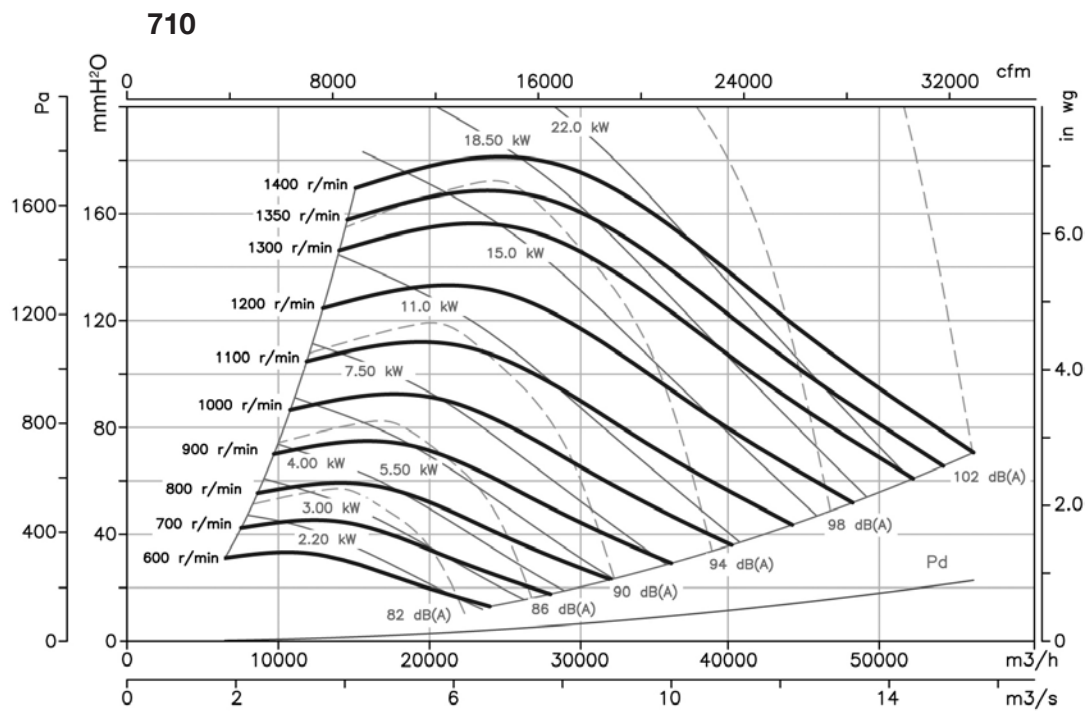
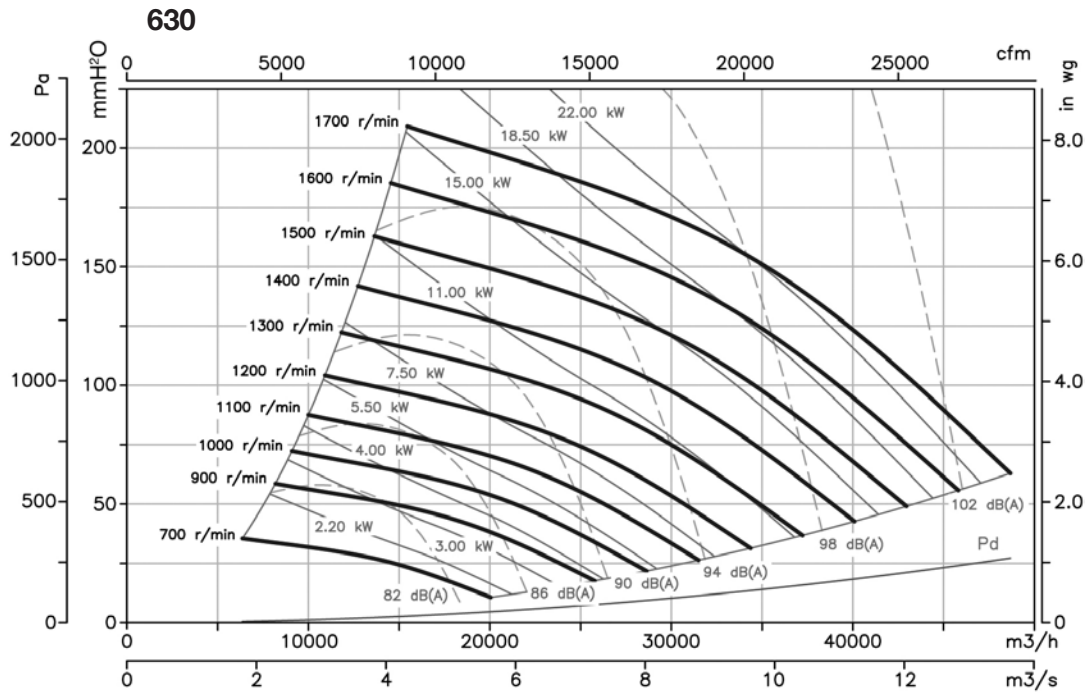

Accesorios



INT C2V RM VSD3/A-RFT AET VIS TEJ

CSXR CSXRT CJSXR

CSXR: Ventiladores centrífugos de simple aspiración a transmisión, con salida de eje y turbina con álabes hacia atrás

CSXRT: Ventiladores centrífugos de simple aspiración a transmisión, equipados con motor eléctrico, conjunto de poleas, correas, protectores y turbina con álabes hacia atrás

CJSXR: Unidades de ventilación con turbina de álabes hacia atrás aisladas acústicamente, equipadas con ventiladores de la serie CSXR, sobre amortiguadores de goma

Ventilador:

- Envoltente en chapa de acero galvanizado
- Turbina con álabes hacia atrás, en chapa de acero galvanizado
- Estructura en chapa de acero galvanizado, con aislamiento térmico y acústico (CJSXR)
- Prensaestopas para entrada de cable (CJSXR)

Motor:

- Motores de eficiencia IE3 para potencias iguales o superiores a 0,75kW, excepto monofásicos, 2 velocidades y 8 polos.
- Motores clase F, con rodamientos a bolas protección IP55
- Motor Multitensión, diseño especial válido para: 220/380V 60Hz, 254/440V 60Hz, 265/460V 60Hz, 277/480V 60Hz
- Temperatura máxima del aire a transportar: -20°C. +60°C.

Acabado:

- Anticorrosivo en chapa de acero galvanizado

Bajo demanda:

- Diferentes posiciones de boca de impulsión
- Bobinados especiales para diferentes tensiones
- Con motores de 2 velocidades



CSXR



CSXRT



CJSXR

Código de pedido



CSXR: Ventiladores centrífugos de simple aspiración, con salida de eje

Tamaño turbina



CSXRT: Ventiladores centrífugos de simple aspiración, equipados con motor

Tamaño turbina

Potencia motor (c.v.)

CJSXR: Unidades de ventilación con turbina de álabes hacia atrás

Características técnicas

60Hz

Modelo	Velocidad máx. (r/min)	Máx. Potencia instalada (kW)	Caudal máximo (m³/h)	Temperatura del aire (°C)		Peso aprox. (Kg)
				mín.	máx.	
CSXR-315	3200	1,50	4345	-20	+85	27
CSXR-355	2800	2,20	5905	-20	+85	39
CSXR-400	2400	3,00	7850	-20	+85	44
CSXR-450	2200	4,00	10045	-20	+85	55
CSXR-500	2200	5,50	12855	-20	+85	70
CSXR-560	2000	7,50	17555	-20	+85	110
CSXR-630	1600	7,50	18600	-20	+85	125
CSXR-710	1400	7,50	23200	-20	+85	175
CSXR-800	1600	22,00	39430	-20	+85	252
CSXR-900	1400	30,00	46375	-20	+85	360
CSXR-1000	1400	45,00	58225	-20	+85	445

Características técnicas

Modelo	Velocidad máx. (r/min)	Intensidad máx admisible (A)		Potencia instalada (kW)	Caudal máximo (m³/h)	Peso aprox. (Kg)	Tipo Montaje	
		220-277V	380-480V				CSXRT	CJSXR
CSXRT CJSXR 315-0,75	2520	2,4	1,4	0,55	4000	32	A	B
CSXRT CJSXR 315-1	2800	3,1	1,8	0,75	4500	34	A	B
CSXRT CJSXR 315-1,5	3250	4,4	2,5	1,1	5050	36	A	B
CSXRT CJSXR 355-0,75	2100	2,4	1,4	0,55	4750	41	A	B
CSXRT CJSXR 355-1	2300	3,1	1,8	0,75	5200	44	A	B
CSXRT CJSXR 355-1,5	2600	4,4	2,5	1,1	6000	46	A	B
CSXRT CJSXR 355-2	2875	5,8	3,4	1,5	6650	48	A	B
CSXRT CJSXR 400-0,75	1730	2,4	1,4	0,55	5600	49	A	B
CSXRT CJSXR 400-1	1900	3,3	1,9	0,75	6100	52	A	B
CSXRT CJSXR 400-1,5	2180	4,5	2,6	1,1	7000	54	A	B
CSXRT CJSXR 400-2	2400	5,8	3,4	1,5	7700	56	A	B
CSXRT CJSXR 450-0,75	1230	2,4	1,4	0,55	5800	61	A	B
CSXRT CJSXR 450-1	1380	3,3	1,9	0,75	6500	64	A	B
CSXRT CJSXR 450-1,5	1550	4,5	2,6	1,1	7500	66	A	B
CSXRT CJSXR 450-2	1700	6,0	3,5	1,5	8050	68	A	B
CSXRT CJSXR 450-3	1950	8,4	4,8	2,2	9050	72	A	B
CSXRT CJSXR 450-4	2200	10,4	6,0	3	10100	76	A	B
CSXRT CJSXR 500-1,5	1250	4,5	2,6	1,1	8200	88	A	B
CSXRT CJSXR 500-2	1380	6,0	3,5	1,5	9000	90	A	B
CSXRT CJSXR 500-3	1560	8,4	4,8	2,2	10200	93	A	B
CSXRT CJSXR 500-4	1730	11,3	6,5	3	11500	98	A	B
CSXRT CJSXR 500-5,5	1900	13,9	8,0	4	12500	107	A	B
CSXRT CJSXR 500-7,5	2130	-	11,1	5,5	14000	116	A	B
CSXRT CJSXR 560-2	1200	6,0	3,5	1,5	11000	100	A	B
CSXRT CJSXR 560-3	1380	8,4	4,8	2,2	12200	103	A	B
CSXRT CJSXR 560-4	1500	11,3	6,5	3	14000	108	A	B
CSXRT CJSXR 560-5,5	1670	13,9	8,0	4	15500	117	A	B
CSXRT CJSXR 560-7,5	1850	-	11,1	5,5	16200	122	A	B
CSXRT CJSXR 560-10	2050	-	14,8	7,5	18300	132	A	B
CSXRT CJSXR 630-3	1060	8,4	4,8	2,2	13200	119	A	B
CSXRT CJSXR 630-4	1150	11,3	6,5	3	14400	123	A	B
CSXRT CJSXR 630-5,5	1300	13,9	8,0	4	16000	132	A	B
CSXRT CJSXR 630-7,5	1450	-	11,1	5,5	18000	138	A	B
CSXRT CJSXR 630-10	1600	-	14,8	7,5	19800	147	A	B
CSXRT CJSXR 710-4	1000	11,3	6,5	3	17280	186	A	B
CSXRT CJSXR 710-5,5	1100	13,9	8,0	4	19080	195	A	B
CSXRT CJSXR 710-7,5	1200	-	11,1	5,5	20880	200	A	B
CSXRT CJSXR 710-10	1350	-	14,8	7,5	23760	210	A	B
CSXRT CJSXR 710-12,5	1480	-	17,5	9,2	25920	219	A	B
CSXRT 800-4	800	11,3	6,5	3	20800	226	B	
CSXRT 800-5,5	880	13,9	8,0	4	22680	234	B	
CSXRT 800-7,5	970	-	11,1	5,5	25100	240	B	
CSXRT 800-10	1070	-	14,8	7,5	27720	250	B	
CSXRT 800-12,5	1150	-	17,5	9,2	30000	259	B	
CSXRT 800-15	1230	-	22,0	11	32040	284	B	
CSXRT 800-20	1350	-	29,0	15	34000	305	B	
CSXRT 800-25	1450	-	36,5	18,5	37800	325	B	
CSXRT 800-30	1540	-	42,0	22	40000	344	B	
CSXRT 900-4	650	11,3	6,5	3	23760	281	B	
CSXRT 900-5,5	720	13,9	8,0	4	26000	289	B	
CSXRT 900-7,5	790	-	11,1	5,5	29500	295	B	
CSXRT 900-10	860	-	14,8	7,5	32100	305	B	
CSXRT 900-12,5	940	-	17,5	9,2	34200	314	B	
CSXRT 900-15	1020	-	22,0	11	37900	339	B	
CSXRT 900-20	1120	-	29,0	15	42000	360	B	
CSXRT 900-25	1190	-	36,5	18,5	43500	380	B	
CSXRT 900-30	1250	-	42,0	22	45500	399	B	
CSXRT 900-40	1400	-	59,0	30	51000	453	B	
CSXRT 1000-5,5	600	13,9	8,0	4	30500	342	B	
CSXRT 1000-7,5	660	-	11,1	5,5	33000	348	B	
CSXRT 1000-10	730	-	14,8	7,5	37000	358	B	
CSXRT 1000-12,5	790	-	17,5	9,2	40000	366	B	
CSXRT 1000-15	840	-	22,0	11	42500	392	B	
CSXRT 1000-20	940	-	29,0	15	46000	413	B	
CSXRT 1000-25	1000	-	36,5	18,5	50000	432	B	
CSXRT 1000-30	1060	-	42,0	22	52500	452	B	
CSXRT 1000-40	1160	-	59,0	30	59000	506	B	
CSXRT 1000-50	1260	-	68,0	37	64000	549	B	

Dimensiones mm

CSXR

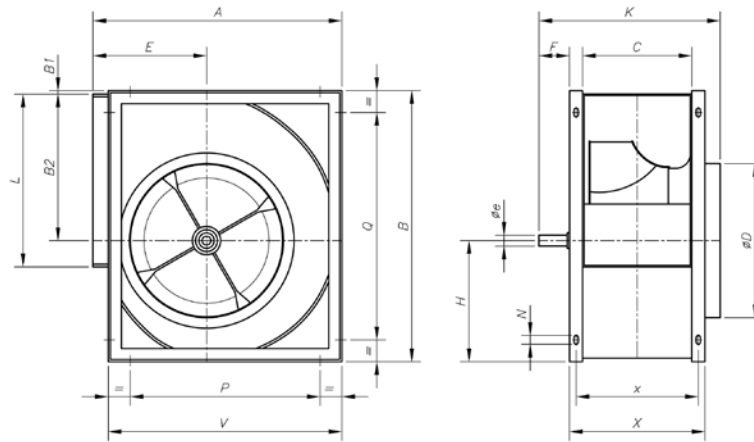

Modelo	A	B	B1	B2	C	øD	øe	E	F	H	K	L	N	P	Q	V	X	x
CSXR-315	518	578	3	340	223	322	25	236	83	235	395	404	13x18	280	280	480	283	253
CSXR-355	578	655	6	383	247	362	30	261	78	266	425	453	13x18	355	355	548	327	287
CSXR-400	651	736	4,5	431,5	274	404	30	290	78	300	452	507	13x18	355	355	613	354	314
CSXR-450	726	827	5	486	308	448	35	322	92	336	500	569	13x18	530	530	681	388	348
CSXR-500	800	918	5	538	344	510	35	352	92	375	535	638	13x18	530	530	750	424	394
CSXR-560	893	1030	8	602	383	570	40	390	87	420	600	715	13x18	530	530	845	483	433
CSXR-630	999	1157	7	678,5	432	635	45	434	87	471,5	650	801	13x18	530	530	946	532	482
CSXR-710	1121	1303	7	765	478	722	50	485	115	531	725	898	17x22	630	630	1058	578	528

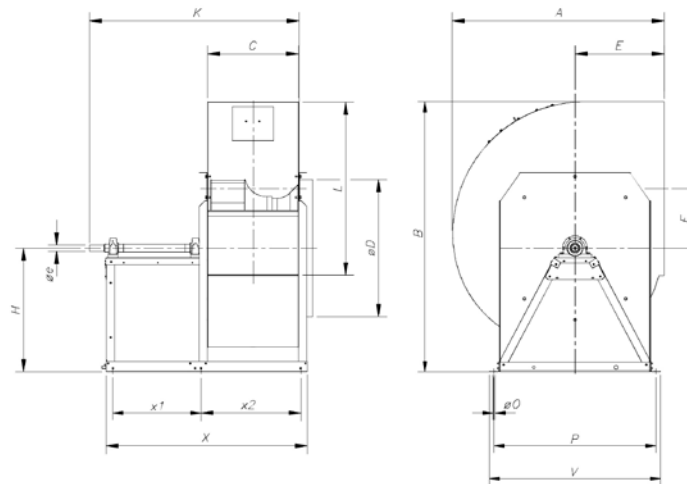

Modelo	A	B	C	L	øD	H	øe	E	F	K	X	ø0	P	V	x1	x2
CSXR-800	1250	1615,5	533	1010	798	762	42	535	358,5	1291,5	1231,5	14	980	1050	515	614
CSXR-900	1408	1475	595	1130	898	850	48	604	407	1353,5	1293,5	14	1080	1150	515	676
CSXR-1000	1541	1966	663	1260	998	900	48	651	433	1529,5	1468,5	14	1180	1250	642	729,5

Dimensiones mm

CSXRT

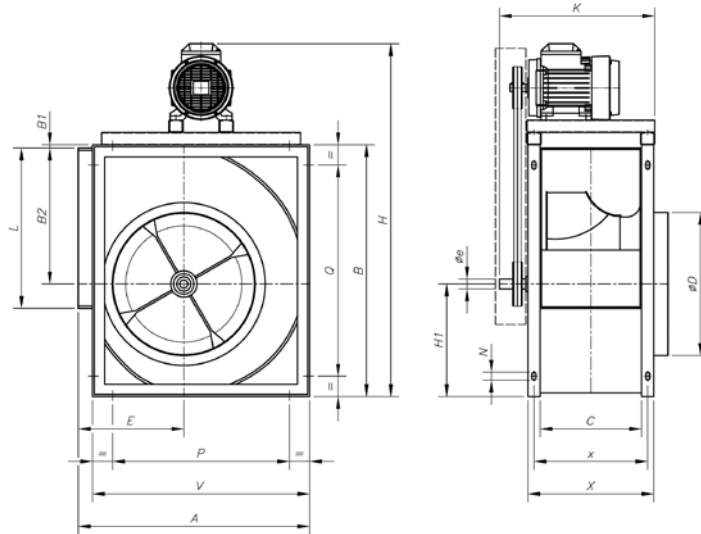

Modelo	A	B	B1	B2	C	øD	øe	E	H	H1	K	L	N	P	Q	V	X	x
CSXRT-315-0'75	518	578	3	340	223	322	25	236	835	235	395	404	13x18	280	280	480	283	253
CSXRT-315-1	518	578	3	340	223	322	25	236	855	235	395	404	13x19	280	280	480	283	253
CSXRT-315-1'5	518	578	3	340	223	322	25	236	855	235	395	404	13x20	280	280	480	283	253
CSXRT-315-2	518	578	3	340	223	322	25	236	875	235	395	404	13x21	280	280	480	283	253
CSXRT-315-3	518	578	3	340	223	322	25	236	875	235	395	404	13x22	280	280	480	283	253
CSXRT-355-0'75	578	655	6	383	247	362	30	261	910	266	425	453	13x18	355	355	548	327	287
CSXRT-355-1	578	655	6	383	247	362	30	261	930	266	425	453	13x19	355	355	548	327	287
CSXRT-355-1'5	578	655	6	383	247	362	30	261	930	266	425	453	13x20	355	355	548	327	287
CSXRT-355-2	578	655	6	383	247	362	30	261	945	266	425	453	13x21	355	355	548	327	287
CSXRT-355-3	578	655	6	383	247	362	30	261	945	266	425	453	13x22	355	355	548	327	287
CSXRT-355-4	578	655	6	383	247	362	30	261	963	266	425	453	13x23	355	355	548	327	287
CSXRT-400-0'75	651	736	4,5	431,5	274	404	30	290	1012	300	452	507	13x18	355	355	613	354	314
CSXRT-400-1	651	736	4,5	431,5	274	404	30	290	1012	300	452	507	13x19	355	355	613	354	314
CSXRT-400-1'5	651	736	4,5	431,5	274	404	30	290	1012	300	452	507	13x20	355	355	613	354	314
CSXRT-400-2	651	736	4,5	431,5	274	404	30	290	1033	300	452	507	13x21	355	355	613	354	314
CSXRT-400-3	651	736	4,5	431,5	274	404	30	290	1033	300	452	507	13x22	355	355	613	354	314
CSXRT-400-4	651	736	4,5	431,5	274	404	30	290	1045	300	452	507	13x23	355	355	613	354	314
CSXRT-400-5'5	651	736	4,5	431,5	274	404	30	290	1072	300	452	507	13x24	355	355	613	354	314
CSXRT-450-0'75	726	827	5	486	308	448	35	322	1100	336	500	569	13x18	530	530	681	388	348
CSXRT-450-1	726	827	5	486	308	448	35	322	1100	336	500	569	13x19	530	530	681	388	348
CSXRT-450-1'5	726	827	5	486	308	448	35	322	1120	336	500	569	13x20	530	530	681	388	348
CSXRT-450-2	726	827	5	486	308	448	35	322	1120	336	500	569	13x21	530	530	681	388	348
CSXRT-450-3	726	827	5	486	308	448	35	322	1138	336	500	569	13x22	530	530	681	388	348
CSXRT-450-4	726	827	5	486	308	448	35	322	1138	336	500	569	13x23	530	530	681	388	348
CSXRT-450-5'5	726	827	5	486	308	448	35	322	1162	336	500	569	13x24	530	530	681	388	348
CSXRT-450-7'5	726	827	5	486	308	448	35	322	1205	336	500	569	13x25	530	530	681	388	348
CSXRT-450-10	726	827	5	486	308	448	35	322	1205	336	500	569	13x26	530	530	681	388	348
CSXRT-450-12'5	726	827	5	486	308	448	35	322	1205	336	500	569	13x27	530	530	681	388	348
CSXRT-500-1'5	800	918	5	538	344	510	35	352	1214	375	535	638	13x18	530	530	750	424	394
CSXRT-500-2	800	918	5	538	344	510	35	352	1214	375	535	638	13x19	530	530	750	424	394
CSXRT-500-3	800	918	5	538	344	510	35	352	1228	375	535	638	13x20	530	530	750	424	394
CSXRT-500-4	800	918	5	538	344	510	35	352	1228	375	535	638	13x21	530	530	750	424	394
CSXRT-500-5'5	800	918	5	538	344	510	35	352	1255	375	535	638	13x22	530	530	750	424	394
CSXRT-500-7'5	800	918	5	538	344	510	35	352	1292	375	535	638	13x23	530	530	750	424	394
CSXRT-500-10	800	918	5	538	344	510	35	352	1292	375	535	638	13x24	530	530	750	424	394
CSXRT-500-12'5	800	918	5	538	344	510	35	352	1292	375	535	638	13x25	530	530	750	424	394
CSXRT-500-15	800	918	5	538	344	510	35	352	1350	375	535	638	13x26	530	530	750	424	394
CSXRT-560-2	893	1030	8	602	383	570	40	390	1325	420	600	715	13x18	530	530	845	483	433

Dimensiones mm

Modelo	A	B	B1	B2	C	øD	øe	E	H	H1	K	L	N	P	Q	V	X	x
CSXRT-560-3	893	1030	8	602	383	570	40	390	1340	420	600	715	13x19	530	530	845	483	433
CSXRT-560-4	893	1030	8	602	383	570	40	390	1340	420	600	715	13x20	530	530	845	483	433
CSXRT-560-5'5	893	1030	8	602	383	570	40	390	1365	420	600	715	13x21	530	530	845	483	433
CSXRT-560-7'5	893	1030	8	602	383	570	40	390	1410	420	600	715	13x22	530	530	845	483	433
CSXRT-560-10	893	1030	8	602	383	570	40	390	1410	420	600	715	13x23	530	530	845	483	433
CSXRT-560-12'5	893	1030	8	602	383	570	40	390	1410	420	600	715	13x24	530	530	845	483	433
CSXRT-560-15	893	1030	8	602	383	570	40	390	1464	420	600	715	13x25	530	530	845	483	433
CSXRT-630-3	999	1157	7	678,5	432	635	45	434	1470	471,5	650	801	13x18	530	530	946	532	482
CSXRT-630-4	999	1157	7	678,5	432	635	45	434	1470	471,5	650	801	13x19	530	530	946	532	482
CSXRT-630-5'5	999	1157	7	678,5	432	635	45	434	1492	471,5	650	801	13x20	530	530	946	532	482
CSXRT-630-7'5	999	1157	7	678,5	432	635	45	434	1531	471,5	650	801	13x21	530	530	946	532	482
CSXRT-630-10	999	1157	7	678,5	432	635	45	434	1531	471,5	650	801	13x22	530	530	946	532	482
CSXRT-630-12'5	999	1157	7	678,5	432	635	45	434	1531	471,5	650	801	13x23	530	530	946	532	482
CSXRT-630-15	999	1157	7	678,5	432	635	45	434	1590	471,5	650	801	13x24	530	530	946	532	482
CSXRT-630-20	999	1157	7	678,5	432	635	45	434	1590	471,5	650	801	13x25	530	530	946	532	482
CSXRT-710-4	1121	1303	7	765	478	722	50	485	1612	531	725	898	17x22	630	630	1058	578	528
CSXRT-710-5'5	1121	1303	7	765	478	722	50	485	1638	531	725	898	17x23	630	630	1058	578	528
CSXRT-710-7'5	1121	1303	7	765	478	722	50	485	1675	531	725	898	17x24	630	630	1058	578	528
CSXRT-710-10	1121	1303	7	765	478	722	50	485	1675	531	725	898	17x25	630	630	1058	578	528
CSXRT-710-12'5	1121	1303	7	765	478	722	50	485	1675	531	725	898	17x26	630	630	1058	578	528
CSXRT-710-15	1121	1303	7	765	478	722	50	485	1735	531	725	898	17x27	630	630	1058	578	528
CSXRT-710-20	1121	1303	7	765	478	722	50	485	1735	531	725	898	17x28	630	630	1058	578	528
CSXRT-710-25	1121	1303	7	765	478	722	50	485	1820	531	725	898	17x29	630	630	1058	578	528

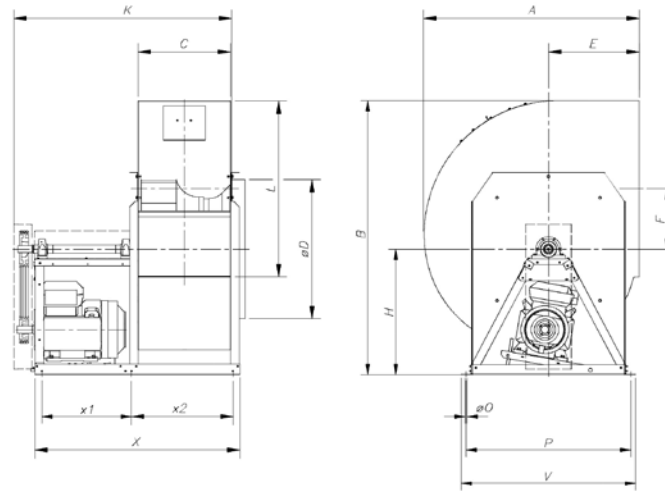

Modelo	A	B	C	L	øD	H	E	F	K	X	øO	P	V	x1	x2
CSXRT-800	1250	1615,5	533	1010	798	762	535	358,5	1321,5	1231,5	14	980	1050	515	614
CSXRT-900	1408	1475	595	1130	898	850	604	407	1383,5	1293,5	14	1080	1150	515	676
CSXRT-1000	1541	1966	663	1260	998	900	651	433	1559,5	1468,5	14	1180	1250	642	729,5

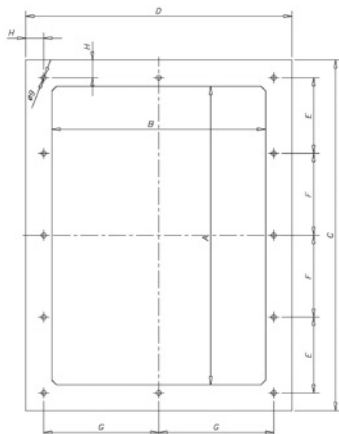

Accesorio brida de impulsión

	A	B	C	D	E	F	G	H
CSXRT-800	1007	533	1063	589	268,5	250	281,5	13
CSXRT-900	1130	595	1186	651	280	300	312,5	13
CSXRT-1000	1267	663	1323	719	298,5	350	346,5	13

Dimensiones mm

CJSXR

Suministro standard impulsión horizontal (H) RD 90

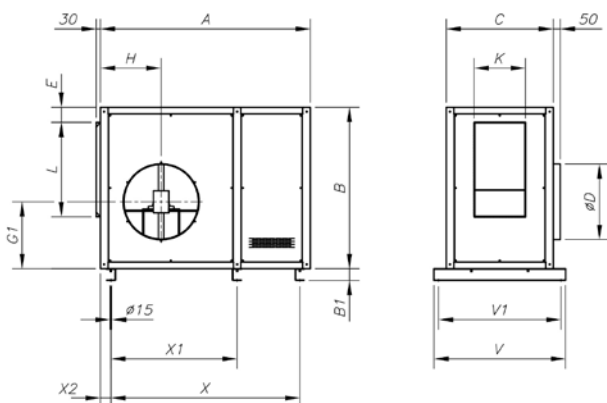

Bajo demanda impulsión horizontal (H) LG 90

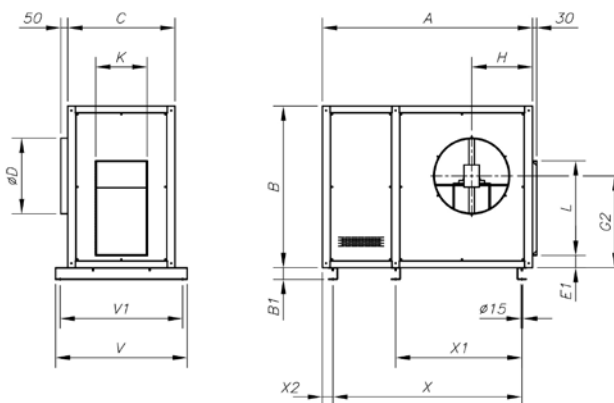

Bajo demanda impulsión vertical (V) RD 0

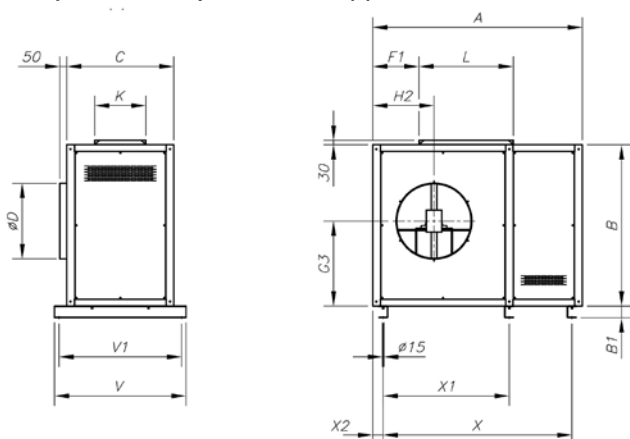

Bajo demanda impulsión vertical (V) LG 0

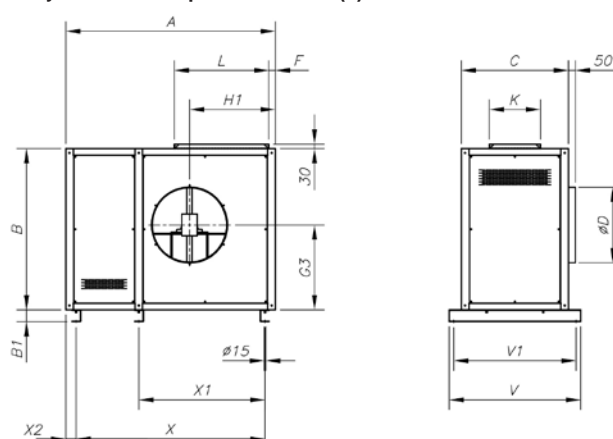

Modelo	A	B	B1	C	ØD	E	E1	F	F1	G1	G2	G3	H	H1	H2	L	K	V	V1	X	X1	X2
CJSXR-315	1170	740	60	600	315	82	84,2	113	281	317,5	423,2	366,2	305	451,5	346,3	405	224	760	680	880	-	155
CJSXR-355	1265	815	60	650	365	85	86,5	112,5	302,5	347,2	470,2	398	338	496	373	454	248	810	730	1020	-	152
CJSXR-400	1370	900	60	680	400	82	90,2	111	331	386,2	522,2	447,2	359	543	407	508	275	840	760	1120	-	152
CJSXR-450	1480	990	60	716	448	82	91,2	112,8	360	422,2	577,2	491	383	598	443	570	309	876	796	1240	-	152
CJSXR-500	1625	1080	60	760	510	80,5	91	111,7	381,3	461,2	629,2	534,2	409	650	482	639	345	920	840	1340	670	152
CJSXR-560	1760	1195	60	810	580	86,8	94,2	128	426	506,2	696,2	590	462	731	540	716	384	970	890	1490	745	152
CJSXR-630	1880	1322	60	850	635	85,2	89,6	113,4	455,6	557,7	768,7	648,2	488	792,5	578,5	802	433	1010	930	820	1610	158
CJSXR-710	2180	1500	80	910	710	103	108,2	100	491	632,2	873,2	737,2	562	865	624	899	479	1070	990	955	1910	168

Curvas características

Q= Caudal en m³/h, m³/s y cfm.

Pe= Presión estática en mmH₂O, Pa e inwg.

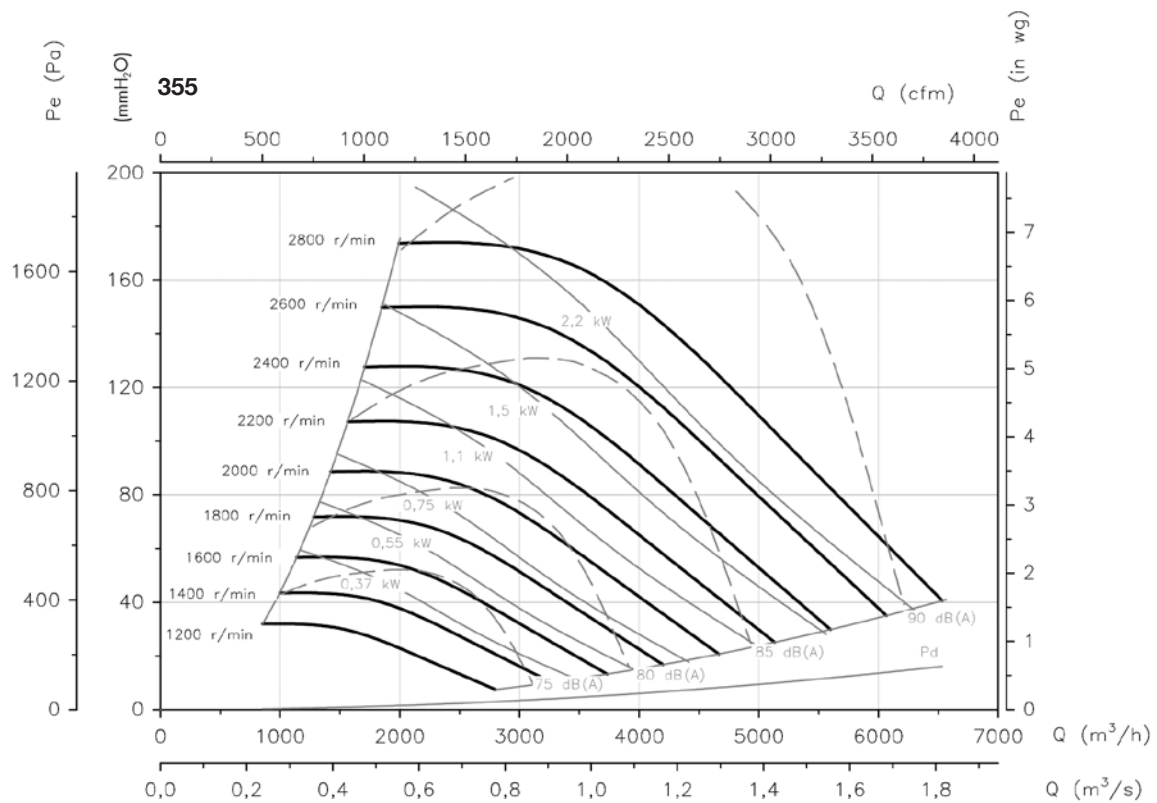
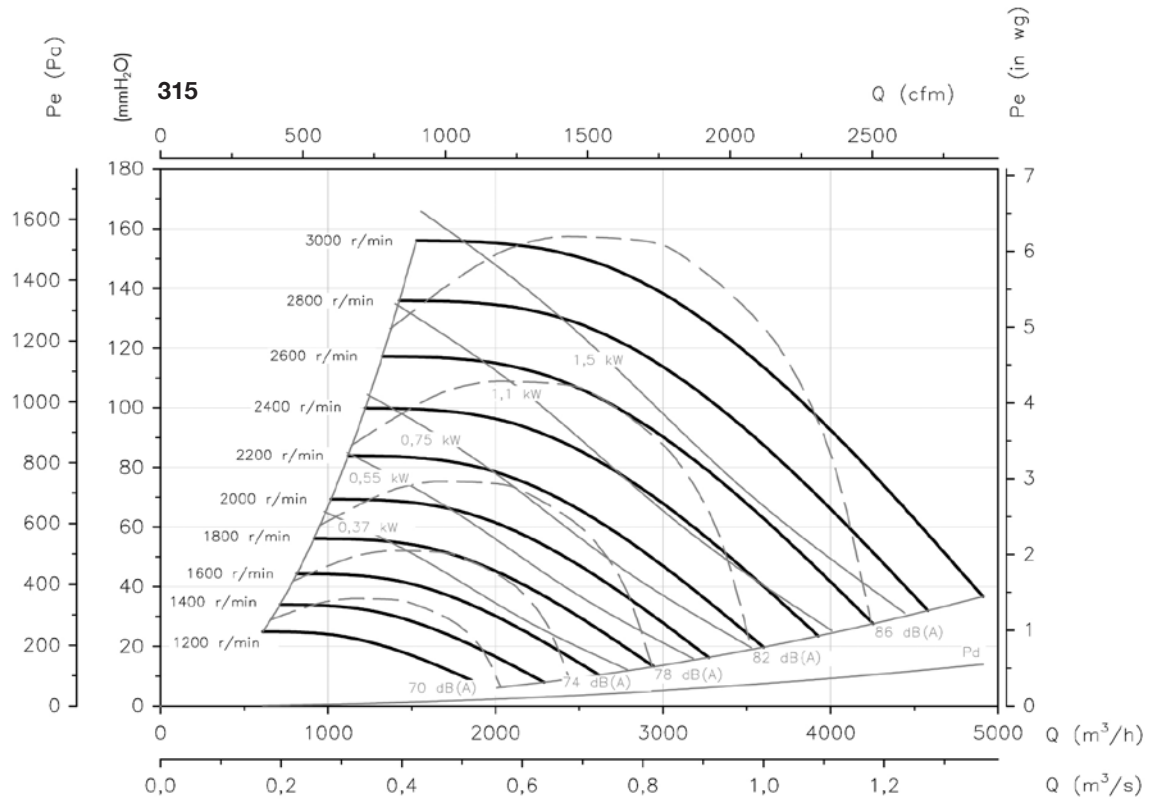

Curvas características

Q= Caudal en m³/h, m³/s y cfm.

Pe= Presión estática en mmH₂O, Pa e inwg.

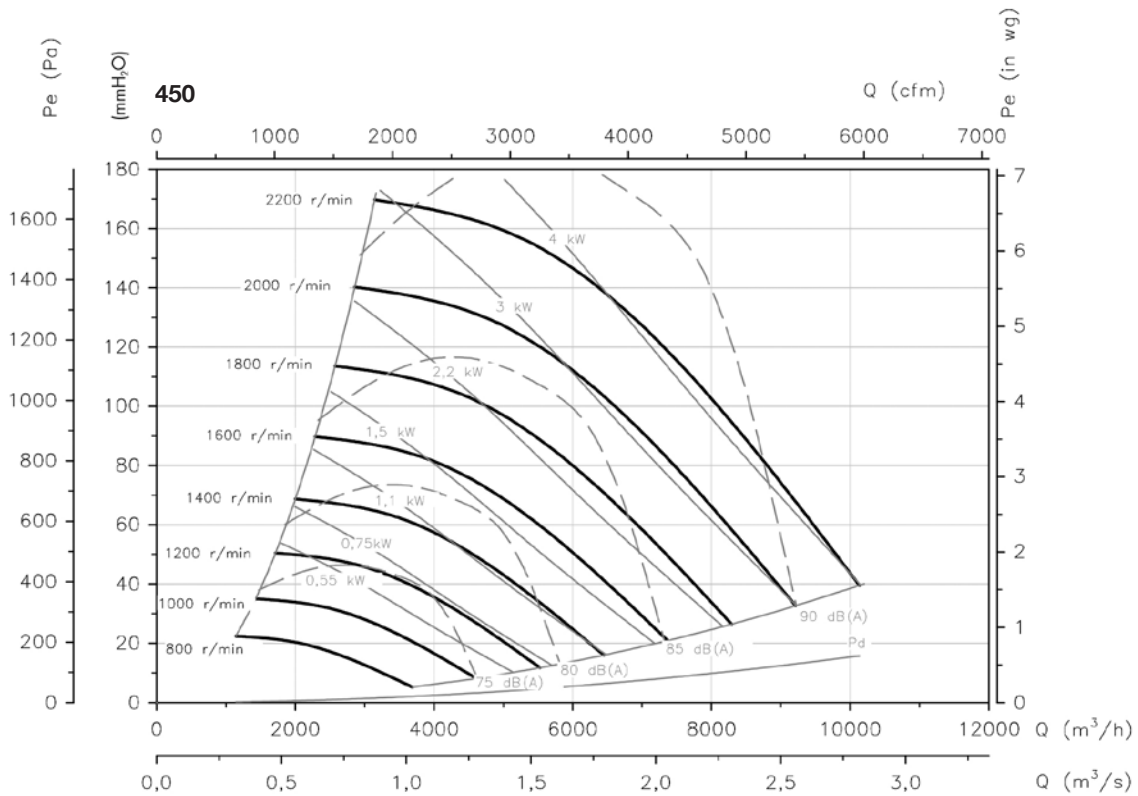
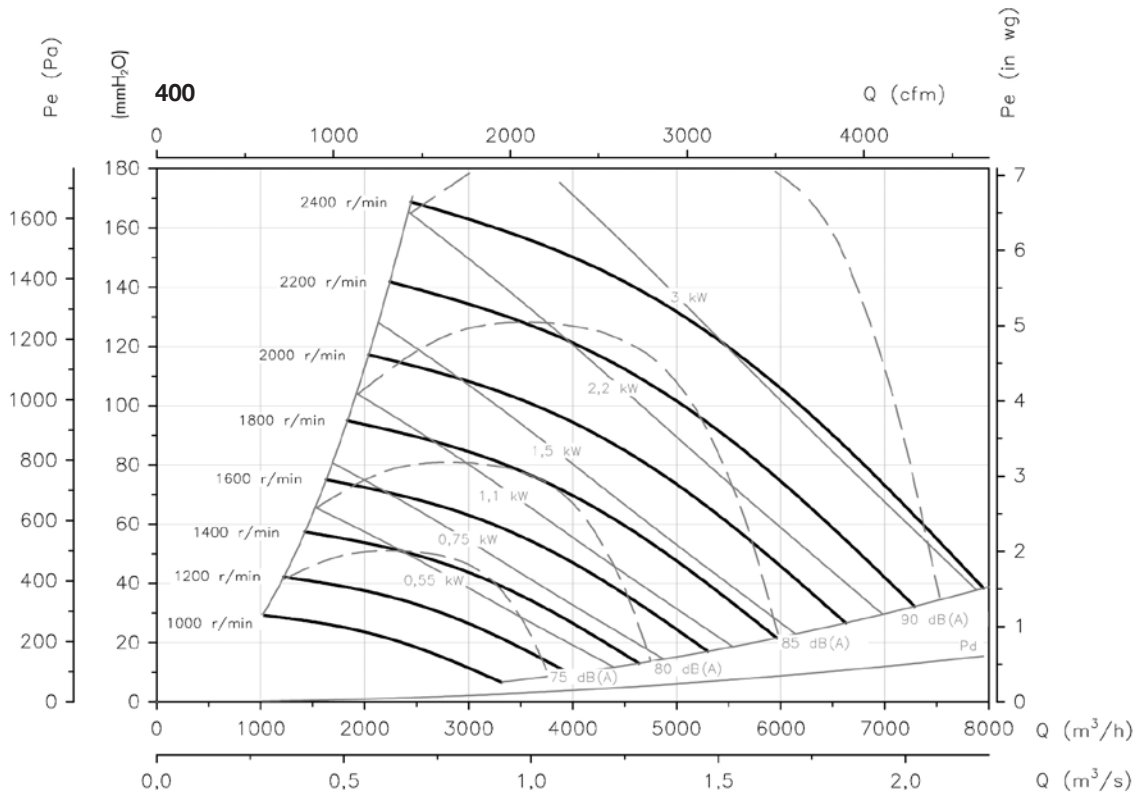

Curvas características

Q= Caudal en m³/h, m³/s y cfm.

Pe= Presión estática en mmH₂O, Pa e inwg.

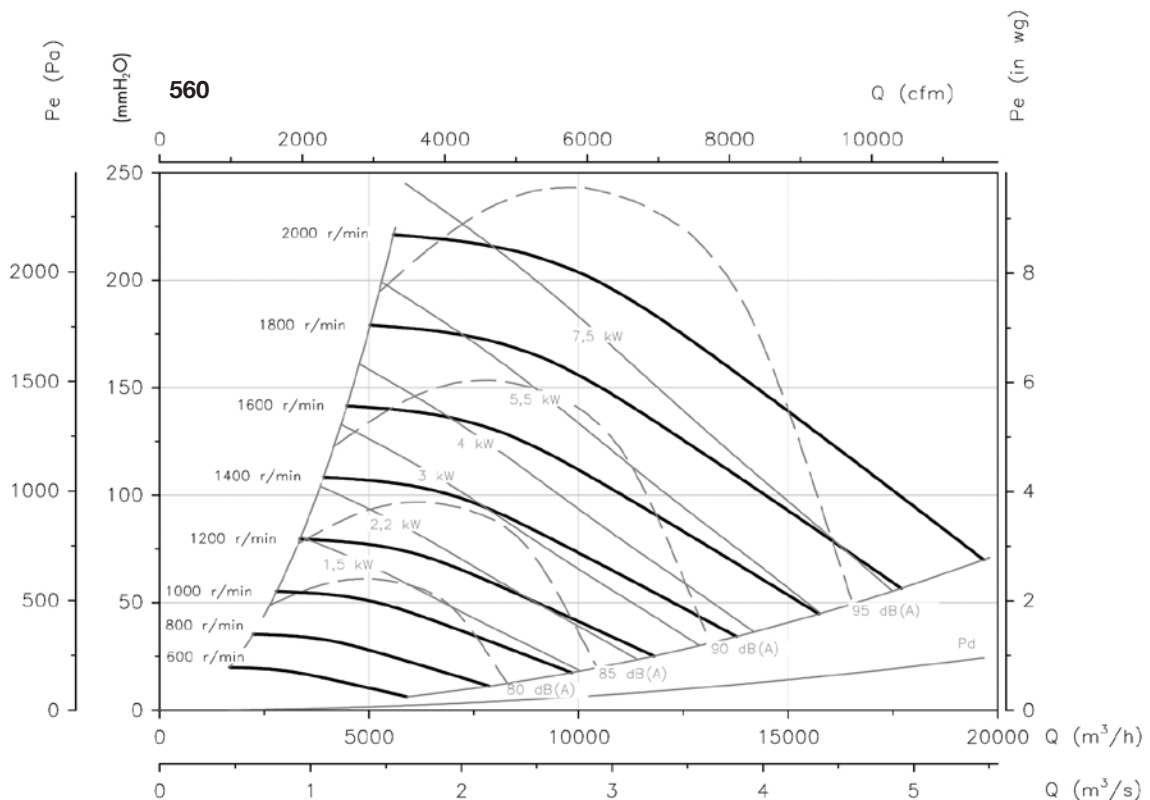
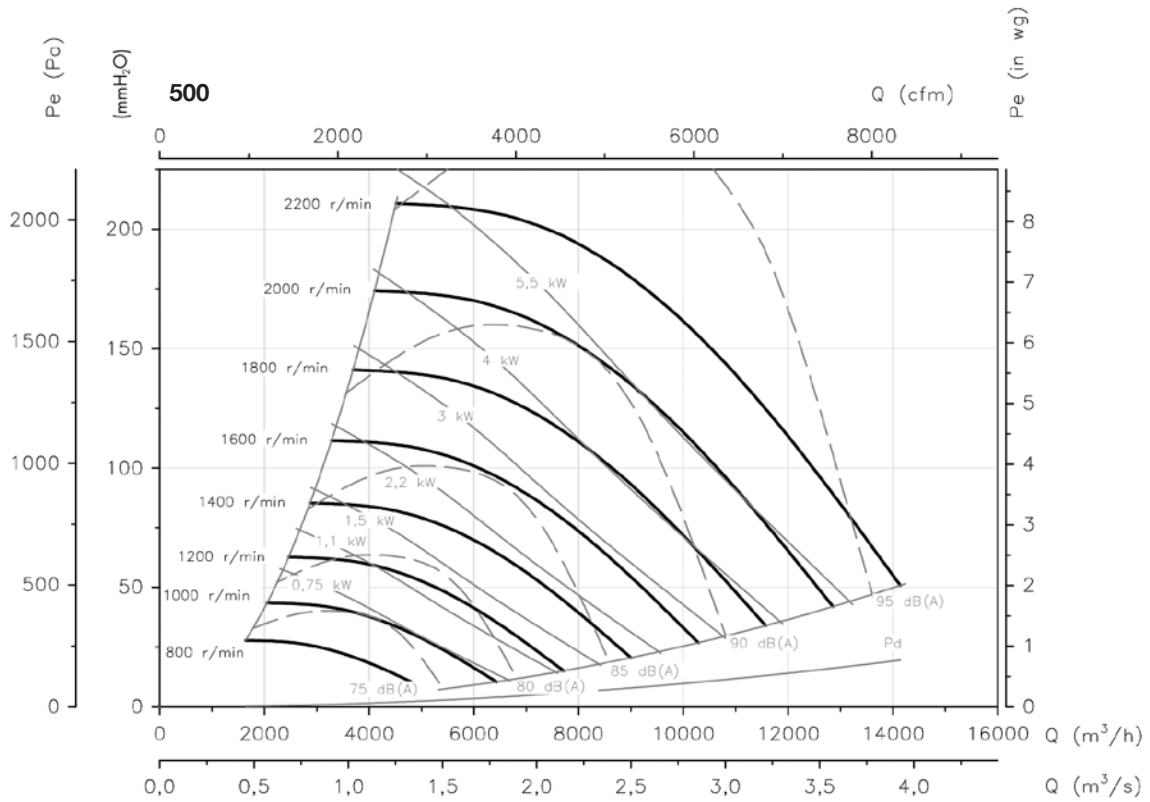

Curvas características

Q= Caudal en m³/h, m³/s y cfm.

Pe= Presión estática en mmH₂O, Pa e inwg.

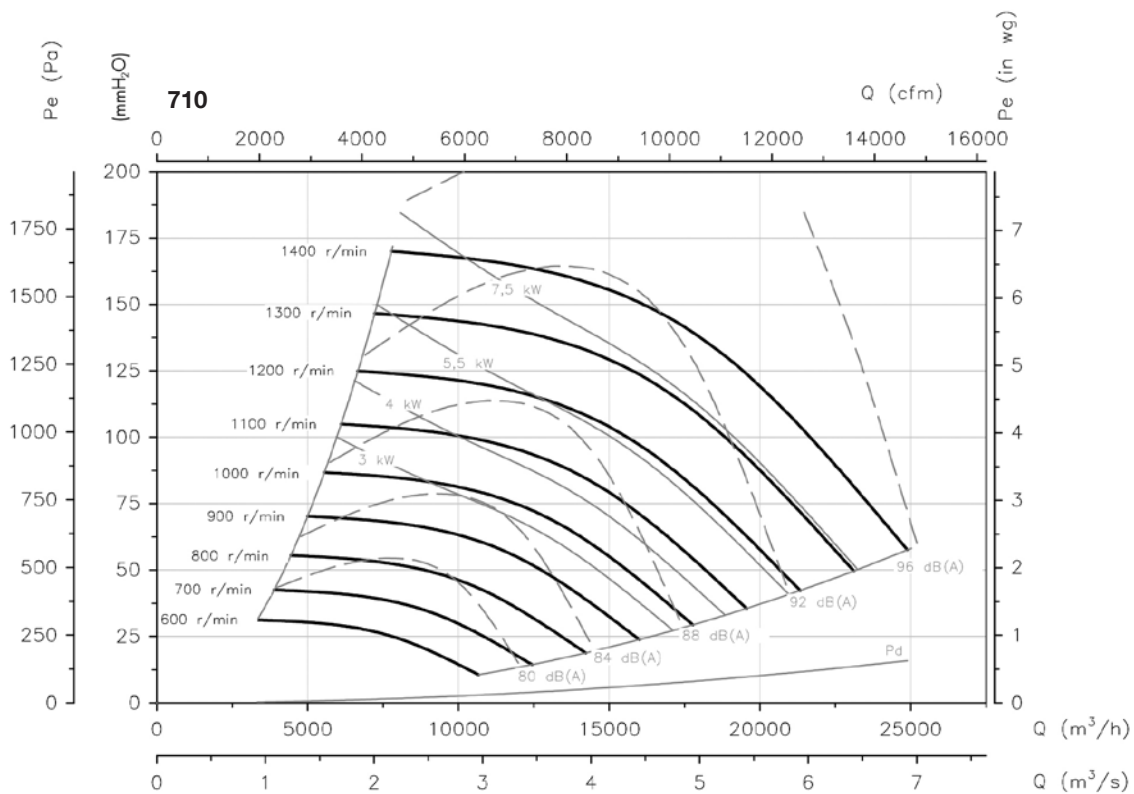
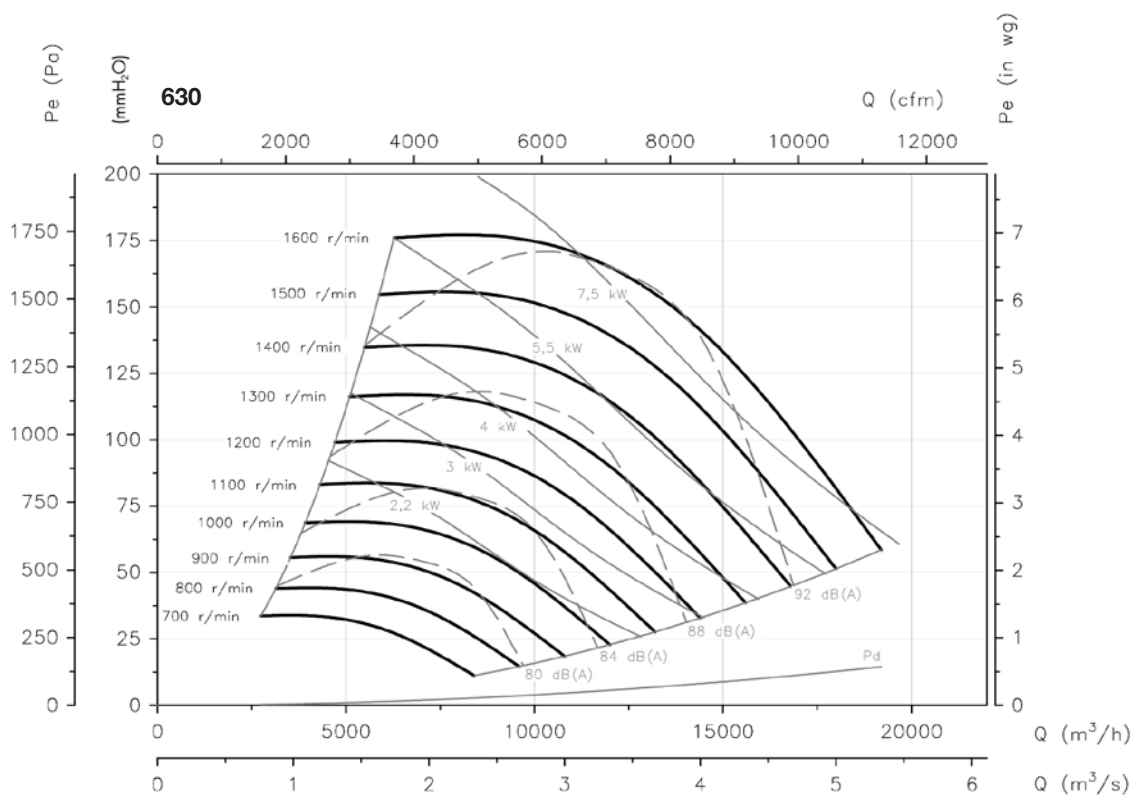

Curvas características

Q= Caudal en m³/h, m³/s y cfm.

Pe= Presión estática en mmH₂O, Pa e inwg.

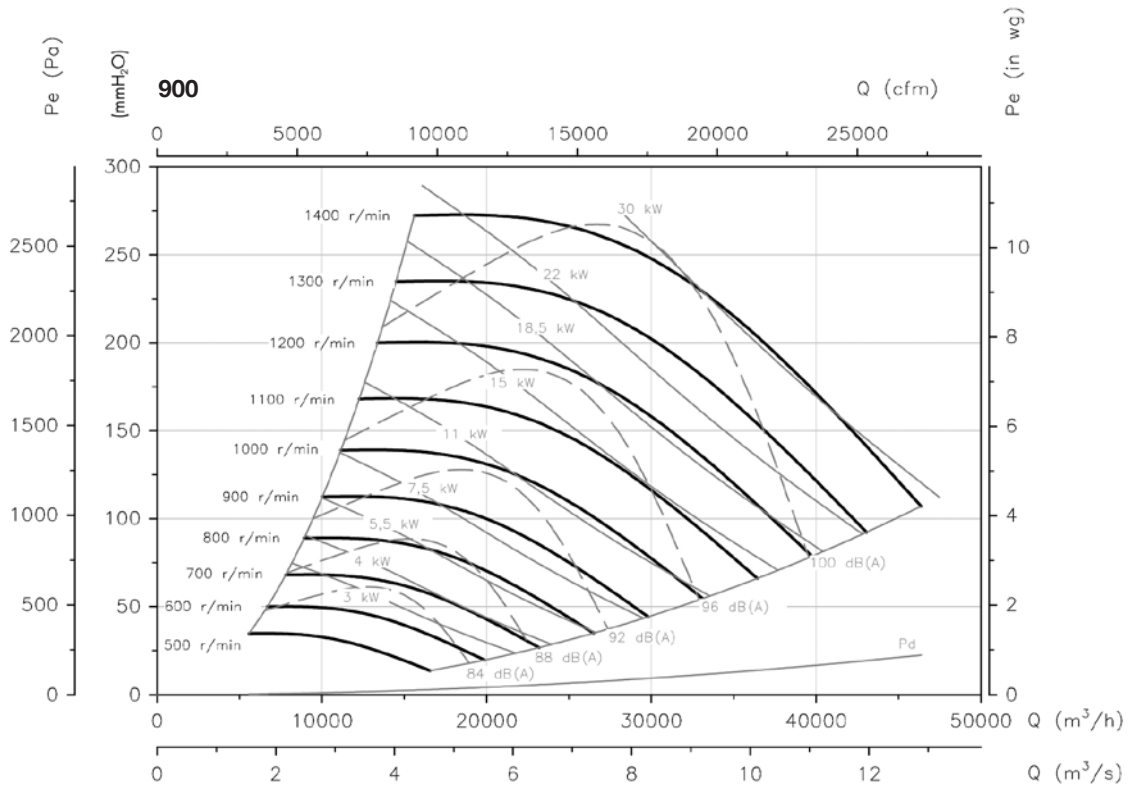
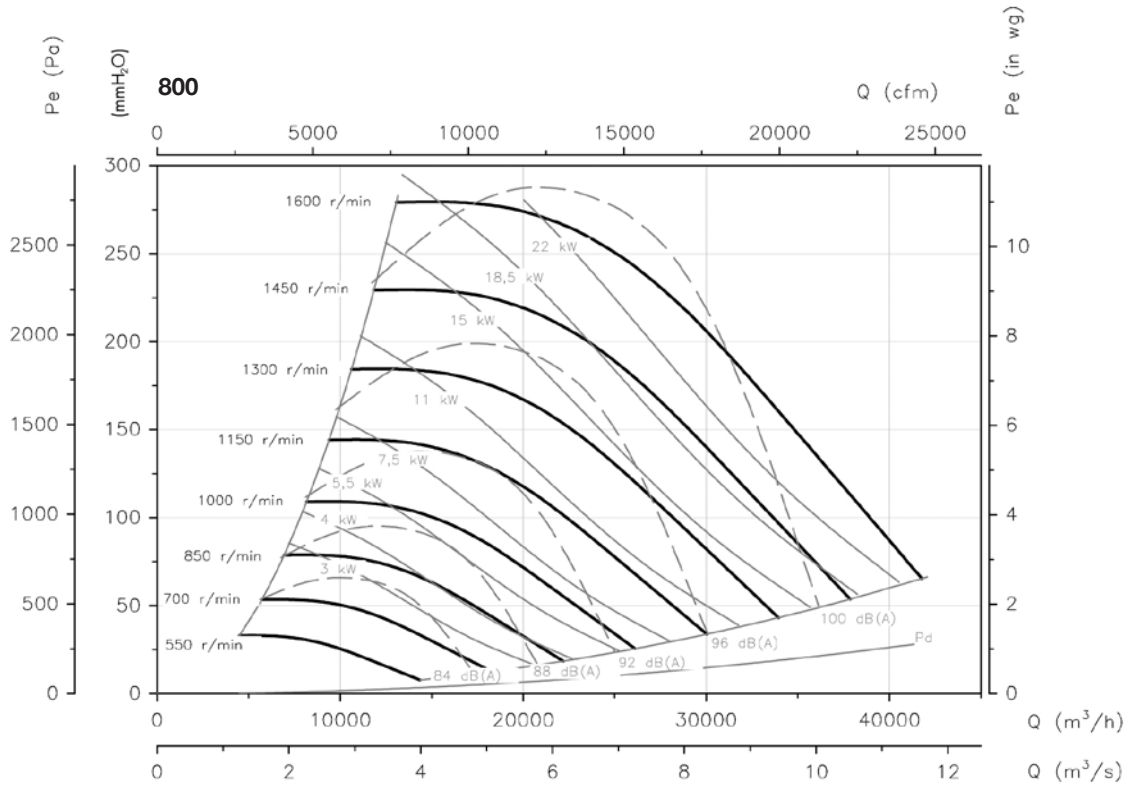

Curvas características

Q= Caudal en m³/h, m³/s y cfm.

Pe= Presión estática en mmH₂O, Pa e inwg.

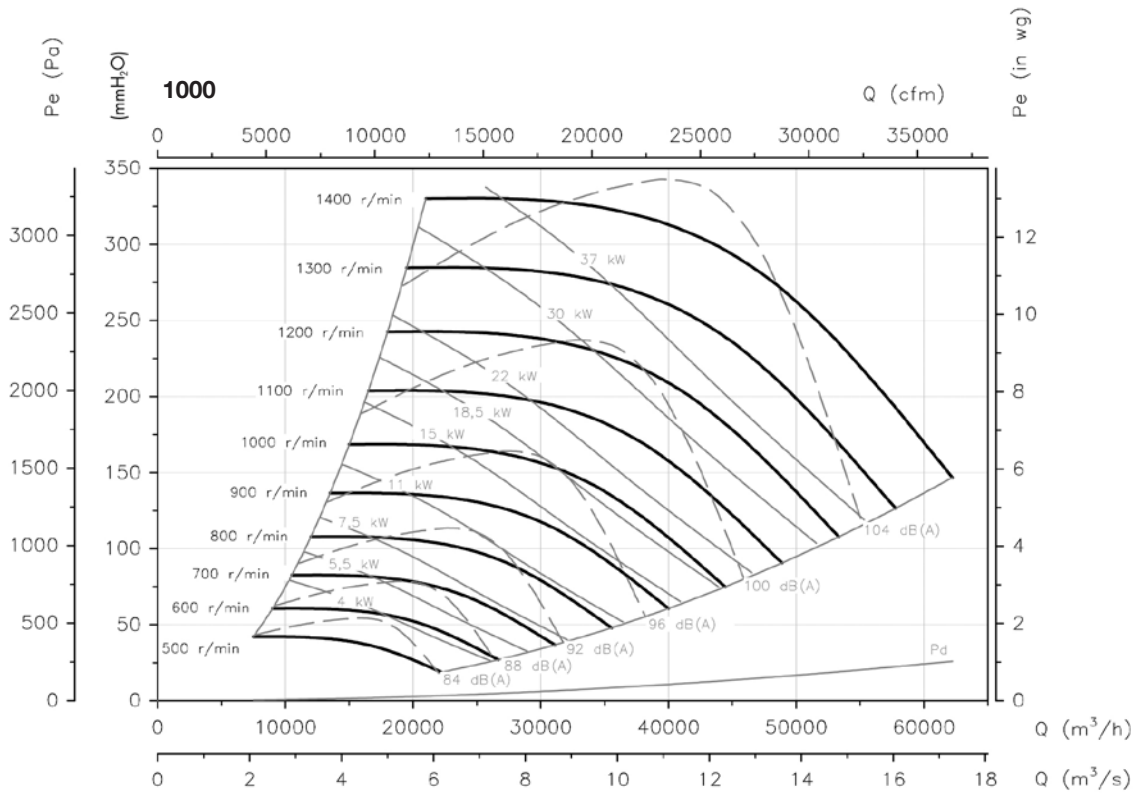

Accesorios



INT

C2V

RM

VSD3/A-RFT

AET

VIS

TEJ

TSA TSAT CJTSA

TSA: Ventiladores centrífugos de simple aspiración a transmisión, con salida de eje y turbina con álabes hacia adelante

TSAT: Ventiladores centrífugos de simple aspiración a transmisión, equipados con motor eléctrico, conjunto de poleas, correas, protectores y turbina con álabes hacia adelante

CJTSA: Unidades de ventilación con turbina de álabes hacia delante aisladas acústicamente, equipadas con ventiladores de la serie TSA, sobre amortiguadores de goma



TSA



TSAT



CJTSA

Ventilador:

- Envolverte en chapa de acero galvanizado
- Turbina con álabes hacia adelante, en chapa de acero galvanizado
- Estructura en chapa de acero galvanizado, con aislamiento térmico y acústico (CJTSA)
- Prensaestopas para entrada de cable (CJTSA)

Motor:

- Motores de eficiencia IE3 para potencias iguales o superiores a 0,75kW, excepto monofásicos, 2 velocidades y 8 polos.
- Motores clase F, con rodamientos a bolas protección IP55
- Motor Multitensión, diseño especial válido para: 220/380V 60Hz, 254/440V 60Hz, 265/460V 60Hz, 277/480V 60Hz
- Temperatura máxima del aire a transportar: -20°C. +60°C.

Acabado:

- Anticorrosivo en chapa de acero galvanizado

Bajo demanda:

- Diferentes posiciones de boca de impulsión
- Bobinados especiales para diferentes tensiones
- Con motores de 2 velocidades

Código de pedido

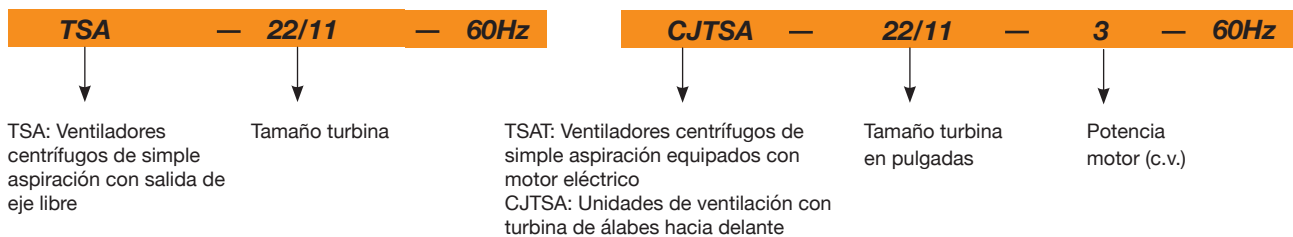

Características técnicas

60Hz

Modelo	Velocidad máx. (r/min)	Máx. Potencia instalada (kW)	Caudal máximo (m³/h)	Temperatura del aire min. (°C)	Temperatura del aire máx. (°C)	Peso aprox. (Kg)
TSA-12/6	1500	2,2	4800	-20	85	17,5
TSA-15/7	1050	3	7400	-20	85	22,5
TSA-18/9	920	4	10500	-20	85	33
TSA-20/10	850	5,5	15000	-20	85	71
TSA-22/11	1000	18,5	26000	-20	85	80
TSA-25/13	810	18,5	32000	-20	85	93
TSA-30/14	600	18,5	38000	-20	85	125

Características técnicas

Modelo	Velocidad (r/min)	Intensidad máx admisible (A)		Potencia instalada (kW)	Caudal máximo (m³/h)	Nivel presión sonora dB(A)	Peso aprox. (Kg)
		220-277V	380-480V				
TSAT CJTSA 12/6-0,75	1000	2,4	1,4	0,55	2600	69	73
TSAT CJTSA 12/6-1	1100	3,3	1,9	0,75	3100	71	74
TSAT CJTSA 12/6-1,5	1250	4,5	2,6	1,1	3500	74	77
TSAT CJTSA 12/6-2	1300	6,0	3,5	1,5	4250	77	80
TSAT CJTSA 12/6-3	1500	8,3	4,8	2,2	4800	79	85
TSAT CJTSA 15/7-1	800	3,3	1,9	0,75	4000	67	92
TSAT CJTSA 15/7-1,5	850	4,5	2,6	1,1	4800	69	95
TSAT CJTSA 15/7-2	920	6,0	3,5	1,5	5400	72	98
TSAT CJTSA 15/7-3	1000	8,3	4,8	2,2	6400	75	103
TSAT CJTSA 15/7-4	1050	11,2	6,5	3	7400	77	106
TSAT CJTSA 18/9-1,5	750	4,5	2,6	1,1	5800	68	111
TSAT CJTSA 18/9-2	790	6,0	3,5	1,5	6600	70	114
TSAT CJTSA 18/9-3	800	8,3	4,8	2,2	8200	74	119
TSAT CJTSA 18/9-4	850	11,2	6,5	3	9000	76	122
TSAT CJTSA 18/9-5,5	920	14,9	8,6	4	10500	78	125
TSAT CJTSA 20/10-2	650	6,0	3,5	1,5	8100	65	203
TSAT CJTSA 20/10-3	690	8,3	4,8	2,2	10100	68	208
TSAT CJTSA 20/10-4	750	11,2	6,5	3	11500	70	211
TSAT CJTSA 20/10-5,5	790	14,9	8,6	4	13100	73	214
TSAT CJTSA 20/10-7,5	850		11,1	5,5	15000	75	227
TSAT CJTSA 22/11-3	580	8,3	4,8	2,2	11200	67	219
TSAT CJTSA 22/11-4	610	11,2	6,5	3	13000	70	222
TSAT CJTSA 22/11-5,5	650	14,9	8,6	4	15000	72	225
TSAT CJTSA 22/11-7,5	690		11,1	5,5	17000	74	238
TSAT CJTSA 22/11-10	750		14,8	7,5	19000	76	246
TSAT CJTSA 22/11-12,5	790		17,8	9,2	21000	78	257
TSAT CJTSA 22/11-15	830		21,5	11	22000	79	273
TSAT CJTSA 22/11-20	910		28,5	15	24500	81	292
TSAT CJTSA 22/11-25	1000		35,0	18,5	26000	83	322
TSAT CJTSA 25/13-4	520	11,2	6,5	3	14000	62	254
TSAT CJTSA 25/13-5,5	550	14,9	8,6	4	17000	65	257
TSAT CJTSA 25/13-7,5	590		11,1	5,5	19500	67	270
TSAT CJTSA 25/13-10	620		14,8	7,5	23000	70	278
TSAT CJTSA 25/13-12,5	650		17,8	9,2	25000	72	289
TSAT CJTSA 25/13-15	690		21,5	11	26500	74	305
TSAT CJTSA 25/13-20	750		28,5	15	29500	75	324
TSAT CJTSA 25/13-25	810		35,0	18,5	32000	77	354
TSAT CJTSA 30/14-5,5	400	14,9	8,6	4	21000	69	331
TSAT CJTSA 30/14-7,5	425		11,1	5,5	24000	72	344
TSAT CJTSA 30/14-10	460		14,8	7,5	27500	74	352
TSAT CJTSA 30/14-12,5	480		17,8	9,2	30000	76	363
TSAT CJTSA 30/14-15	500		21,5	11	33000	77	379
TSAT CJTSA 30/14-20	550		28,5	15	36500	78	398
TSAT CJTSA 30/14-25	600		35,0	18,5	38000	81	428

Dimensiones mm

TSA

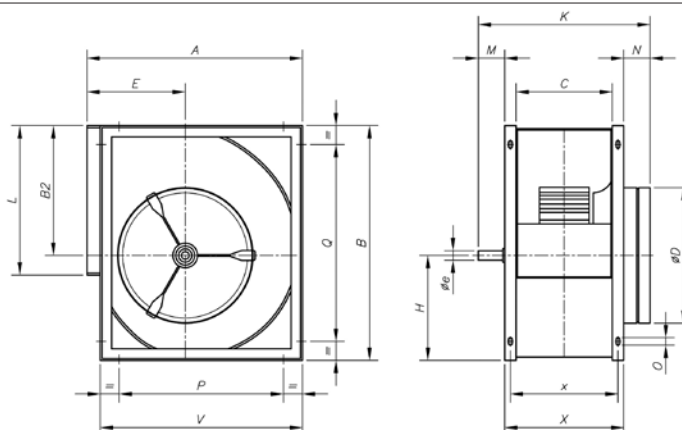

Modelo	A	B	B2	C	øD	E	øe	H	K	L	M	N	O	P	Q	V	X	x
TSA-12/6	498	532	290	210	325	230	25	242	435	345	75	90	9x17	324	324	468	270	242
TSA-15/7	583	632	348	269	400	265	25	284	494	404	75	90	9x17	406	406	553	329	301
TSA-18/9	694	756	415	301	475	323	25	341	526	482	75	90	9x17	520	608	664	361	333

Dimensiones mm

TSA

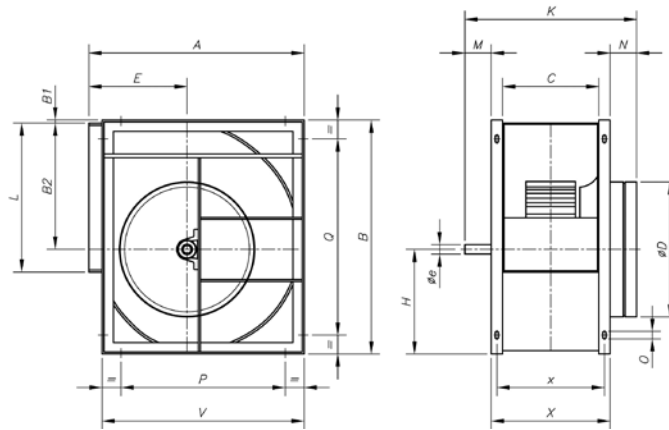

Modelo	A	B	B1	B2	C	øD	E	øe	H	K	L	M	N	O	P	Q	V	X	x
TSA-20/10	843	963	35	523	330	575	375	35	440	620	603	100	110	9x17	646	811	798	410	370
TSA-22/11	913	1046	35	569	358	615	400	35	477	648	693	100	110	9x17	716	894	868	438	398
TSA-25/13	998	1161	35	642	412	695	423	35	519	701	793	100	110	9x17	801	1009	953	492	452
TSA-30/14	1206	1400	35	776	474	835	515	40	624	764	933	100	110	9x17	1009	1248	1161	554	514

TSAT

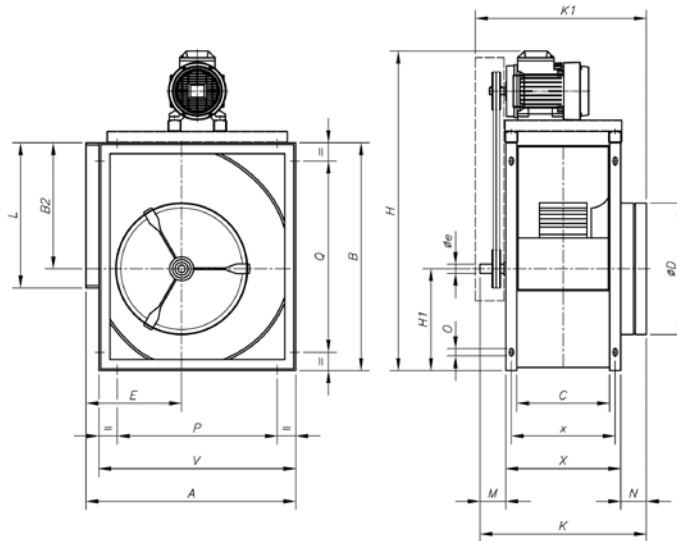

Modelo	A	B	B2	C	øD	E	øe	H	H1	K	K1	L	M	N	O	P	Q	V	X	x
TSAT-12/6-0'75	498	532	290	210	325	230	25	805	242	435	475	345	75	90	9x17	324	324	468	270	242
TSAT-12/6-1	498	532	290	210	325	230	25	805	242	435	475	345	75	90	9x17	324	324	468	270	242
TSAT-12/6-1'5	498	532	290	210	325	230	25	825	242	435	475	345	75	90	9x17	324	324	468	270	242
TSAT-12/6-2	498	532	290	210	325	230	25	825	242	435	475	345	75	90	9x17	324	324	468	270	242
TSAT-12/6-3	498	532	290	210	325	230	25	845	242	435	475	345	75	90	9x17	324	324	468	270	242
TSAT-15/7-1	583	632	348	269	400	265	25	905	284	494	535	404	75	90	9x17	406	406	553	329	301
TSAT-15/7-1'5	583	632	348	269	400	265	25	925	284	494	535	404	75	90	9x17	406	406	553	329	301
TSAT-15/7-2	583	632	348	269	400	265	25	925	284	494	535	404	75	90	9x17	406	406	553	329	301
TSAT-15/7-3	583	632	348	269	400	265	25	945	284	494	535	404	75	90	9x17	406	406	553	329	301
TSAT-15/7-4	583	632	348	269	400	265	25	945	284	494	535	404	75	90	9x17	406	406	553	329	301
TSAT-18/9-1'5	694	756	415	301	475	323	25	1050	341	526	566	482	75	90	9x17	520	608	664	361	333
TSAT-18/9-2	694	756	415	301	475	323	25	1050	341	526	566	482	75	90	9x17	520	608	664	361	333
TSAT-18/9-3	694	756	415	301	475	323	25	1070	341	526	566	482	75	90	9x17	520	608	664	361	333
TSAT-18/9-4	694	756	415	301	475	323	25	1070	341	526	566	482	75	90	9x17	520	608	664	361	333
TSAT-18/9-5'5	694	756	415	301	475	323	25	1095	341	526	566	482	75	90	9x17	520	608	664	361	333

Dimensiones mm

TSAT

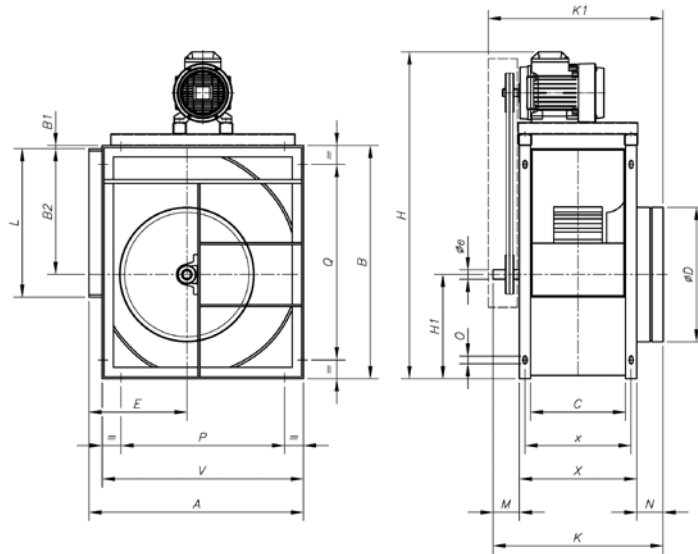

Modelo	A	B	B1	B2	C	øD	E	øe	H	H1	K	K1	L	M	N	O	P	Q	V	X	x
TSAT-20/10-2	843	963	35	523	330	575	375	35	1255	440	620	670	603	100	110	9x17	646	811	798	410	370
TSAT-20/10-3	843	963	35	523	330	575	375	35	1275	440	620	670	603	100	110	9x17	646	811	798	410	370
TSAT-20/10-4	843	963	35	523	330	575	375	35	1275	440	620	670	603	100	110	9x17	646	811	798	410	370
TSAT-20/10-5'5	843	963	35	523	330	575	375	35	1300	440	620	670	603	100	110	9x17	646	811	798	410	370
TSAT-20/10-7'5	843	963	35	523	330	575	375	35	1340	440	620	670	603	100	110	9x17	646	811	798	410	370
TSAT-22/11-3	913	1046	35	569	358	615	400	35	1355	477	648	700	693	100	110	9x17	716	894	868	438	398
TSAT-22/11-4	913	1046	35	569	358	615	400	35	1355	477	648	700	693	100	110	9x17	716	894	868	438	398
TSAT-22/11-5'5	913	1046	35	569	358	615	400	35	1280	477	648	700	693	100	110	9x17	716	894	868	438	398
TSAT-22/11-7'5	913	1046	35	569	358	615	400	35	1420	477	648	700	693	100	110	9x17	716	894	868	438	398
TSAT-22/11-10	913	1046	35	569	358	615	400	35	1420	477	648	700	693	100	110	9x17	716	894	868	438	398
TSAT-22/11-12'5	913	1046	35	569	358	615	400	35	1420	477	648	700	693	100	110	9x17	716	894	868	438	398
TSAT-22/11-15	913	1046	35	569	358	615	400	35	1480	477	648	700	693	100	110	9x17	716	894	868	438	398
TSAT-22/11-20	913	1046	35	569	358	615	400	35	1480	477	648	700	693	100	110	9x17	716	894	868	438	398
TSAT-22/11-25	913	1046	35	569	358	615	400	35	1565	477	648	700	693	100	110	9x17	716	894	868	438	398
TSAT-25/13-4	998	1161	35	642	412	695	423	35	1470	519	701	750	793	100	110	9x17	801	1009	953	492	452
TSAT-25/13-5'5	998	1161	35	642	412	695	423	35	1495	519	701	750	793	100	110	9x17	801	1009	953	492	452
TSAT-25/13-7'5	998	1161	35	642	412	695	423	35	1540	519	701	750	793	100	110	9x17	801	1009	953	492	452
TSAT-25/13-10	998	1161	35	642	412	695	423	35	1540	519	701	750	793	100	110	9x17	801	1009	953	492	452
TSAT-25/13-12'5	998	1161	35	642	412	695	423	35	1540	519	701	750	793	100	110	9x17	801	1009	953	492	452
TSAT-25/13-15	998	1161	35	642	412	695	423	35	1565	519	701	750	793	100	110	9x17	801	1009	953	492	452
TSAT-25/13-20	998	1161	35	642	412	695	423	35	1565	519	701	750	793	100	110	9x17	801	1009	953	492	452
TSAT-25/13-25	998	1161	35	642	412	695	423	35	1680	519	701	750	793	100	110	9x17	801	1009	953	492	452
TSAT-30/14-5'5	1206	1400	35	776	474	835	515	40	1735	624	764	815	933	100	110	9x17	1009	1248	1161	554	514
TSAT-30/14-7'5	1206	1400	35	776	474	835	515	40	1775	624	764	815	933	100	110	9x17	1009	1248	1161	554	514
TSAT-30/14-10	1206	1400	35	776	474	835	515	40	1775	624	764	815	933	100	110	9x17	1009	1248	1161	554	514
TSAT-30/14-12'5	1206	1400	35	776	474	835	515	40	1775	624	764	815	933	100	110	9x17	1009	1248	1161	554	514
TSAT-30/14-15	1206	1400	35	776	474	835	515	40	1835	624	764	815	933	100	110	9x17	1009	1248	1161	554	514
TSAT-30/14-20	1206	1400	35	776	474	835	515	40	1835	624	764	815	933	100	110	9x17	1009	1248	1161	554	514
TSAT-30/14-25	1206	1400	35	776	474	835	515	40	1925	624	764	815	933	100	110	9x17	1009	1248	1161	554	514

Dimensiones mm

CJTSA

Suministro standard impulsión horizontal (H) RD-90

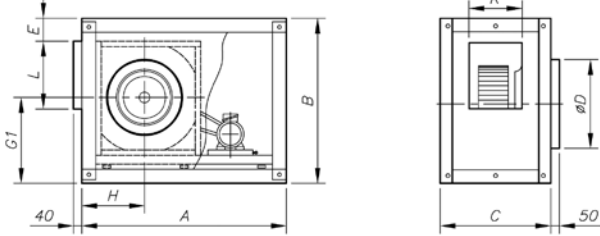

Bajo demanda impulsión vertical (V) RD-0

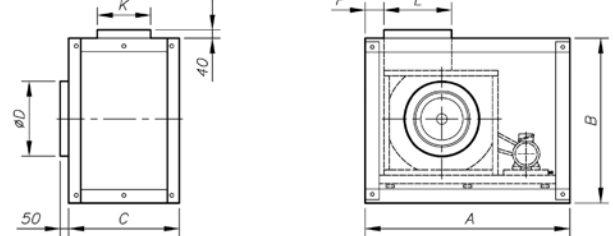

Bajo demanda impulsión horizontal (H) LG-90

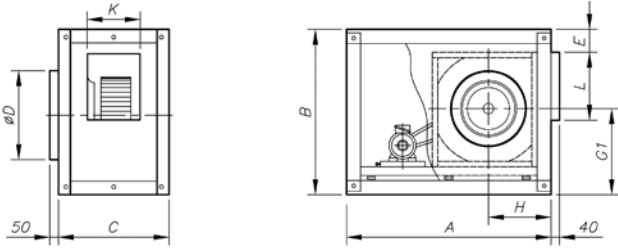

Bajo demanda impulsión vertical (V) LG-0

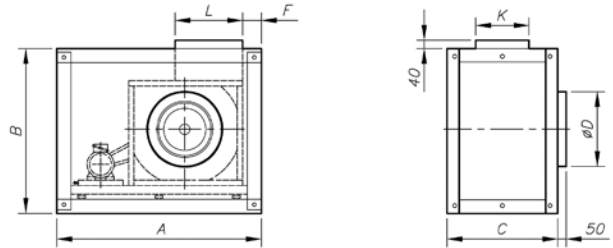

Modelo	A	B	C	ØD	E	E	F	G1	G1	H	L	L	K
CJTSA-12/6-H	850	650	540	330	74	-	-	288	-	288	346	-	210
CJTSA-12/6-V	850	650	540	330	-	-	30	318	-	328	346	-	210
CJTSA-15/7-H	1000	755	600	400	74	-	-	328	-	328	411	-	270
CJTSA-15/7-V	1000	755	600	400	-	-	30	378	-	383	411	-	270
CJTSA-18/9-H	1200	875	620	480	74	-	-	383	-	388	491	-	305
CJTSA-18/9-V	1200	875	620	480	-	-	30	433	-	448	491	-	305
CJTSA-20/10-H	1485	1175	730	565	175	120	-	475	530	440	613	605	343
CJTSA-20/10-V	1485	1175	730	565	-	-	75	535	-	585	613	-	343
CJTSA-22/11-H	1570	1250	760	615	165	110	-	510	565	470	708	700	373
CJTSA-22/11-V	1570	1250	760	615	-	-	75	570	-	640	708	-	373
CJTSA-25/13-H	1610	1375	820	685	175	120	-	550	605	495	803	795	423
CJTSA-25/13-V	1610	1375	820	685	-	-	75	625	-	705	803	-	423
CJTSA-30/14-H	1845	1600	855	820	160	95	-	655	710	580	943	935	488
CJTSA-30/14-V	1845	1600	855	820	-	-	75	760	-	825	943	-	488

Curvas características

Q= Caudal en m³/h, m³/s y cfm.

Pe= Presión estática en mmH²O, Pa e inwg.

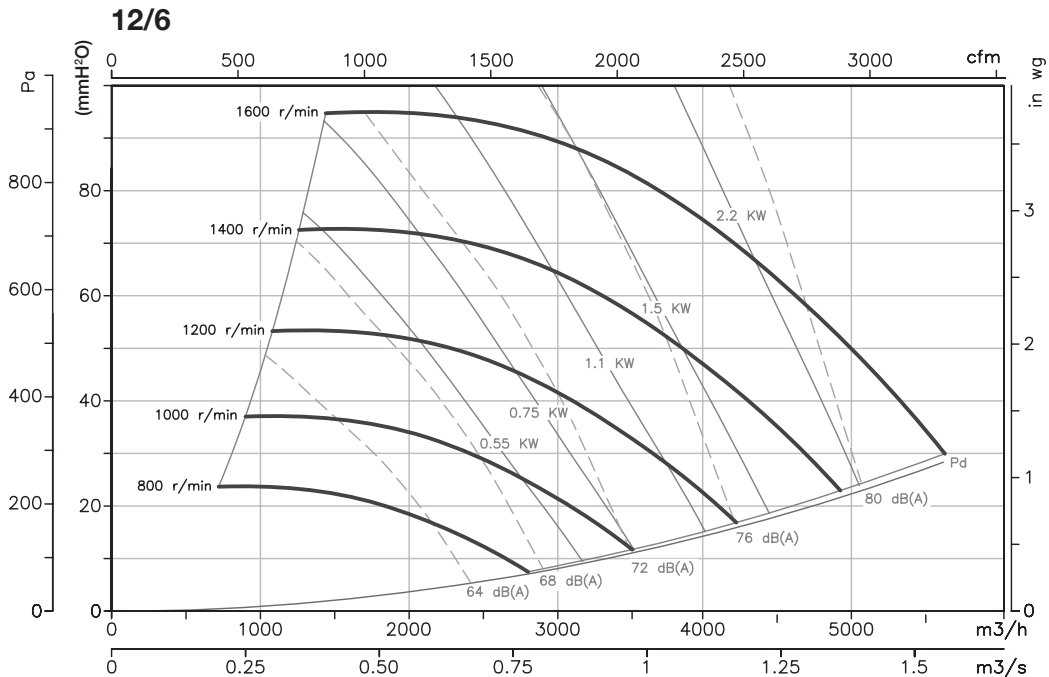

Curvas características

Q= Caudal en m³/h, m³/s y cfm.

Pe= Presión estática en mmH₂O, Pa e inwg.

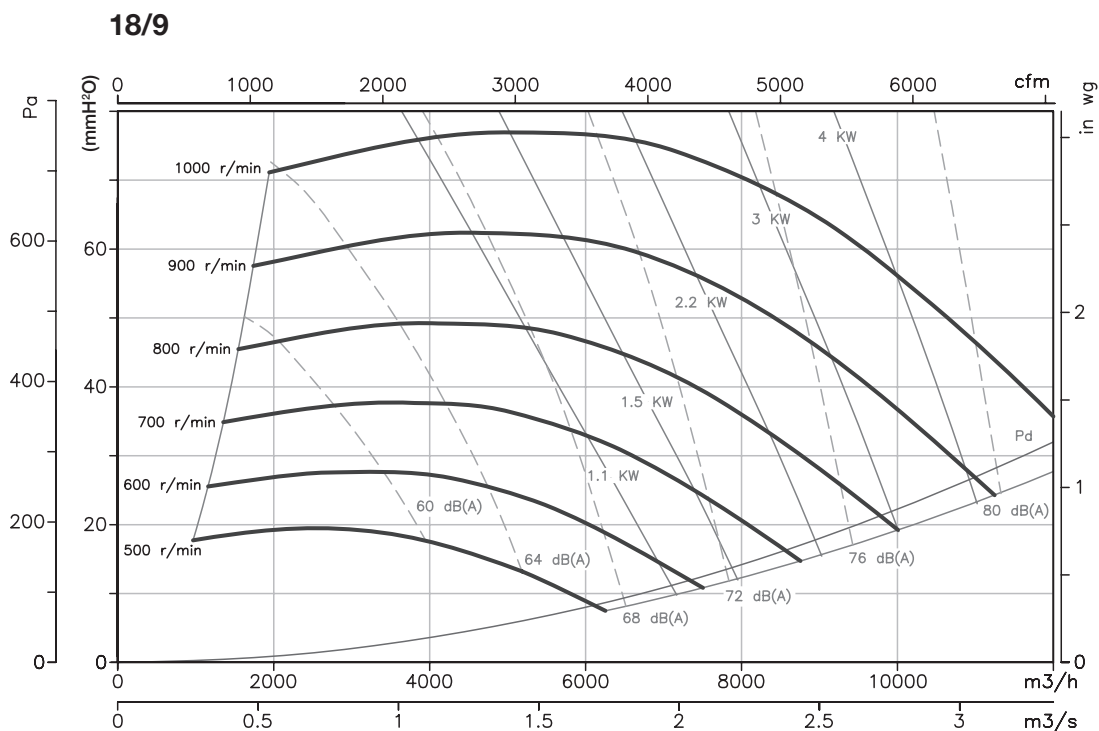
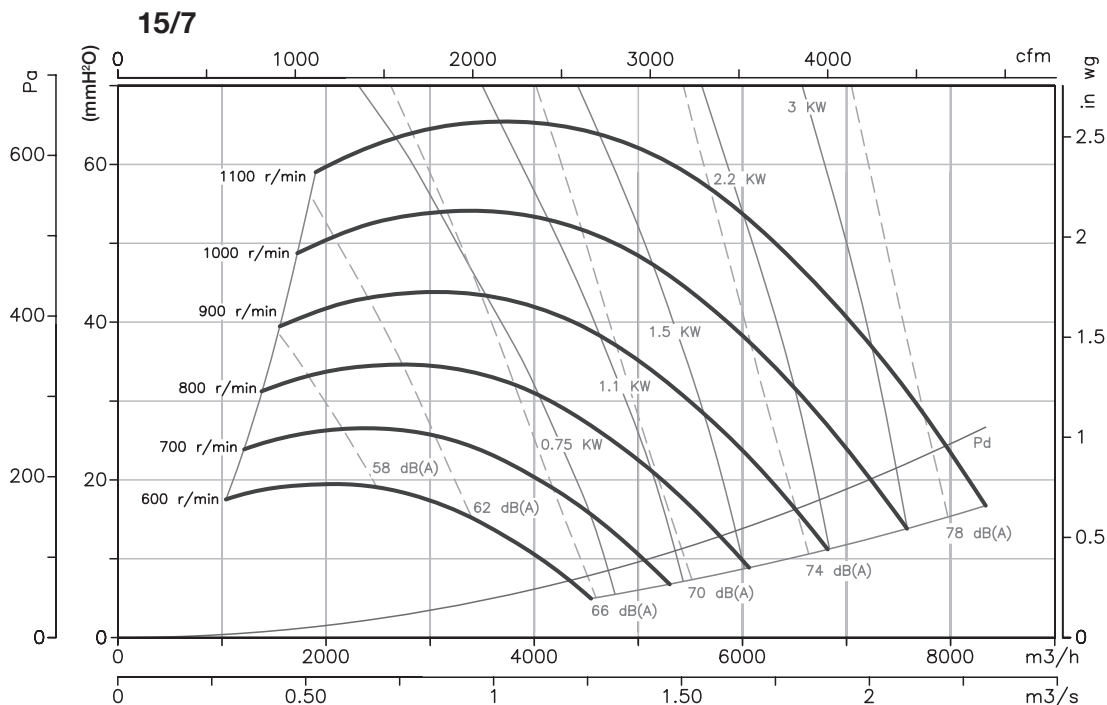

Curvas características

Q= Caudal en m³/h, m³/s y cfm.

Pe= Presión estática en mmH²O, Pa e inwg.

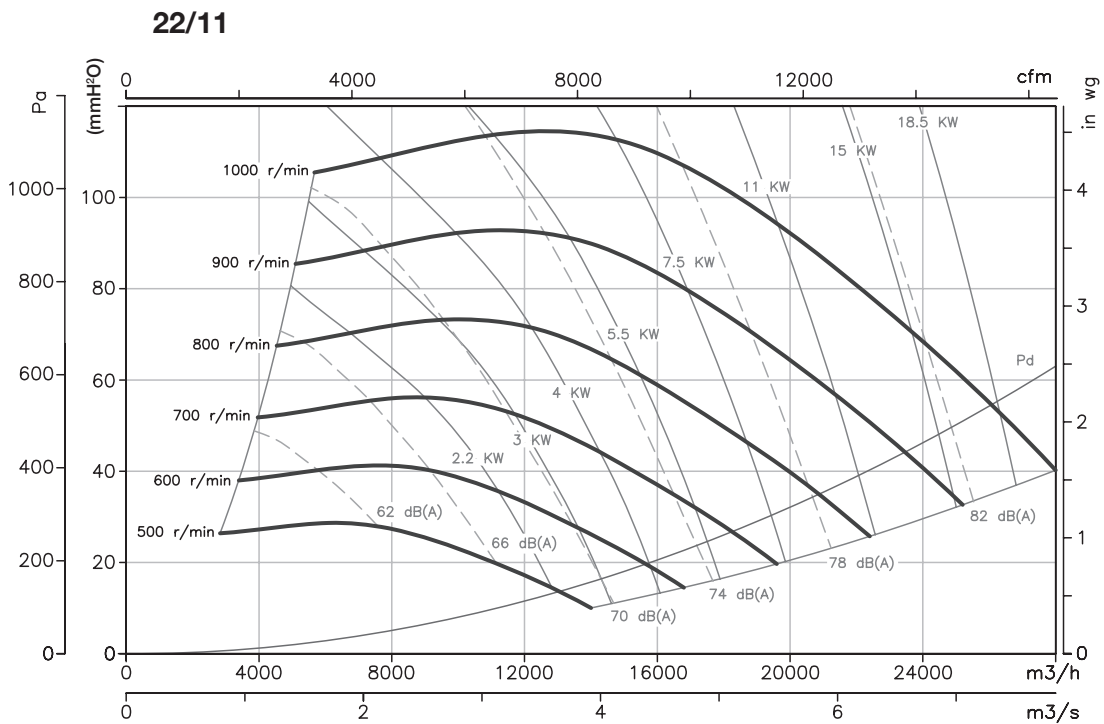
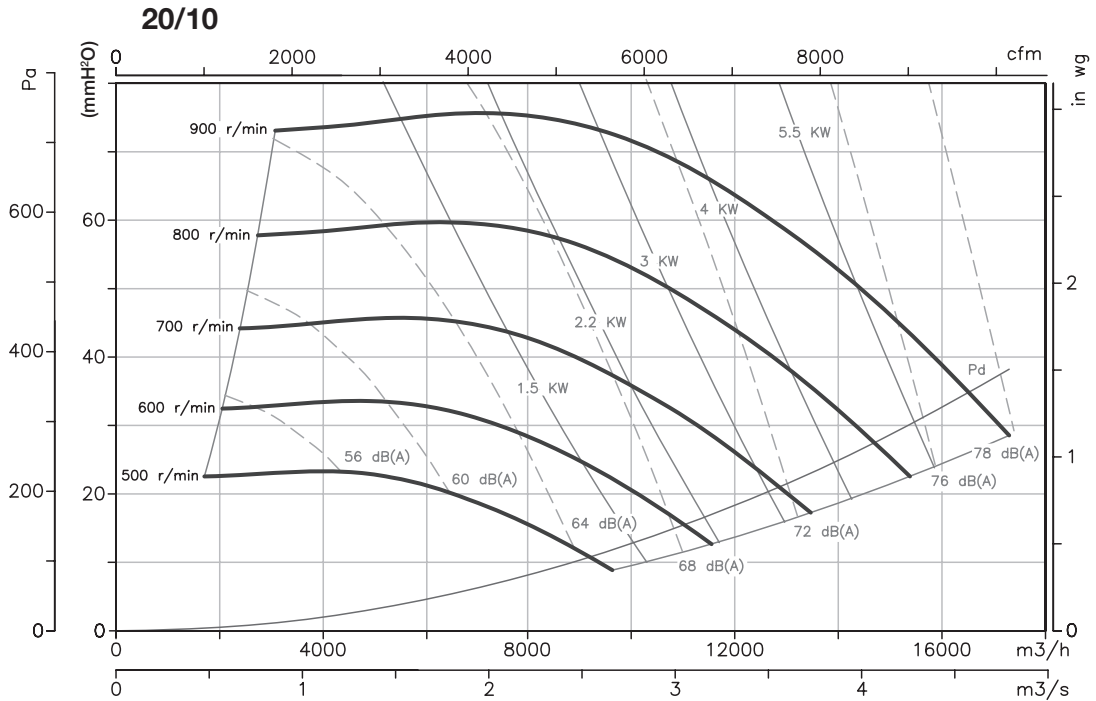

Curvas características

Q= Caudal en m³/h, m³/s y cfm.

Pe= Presión estática en mmH₂O, Pa e inwg.

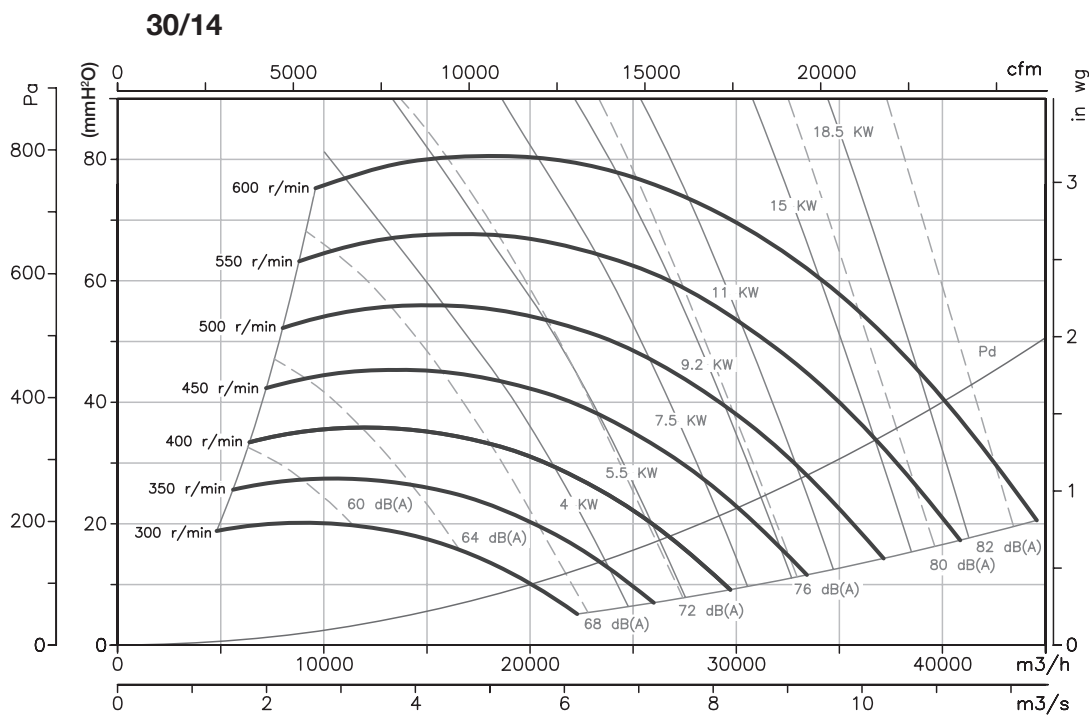
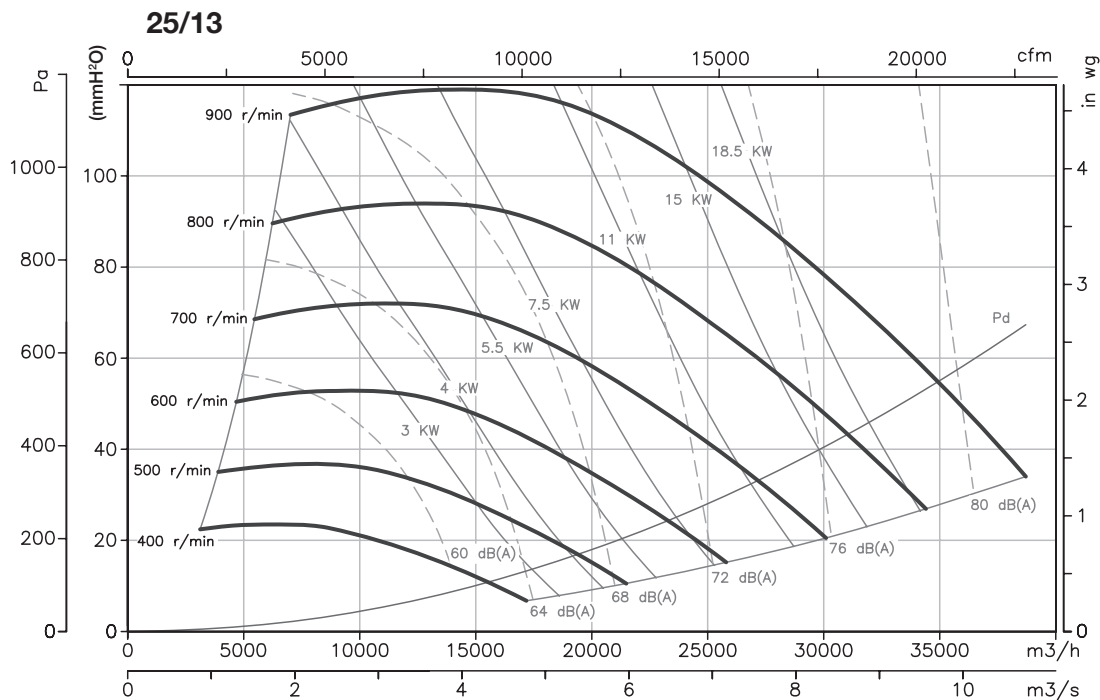

Accesorios



CJBR

Unidades de ventilación aisladas acústicamente con panel tipo sándwich, con sentido lineal del aire entre aspiración e impulsión



Ventilador:

- Estructura en chapa de acero galvanizado, con aislamiento térmico y acústico
- Turbina con álabes a reacción, en chapa de acero galvanizado
- Posibilidad de montar la boca de impulsión en cualquier lateral de la caja, durante la instalación

Motor:

- Motores de eficiencia IE3 para potencias iguales o superiores a 0.75kW. excepto monofásicos. 2 velocidades y 8 polos
- Motores clase F, con rodamientos a bolas, protección IP55.
- Motor Multitensión, diseño especial válido para: 220/380V 60Hz, 254/440V 60Hz,

265/460V 60Hz, 277/480V 60Hz

- Temperatura máxima del aire a transportar: -20°C + 60°C

Acabado:

- Anticorrosivo en chapa de acero galvanizado

Bajo demanda:

- Con impulsión circular, mediante el accesorio TAC
- Con motores de 2 velocidades



Aislamiento acústico de alta eficacia

Código de pedido

CJBR — 2063 — 4T — 60Hz

CJBR: Unidades de ventilación aisladas acústicamente con panel tipo sándwich

Tamaño turbina

Número de polos motor
4=1400 r/min 50 Hz
6=900 r/min 50 Hz

T=Trifásico

Características técnicas

Modelo	Velocidad (r/min)	Intensidad máxima admisible (A)		Potencia instalada (kW)	Caudal máximo m3/h	Nivel presión sonora dB (A)	Peso aprox. (Kg)
		220-277V	380-480V				
CJBR-1240-4T IE3	1704	2,82	1,62	0,75	4250	62	80
CJBR-1850-4T IE3	1728	5,41	3,11	1,50	6700	70	90
CJBR-2056-4T IE3	1722	7,93	4,56	2,20	9500	72	130
CJBR-2056-6T IE3	1128	3,36	1,93	0,75	6500	62	126
CJBR-2263-4T IE3	1758		10,3	5,50	17400	74	202
CJBR-2263-6T IE3	1134	4,68	2,69	1,10	9000	64	141
CJBR-2071-4T IE3	1764		20,9	11,00	25000	83	245
CJBR-2071-6T-3 IE3	1140	9,08	5,22	2,20	12500	68	153
CJBR-2071-6T-5.5 IE3	1152	15,6	8,99	4,00	16000	70	194
CJBR-2880-6T IE3	1152	15,6	8,99	4,00	17100	71	192

Características acústicas

Los valores indicados se determinan mediante medidas de potencia sonora en dB(A) obtenidas en campo libre a una distancia equivalente a dos veces la envergadura del ventilador más el diámetro de la turbina, con un mínimo de 1,5m.

Espectro de potencia sonora Lw(A) en dB(A) por banda de frecuencia en Hz

	63	125	250	500	1000	2000	4000	8000		63	125	250	500	1000	2000	4000	8000
CJBR-1240-4	47	61	67	70	70	71	61	50	CJBR-2263-6	61	67	72	73	77	76	69	62
CJBR-1850-4	66	72	77	78	81	80	73	68	CJBR-2071-4	80	81	89	92	95	96	92	78
CJBR-2056-4	67	73	79	79	83	83	75	68	CJBR-2071-6-3	65	71	76	77	81	80	73	66
CJBR-2056-6	57	63	69	69	73	73	65	58	CJBR-2071-6-5,5	66	65	80	79	83	83	72	61
CJBR-2263-4	74	79	85	87	85	82	75	67	CJBR-2880-6	68	74	79	80	84	83	76	69

Dimensiones mm

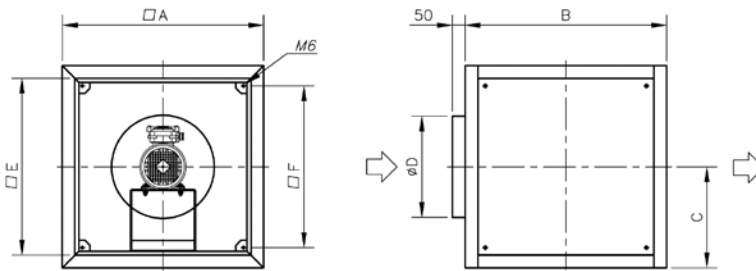

	A	B	C	D	E	F
CJBR-1240	800	800	400	400	700	640
CJBR-1850	800	800	400	400	700	640
CJBR-2056	925	925	462,5	450	825	765
CJBR-2263-4T	1000	1000	500	630	900	840
CJBR-2263-6T	925	925	462,5	560	825	765
CJBR-2071-4T	1060	1060	530	710	960	900
CJBR-2071-6T-3	1000	1000	500	630	900	840
CJBR-2071-6T-5'5	1060	1060	530	710	960	900
CJBR-2880-6T	1060	1060	530	710	960	900

Curvas características

Q= Caudal en m³/h, m³/s y cfm

Pe= Presión estática en mmH₂O, Pa e inwg

Accesorios

Ver apartado accesorios.

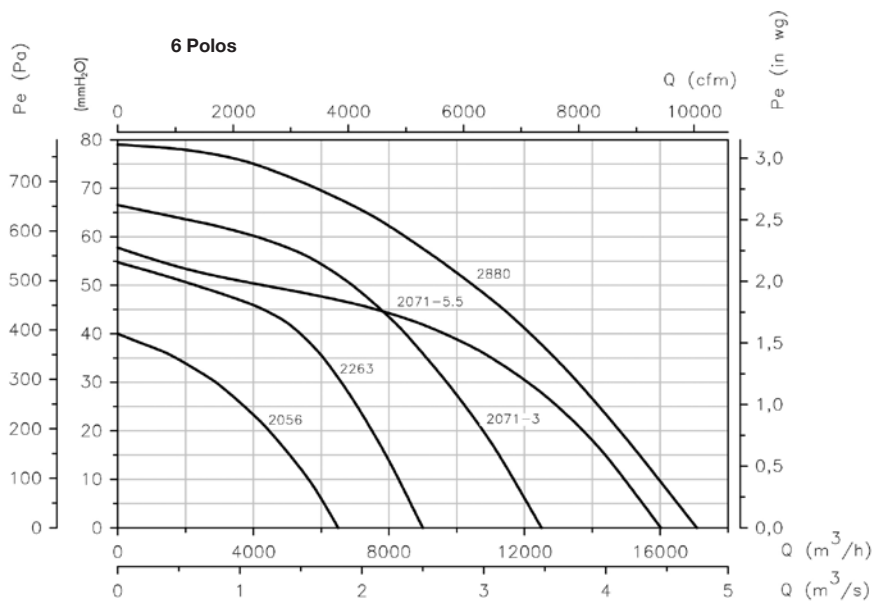
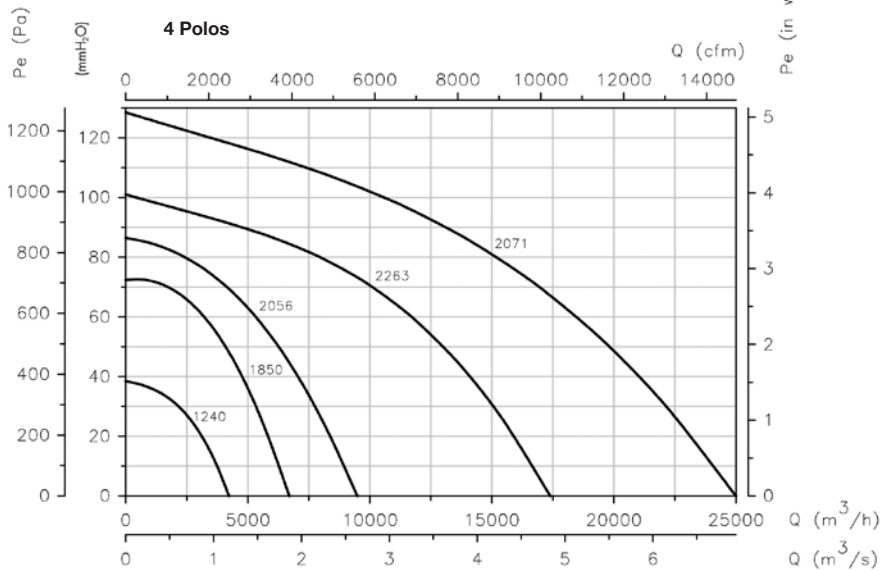

CMP

Ventiladores centrífugos de media presión y simple aspiración con envolvente y turbina en chapa de acero



Ventilador:

- Envolvente en chapa de acero
- Turbina con álabes hacia delante, en chapa de acero galvanizado
- Modelo CMP 38-2M envolvente en fundición de aluminio
- Temperatura máxima del aire a transportar: -20°C.+ 120°C, máximo +100°C modelo CMP-38

Motor:

- Motores de eficiencia IE3 para potencias iguales o superiores a 0,75kW, excepto monofásicos, 2 velocidades y 8 polos.
- Motores clase F, con rodamientos a bolas, protección IP55, excepto modelos monofásicos protección IP54. Modelo CMP-38 protección IP21
- Motor Multitensión, diseño especial válido para: 220/380V 60Hz, 254/440V 60Hz, 265/460V 60Hz, 277/480V 60Hz

Acabado:

- Anticorrosivo en resina de poliéster polimerizada a 190 °C, previo desengrase con tratamiento nanotecnológico libre de fosfatos.

Bajo demanda:

- Bobinados especiales para diferentes tensiones
- Ventilador preparado para transportar aire hasta 250°C
- Ventilador en acero inoxidable
- Certificación ATEX Categoría 2 (ver serie CMP/ATEX)

Rodetes equilibrados dinámicamente con núcleos de gran robustez

Código de pedido

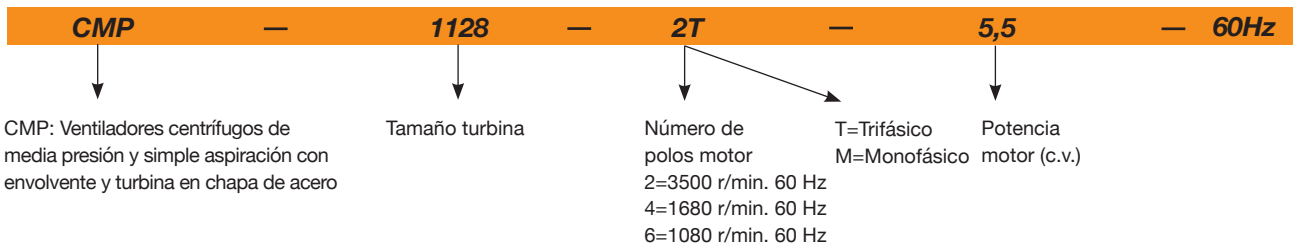

Características técnicas

60Hz

Modelo	Velocidad (r/min)	Intensidad máx admisible (A)		Potencia instalada (kW)	Caudal máximo (m³/h)	Nivel presión sonora dB(A)	Peso aprox. (Kg)
		220-277V	380-480V				
CMP-38-2M/E	3180	0,54		0,01	135	50	2
CMP-38-2M	3120	0,54		0,01	160	50	2
CMP-512-2T	3420	0,55	0,32	0,08	490	62	4
CMP-512-2M	3480	0,6		0,08	490	62	4
CMP-512-4T	1728	0,55	0,32	0,05	255	55	3,5
CMP-512-4M	1728	0,6		0,05	255	55	3,5
CMP-514-2T	3420	1,21	0,7	0,18	800	65	5
CMP-514-2M	3240	1,8		0,18	800	65	5
CMP-514-4T	1728	0,55	0,32	0,08	565	58	4,5
CMP-514-4M	1728	0,6		0,08	565	58	4,5
CMP-616-2T	3288	1,73	1	0,55	1380	69	8
CMP-616-2M	3312	2,95		0,55	1380	69	9,5
CMP-616-4T	1680	0,65	0,37	0,1	850	61	7,5
CMP-616-4M	1680	0,72		0,1	850	61	7,5
CMP-620-2T	3288	1,73	1	0,37	765	68	9,5
CMP-620-2M	3312	2,95		0,37	765	68	10
CMP-620-4T	1650	0,69	0,4	0,1	810	61	7,5
CMP-620-4M	1650	0,76		0,1	810	61	7,5
CMP-718-2T	3426	3	1,73	0,75	1485	70	12,5
CMP-718-2M	3300	5,2		0,75	1485	70	12,8

Características técnicas

Modelo	Velocidad (r/min)	Intensidad máx admisible (A)		Potencia instalada (kW)	Caudal máximo (m³/h)	Nivel presión sonora dB(A)	Peso aprox. (Kg)
		220-277V	380-480V				
CMP-718-4T	1692	1,32	0,76	0,25	1280	63	9,5
CMP-718-4M	1692	1,4		0,25	1280	63	9,5
CMP-820-2T	3414	4,16	2,4	1,1	1950	73	15
CMP-820-2M	3420	7,1		1,1	1950	73	16
CMP-820-4T	1620	1,32	0,76	0,25	1670	66	10
CMP-820-4M	1680	2		0,25	1670	66	10
CMP-922-2T-1,5	3414	4,16	2,4	1,1	1650	70	20
CMP-922-2T-2	3432	5,63	3,25	1,5	2010	71	23
CMP-922-2T-3	3456	7,97	4,6	2,2	2600	74	25,5
CMP-922-4T	1674	2,51	1,45	0,55	2450	66	19
CMP-1025-2T-3	3456	7,97	4,6	2,2	2100	73	28,5
CMP-1025-2T-4	3474	10,57	6,1	3	2830	77	37,6
CMP-1025-4T	1692	4,59	2,65	1,1	3400	70	38,5
CMP-1128-2T-4	3474	10,57	6,1	3	2220	77	41,5
CMP-1128-2T-5,5	3480	13,34	7,7	4	3210	81	47
CMP-1128-4T	1704	8,49	4,9	2,2	5000	74	39
CMP-1128-6T	1092	3,91	2,26	0,75	3300	60	28,5
CMP-1231-4T-3	1704	8,49	4,9	2,2	4740	73	47
CMP-1231-4T-4	1704	11,09	6,4	3	5910	75	49
CMP-1231-4T-5,5	1728	14,38	8,3	4	6850	77	56
CMP-1231-6T	1128	7,48	4,3	1,5	5115	64	49
CMP-1435-4T-4	1704	11,09	6,4	3	5560	76	53
CMP-1435-4T-5,5	1728	14,38	8,3	4	6260	78	61,5
CMP-1435-4T-7,5	1746		11,4	5,5	7210	80	75,5
CMP-1435-6T	1116	9,32	5,36	2,2	6400	66	58,5
CMP-1640-4T-5,5	1728	14,38	8,3	4	7500	77	78,5
CMP-1640-4T-7,5	1746		11,4	5,5	8035	80	92,5
CMP-1640-4T-10	1746		15,1	7,5	9710	82	103,5
CMP-1640-6T	1116	9,32	5,36	2,2	8100	71	75,5
CMP-1845-4T-7,5	1746		11,4	5,5	8965	82	93,5
CMP-1845-4T-10	1746		15,1	7,5	10350	85	104,5
CMP-1845-6T	1116	9,32	5,36	2,2	8330	77	84
CMP-2050-4T-10	1746		15,1	7,5	9000	83	134
CMP-2050-4T-12,5	1740		17,8	9,2	10730	85	137
CMP-2050-4T-15	1752		21,5	11	12525	87	153
CMP-2050-4T-20	1746		28,5	15	19000	89	172
CMP-2050-6T	1128	15,6	8,95	4	11000	79	146
CMP-2563-6T	1164		31	15	21000	86	251

Características acústicas

Espectro de potencia sonora Lw(A) en dB(A) por banda de frecuencia en Hz

Modelo	63	125	250	500	1000	2000	4000	8000	Modelo	63	125	250	500	1000	2000	4000	8000
38	25	35	46	53	57	54	52	45	1128-6	35	45	56	63	67	64	62	55
512-2	37	47	58	65	69	66	64	57	1231-4-3	51	60	71	78	82	80	78	71
512-4	30	40	51	58	62	59	57	50	1231-4-4	53	62	73	80	84	82	80	73
514-2	40	50	61	68	72	69	67	60	1231-4-5,5	55	64	75	82	86	84	82	75
514-4	33	43	54	61	65	62	60	53	1231-6	42	51	62	69	73	71	69	62
616-2	44	54	65	72	76	73	71	64	1435-4-4	54	63	74	81	85	83	81	74
616-4	36	46	57	64	68	65	63	56	1435-4-5,5	56	65	76	83	87	85	83	76
620-2	43	53	64	71	75	72	70	63	1435-4-7,5	58	67	78	85	89	87	85	78
620-4	36	46	57	64	68	65	63	56	1435-6	44	53	64	71	75	73	71	64
718-2	45	55	66	73	77	74	72	65	1640-4-5,5	55	64	75	82	86	84	82	75
718-4	38	48	59	66	70	67	65	58	1640-4-7,5	58	67	78	85	89	87	85	78
820-2	48	58	69	76	80	77	75	68	1640-4-10	60	69	80	87	91	89	87	80
820-4	41	51	62	69	73	70	68	61	1640-6	49	58	69	76	80	78	76	69
922-2-1,5	45	55	66	73	77	74	72	65	1845-4-7,5	61	71	82	89	93	91	89	81
922-2-2	46	56	67	74	78	75	73	66	1845-4-10	64	74	85	92	96	94	92	84
922-2-3	49	59	70	77	81	78	76	69	1845-6	56	66	77	84	88	86	84	76
922-4	41	51	62	69	73	70	68	61	2050-4-10	62	72	83	90	94	92	90	82
1025-2-3	48	58	69	76	80	77	75	68	2050-4-12,5	64	74	85	92	96	94	92	84
1025-2-4	52	62	73	80	84	81	79	72	2050-4-15	66	76	87	94	98	96	94	86
1025-4	45	55	66	73	77	74	72	65	2050-4-20	68	78	89	96	100	98	96	88
1128-2-4	52	62	73	80	84	81	79	72	2050-6	58	68	79	86	90	88	86	78
1128-2-5,5	56	66	77	84	88	85	83	76	2563-6	67	77	88	95	99	96	94	87
1128-4	49	59	70	77	81	78	76	69									

Dimensiones mm

CMP-38

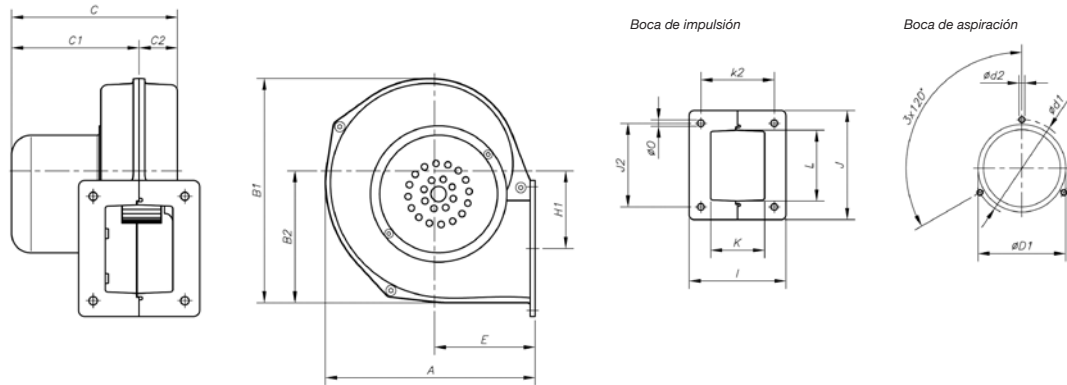

Modelo	A	B1	B2	C	C1	C2	øD1*	ød1	ød2	E	H1	I	J	J2	K	k2	L	ø0
CMP-38-2M/E	141	165	97	122	96	26	80	85	2,4	60	60,5	100	80	46	50	77	52	8
CMP-38-2M	164,5	176,5	103,5	130	99	31	80	85	M4	79	64	95	107	82	53	72	67	6,5

* Diámetro nominal tubería recomendada

CMP-512...820

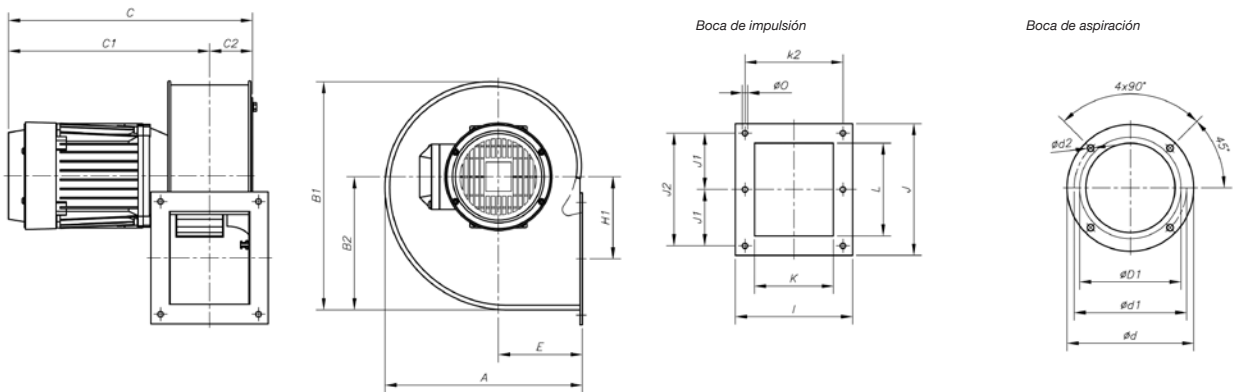

Modelo	A	B1	B2	C	C1	C2	øD1*	ød	ød1	ød2	E	H1	I	J	J1	J2	K	k2	L	ø0
CMP-512-2T	185	206,5	118	251	212	39	112	140	132	M4	82,5	69	104	117	-	104,5	75	92	86	5,5
CMP-512-4T	185	206,5	118	249	210	39	112	140	132	M4	82,5	69	104	117	-	104,5	75	92	86	5,5
CMP-514-2T	225	254	150	281	236	45	140	169	151,5	M4	100	91	122	147	64	128	838	105	107	6,5
CMP-514-4T	225	254	150	261	216	45	140	169	151,5	M4	100	91	122	147	64	128	83	105	107	6,5
CMP-616-2T	258	297	173,5	320	264	56	160	204	180	M6	110	105,5	153	172	-	147	103	128	125	7
CMP-616-4T	258	297	173,5	283	227	56	160	204	180	M6	110	105,5	153	172	-	147	103	128	125	7
CMP-620-2T	298	347	202,5	321	265	56	200	247	230	M6	126	145,5	159	153	-	128	105	134	100	8
CMP-620-4T	298	347	202,5	283	227	56	200	247	230	M6	126	145,5	159	153	-	128	105	134	100	8
CMP-718-2T	303,5	348	201	355	294	61	180	238	210	M6	129,5	122	169	192	85	170	115	145	146	9
CMP-718-2M	303,5	348	201	355	245	61	180	238	210	M6	129,5	122	169	192	85	170	115	145	146	9
CMP-718-4T	303,5	348	201	331	270	61	180	238	210	M6	129,5	122	169	192	85	170	115	145	146	9
CMP-718-4M	303,5	348	201	331	270	61	180	238	210	M6	129,5	122	169	192	85	170	115	145	146	9
CMP-820-2T	322	377	223	369,5	301	68,5	200	247	230	M6	137,5	137	184	213	94,5	189	160	160	156	9
CMP-820-2M	322	377	223	369,5	301	68,5	200	247	230	M6	137,5	137	184	213	94,5	189	160	160	156	9
CMP-820-4T	322	377	223	345,5	277	68,5	200	247	230	M6	137,5	137	184	213	94,5	189	160	160	156	9
CMP-820-4M	322	377	223	345,5	277	68,5	200	247	230	M6	137,5	137	184	213	94,5	189	160	160	156	9

* Diámetro nominal tubería recomendada

Dimensiones mm

CMP-922...1231

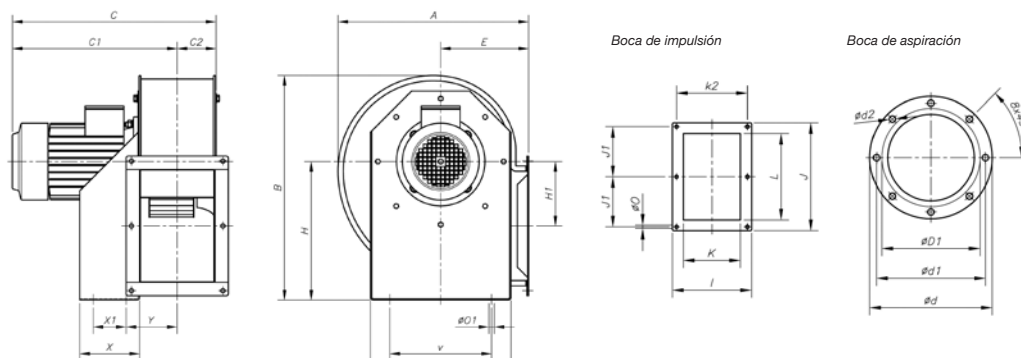

Modelo	A	B	C	C1	C2	øD1*	ød	ød1	ød2	E	H	H1	I	J	J1	K	k2	L	ø0	øD1	V	v	X	X1	Y
CMP-922-2T-1'5	388,5	455	382,5	309	73,5	224	278	256	M8	180	280	134	204	282,5	128	140	180	215	9,5	10,5	290	220	114	50	105
CMP-922-2T-2	388,5	455	430,5	357	73,5	224	278	25	M8	180	280	134	204	282,5	128	140	180	215	9,5	10,5	290	220	114	50	105
CMP-922-2T-3	388,5	455	430,5	357	73,5	224	278	256	M8	180	280	134	204	282,5	128	140	180	215	9,5	10,5	290	220	114	50	105
CMP-922-4T	388,5	455	382,5	309	73,5	224	278	256	M8	180	280	134	204	282,5	128	140	180	215	9,5	10,5	290	220	114	50	105
CMP-1025-2T-3	427	503	456	370	86	250	305	282	M8	197	310	144	229	312,5	145	165	205	250	9,5	12,5	315	228	134	74	115,5
CMP-1025-2T-4	427	503	486	400	86	250	305	282	M8	197	310	144	229	312,5	145	165	205	250	9,5	12,5	315	228	134	74	115,5
CMP-1025-4T	427	503	456	370	86	250	305	282	M8	197	310	144	229	312,5	145	165	205	250	9,5	12,5	315	228	134	74	115,5
CMP-1128-2T-4	472	553	500,5	407	93,5	280	348	320	M8	216	340	152	244	364	170	180	220	296,5	9,5	12,5	348	245	144	95	122,5
CMP-1128-2T-5'5	472	553	523,5	430	93,5	280	348	320	M8	216	340	152	244	364	170	180	220	296,5	9,5	12,5	348	245	144	95	122,5
CMP-1128-4T	472	553	500,5	407	93,5	280	348	320	M8	216	340	152	244	364	170	180	220	296,5	9,5	12,5	348	245	144	95	122,5
CMP-1128-6T	472	553	470,5	377	93,5	280	348	320	M8	216	340	152	244	364	170	180	220	296,5	9,5	12,5	348	245	144	95	122,5
CMP-1231-4T-3	526	630	520,5	417	103,5	315	382	354	M8	238	390	179,5	264	382,5	180	200	240	320	11,5	13	382	322	183	140	126
CMP-1231-4T-4	526	630	520,5	417	103,5	315	382	354	M8	238	390	179,5	264	382,5	180	200	240	320	11,5	13	382	322	183	140	126
CMP-1231-4T-5'5	526	630	543,5	440	103,5	315	382	354	M8	238	390	179,5	264	382,5	180	200	240	320	11,5	13	382	322	183	140	126
CMP-1231-6T	526	630	520,5	417	103,5	315	382	354	M8	238	390	179,5	264	382,5	180	200	240	320	11,5	13	382	322	183	140	126

* Diámetro nominal tubería recomendada

CMP-1435...2563

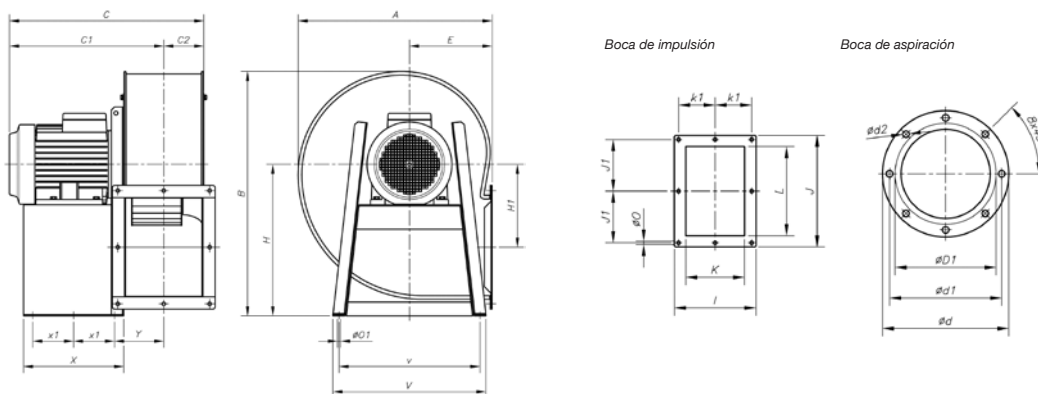

Modelo	A	B	C	C1	C2	øD1*	ød	ød1	ød2	E	H	H1	I	J	J1	K	k1	L	ø0	øD1	V	v	X	X1	Y
CMP-1435-4T-4	573,5	715	549	431	118	355	422	394	M8	250	445	242,5	292	342,5	159	228	133	280	11,5	12	456	420	333	136,5	150
CMP-1435-4T-5'5	573,5	715	572	454	118	355	422	394	M8	250	445	242,5	292	342,5	159	228	133	280	11,5	12	456	420	333	136,5	150
CMP-1435-4T-7'5	573,5	715	610	492	118	355	422	394	M8	250	445	242,5	292	342,5	159	228	133	280	11,5	12	456	420	333	136,5	150
CMP-1435-6T	573,5	715	572	454	118	355	422	394	M8	250	445	242,5	292	342,5	159	228	133	280	11,5	12	456	420	333	136,5	150
CMP-1640-4T-5'5	634	799	596	465	130	400	464	438	M8	270	495	271	336	404	185	250	150	321	11,5	12	500	460	327	133,5	162,5
CMP-1640-4T-7'5	634	799	634	504	130	400	464	438	M8	270	495	271	336	404	185	250	150	321	11,5	12	500	460	327	133,5	162,5
CMP-1640-4T-10	634	799	634	504	130	400	464	438	M8	270	495	271	336	404	185	250	150	321	11,5	12	500	460	327	133,5	162,5
CMP-1640-6T	634	799	596	466	130	400	464	438	M8	270	495	271	336	404	185	250	150	321	11,5	12	500	460	327	133,5	162,5
CMP-1845-4T-7'5	711	901	668	521	147	450	515	485	M8	302	560	305	370	444	202	284	164	361	11,5	12	538	502	340	140	179,5
CMP-1845-4T-10	711	901	668	521	147	450	515	485	M8	302	560	305	370	444	202	284	164	361	11,5	12	538	502	340	140	179,5
CMP-1845-6T	711	901	630	483	147	450	515	485	M8	302	560	305	370	444	202	284	164	361	11,5	12	538	502	340	140	179,5
CMP-2050-4T-10	797	987	700,5	538	162,5	500	565	535	M10	345	610	313	411	544	250	315	182,5	451	11,5	12	653	615	435	188	196
CMP-2050-4T-12'5	797	987	752,5	590	162,5	500	565	535	M10	345	610	313	411	544	250	315	182,5	451	11,5	12	653	615	435	188	196
CMP-2050-4T-15	797	987	805,5	643	162,5	500	565	535	M10	345	610	313	411	544	250	315	182,5	451	11,5	12	653	615	435	188	196
CMP-2050-4T-20	797	987	805,5	643	162,5	500	565	535	M10	345	610	313	411	544	250	315	182,5	451	11,5	12	653	615	435	188	196
CMP-2050-6T	797	987	700,5	538	162,5	500	565	535	M10	345	610	313	411	544	250	315	182,5	451	11,5	12	653	615	435	188	196
CMP-2563-6T	1027	1213	1016	805	211	630	710	675	M10	460	742	378	512	706	330	410	230	600	17	14	590	540	450	200	239

* Diámetro nominal tubería recomendada

Curvas características

Q= Caudal en m³/h, m³/s y cfm.

Pe= Presión estática en mmH₂O, Pa e inwg.

CMP-38...820

2T/2M=3600 r/min

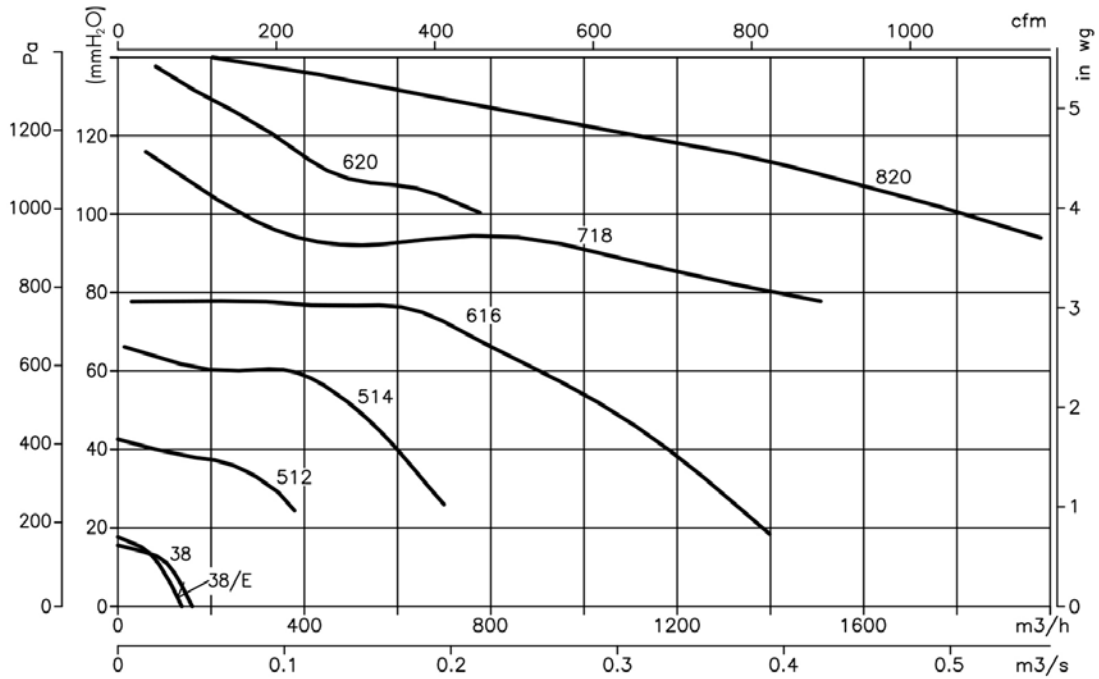

4T/4M=1800 r/min

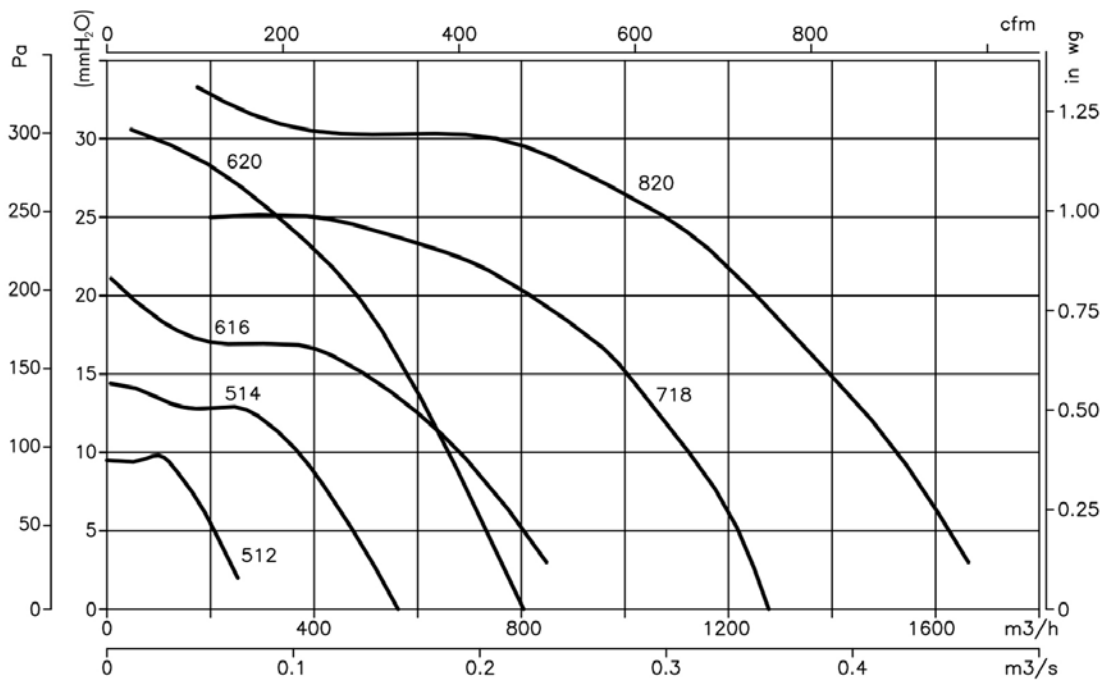

Curvas características

Q= Caudal en m³/h, m³/s y cfm.

Pe= Presión estática en mmH₂O, Pa e inwg.

CMP-922...1231

2T=3600 r/min

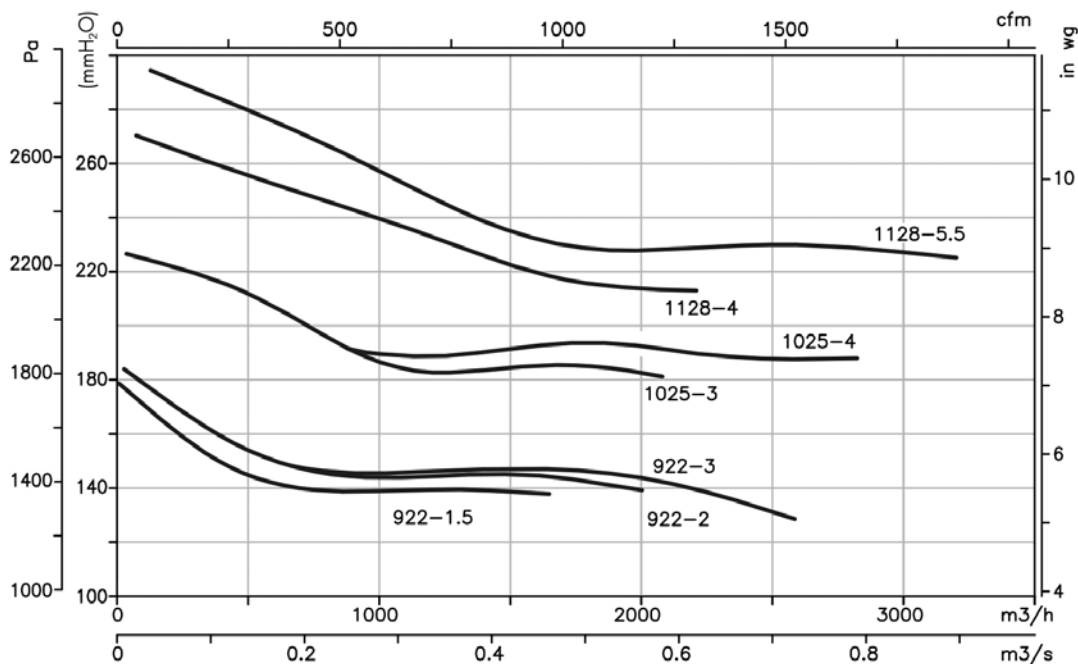

4T=1500 r/min 6T=1200 r/min

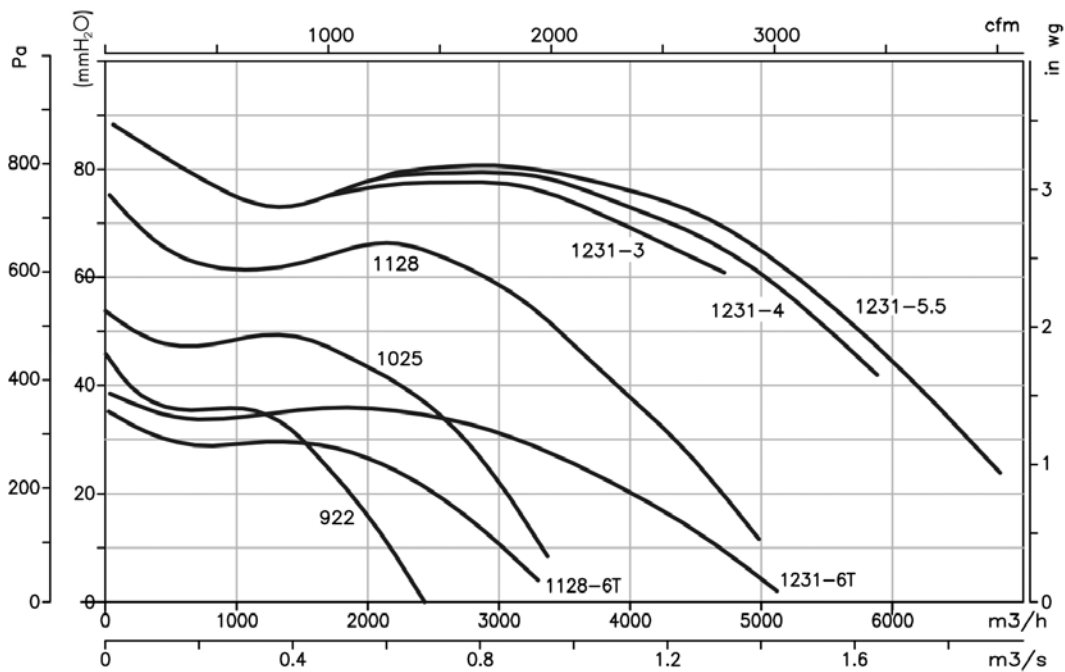

Curvas características

Q= Caudal en m³/h, m³/s y cfm.

Pe= Presión estática en mmH₂O, Pa e inwg.

CMP-1435...2563

4T=1800 r/min

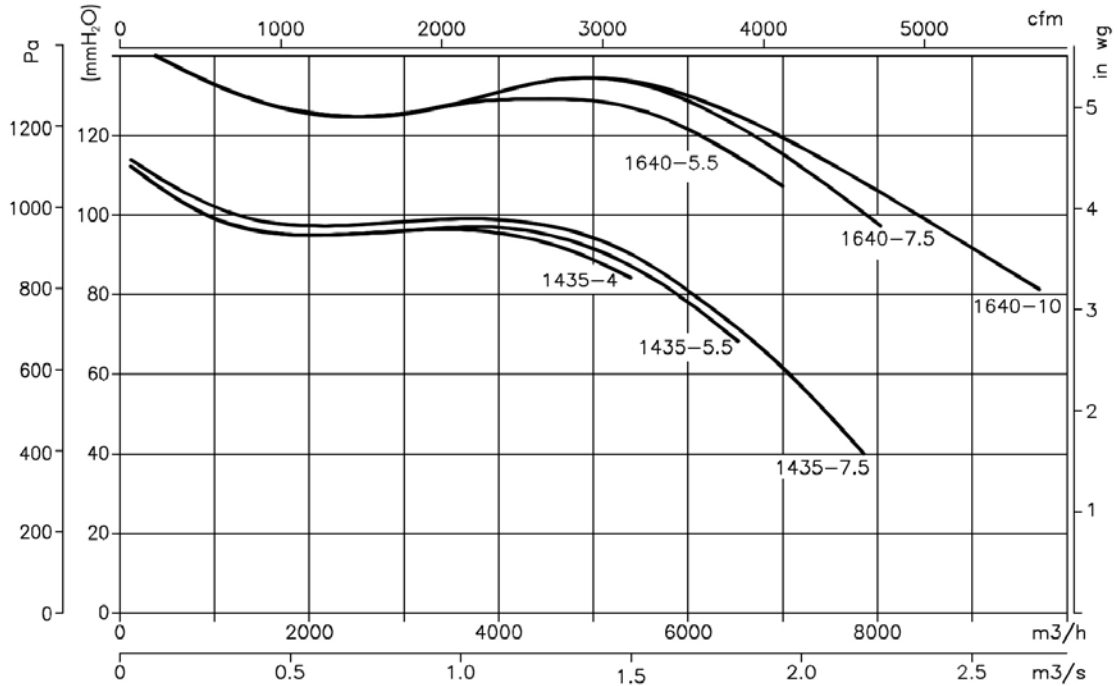

4T=1800 r/min

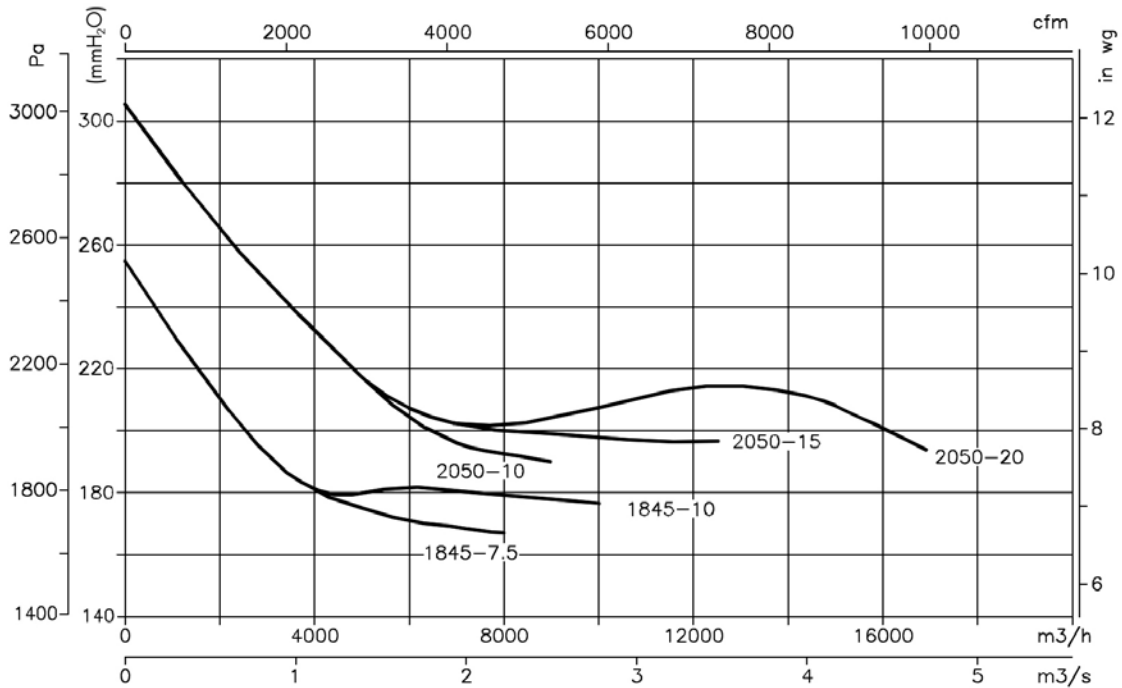

Curvas características

Q= Caudal en m³/h, m³/s y cfm.

Pe= Presión estática en mmH₂O, Pa e inwg.

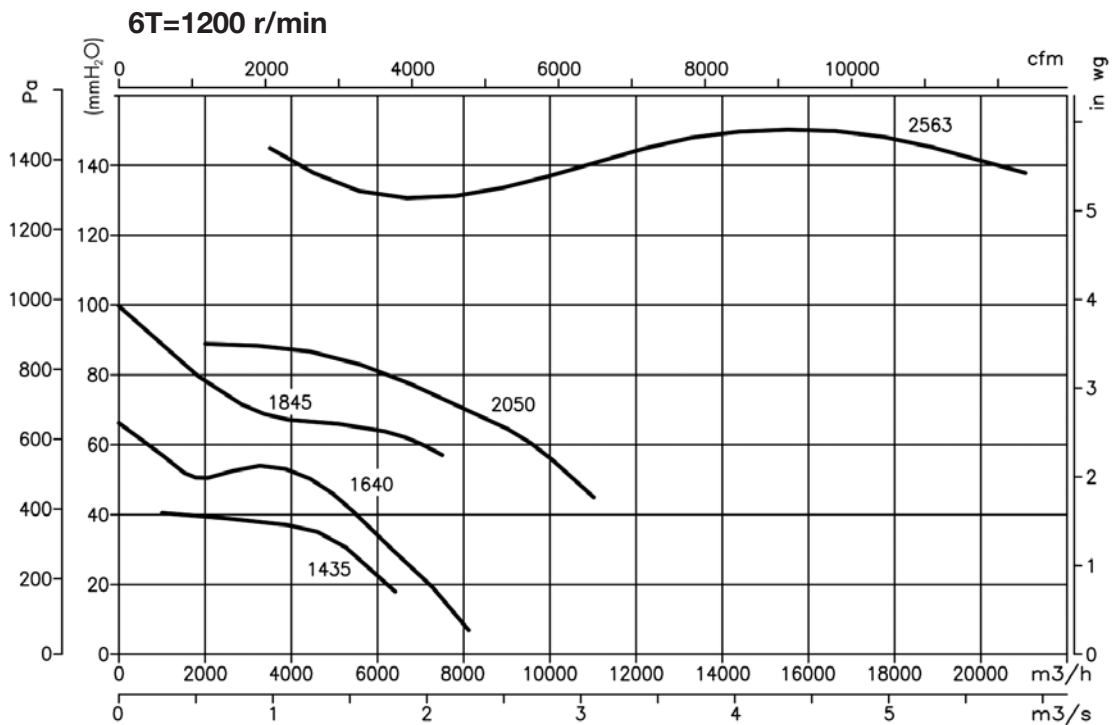

Orientaciones

Suministro standard LG 270

Posiciones LG 180 y RD 180 bajo demanda y con medidas de anclaje especiales.

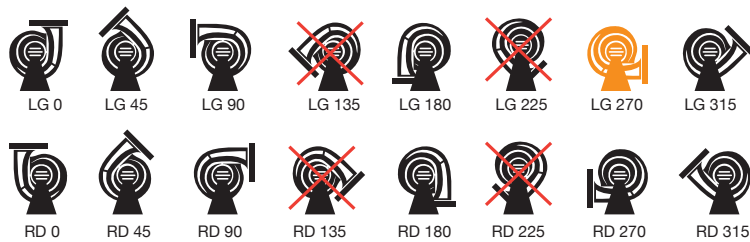

Accesorios

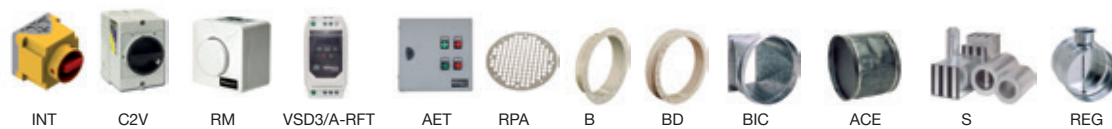

CMR

Ventiladores centrífugos de media presión y simple aspiración, de gran robustez, equipados con turbina con álabes hacia atrás



Turbina a reacción de alto rendimiento, y gran robustez

Ventilador:

- Envoltente en chapa de acero
- Turbina con álabes a reacción, en chapa de acero de gran robustez

Motor:

- Motores de eficiencia IE3 para potencias iguales o superiores a 0,75kW, excepto monofásicos, 2 velocidades y 8 polos.
- Motores clase F, con rodamientos a bolas, protección IP55
- Motor Multitensión, diseño especial válido para: 220/380V 60Hz, 254/440V 60Hz, 265/460V 60Hz, 277/480V 60Hz
- Temperatura máxima del aire a transportar: -20°C.+ 120°C.

Acabado:

- Anticorrosivo en resina de poliéster polimerizada a 190 °C, previo desengrase con tratamiento nanotecnológico libre de fosfatos.

Bajo demanda:

- Bobinados especiales para diferentes tensiones.
- Ventilador preparado para transportar aire hasta 250°C.
- Ventilador en acero inoxidable
- Certificación ATEX Categoría 2 (ver serie CMR/ATEX)

Código de pedido

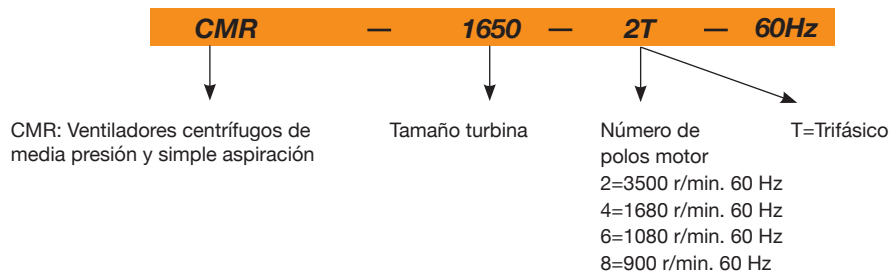

Características técnicas

60Hz

Modelo	Velocidad (r/min)	Intensidad máx admisible (A)		Potencia instalada (kW)	Caudal máximo (m³/h)	Nivel presión sonora dB(A)	Peso aprox. (Kg)
		220-277V	380-480V				
CMR-1031-2T-3	3480	7,88	4,55	2,20	5950	80	44,3
CMR-1135-2T-5,5	3480	13,51	7,80	4,00	7700	83	54,9
CMR-1240-2T	3475	13,51	7,80	4,00	7650	86	93,5
CMR-1240-4T	1745	3,22	1,86	0,75	5850	71	70,5
CMR-1445-2T	3500		13,90	7,50	10800	87	126,0
CMR-1445-4T	1750	5,89	3,40	1,50	8950	72	92,5
CMR-1650-2T-15	3490		20,00	11,00	15950	89	178,0
CMR-1650-4T-3	1730	8,49	4,90	2,20	11700	74	114,0
CMR-1650-6T	1165	5,04	2,90	1,10	7850	64	114,0
CMR-1856-4T-5,5	1745	14,38	8,30	4,00	15350	79	152,0
CMR-1856-6T	1160	7,48	4,30	1,50	11100	70	146,5
CMR-2063-4T	1750		11,40	5,50	19000	80	226,0
CMR-2063-6T	1120	7,48	4,30	1,50	12300	71	208,5
CMR-2063-8T	870	5,90	3,39	1,10	10550	65	210,5
CMR-2271-4T	1760		21,50	11,00	30200	85	315,0
CMR-2271-6T	1140	12,20	6,82	3,00	19600	76	293,5
CMR-2271-8T	865	7,10	4,08	1,50	14300	69	275,5
CMR-2380-4T	1680		41,00	22,00	48000	83	416,0
CMR-2380-6T	1080		15,40	7,50	30000	75	363,0
CMR-2380-8T	840	12,80	7,38	3,00	22000	66	317,0
CMR-2590-4T	1770		68,00	37,00	54000	86	418,0
CMR-2590-6T	1165		23,00	11,00	34000	76	378,0
CMR-28100-4T	1770		98,00	55,00	75000	87	553,0
CMR-28100-6T	1180		36,00	18,50	48000	77	521,0

Características acústicas

Los valores indicados, se determinan mediante medidas de nivel de presión y potencia sonora en dB(A) obtenidas en campo libre a una distancia equivalente a dos veces la envergadura del ventilador más el diámetro de la turbina, con un mínimo de 1,5 mts.

Espectro de potencia sonora Lw(A) en dB(A) por banda de frecuencia en Hz

Modelo	63	125	250	500	1000	2000	4000	8000	Modelo	63	125	250	500	1000	2000	4000	8000
1031-2	65	78	78	91	86	86	86	79	2063-6	69	70	82	82	81	83	73	63
1135-2	72	79	77	89	87	93	92	79	2063-8	64	70	77	76	77	74	66	57
1240-2	68	83	81	93	90	94	96	83	2271-4	83	84	93	96	98	99	95	82
1240-4	56	70	76	79	79	80	70	59	2271-6	73	73	87	86	90	90	79	68
1445-2	73	85	83	95	93	97	99	89	2271-8	68	73	78	85	81	80	70	59
1445-4	59	72	78	83	80	83	78	64	2380-4	76	78	94	91	96	97	93	82
1650-2	73	81	85	99	97	99	99	88	2380-6	68	70	86	83	88	89	85	74
1650-4	64	74	82	84	83	85	76	66	2380-8	59	61	77	74	79	80	76	65
1650-6	53	65	72	77	73	69	62	54	2590-4	79	84	97	100	96	89	84	66
1856-4	69	78	91	87	90	91	85	71	2590-6	70	79	89	88	85	84	74	68
1856-6	61	69	81	83	80	81	71	60	28100-4	82	89	101	102	97	93	87	78
2063-4	80	85	91	93	91	88	81	73	28100-6	73	82	91	90	88	86	77	70

Dimensiones mm

CMR-1031...2271

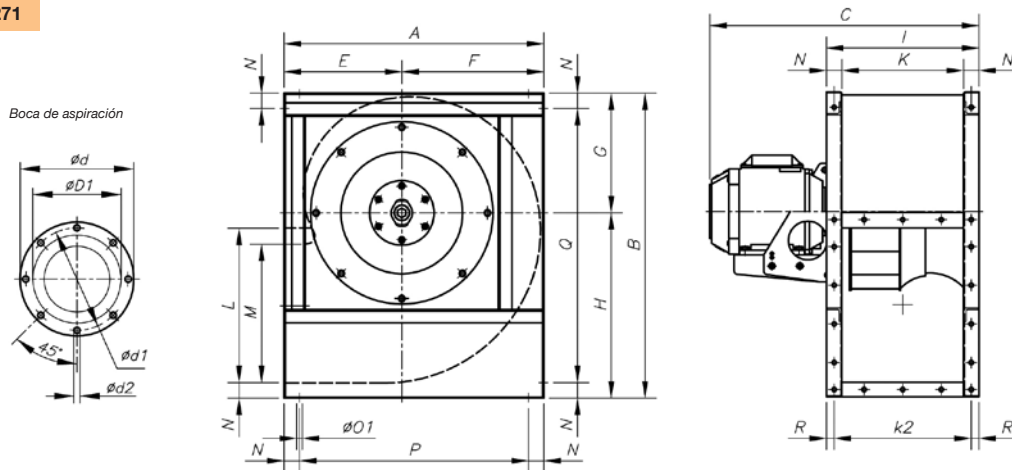

Modelo	A	B	C	$\phi D1^*$	ϕd	$\phi d1$	$\phi d2$	E	F	G	H	I	K	k2	L	M	N	$\phi O1$	P	Q	R
CMR-1031-2T	542	626	567	315	383	356	M8	250	292	245	381	320	250	285	315	276	35	11	472	556	17,5
CMR-1135-2T	600	696	583	355	425	398	M8	275	325	273	423	350	280	315	355	310	35	11	530	626	17,5
CMR-1240-2T	673	790	728	400	472	444	M10	305	368	310	480	395	315	355	400	358	40	11	593	710	20
CMR-1240-4T	673	790	590	400	472	444	M10	305	368	310	480	395	315	355	400	358	40	11	593	710	20
CMR-1445-2T	765	880	810	450	522	494	M10	350	415	339	541	445	355	405	450	404	45	11	675	790	20
CMR-1445-4T	765	880	649	450	522	494	M10	350	415	339	541	445	355	405	450	404	45	11	675	790	20
CMR-1650-2T	832	970	961	500	582	555	M10	375	457	378	592	490	400	450	500	445	45	13	742	880	20
CMR-1650-4T	832	970	715	500	582	555	M10	375	457	378	592	490	400	450	500	445	45	13	742	880	20
CMR-1650-6T	832	970	695	500	582	555	M10	375	457	378	592	490	400	450	500	445	45	13	742	880	20
CMR-1856-4T	925	1084	832	560	645	615	M10	415	510	426	658	550	450	500	560	493	50	13	825	984	25
CMR-1856-6T	925	1084	771	560	645	615	M10	415	510	426	658	550	450	500	560	493	50	13	825	984	25
CMR-2063-4T	1037	1218	973	630	720	688	M10	465	572	477	741	620	500	560	630	530	60	13	917	1098	30
CMR-2063-6T	1037	1218	893	630	720	688	M10	465	572	477	741	620	500	560	630	530	60	13	917	1098	30
CMR-2063-8T	1037	1218	893	630	720	688	M10	465	572	477	741	620	500	560	630	530	60	13	917	1098	30
CMR-2271-4T	1173	1375	1126	710	800	768	M12	525	648	538	837	690	560	625	710	603	65	13	1043	1245	32,5
CMR-2271-6T	1173	1375	1039	710	800	768	M12	525	648	538	837	690	560	625	710	603	65	13	1043	1245	32,5
CMR-2271-8T	1173	1375	1002	710	800	768	M12	525	648	538	837	690	560	625	710	603	65	13	1043	1245	32,5

* Diámetro nominal tubería recomendada

Dimensiones mm

CMR-2380...28100

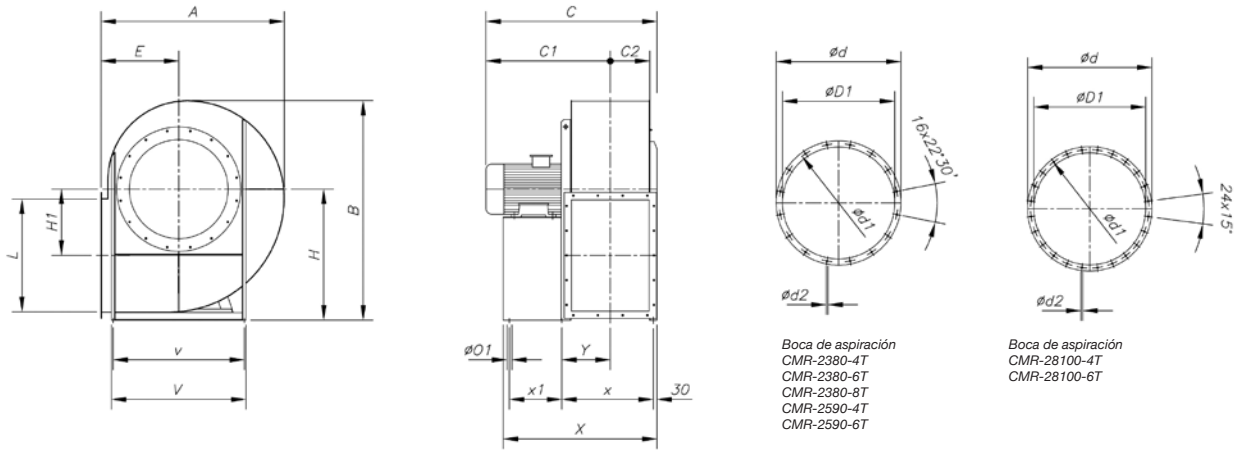

Modelo	A	B	C	C1	C2	øD1*	ød	ød1	ød2	E	H	H1	L	øO1	V	v	X	x	x1	Y
CMR-2380-4T	1350	1660	1245	899	286	808	906	861	11,5	560	1000	500	800	17	930	870	1102,5	667,5	370	352,5
CMR-2380-6T	1350	1660	1030	744	286	808	906	861	11,5	56	1000	500	800	17	930	870	1102,5	667,5	370	352,5
CMR-2380-8T	1350	1660	1035	681	286	808	906	861	11,5	560	1000	500	800	17	930	870	1102,5	667,5	370	352,5
CMR-2590-4T	1495	1785	1390	1012	321	908	1008	958	14	630	1060	535	900	19	1030	970	1246	425	751	393
CMR-2590-6T	1495	1785	1235	857	321	908	1008	958	14	630	1060	535	900	19	1030	970	1121	340	721	373
CMR-28100-4T	1680	1990	1470	1051	362	1008	1108	1067	14	710	1180	610	1000	19	1130	1060	1378	460	843	454
CMR-28100-6T	1680	1990	1395	976	362	1008	1108	1067	14	710	1180	610	1000	19	1130	1060	1278	385	823	434

* Diámetro nominal tubería recomendada

Boca Impulsión

CMR-1031
CMR-1135
CMR-2590
CMR-28100

CMR-1240
CMR-1445
CMR-1650

CMR-1856

CMR-2063

CMR-2271

CMR-2380

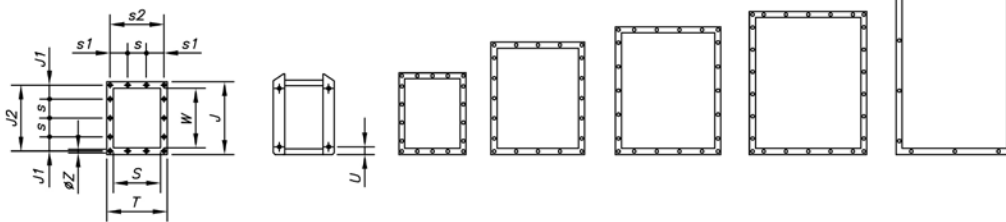

Modelo	T	J	J1	J2	S	s	s1	s2	W	øz	U
CMR-1031	320	385	75	350	250	100	92,5	285	315	9	-
CMR-1135	350	425	95	390	280	100	107,5	315	355	9	-
CMR-1240	395	480	70	440	315	100	77,5	355	400	11	-
CMR-1445	445	540	99	498	355	100	102,5	403	450	11	-
CMR-1650	490	590	88	550	400	125	100	450	500	11	-
CMR-1856	550	660	55	610	450	125	125	500	560	13	-
CMR-2063	620	750	95	690	500	125	92,5	560	630	13	-
CMR-2271	690	840	75	775	560	125	62,5	625	710	13	-
CMR-2380	689	921	135,5	871	569	200	119,5	639	801	14	-
CMR-2590	758	1018	84	968	638	200	54	708	898	18	-
CMR-28100	835	1127	138,5	1077	715	200	92,5	785	1007	18	-

Curvas Características

Q= Caudal en m³/h, m³/s y cfm.

Pe= Presión estática en mmH₂O, Pa e inwg.

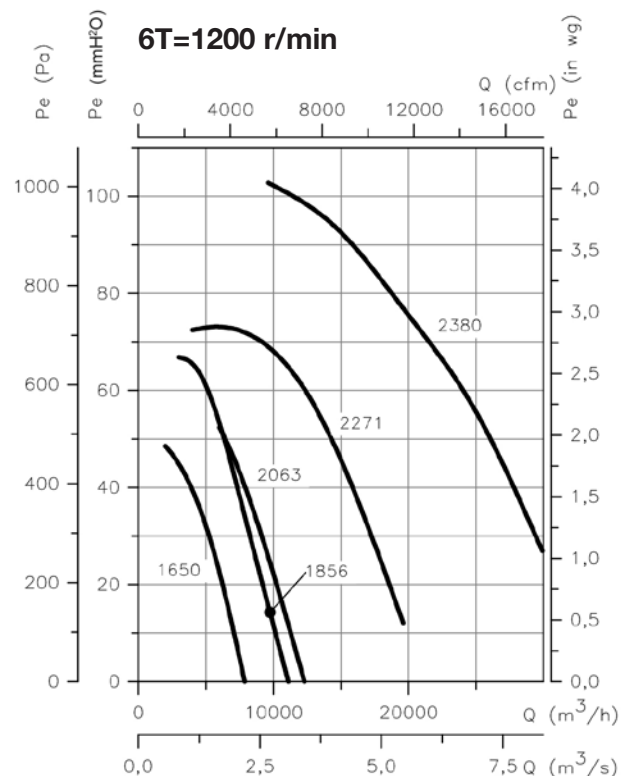
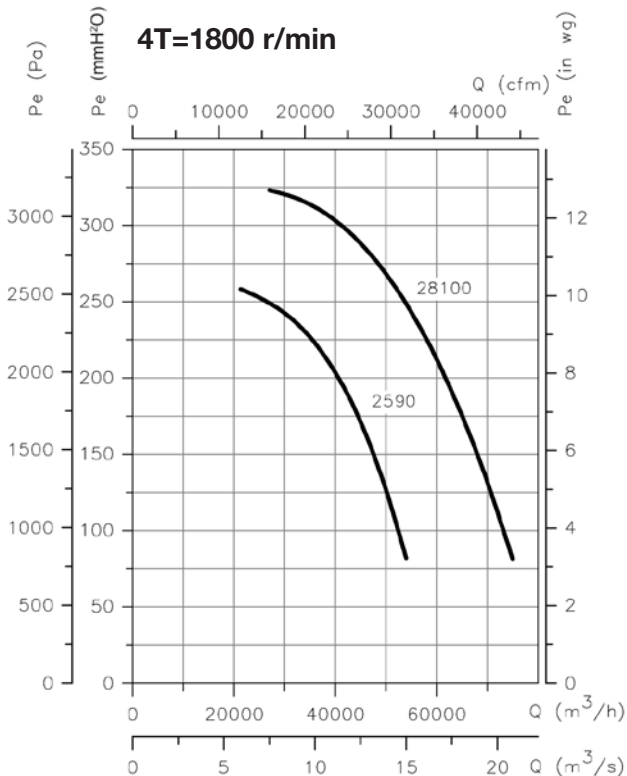
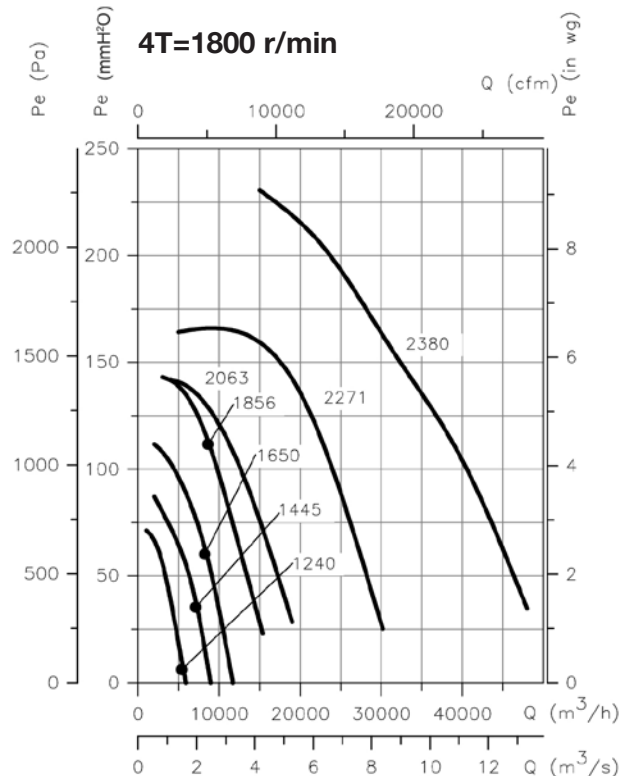
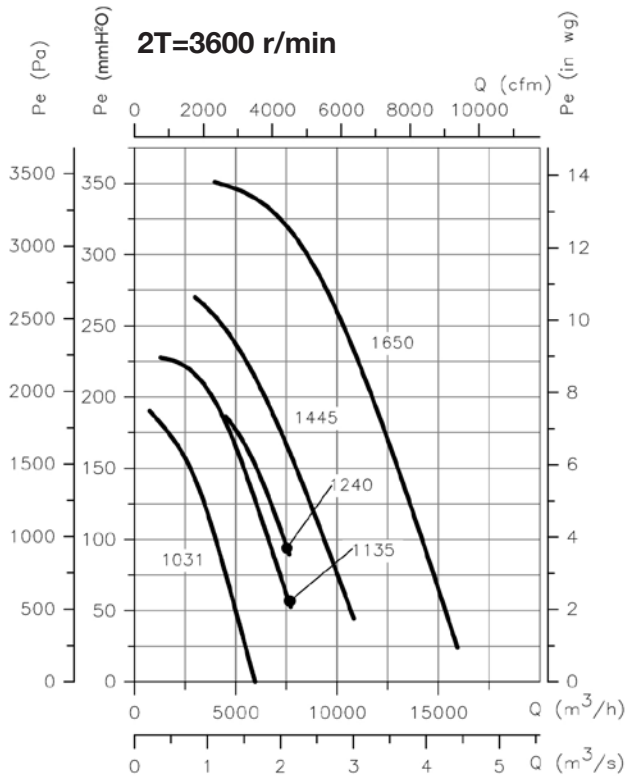

Curvas Características

Q= Caudal en m³/h, m³/s y cfm.

Pe= Presión estática en mmH²O, Pa e inwg.

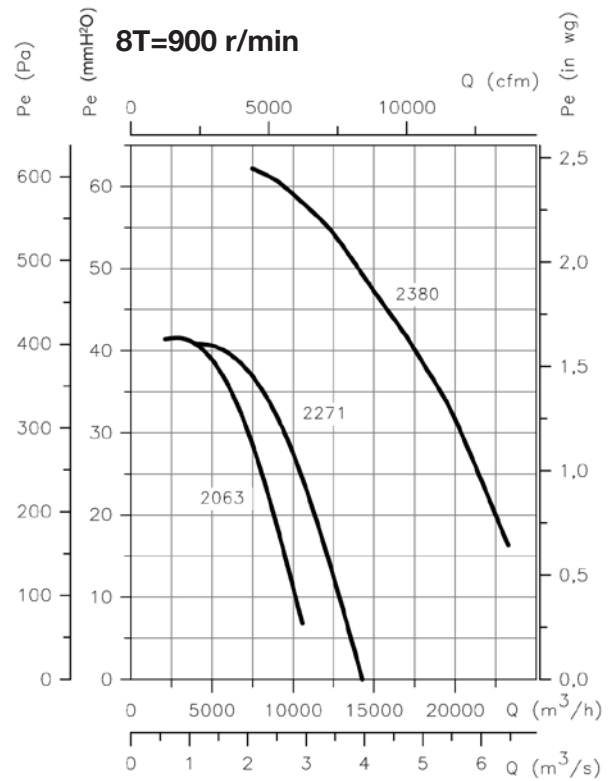
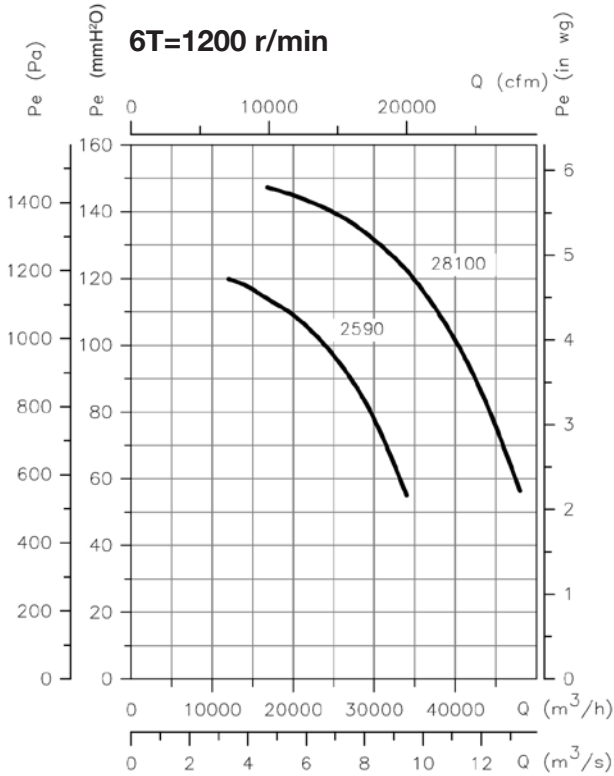

Orientaciones

Suministro standard LG 270

Modelos 2380, 2590 y 28100 orientación fija LG 270 (otras orientaciones sólo bajo demanda)



Accesorios



CMA

Ventiladores centrífugos de media presión y simple aspiración con envoltente y turbina en fundición de aluminio

Ventilador:

- Envoltente en fundición de aluminio
- Turbina en fundición de aluminio
- Modelos 324, 325 y 426 turbina en poliamida, modelo 531-2T-3 turbina en chapa de acero

Motor:

- Motores de eficiencia IE3 para potencias iguales o superiores a 0,75kW, excepto monofásicos, 2 velocidades y 8 polos.
- Motores clase F, con rodamientos a bolas, protección IP55, excepto modelos monofásicos protección IP54
- Motor Multitensión, diseño especial válido para: 220/380V 60Hz, 254/440V 60Hz, 265/460V 60Hz, 277/480V 60Hz
- Temperatura máxima del aire a transportar: -20°C.+ 120°C, máximo +70°C los modelos con turbina de poliamida

Acabado:

- Anticorrosivo en resina de poliéster polimerizada a 190 °C, previo desengrase con tratamiento nanotecnológico libre de fosfatos.

Bajo demanda:

- Bobinados especiales para diferentes tensiones
- Turbinas en fundición de aluminio para los modelos 324, 325 y 426
- Ventilador preparado para transportar aire hasta 250°C
- Certificación ATEX Categoría 2 (ver serie CMA/ATEX)



Posibilidad de diferentes posiciones de impulsión

Código de pedido

CMA — **531** — **2T** — **1,5** — **60Hz**

CMA: Ventiladores centrífugos de media presión y simple aspiración con envoltente y turbina en fundición de aluminio

Tamaño turbina

Número de polos motor
2=3500 r/min. 60 Hz

T=Trifásico
M=Monofásico

Potencia motor (c.v.)

Características técnicas

60Hz

Modelo	Velocidad (r/min)	Intensidad máxima admisible (A)		Potencia instalada (kW)	Caudal máximo (m³/h)	Nivel de presión sonora dB(A)	Peso aprox. (Kg)
		220-277V	380-480V				
CMA-218-2T	3504	0,61	0,35	0,09	265	63	6
CMA-218-2M	3504	0,6		0,09	265	63	6
CMA-324-2T	3420	1,21	0,7	0,18	440	70	9
CMA-324-2M	3420	1,5		0,18	440	70	9
CMA-325-2T	3336	1,64	0,95	0,25	600	73	11
CMA-325-2M	3336	2,2		0,25	600	73	11
CMA-426-2T	3318	1,78	1,03	0,37	850	75	13
CMA-426-2M	3318	2,95		0,37	850	75	13
CMA-527-2T	3360	2,42	1,4	0,55	1000	80	14,8
CMA-527-2M	3360	3,9		0,55	1000	80	14,8
CMA-528-2T-1	3336	3,12	1,8	0,75	1250	82	23,5
CMA-528-2M-1	3336	5,2		0,75	1250	82	23,5
CMA-528-2T-1,5	3420	4,42	2,55	1,1	1750	83	26
CMA-528-2M-1,5	3420	7,1		1,1	1750	83	26
CMA-531-2T-1,5	3456	4,42	2,55	1,1	1790	84	29
CMA-531-2M-1,5	3456	7,1		1,1	1790	84	29
CMA-531-2T-2	3420	5,89	3,4	1,5	2000	85	31
CMA-531-2M-2	3420	9,3		1,5	2000	85	31
CMA-531-2T-3	3360	8,23	4,75	2,2	2400	86	30
CMA-540-2T	3468	5,89	3,4	1,5	2600	85	38
CMA-545-2T-3	3408	8,23	4,75	2,2	2630	86	54
CMA-545-2T-4	3456	10,91	6,3	3	3550	88	64

Características acústicas

Espectro de potencia sonora Lw(A) en dB(A) por banda de frecuencia en Hz

Modelo	63	125	250	500	1000	2000	4000	8000	Modelo	63	125	250	500	1000	2000	4000	8000
218	29	43	61	67	71	68	63	54	531-1,5	50	64	82	88	92	89	84	75
324	36	50	68	74	78	75	70	61	531-2	51	65	83	89	93	90	85	76
325	39	53	71	77	81	78	73	64	531-3	52	66	84	90	94	91	86	77
426	41	55	73	79	83	80	75	66	540	54	67	85	91	96	92	87	79
527	46	60	78	84	88	85	80	71	545-3	55	68	86	92	97	93	88	80
528-1	48	62	80	86	90	87	82	73	545-4	57	70	88	94	99	95	90	82
528-1,5	49	63	81	87	91	88	83	74									

Dimensiones mm

CMA-218...531

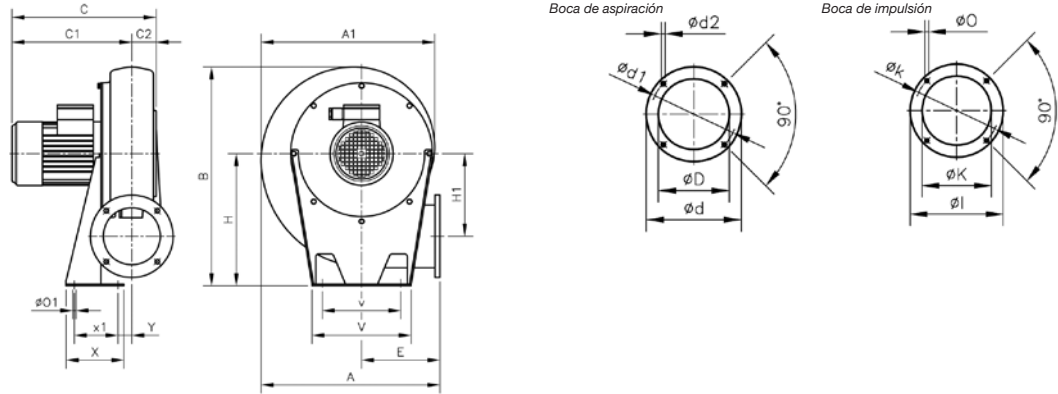

Modelo	A	A1	B	C	C1	C2	øD	ød	ød1	ød2	E	H	H1	øl	øK	øk	ø0	ø01	V	v	X	x1	Y
CMA-218	241	236	288	239	208	32	80	113	90	M5	110	170	114,5	90	54	76	5,5	7	140	100	80	50	20
CMA-324	311	302	356	268	202	38	80	130	112	M5	145	205	145	108	62	90	7	9	173	125	90	60	20
CMA-325	335	328	399	271	223	40	94	140	122	M6	155	235	152	120	80	102	7	9	180	145	110	80	20
CMA-426	354	344	412	291	250	40	117	155	132	M6	162	240	163	140	90	119	7	13	210	160	105	65	26
CMA-527	371	361	440	295	254	42	125	170	147	M6	168	260	170	155	100	129	7	13	220	170	120	80	20
CMA-528...1	401	395	488	340	289	51	116	190	162	M6	178	290	177	190	130	160	11	13	230	180	140	100	20
CMA-528...1'5	401	395	488	337	289	48	135	190	162	M6	178	290	177	190	130	160	11	13	230	180	140	100	20
CMA-531...1'5	440	434	537	341	290	50	160	215	180	M6	193	320	200	200	140	175	11	13	240	190	160	120	21
CMA-531...2	440	434	537	388	340	50	160	215	180	M6	193	320	200	200	140	175	11	13	240	190	160	120	21
CMA-531...3	440	434	537	388	350	50	160	215	180	M6	193	320	200	200	140	175	11	13	240	190	160	120	21

CMA-540-545

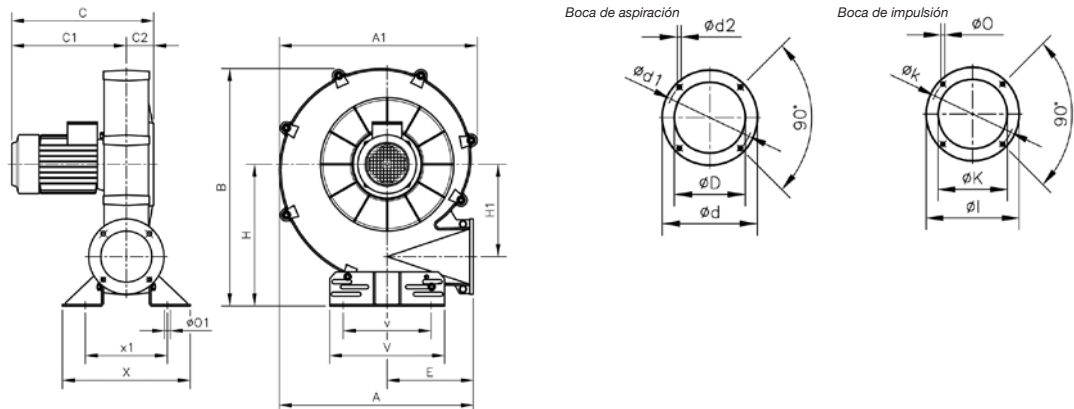

Modelo	A	A1	B	C	C1	C2	øD	ød	ød1	ød2	E	H	H1	øl	øK	øk	ø0	ø01	V	v	X	x1	Y
CMA-540	567	580	695	375	320	80	170	240	205	M10	252	415	270	220	150	190	13	11	336	218	374	240	-
CMA-545...3	651	646	776	423	344	115	180	255	220	M10	290	450	309	250	175	220	13	13	336	238	392	292	-
CMA-545...4	651	646	776	497	344	115	180	255	220	M10	290	450	309	250	175	220	13	13	336	238	392	292	-

Curvas características

Q= Caudal en m³/h, m³/s y cfm.

Pe= Presión estática en mmH₂O, Pa e inwg.

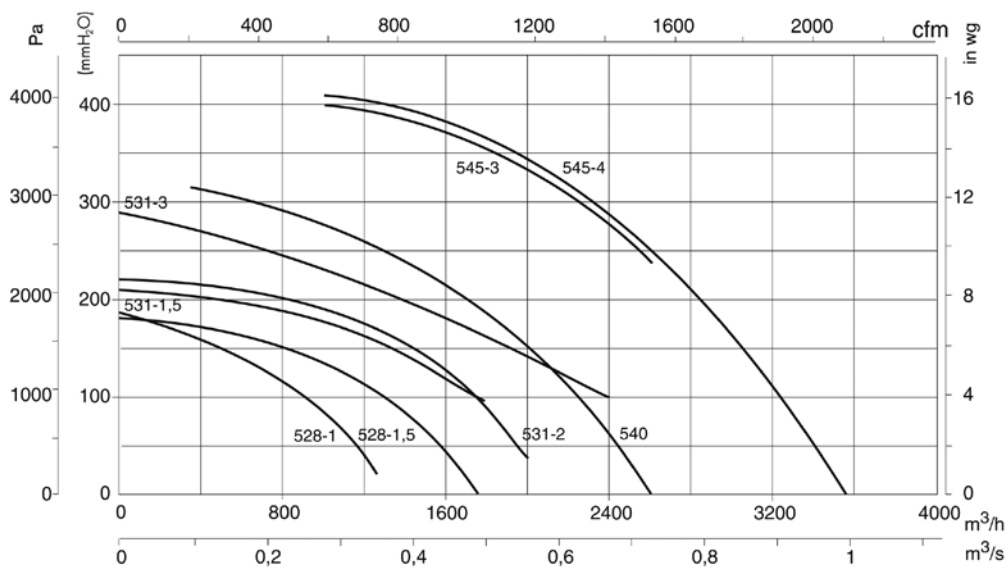
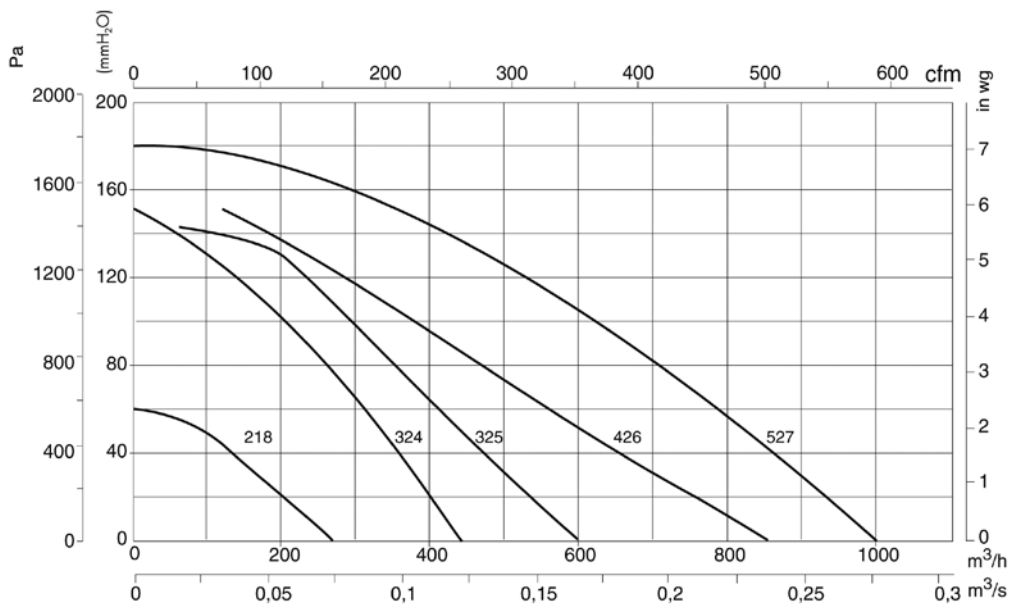

Orientaciones

Suministro standard LG 270

Posición LG 180 bajo demanda y con medidas de anclaje especiales



Accesorios



CPV

Ventiladores centrífugos anticorrosivos de simple aspiración fabricados en polipropileno



Estético y moderno diseño

Ventilador:

- Envoltente en polipropileno
- Turbina con álabes hacia delante, en polipropileno

Motor:

- Motores de eficiencia IE3 para potencias iguales o superiores a 0,75kW, excepto monofásicos, 2 velocidades y 8 polos.
- Motores clase F, con rodamientos a bolas, protección IP55
- Motor Multitensión, diseño especial válido para: 220/380V 60Hz, 254/440V 60Hz, 265/460V 60Hz, 277/480V 60Hz
- Temperatura máxima del aire a transportar: -20°C.+ 50°C.

Acabado:

- Anticorrosivo en material plástico

Bajo demanda:

- Bobinados especiales para diferentes tensiones
- Certificación ATEX Categoría 3

Código de pedido

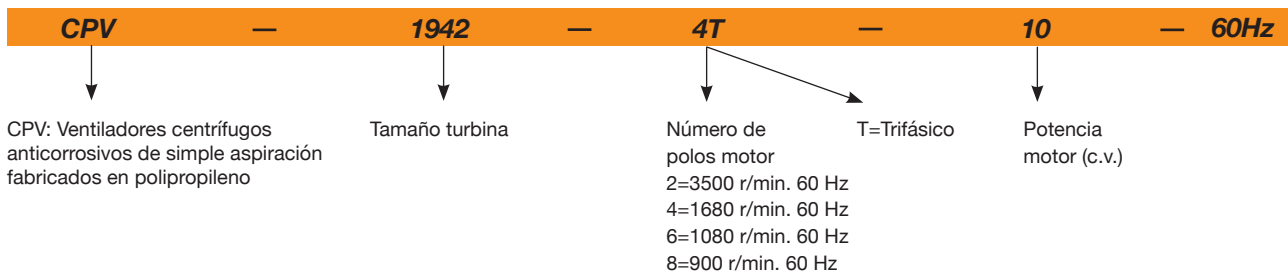

Características técnicas

60Hz

Modelo	Velocidad (r/min)	Intensidad máx admisible (A)		Potencia instalada (kW)	Caudal máximo (m³/h)	Nivel presión sonora dB(A)	Peso aprox. (Kg)
		220-277V	380-480V				
CPV-815-2T	3372	1,73	1	0,37	950	75	14
CPV-815-4T	1632	1,32	0,76	0,25	450	58	14
CPV-1020-2T	3360	3	1,73	0,75	2000	81	19,5
CPV-1020-4T	1632	1,32	0,76	0,25	1250	65	19,5
CPV-1020-6T	1056	1,67	0,96	0,25	750	53	19,5
CPV-1325-2T	3420	7,97	4,6	2,2	3250	87	27
CPV-1325-4T	1632	1,78	1,03	0,37	2300	69	27
CPV-1325-6T	1056	1,67	0,96	0,25	1400	59	27
CPV-1630-4T	1704	5,98	3,45	1,5	4500	75	34,5
CPV-1630-6T	1092	2,8	1,61	0,55	2700	63	34,5
CPV-1840-4T	1704	11,09	6,4	3	6000	70	48
CPV-1840-6T	1080	5,04	2,9	1,1	4200	65	42
*CPV-1942-4T-7,5	1740		11,4	5,5	8500	79	66
*CPV-1942-4T-10	1740		15,1	7,5	10500	84	77
*CPV-1942-6T	1116	9,32	5,36	2,2	7000	75	49
*CPV-1942-8T	852	7,1	4,08	1,5	5500	70	56
CPV-2045-4T	1740		15,1	7,5	10400	78	102
CPV-2045-6T	1140	12,2	7	3	7000	72	88
CPV-1335-2T	3498		14,7	5,5	4700	84	91
CPV-1160-4T	1752		21,5	11	8000	83	243
CPV-2060-4T	1752		21,5	11	12000	81	245
CPV-2160-4T	1746		28,5	15	15500	77	282
*CPV-720-2T	3408	1,82	1,05	0,37	525	75	10
*CPV-825-2T	3420	4,33	2,5	1,1	1140	79	17
*CPV-930-2T	3456	7,57	4,37	2,2	1750	84	24

*Sólo admiten orientación LG

Características acústicas

Espectro de potencia sonora Lw(A) en dB(A) por banda de frecuencia en Hz

Modelo	63	125	250	500	1000	2000	4000	8000	Modelo	63	125	250	500	1000	2000	4000	8000
815-2	56	69	77	81	81	77	73	65	1942-4-10	80	90	92	95	94	94	92	83
815-4	39	52	60	64	64	60	56	48	1942-6	71	81	83	86	85	85	83	74
1020-2	62	75	83	87	87	83	79	71	1942-8	66	76	78	81	80	80	78	69
1020-4	46	59	67	71	71	67	63	55	2045-4	63	76	84	88	89	85	81	72
1020-6	34	47	55	59	59	55	51	43	2045-6	57	70	78	82	83	79	75	66
1325-2	70	83	91	95	96	92	88	79	1335	67	80	88	92	93	89	85	76
1325-4	52	65	73	77	78	74	70	61	1160	68	81	89	93	94	90	86	77
1325-6	42	55	63	67	68	64	60	51	2060	66	79	87	91	92	88	84	75
1630-4	60	73	81	85	86	82	78	69	2160	64	77	85	89	89	85	81	73
1630-6	48	61	69	73	74	70	66	57	720	56	69	77	81	81	77	73	65
1840-4	55	68	76	80	81	77	73	64	825	60	73	81	85	85	81	77	69
1840-6	50	63	71	75	76	72	68	59	930	65	78	86	90	90	86	82	74
1942-4-7,5	75	85	87	90	89	89	87	78									

Dimensiones mm

CPV-720...1942

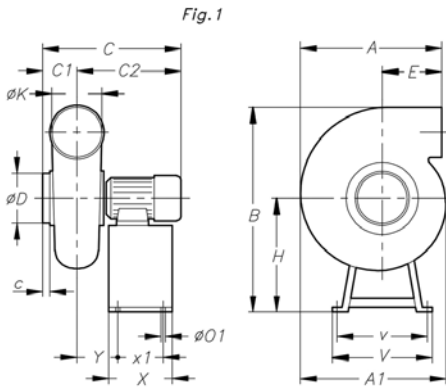

Modelo	Fig.	A	A1	B	C	C1	C2	c	øD	E	H	H1	øK	øO1	V	v	X	x1	Y
CPV-720	1	375	-	486	350	80	270	45	90	212	311	130	90	6	340	320	180	160	92
CPV-815	1	307	335	521	360	100	260	30	125	100	281	177,5	125	8	355	335	180	160	90
CPV-825	1	445	-	552	433	110	323	55	125	218	320	170	125	6	340	320	180	160	103
CPV-930	1	540	-	678	477	100	377	40	160	262	390	205	160	6	420	400	240	160	137
CPV-1020-2T	1	340	397	593	445,5	116	329,5	32	160	100	290	223	160	8	355	335	180	160	127,5
CPV-1020-4/6T	1	340	397	584	422,5	116	306,5	32	160	100	281	223	160	8	355	335	180	160	122,5
CPV-1325-2T	1	413	505	735	494	130	364	35	200	103	370	265	200	8	400	380	180	160	125
CPV-1325-4/6T	1	413	505	716	432,5	130	302,5	35	200	103	351	265	200	8	400	380	180	160	113,5
CPV-1630-4T	1	480	602	890	536,5	145	391,5	35	250	117	440	323	250	8	450	430	240	220	142,5
CPV-1630-6T	1	480	602	880	503	145	358	35	250	117	430	323	250	8	450	430	240	220	138
CPV-1942-4T	1	580	750	1170	730,5	210	520,5	60	315	130	600	412,5	315	8	600	564	350	314	181,5
CPV-1942-6/8T	1	580	750	1150	679,5	210	469,5	60	315	130	580	412,5	315	8	600	564	350	314	204

CPV-1030...2045

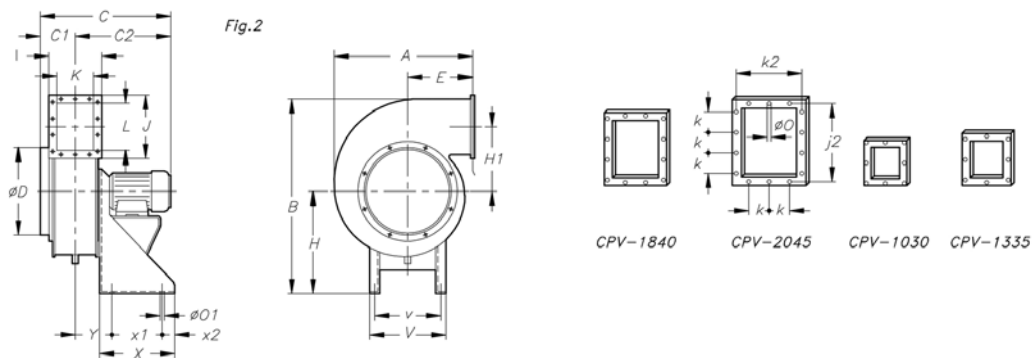

Modelo	Fig.	A	B	C	C1	C2	øD	E	H	H1	I	J	J2	øK	k	k2	L	øO	øO1	V	v	X	x1	x2	Y
CPV-1335	2	566	788	-	175	-	225	255	452	246	240	256	226	160	100	210	180	9	12	320	285	-	200	50	140
CPV-1840-4T	2	628	819	660	210	450	355	275	420	259	305	356	326	225	100	275	280	9	12	320	285	300	200	50	170
CPV-1840-6T	2	628	809	630	210	420	355	275	410	259	305	356	326	225	100	275	280	9	12	320	285	300	200	50	170
CPV-2045	2	724	1020	810	245	565	400	300	542	310	362	421	381	270	100	322	335	9	12	350	315	350	250	50	197

Dimensiones mm

CPV-1160...2160

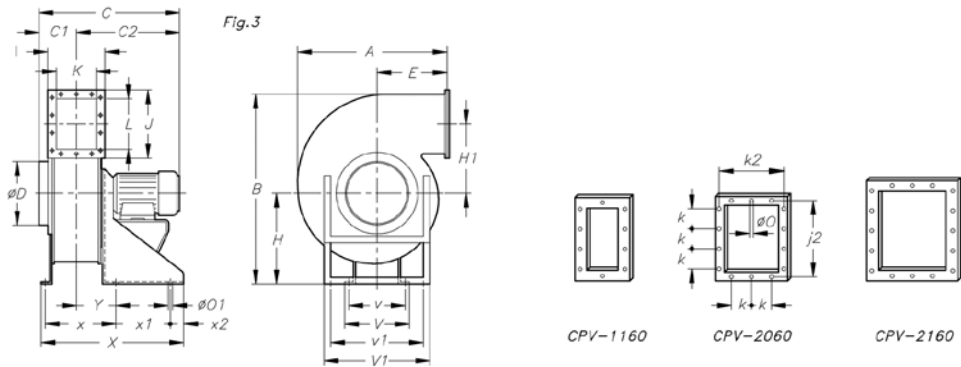

Modelo	Fig.	A	B	C	C1	C2	øD	E	H	H1	I	J	J2	øK	k	k2	L	øO	øO1	V	V1	v	v1	X	x	x1	x2	Y
CPV-1160	3	937	1276	-	210	-	355	410	720	421	275	416	366	155	100	225	310	9	14	500	790	450	670	710	265	360	60	155
CPV-2060	3	937	1276	-	270	-	400	410	720	421	395	416	366	275	100	345	310	9	14	500	790	450	670	855	410	360	60	215
CPV-2160	3	981	1336	-	285	-	600	414	720	438,5	455	501	451	335	100	405	395	9	14	500	790	450	670	915	470	360	60	240

Curvas características

Q= Caudal en m³/h, m³/s y cfm.

Pe= Presión estática en mmH₂O, Pa e inwg.

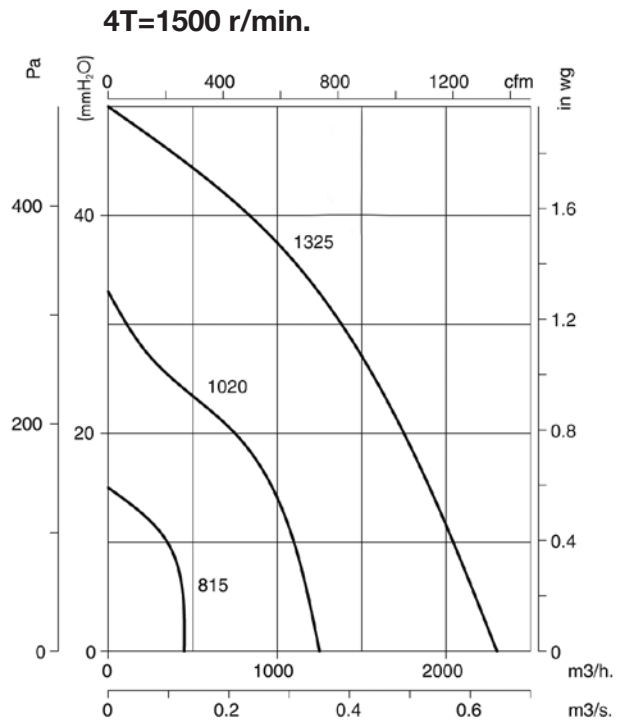
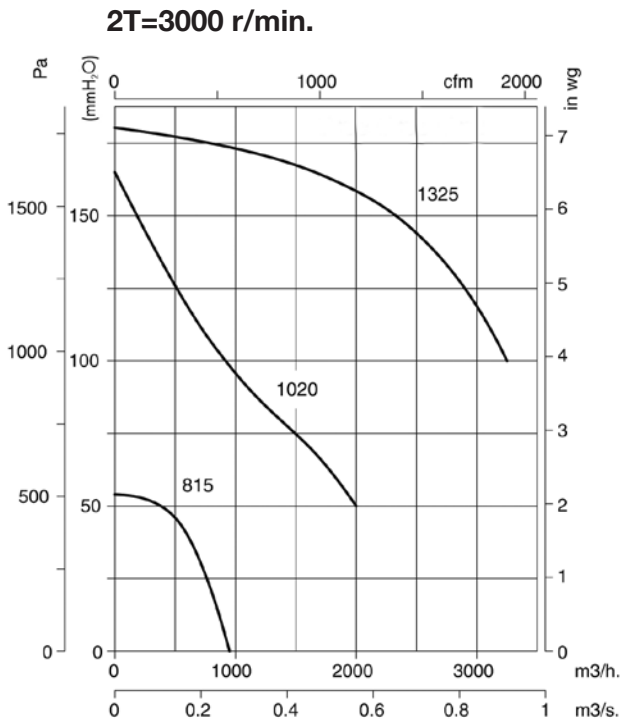

Curvas características

Q= Caudal en m³/h, m³/s y cfm.

Pe= Presión estática en mmH₂O, Pa e inwg.

4T=1500 r/min.

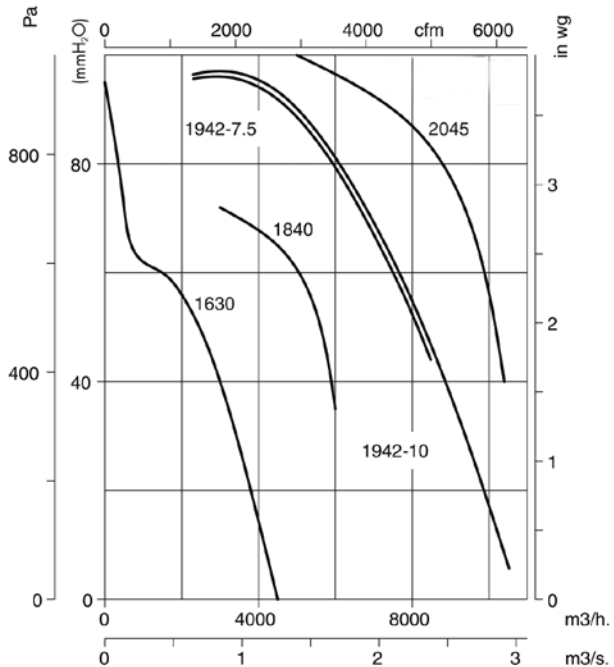

6T=1000 r/min. 8T=750 r/min

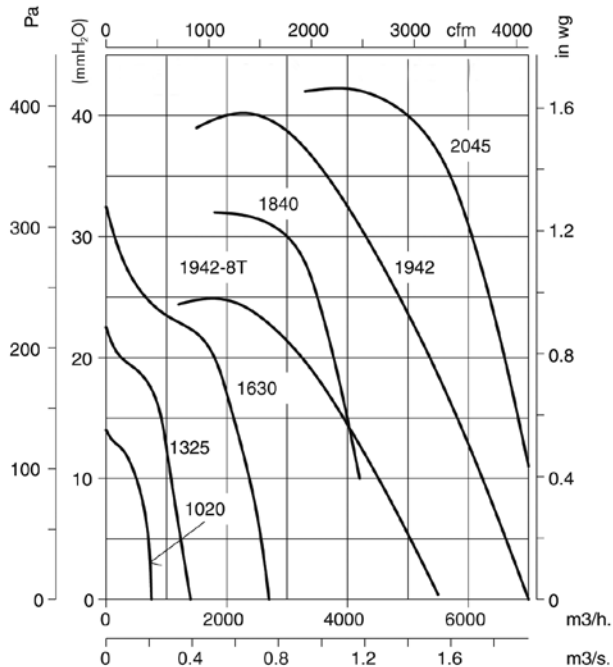

2T=3000 r/min. 4T=1500 r/min

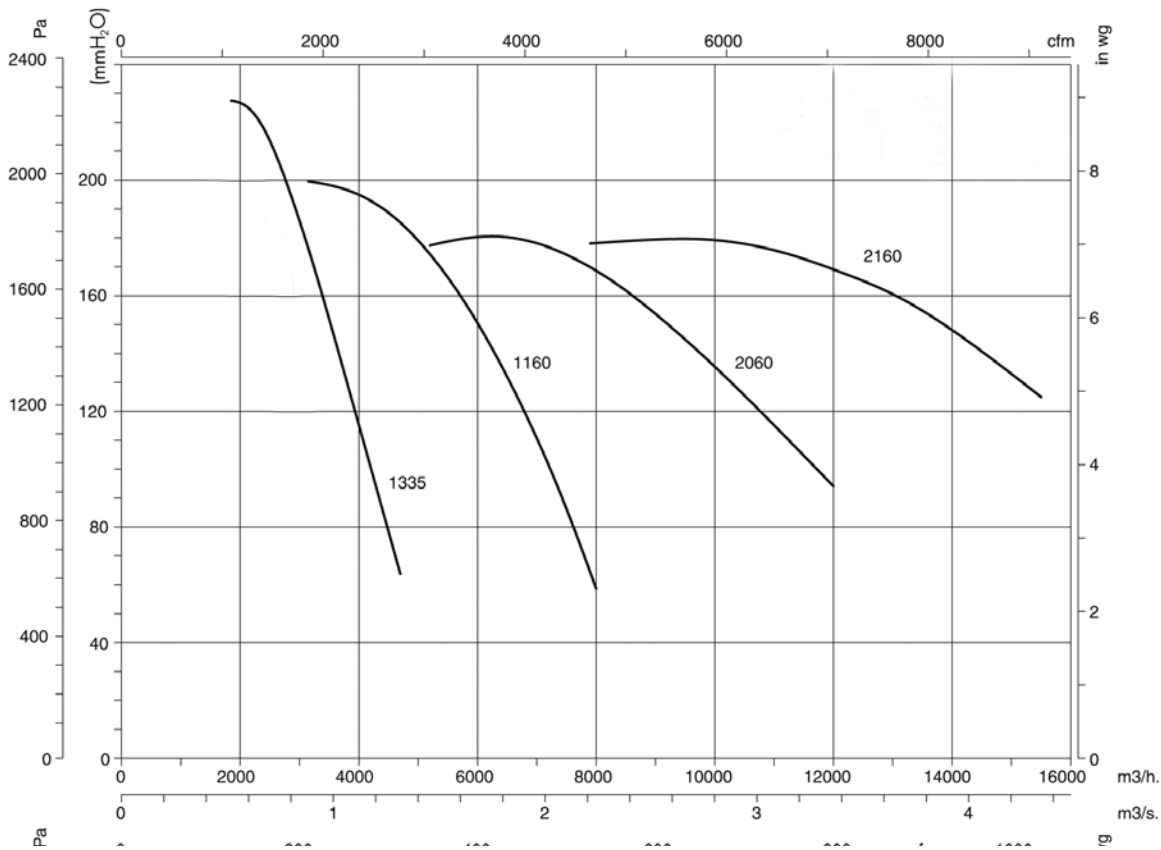

Curvas características

Q= Caudal en m³/h, m³/s y cfm.

Pe= Presión estática en mmH₂O, Pa e inwg.

2T=3000 r/min.

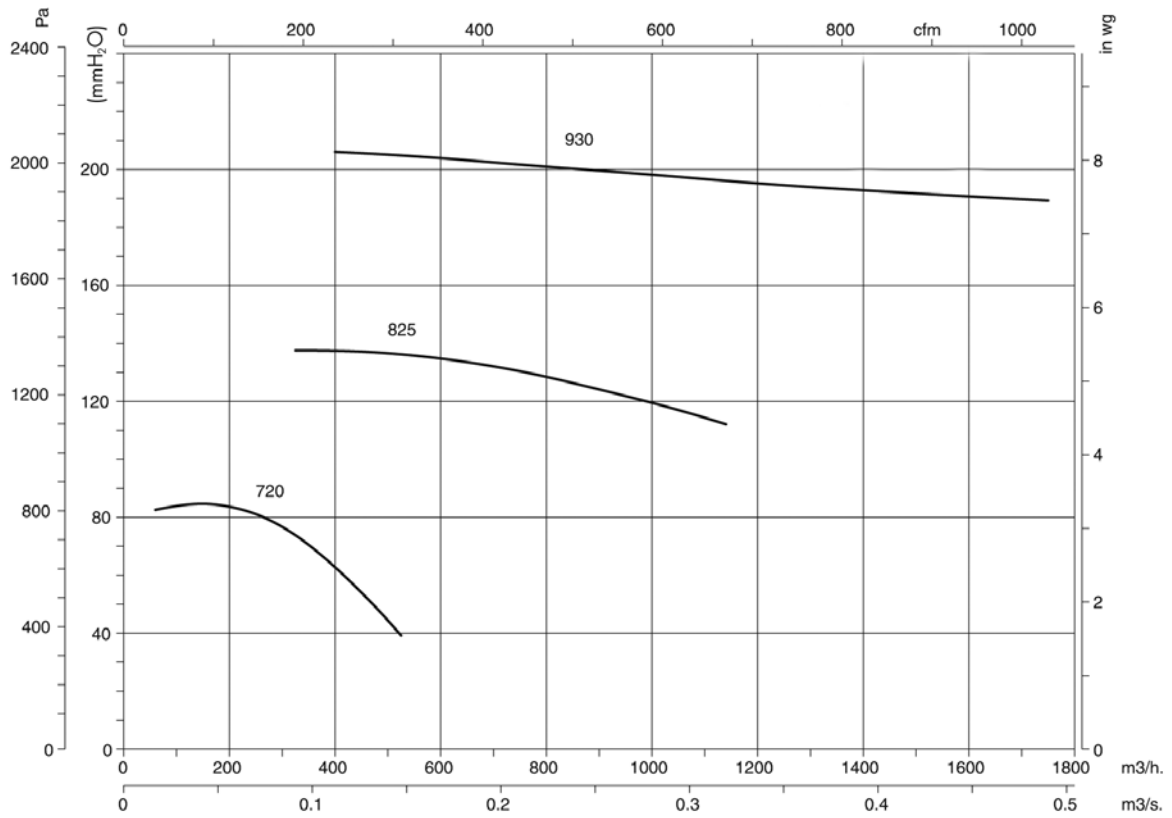

Orientaciones

Suministro standard LG 90



Accesorios



CA

Ventiladores centrífugos de alta presión y simple aspiración con envoltorio y turbina en fundición de aluminio



Ventilador:

- Envoltorio en fundición de aluminio
- Turbina en fundición de aluminio

Motor:

- Motores de eficiencia IE3 para potencias iguales o superiores a 0,75kW, excepto monofásicos, 2 velocidades y 8 polos.
- Motores clase F, con rodamientos a bolas, protección IP55
- Motor Multitensión, diseño especial válido para: 220/380V 60Hz, 254/440V 60Hz, 265/460V 60Hz, 277/480V 60Hz
- Temperatura máxima del aire a transportar: -20°C.+ 120°C.

Acabado:

- Anticorrosivo en resina de poliéster polimerizada a 190 °C, previo desengrase con tratamiento nanotecnológico libre de fosfatos.

Bajo demanda:

- Bobinados especiales para diferentes tensiones
- Ventilador preparado para transportar aire hasta 250°C
- Certificación ATEX Categoría 2

Construcción en aluminio de gran espesor para absorber ruidos y vibraciones

Código de pedido

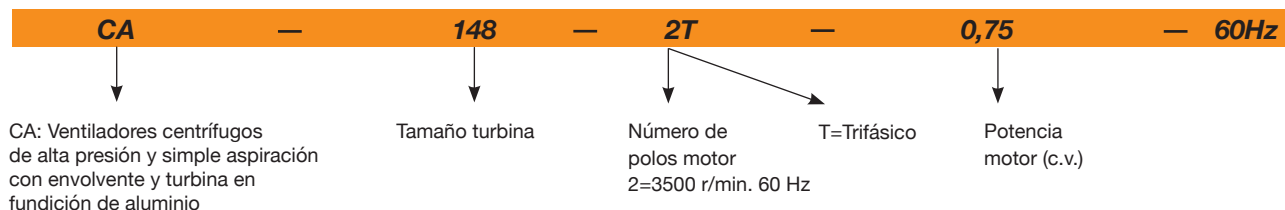

Características técnicas

60Hz

Modelo	Velocidad (r/min)	Intensidad máx admisible (A)		Potencia instalada (kW)	Caudal máximo (m³/h)	Nivel presión sonora dB(A)	Peso aprox. (Kg)
		220-277V	380-480V				
CA-234-2T	3444	1,92	1,11	0,37	220	72	10,2
CA-234-2M	3444	2,53		0,37	220	72	10,2
CA-142-2T-0,33	3282	1,29	0,75	0,25	275	73	22,5
CA-142-2T-0,5	3372	1,92	1,11	0,37	350	73	22,5
CA-148-2T-0,75	3396	2,57	1,49	0,55	400	74	28,0
CA-148-2T-1	3408	2,78	1,60	0,75	490	75	30,0
CA-148-2T-1,5	3420	4,20	2,40	1,10	610	76	32,0
CA-154-2T-1,5	3396	4,20	2,40	1,10	600	78	46,0
CA-154-2T-2	3432	5,44	3,13	1,50	800	79	48,5
CA-154-2T-3	3450	7,77	4,47	2,20	1280	80	50,5
CA-160-2T-2	3420	5,44	3,13	1,50	500	83	57,0
CA-160-2T-3	3432	7,77	4,47	2,20	900	84	58,0
CA-166-2T-3	3444	7,77	4,47	2,20	500	84	67,0
CA-166-2T-4	3444	10,18	5,88	3,00	950	85	73,0
CA-166-2T-5,5	3432	13,60	7,82	4,00	1600	86	76,0
CA-172-2T-5,5	3456	13,60	7,82	4,00	1100	87	90,0
CA-172-2T-7,5	3456		10,50	5,50	1710	88	112,0
CA-172-2T-10	3516		14,50	7,50	2300	89	124,0

Características acústicas

Espectro de potencia sonora Lw(A) en dB(A) por banda de frecuencia en Hz

Modelo	63	125	250	500	1000	2000	4000	8000	Modelo	63	125	250	500	1000	2000	4000	8000
234	38	51	65	72	80	79	73	64	160-2	54	67	81	88	96	94	88	80
142	39	52	66	73	81	80	74	65	160-3	55	68	82	89	97	95	89	81
148-0,75	43	56	70	77	85	83	77	69	166-3	55	68	82	89	97	95	89	81
148-1	44	57	71	78	86	84	78	70	166-4	56	69	83	90	98	96	90	82
148-1,5	45	58	72	79	87	85	79	71	166-5,5	57	70	84	91	99	97	91	83
154-1,5	47	60	74	81	89	87	81	73	172-5,5	59	72	86	93	101	100	94	85
154-2	48	61	75	82	90	88	82	74	172-7,5	60	73	87	94	102	101	95	86
154-3	49	62	76	83	91	89	83	75	172-10	61	74	88	95	103	102	96	87

Dimensiones mm

CA-234

Modelo	A	A1	B	C	C1	C2	øD	ød	ød1	ød2	E	H	H1	I	J	øK	k	øO	øO1	V	v	x1	Y
CA-234-2T-0,33	376	381	415	272	242,5	29,5	98	130	115	M4	175	225	187	98	63	40	72	9	9	180	120	40	94
CA-234-2M-0,33	376	381	415	272	242,5	29,5	98	130	115	M4	175	225	187	98	63	40	72	9	9	180	120	40	94

CA-142...172

Modelo	A	A1	B	C	C1	C2	øD	ød	ød1	ød2	E	H	H1	I	J	øK	øk	øO	øO1	V	v	x1	Y
CA-142-2T-0'33	494	488	540	270	221,52	48,5	90	160	130	M8	240	301	235	120	60	90	11	12	300	270	130	51	
CA-142-2T-0'5	494	488	540	290	241,5	48,5	90	160	130	M8	240	301	235	120	60	90	11	12	300	270	130	51	
CA-142-2T-0'75	563	557,5	639	308,5	251,5	57	100	170	140	M8	270	360	269,5	150	73	110	11	12	330	290	140	60	
CA-148-2T-1	563	557,5	639	324,5	267,5	57	100	170	140	M8	270	360	269,5	150	73	110	11	12	330	290	140	60	
CA-148-2T-1'5	563	557,5	639	324,5	267,5	57	100	170	140	M8	270	360	269,5	150	73	110	11	12	330	290	140	60	
CA-154-2T-1'5	630	625	708	348	268,5	79,5	115	183	155	M10	300	395	308	160	80	120	13	12	356	320	210	62	
CA-154-2T-2	630	625	708	371	291,5	79,5	115	183	155	M10	300	395	308	160	80	120	13	12	356	320	210	62	
CA-154-2T-3	630	625	708	396	316,5	79,5	115	183	155	M10	300	395	308	160	80	120	13	12	356	320	210	62	
CA-160-2T-2	708	699	785	381	291	90	130	230	192	M10	336	440	338	160	85	120	13	12	373	322	220	62	
CA-160-2T-3	708	699	785	406	316	90	130	230	192	M10	336	440	338	160	85	120	13	12	373	322	220	62	
CA-166-2T-3	759	752	866	399	319,5	79,5	140	230	200	M10	364	490	372	160	85	120	13	12	450	400	245	70	
CA-166-2T-4	759	752	866	423	343,5	79,5	140	230	200	M10	364	490	372	160	85	120	13	12	450	400	245	70	
CA-166-2T-5'5	759	752	866	445	365,5	79,5	140	230	200	M10	364	490	372	160	85	120	13	12	450	400	265	70	
CA-172-2T-5'5	818	813	923	451	371	80	148	230	200	M10	390	516	404	175	90	140	13	12	450	400	260	78	
CA-172-2T-7'5	818	813	923	492	412	80	148	230	200	M10	390	516	404	175	90	140	13	12	450	400	300	78	
CA-172-2T-10	818	813	923	492	412	80	148	230	200	M10	390	516	404	175	90	140	13	12	450	400	300	78	

Curvas Características

Q= Caudal en m³/h, m³/s y cfm.

Pe= Presión estática en mmH₂O, Pa e inwg.

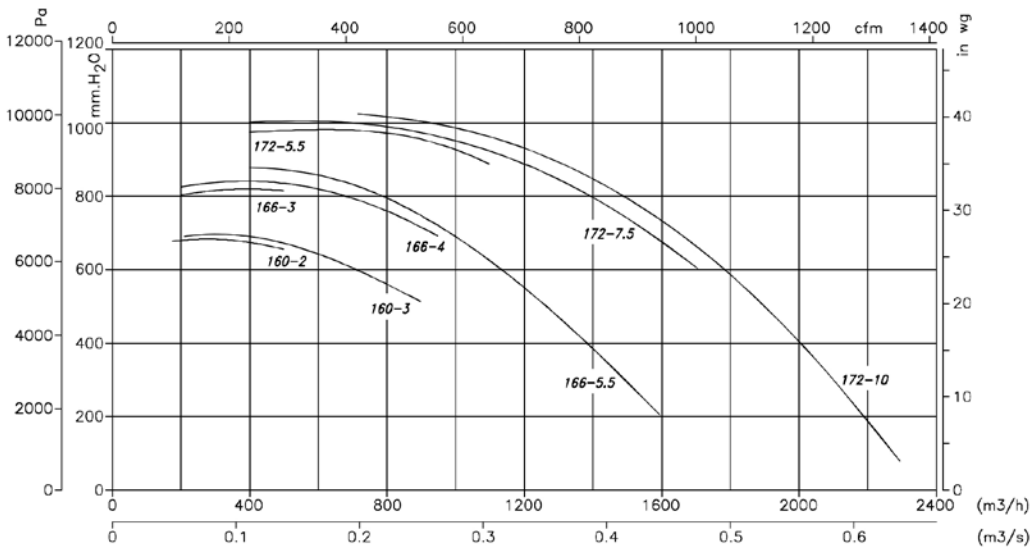
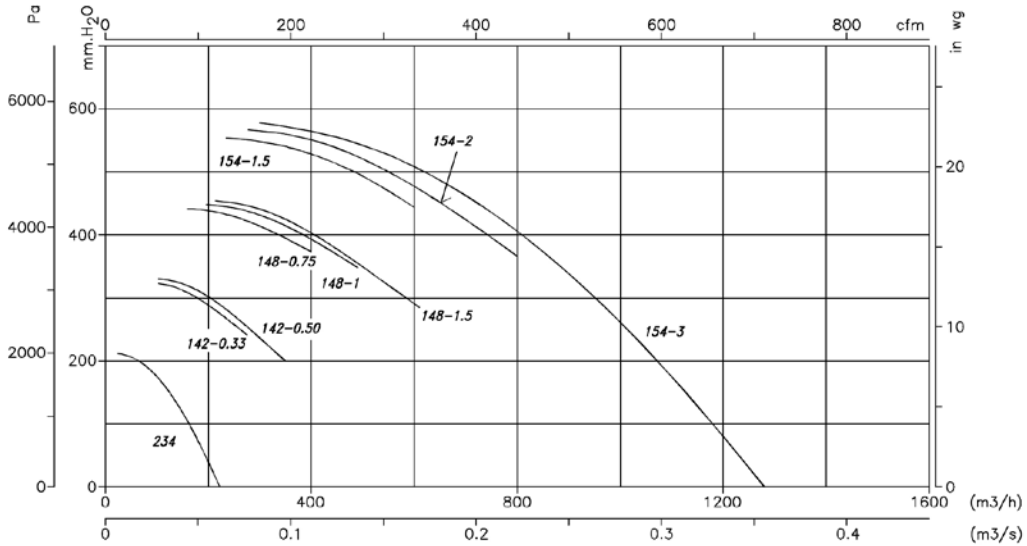

Orientaciones

Suministro standard LG 270

Posiciones LG 180 bajo demanda y con medidas de anclaje especiales.



Accesorios

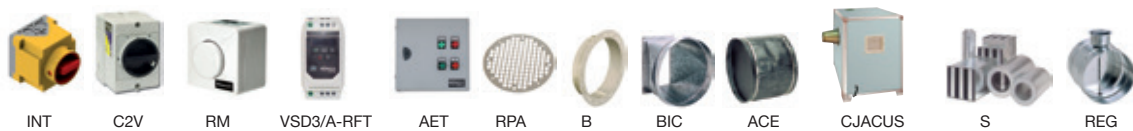

CAS CAS-S



CAS: Ventiladores centrífugos de alta presión y simple aspiración con envolvente y turbina en chapa de acero

CAS-S: Ventiladores centrífugos de alta presión y simple aspiración con envolvente y turbina en chapa de acero, equipado con atenuador acústico

Ventilador:

- Envolvente en chapa de acero
- Turbina con álabes hacia atrás, en chapa de acero galvanizado, excepto modelos 242-248-254-260-640-645-650 en turbina en fundición de aluminio
- CAS-S: Atenuador acústico de perfil hexagonal incorporado en la boca de aspiración del ventilador. Su diseño permite ajustar el caudal de aire en la entrada del ventilador

Motor:

- Motores de eficiencia IE3 para potencias iguales o superiores a 0,75kW, excepto monofásicos, 2 velocidades y 8 polos.
- Motores clase F, con rodamientos a bolas, protección IP55
- Motor Multitensión, diseño especial válido para: 220/380V 60Hz, 254/440V 60Hz, 265/460V 60Hz, 277/480V 60Hz
- Temperatura máxima del aire a transportar: -20°C.+ 120°C.

Acabado:

- Anticorrosivo en resina de poliéster polimerizada a 190 °C, previo desengrase con tratamiento nanotecnológico libre de fosfatos.

Bajo demanda:

- Bobinados especiales para diferentes tensiones
- Ventilador preparado para transportar aire hasta 250°C
- Ventilador en acero inoxidable
- Certificación ATEX Categoría 2

Código de pedido

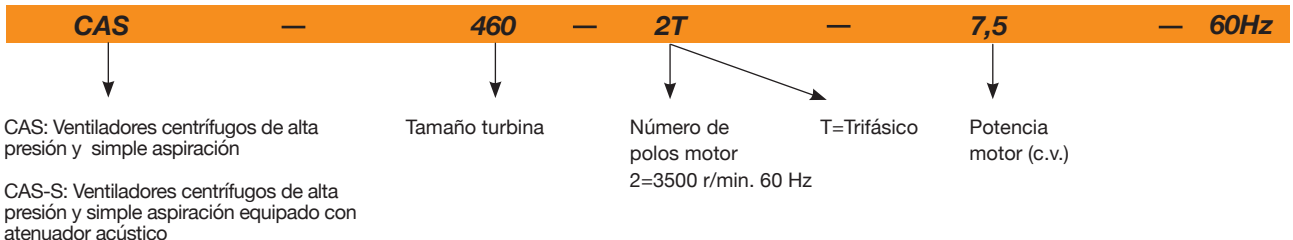

Características técnicas

60Hz

Modelo	Velocidad (r/min)	Intensidad máx admisible (A)		Potencia instalada (kW)	Caudal máximo (m³/h)	Nivel presión sonora dB(A)		Peso aprox. (Kg)	
		220-277V	380-480V			CAS	CAS-S	CAS	CAS-S
CAS-242-2T-0,33	3396	1,39	0,8	0,25	450	73	67	30	33
CAS-242-2T-0,5	3288	1,92	1,11	0,37	650	73	67	31	34
CAS-248-2T-0,75	3360	2,42	1,4	0,55	420	74	68	43,5	46,5
CAS-248-2T-1	3426	3	1,73	0,75	500	75	69	45	48
CAS-248-2T-1,5	3414	4,16	2,4	1,1	990	76	70	46,5	49,5
CAS-254-2T-1,5	3414	4,16	2,4	1,1	600	76	70	56,5	59,5
CAS-254-2T-2	3432	5,63	3,25	1,5	800	78	72	61,5	64,5
CAS-254-2T-3	3456	7,97	4,6	2,2	1300	80	73	63	66
CAS-260-2T-2	3432	5,63	3,25	1,5	500	77	71	75	80
CAS-260-2T-3	3456	7,97	4,6	2,2	900	79	72	78	83
CAS-463-2T-5,5	3480	13,34	7,7	4	1150	82	75	88,5	93,5
CAS-463-2T-7,5	3426		10,5	5,5	2000	83	76	95,5	100,5
CAS-467-2T-7,5	3426		10,5	5,5	1550	84	77	117,5	122,5
CAS-467-2T-10	3426		13,9	7,5	2600	85	78	122,5	127,5
CAS-571-2T-10	3426		13,9	7,5	2000	86	78	144	149
CAS-571-2T-15	3516		20	11	3450	87	79	175	180

Características técnicas

Modelo	Velocidad (r/min)	Intensidad máx admisible (A)		Potencia instalada (kW)	Caudal máximo (m³/h)	Nivel presión sonora dB(A)		Peso aprox. (Kg)	
		220-277V	380-480V			CAS	CAS-S	CAS	CAS-S
CAS-640-2T-2	3432	5,63	3,25	1,5	2600	77	71	51,5	56,5
CAS-645-2T-3	3456	7,97	4,6	2,2	2000	76	70	62,5	70,5
CAS-645-2T-4	3474	10,57	6,1	3	3000	81	74	69,5	77,5
CAS-650-2T-5,5	3480	13,34	7,7	4	3500	81	74	89	97
CAS-650-2T-7,5	3426		10,5	5,5	4750	83	76	96	104
CAS-852-2T-7,5	3426		10,5	5,5	3500	81	74	96	104
CAS-852-2T-10	3426		13,9	7,5	5500	85	78	101	109
CAS-856-2T-15	3516		20	11	7500	85	78	157,5	167,5
CAS-863-2T-15	3516		20	11	4000	84	77	168	178
CAS-863-2T-20	3504		26,5	15	7000	86	78	179	189
CAS-971-2T-25	3504		32	18,5	5800	87	79	299	309
CAS-971-2T-30	3516		39	22	8100	88	80	324	334
CAS-971-2T-40	3546		53	30	12000	89	81	380	390
CAS-1250-2T-15/A	3516		20	11	12000	84	77	220	230
CAS-1456-2T-25/A	3504		32	18,5	18000	87	79	286	299
CAS-1663-2T-50/A	3540		64	37	25000	92	84	425	438
CAS-1671-2T-60/A	3528		80	45	27000	93	85	575	590
CAS-2071-2T-100/A	3564		127	75	33600	95	86	750	770
CAS-2080-2T-125/A	3564		152	90	42600	96	87	820	840
CAS-790-2T-20	3504		26,5	15	2100	88	80	245	250
CAS-980-2T-30	3516		39	22	4800	87	79	340	355
CAS-990-2T-50	3540		64	37	6000	90	82	485	500
CAS-1080-2T-40	3546		53	30	5400	88	80	420	435
CAS-1090-2T-60	3552		79	45	6000	91	83	530	545

Características acústicas

Espectro de potencia sonora Lw(A) en dB(A) por banda de frecuencia en Hz

Modelo	63	125	250	500	1000	2000	4000	8000	Modelo	63	125	250	500	1000	2000	4000	8000
CAS									852-7,5								
242	50	61	67	76	83	82	79	72	852-10	68	76	86	93	96	96	92	84
248-0,75	51	62	68	77	84	83	80	73	856	63	76	90	96	96	94	90	84
248-1	52	63	69	78	85	84	81	74	863-15	67	81	87	96	96	95	92	87
248-1,5	53	64	70	79	86	85	82	75	863-20	69	81	92	99	98	95	93	87
254-1,5	55	66	71	81	88	87	84	77	971-25	67	81	90	102	98	96	93	89
254-2	57	68	73	83	90	89	86	79	971-30	68	82	91	103	99	97	94	90
254-3	56	68	76	85	90	92	89	82	971-40	68	83	97	102	102	99	95	88
260-2	53	69	69	83	88	88	85	78	1250	75	88	97	94	91	86	82	73
260-3	55	71	71	85	90	90	87	80	1456	80	93	102	99	96	90	87	78
463-5,5	57	69	82	91	93	93	89	80	1663	65	74	80	95	108	100	97	93
463-7,5	58	70	83	92	94	94	90	81	1671	64	73	79	94	108	100	97	93
467-7,5	69	74	83	95	95	97	93	85	2071	66	75	81	96	110	102	99	95
467-10	70	75	84	96	96	98	94	86	2080	67	76	82	97	111	103	100	96
571-10	64	76	86	96	99	99	94	86	680	70	74	85	96	102	93	86	80
571-15	65	77	87	97	100	100	95	87	790	73	77	88	99	105	96	89	83
640	56	67	75	82	88	84	83	76	980	61	70	76	91	105	97	94	90
645-3	55	66	74	81	87	83	82	75	990	64	73	79	94	108	100	97	93
645-4	55	66	77	86	90	91	87	79	1080	62	71	77	92	106	98	95	91
650-5,5	59	75	84	90	93	90	85	78	1090	65	77	80	95	109	101	98	94
650-7,5	52	68	81	91	96	93	85	78									

Modelo	63	125	250	500	1000	2000	4000	8000	Modelo	63	125	250	500	1000	2000	4000	8000
CAS-S									852-7,5								
242	44	55	61	70	77	76	73	66	852-10	61	65	75	81	85	85	82	77
248-0,75	45	56	62	71	78	77	74	67	856	61	69	79	86	89	89	85	77
248-1	46	57	63	72	79	78	75	68	863-15	56	69	83	89	89	87	83	77
248-1,5	47	58	64	73	80	79	76	69	863-20	60	74	80	89	89	88	85	80
254-1,5	49	60	65	75	82	81	78	71	863-20	61	73	84	91	90	87	85	79
254-2	51	62	67	77	84	83	80	73	971-25	59	73	82	94	90	88	85	81
254-3	49	61	69	78	83	85	82	75	971-30	60	74	83	95	91	89	86	82
260-2	47	63	63	77	82	82	79	72	971-40	60	75	89	94	94	91	87	80
260-3	48	64	64	78	83	83	80	73	1250	68	81	90	87	84	79	75	66
463-5,5	50	62	75	84	86	86	82	73	1456	72	85	94	91	88	82	79	70
463-7,5	51	63	76	85	87	87	83	74	1663	57	66	72	87	100	92	89	85
467-7,5	62	67	76	88	88	90	86	78	1671	56	65	71	86	100	92	89	85
467-10	63	68	77	89	89	91	87	79	2071	57	66	72	87	101	93	90	86
571-10	56	68	78	88	91	91	86	78	2080	58	67	73	88	102	94	91	87
571-15	57	69	79	89	92	92	87	79	680	62	66	77	88	94	85	78	72
640	50	61	69	76	82	78	77	70	790	65	69	80	91	97	88	81	75
645-3	49	60	68	75	81	77	76	69	980	53	62	68	83	97	89	86	82
645-4	48	59	70	79	83	84	80	72	990	56	65	71	86	100	92	89	85
650-5,5	52	68	77	83	86	83	78	71	1080	54	63	69	84	98	90	87	83
650-7,5	45	61	74	84	89	86	78	71	1090	57	66	72	87	101	93	90	86

Dimensiones mm

CAS-242...971

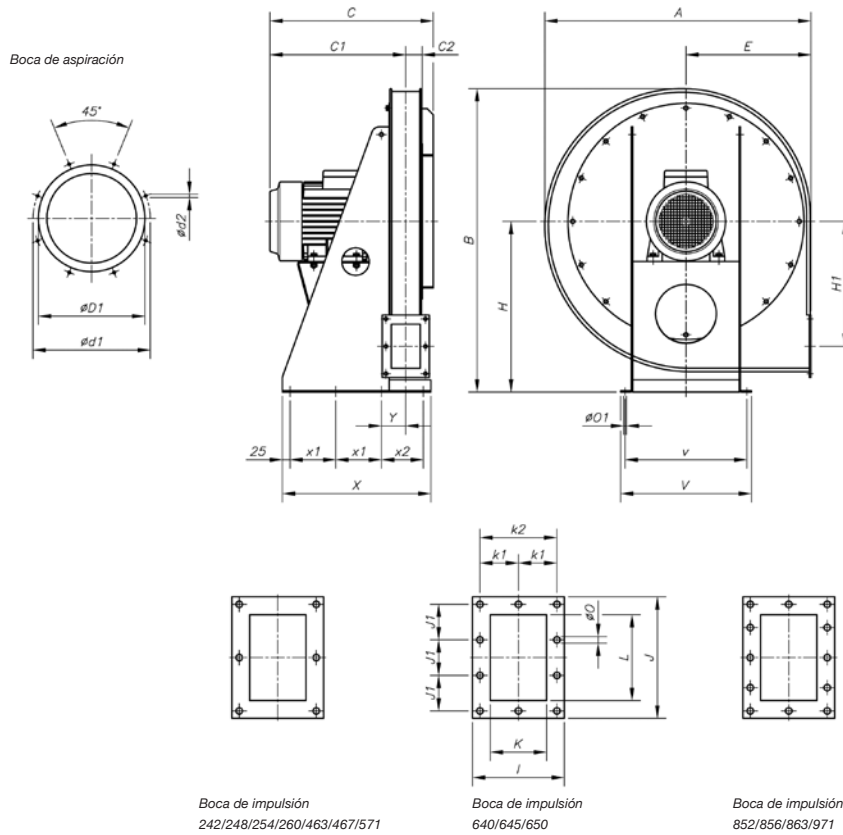

Modelo	A	B	C	C1	C2	øD1	ød1	øD2	E	H	H1	I	J	J1	K	k1	k2	L	øD	øD1	V	v	X	x1	x2	Y
CAS-242-2T-0'33	576	662	282	219	33	100	130	M8	270	375	270	120	155	65	60	-	95	95	11	12	305	275	260	75	-	61
CAS-242-2T-0'5	576	662	310	247	33	100	130	M8	270	375	270	120	155	65	60	-	95	95	11	12	305	275	260	75	-	61
CAS-248-2T-0'75	639	728	315	249	36	112	140	M8	300	410	297	126	165	70	66	-	101	105	11	12	320	290	300	90	-	64
CAS-248-2T-1'1'5	639	728	340	274	36	112	140	M8	300	410	297	126	165	70	66	-	101	105	11	12	320	290	300	90	-	64
CAS-254-2T-1'5	699	788	365	294,5	40,5	125	155	M8	330	440	322	135	175	75	75	-	110	115	11	14	340	310	330	100	-	68,5
CAS-254-2T-2	699	788	413	342,5	40,5	125	155	M8	330	440	322	135	175	75	75	-	110	115	11	14	340	310	330	100	-	68,5
CAS-254-2T-3	699	788	443	372,5	40,5	125	155	M8	330	440	322	135	175	75	75	-	110	115	11	14	340	310	330	100	-	68,5
CAS-260-2T-2'3	782	875	419	343,5	47,5	150	175	M8	370	485	362	145	185	80	85	-	120	125	11	14	380	350	370	115	-	73,5
CAS-463-2T-5'5	782	875	459	383,5	45,5	200	240	M8	370	485	362	145	185	80	85	-	120	125	11	14	380	350	370	115	-	73,5
CAS-463-2T-7'5	782	875	517	441,5	45,5	200	240	M8	370	485	362	145	185	80	85	-	120	125	11	14	380	350	370	115	-	73,5
CAS-467-2T-7'5/10	833	945	530	442	48	224	258	M8	390	530	395	150	190	82,5	90	-	125	130	11	14	405	375	300	125	-	76
CAS-571-2T-10	873	995	536	445,5	50,5	250	275	M8	410	560	410	155	205	90	95	-	130	145	11	14	430	400	350	150	-	79,5
CAS-571-2T-15	873	995	671	580,5	50,5	250	275	M8	410	560	410	155	205	90	95	-	130	145	11	14	430	400	410	180	-	79,5
CAS-640-2T-2	639	728	446	350,5	65,5	250	275	M8	300	410	250	185	260	78	125	80	-	200	11	14	340	310	350	100	-	93,5
CAS-645-2T-3	699	788	461	358	73	250	275	M8	330	440	267,5	200	284	86	140	87,5	-	224	11	14	380	350	380	115	-	101
CAS-645-2T-4	699	788	491	388	73	250	275	M8	330	440	267,5	200	284	86	140	87,5	-	224	11	14	380	350	380	115	-	101
CAS-650-2T-5'5	782	875	534	421	83	250	275	M8	370	485	300	220	310	95	160	97,5	-	250	11	14	405	375	490	125	190	111
CAS-650-2T-7'5	782	875	572	459	83	250	275	M8	370	485	300	220	310	95	160	97,5	-	250	11	14	405	375	490	125	190	111
CAS-852-2T-7'5/10	833	945	603	470	94,5	380	310	M8	390	530	320	240	340	78	180	107,5	-	280	11	14	430	400	540	150	190	122
CAS-856-2T-15	833	945	708	575	93	355	395	M8	390	530	320	240	340	78	180	107,5	-	280	11	14	430	400	600	180	190	122
CAS-863-2T-15/20	873	995	728	585	103	355	410	M8	410	560	325	260	375	87,5	200	117,5	-	315	11	14	430	400	620	180	210	132
CAS-971-2T-25	1012	1170	759	598	116	400	450	M10	460	670	420	294	425	100	224	132	-	355	11	14	550	510	500	150	150	145
CAS-971-2T-30	1012	1170	881	720	116	400	450	M10	460	670	420	294	425	100	224	132	-	355	11	14	550	510	500	150	150	145
CAS-971-2T-40	1012	1170	948	787	116	400	450	M10	460	670	420	294	425	100	224	132	-	355	11	14	550	510	500	150	150	145

Dimensiones mm

CAS-1250...2080

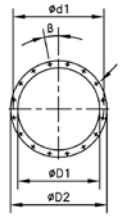

Boca de aspiración

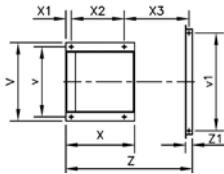
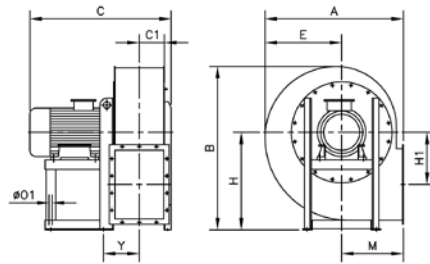

Boca de impulsión
CAS-1250-2T-15/A
CAS-1456-2T-25/A
CAS-1663-2T-50/A

Boca de impulsión
CAS-1671-2T-60/A
CAS-2071-2T-100/A
CAS-2080-2T-125/A

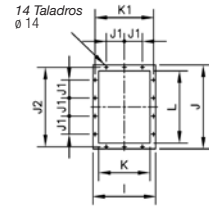
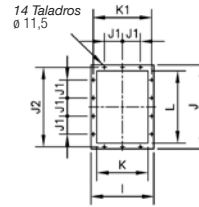

Modelo	A	B	C	C1	$\phi D1$	$\phi D2$	$\phi d1$	x ϕ	B	E	H	H1	I	J	J1	J2	K	K1	L	M	$\phi 01$	V	v	v1	X	X1	X2	X3	Y	Z	Z1
CAS-1250-2T-15/A	865	1055	885	160	361	441	405	8x11,5	22°30'	510	630	365	360	480	125	448	280	332	400	355	14	440	400	-	425	30	340	-	202	-	-
CAS-1456-2T-25/A	970	1185	900	163	456	535	497	12x12	15°	555	710	410	395	530	125	497	315	366	450	400	14	440	400	-	425	30	340	-	219	-	-
CAS-1663-2T-50/A	1010	1280	1035	183	568	668	629	16x11,5	11°15'	560	800	380	435	580	125	551	355	405	500	450	16	570	510	-	500	40	385	-	263	-	-
CAS-1671-2T-60/A	1130	1340	1160	206	638	738	698	16x13	11°15'	630	800	430	500	660	160	629	400	464	560	500	19	626	565	800	550	40	425	530	292	1025	60
CAS-2071-2T-100/A	1130	1340	1290	206	638	738	698	16x13	11°15'	630	800	430	500	660	160	629	400	464	560	500	21	760	680	800	700	50	550	545	307	1125	60
CAS-2080-2T-125/A	1270	1505	1345	231	718	818	775	16x13	11°15'	710	900	486	550	730	160	698	450	513	630	560	24	760	680	900	700	50	550	595	333	1225	60

CAS-680...1090

Boca de aspiración

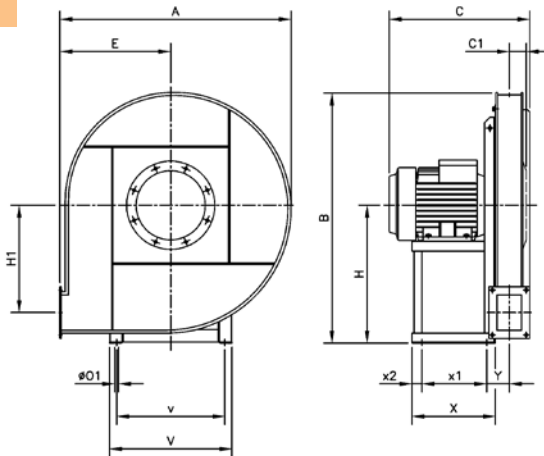
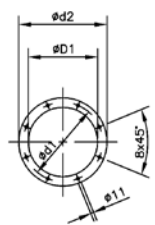

Boca de impulsión
CAS-680/790

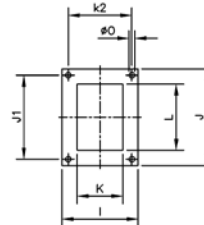

Boca de impulsión
CAS-980...1090

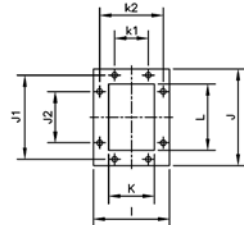

Modelo	A	B	C	C1	$\phi D1$	$\phi D2$	$\phi d1$	E	H	H1	I	J	J1	J2	K	k1	k2	L	$\phi 0$	$\phi 01$	V	v	X	x1	x2	Y
CAS-790-2T-20	1100	1180	650	58	185	219	255	530	630	520	140	172	140	-	80	-	112	112	9	14	440	400	425	340	30	103
CAS-980-2T-30	1120	1250	725	90	255	292	325	530	710	530	210	270	241	112	140	112	182	200	11,5	14	440	400	425	340	35	145
CAS-990-2T-50	1250	1400	900	100	286	332	366	600	800	600	230	294	265	112	160	112	200	224	11,5	16	570	510	500	385	40	165
CAS-1080-2T-40	1120	1250	850	90	255	392	325	530	710	530	210	270	241	112	140	112	182	200	11,5	16	570	510	500	385	40	155
CAS-1090-2T-60	1250	1400	930	100	286	332	366	600	800	600	230	294	265	112	160	112	200	224	11,5	16	626	565	550	425	40	175

CAS-S

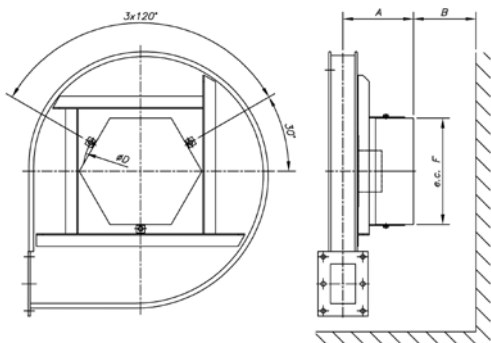

Modelo	A	B	ϕD	F	Modelo	A	B	ϕD	F
CAS-S-242	155	150	276	255	CAS-S-971	327	200	759	655
CAS-S-248	158	150	276	255	CAS-S-1250/A	371	200	683	655
CAS-S-254	162	150	276	255	CAS-S-1456/A	230	200	804	775
CAS-S-260	249	150	371	350	CAS-S-1663/A	234	200	804	775
CAS-S-463	247	150	371	350	CAS-S-680	251	200	371	350
CAS-S-467	249	150	371	350	CAS-S-790	259	200	371	350
CAS-S-571	251	150	371	350	CAS-S-980	290	200	581	560
CAS-S-640	267	150	371	350	CAS-S-990	300	200	581	560
CAS-S-645	275	200	581	560	CAS-S-1080	290	200	581	560
CAS-S-650	295	200	661	560	CAS-S-1090	300	200	581	560
CAS-S-852	305	200	661	560	CAS-S-1671/A	437	200	804	775
CAS-S-856	304	200	683	655	CAS-S-2071/A	437	200	804	775
CAS-S-863	314	200	758	655	CAS-S-2080/A	462	200	884	855

Curvas Características

Q= Caudal en m³/h, m³/s y cfm.

Pe= Presión estática en mmH₂O, Pa e inwg.

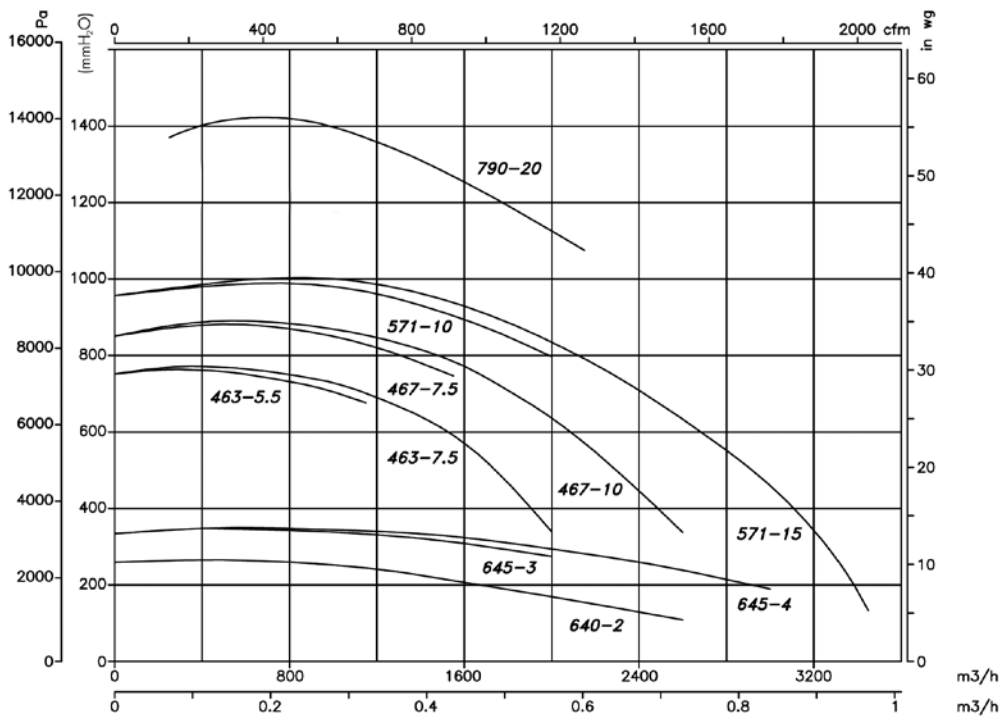
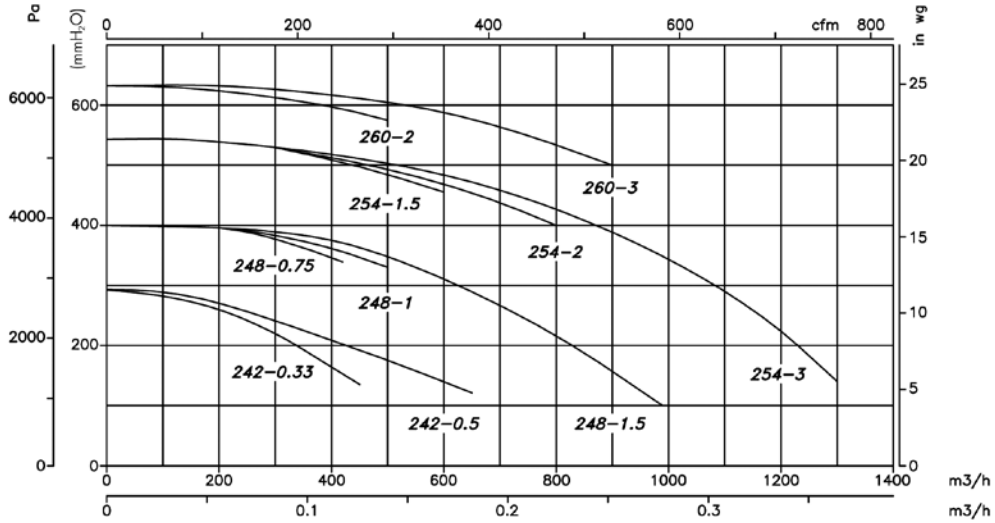

Curvas Características

Q= Caudal en m³/h, m³/s y cfm.

Pe= Presión estática en mmH₂O, Pa e inwg.

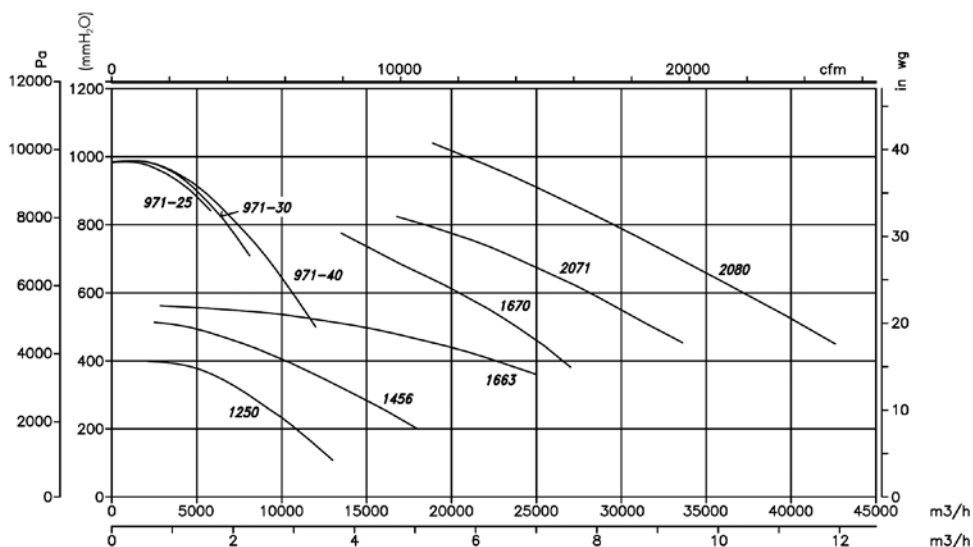
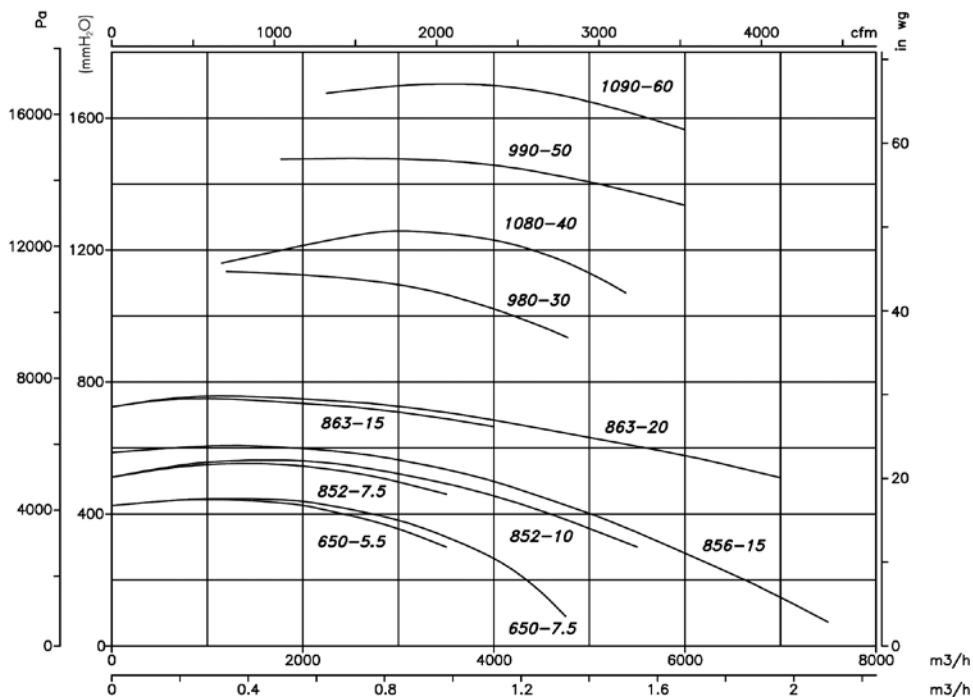

Orientaciones

Suministro standard LG 270
Posiciones LG 180 bajo demanda
y con medidas de anclaje especiales.



Suministro bajo demanda
Posiciones RD 180 con medidas
de anclaje especiales.



Accesorios

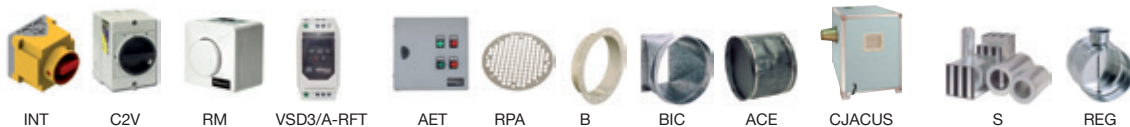

EXTRACTORES DE TEJADO

205

VC-HDU



Extractores centrifugos de tejado a transmisión con salida de aire vertical

208

CXT



Ventiladores centrifugos de cubierta, para impulsión de aire vertical u horizontal a transmisión

217

RFH



Extractores centrifugos de tejado 400°C/2h con salida de aire horizontal

222

RFV



Extractores centrifugos de tejado 400°C/2h con salida de aire vertical

222

CRF



Extractores centrifugos de tejado con bajo nivel sonoro

227

HT

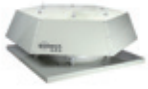

Extractores helicoidales de tejado con base plana

230

HTMH



Extractores de cubierta multifuncional para grandes caudales

233

HTMV



Extractores helicoidales de cubierta con salida de aire vertical

240



SISTEMAS DE EXTRACCIÓN CON VENTILADORES DE TEJADO

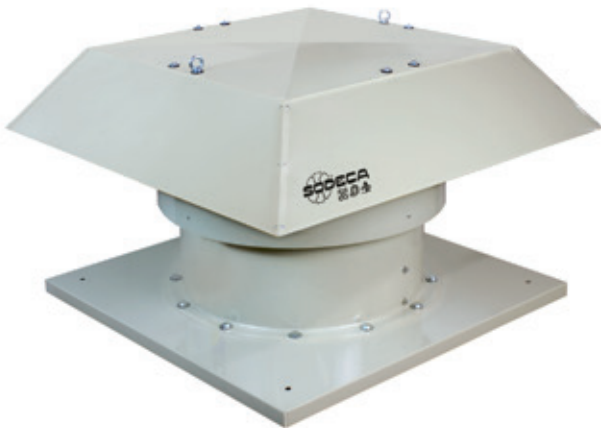

El ventilador de tejado o cubierta, permite contrarrestar los efectos perjudiciales que se crean cuando las altas temperaturas y la humedad alcanzan valores altos y desagradables para ejercer trabajos o esfuerzos físicos, además ayudan a prolongar la vida de los elementos estructurales de las naves y edificaciones al evitar la condensación y humedades. Un sistema adecuado de ventilación en naves industriales, reducirá considerablemente el gasto de refrigeración y calefacción, siendo éste un sistema adecuado para la eliminación del calor y la humedad de forma fácil, continuada y eficaz.

Los extractores y ventiladores de tejado de Sodeca se adaptan a cualquier tipo de tejado y sus diferentes modelos permiten la solución idónea a cada instalación, optimizando así su funcionamiento.



EFFICIENT WORK



AHORRO DE ENERGÍA

Con el concepto de ventiladores creados por Sodeca, EFFICIENT WORK que incorporan motores de nueva generación IE4 E.C. de alto rendimiento, la energía consumida a diario se reduce alrededor del 45%. Además, se pueden controlar con sistemas de ventilación inteligentes, que se encargan de saber la necesidad de ventilación adecuada en cada momento para disminuir al máximo el consumo de energía.



SEGURIDAD EN CASO DE INCENDIOS

Las normativas de seguridad contra incendios, obligan a aplicar sistemas de control de temperatura y evacuación de humos de acuerdo a la norma UNE / EN-23585, requisitos y métodos de cálculo y diseño para proyectar un sistema de control de temperatura y de evacuación de humos en caso de incendio. Para dar solución a las necesidades de esta norma, existen los ventiladores de tejado homologados para este fin, de acuerdo a la norma EN-12101-3 con certificados F-400 (400°C/2h) o F-300 (300°C/2h).



CONFORT Y REDUCCIÓN DE RUIDOS

Un ambiente de trabajo con las condiciones de confort adecuadas es plenamente necesario y permite un desempeño laboral de alta eficiencia. La instalación de ventiladores en el exterior, nos permite un mayor confort en zonas de trabajo, reduciendo el ruido y evitando espacio ocupado dentro de las naves industriales.



REDUCCIÓN DE CALOR Y HUMEDAD

El aire caliente generado por la actividad interior y el calentamiento de la cubierta por la radiación solar, convierte el techo de las naves industriales, en grandes radiadores de calor, traspasando éste a las zonas de trabajo, subiendo la temperatura y la factura de electricidad debido a más necesidad de refrigeración. También en climas más fríos, las condensaciones aumentan el nivel de humedad, saturando el material aislante de las cubiertas y reduciendo la efectividad de estas. Un buen sistema de ventilación, ayuda a evitar todos estos efectos perjudiciales para la estructura del edificio y para la salud de las personas.



MANTENIMIENTO Y LIMPIEZA

Es muy importante la facilidad de limpieza de los ventiladores de cubierta, por su difícil accesibilidad. El mantenimiento de todos los elementos del sistema de extracción es muy importante para conseguir un nivel alto de limpieza y obtener un grado de higiene necesario en cada instalación, evitando así la posibilidad del manejo de partículas de aire contaminadas. La facilidad de mantenimiento y instalación de los equipos de tejado, supone una importante reducción de costes a tener en cuenta.



VC-HDU

Extractores centrífugos de tejado a transmisión con salida de aire vertical en aluminio

Extractores centrífugos de tejado a transmisión con salida de aire vertical en aluminio para extracción en campanas y cocinas Industriales y ambientes nocivos.

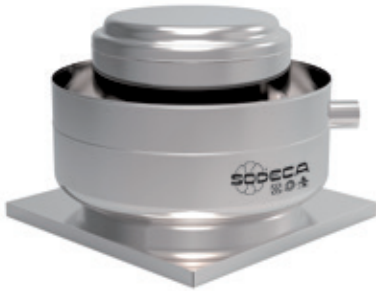

Ventilador:

- Base soporte en chapa de acero galvanizado
- Turbina con álabes a reacción, en aluminio
- Envoltorio cilíndrico y cubierta en aluminio
- Cubierta superior de fácil apertura para inspección y mantenimiento
- Grupo de transmisión soportado con amortiguadores para evitar vibraciones y ruidos.

- Motores clase F, con rodamientos a bolas, protección IP55
- Motor Multitensión, diseño especial válido para: 220/380V 60Hz, 254/440V 60Hz, 265/460V 60Hz, 277/480V 60Hz
- Temperatura máxima del aire a transportar: -20°C +120°C

Acabado:

- Anticorrosivo en chapa de aluminio satinado y partes en acero galvanizado

Motor:

- Motores de eficiencia IE3 para potencias iguales o superiores a 0,75kW, excepto monofásicos, 2 velocidades y 8 polos.

Código de pedido

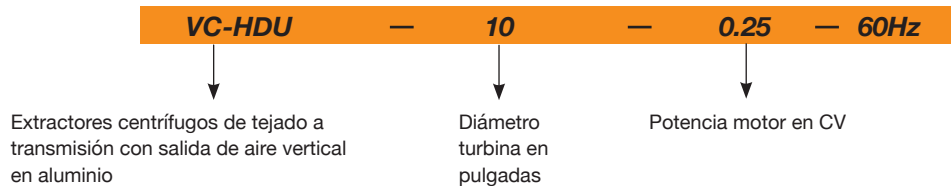

Características técnicas

60Hz

Modelo	Velocidad (r/min)	Intensidad máxima admisible (A)		Potencia instalada (kW)	Caudal máximo (m³/h)	Nivel presión sonora* dB(A)	Peso Aprox. (Kg)
		220-277V	380-480V				
VC-HDU-10-0.25	1580	1,23	0,71	0,18	2690	36	28
VC-HDU-10-0.33	1760	1,52	0,88	0,25	3000	39	28
VC-HDU-12-0.25	1200	1,23	0,71	0,18	2850	38	33
VC-HDU-12-0.33	1340	1,52	0,88	0,25	3180	40	33
VC-HDU-12-0.5	1530	2,02	1,17	0,37	3630	43	34
VC-HDU-15-0.25	840	1,23	0,71	0,18	3580	36	34
VC-HDU-15-0.33	935	1,52	0,88	0,25	3990	38	34
VC-HDU-15-0.5	1065	2,02	1,17	0,37	4550	41	35
VC-HDU-15-0.75	1220	2,87	1,66	0,55	5190	44	37
VC-HDU-15-1	1350	2,82	1,62	0,75	5750	46	42
VC-HDU-18-0.25	665	1,23	0,71	0,18	4470	31	42
VC-HDU-18-0.33	740	1,52	0,88	0,25	4980	33	42
VC-HDU-18-0.5	845	2,02	1,17	0,37	5680	36	43
VC-HDU-18-0.75	965	2,87	1,66	0,55	6490	39	45
VC-HDU-18-1	1070	2,82	1,62	0,75	7190	41	50
VC-HDU-18-1.5	1215	4,07	2,34	1,1	8170	44	55

Características técnicas

Modelo	Velocidad (r/min)	Intensidad máxima admisible (A)		Potencia instalada (kW)	Caudal máximo (m³/h)	Nivel presión sonora* dB(A)	Peso Aprox. (Kg)
		220-277V	380-480V				
VC-HDU-18-2	1350	5,48	3,15	1,5	9080	46	58
VC-HDU-20-0.33	640	1,52	0,88	0,25	5900	33	44
VC-HDU-20-0.5	735	2,02	1,17	0,37	6730	36	45
VC-HDU-20-0.75	835	2,87	1,66	0,55	7670	39	47
VC-HDU-20-1	925	2,82	1,62	0,75	8510	41	52
VC-HDU-20-1.5	1050	4,07	2,34	1,1	9670	44	57
VC-HDU-20-2	1170	5,48	3,15	1,5	10740	46	60
VC-HDU-22-0.33	510	1,52	0,88	0,25	6950	32	83
VC-HDU-22-0.5	580	2,02	1,17	0,37	7920	35	84
VC-HDU-22-0.75	660	2,87	1,66	0,55	9020	38	86
VC-HDU-22-1	735	2,82	1,62	0,75	10030	40	91
VC-HDU-22-1.5	835	4,07	2,34	1,1	11400	43	96
VC-HDU-22-2	930	5,48	3,15	1,5	12660	45	99
VC-HDU-24-0.33	495	1,52	0,88	0,25	8510	34	86
VC-HDU-24-0.5	565	2,02	1,17	0,37	9700	37	87
VC-HDU-24-0.75	645	2,87	1,66	0,55	11070	40	89
VC-HDU-24-1	715	2,82	1,62	0,75	12270	42	94
VC-HDU-24-1.5	810	4,07	2,34	1,1	13950	45	99
VC-HDU-24-2	900	5,48	3,15	1,5	15490	47	102

*Nivel de presión sonora medida a 6 metros y a caudal medio (1/2 Qmax.)

Dimensiones mm

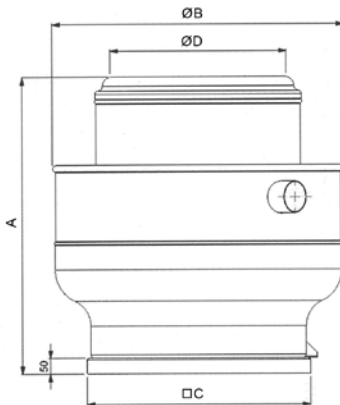

Modelo	A	ØB	C	ØD
VC-HDU-10	640	660	530	400
VC-HDU-12	750	750	610	450
VC-HDU-15	750	750	610	450
VC-HDU-18	944	928	710	560
VC-HDU-20	944	928	710	560
VC-HDU-22	1050	1190	920	720
VC-HDU-24	1050	1190	920	720

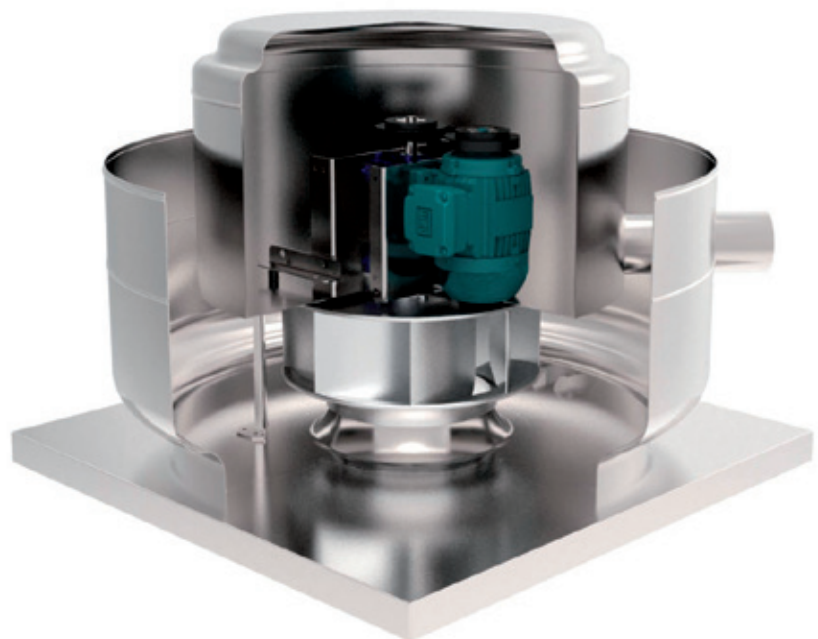

Curvas características

Q= Caudal en m³/h, m³/s y cfm

Pe= Presión estática en mmH₂O, Pa e inwg

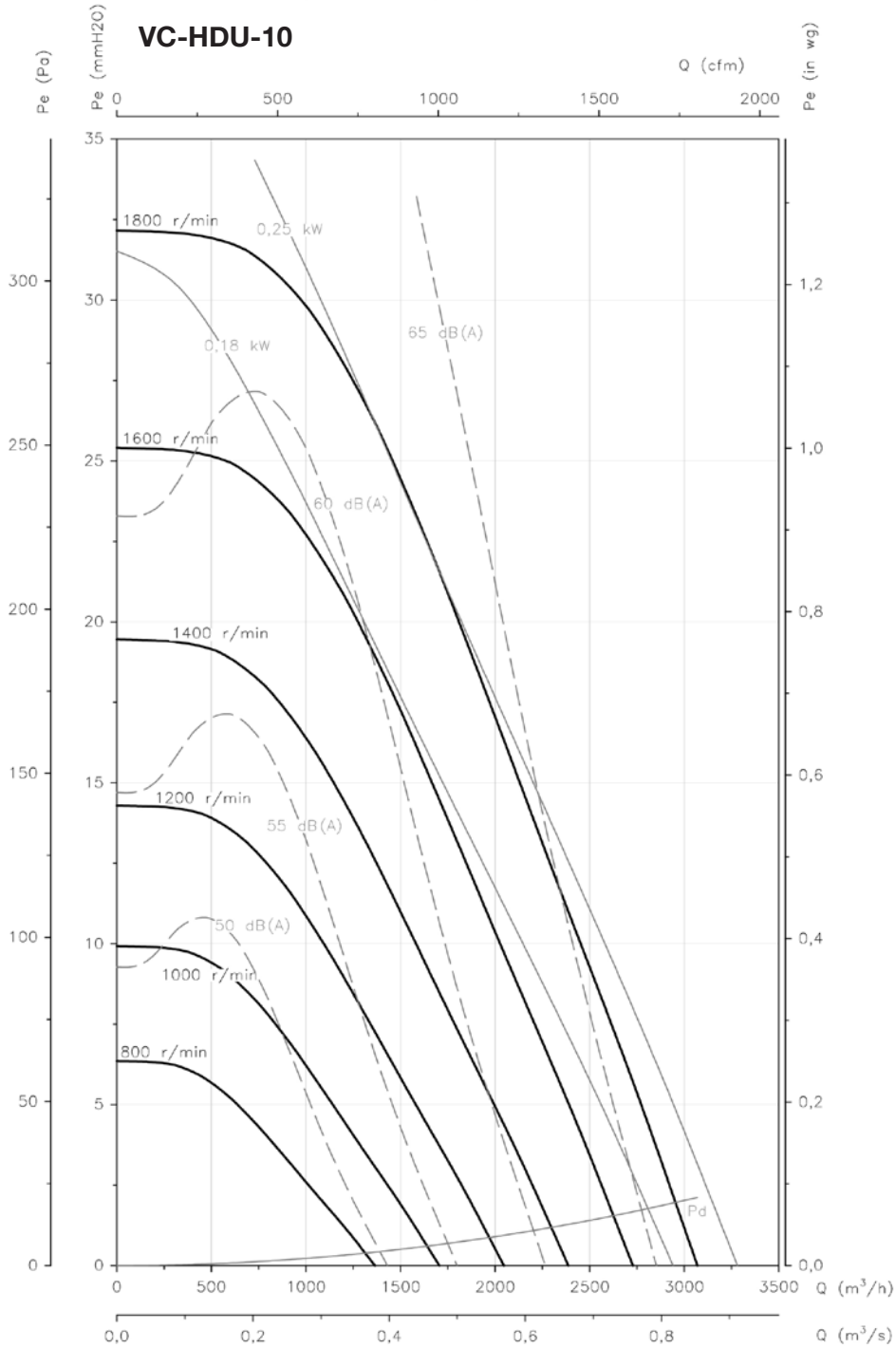

Curvas características

Q= Caudal en m³/h, m³/s y cfm

Pe= Presión estática en mmH₂O, Pa e inwg

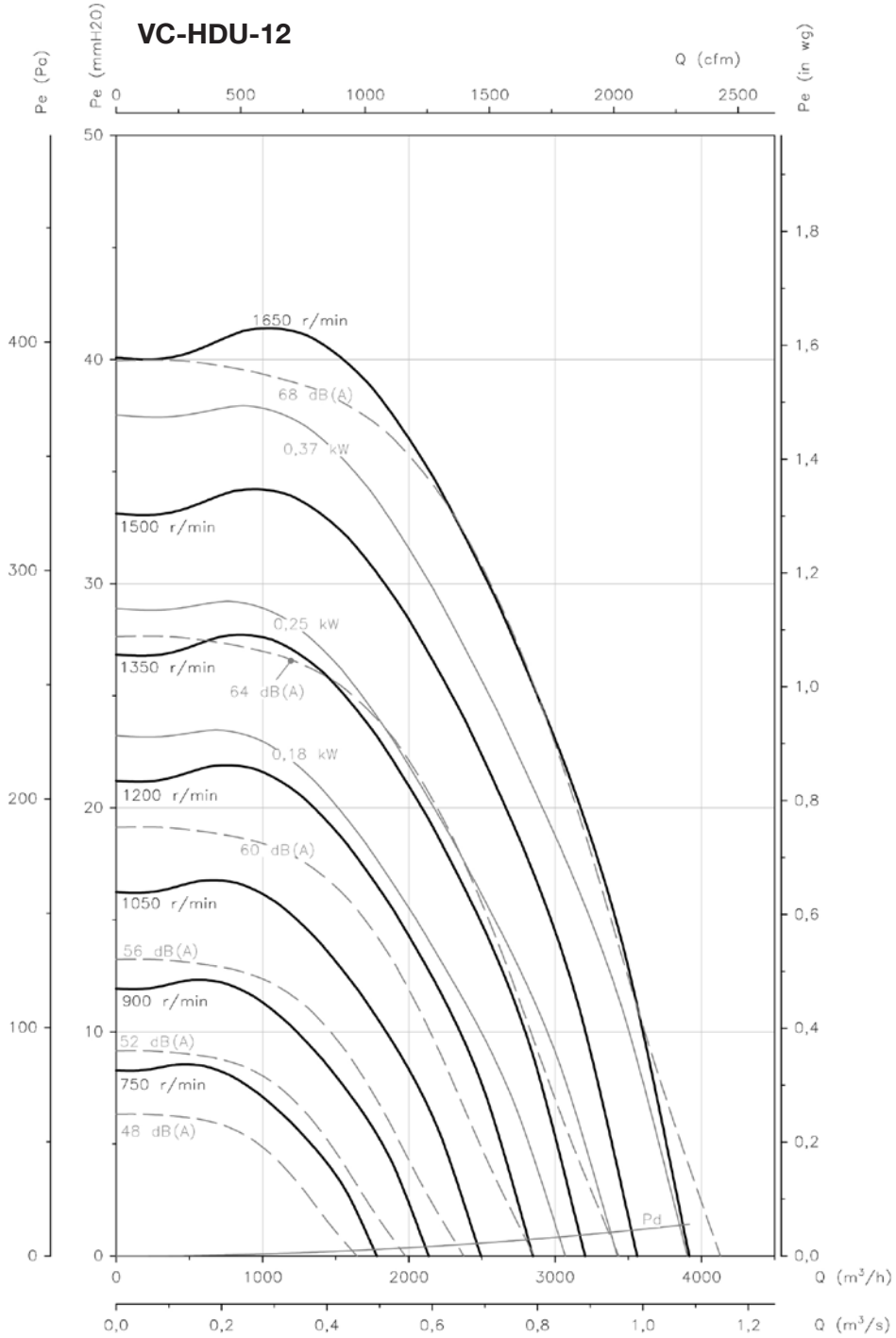

Curvas características

Q= Caudal en m³/h, m³/s y cfm

Pe= Presión estática en mmH₂O, Pa e inwg

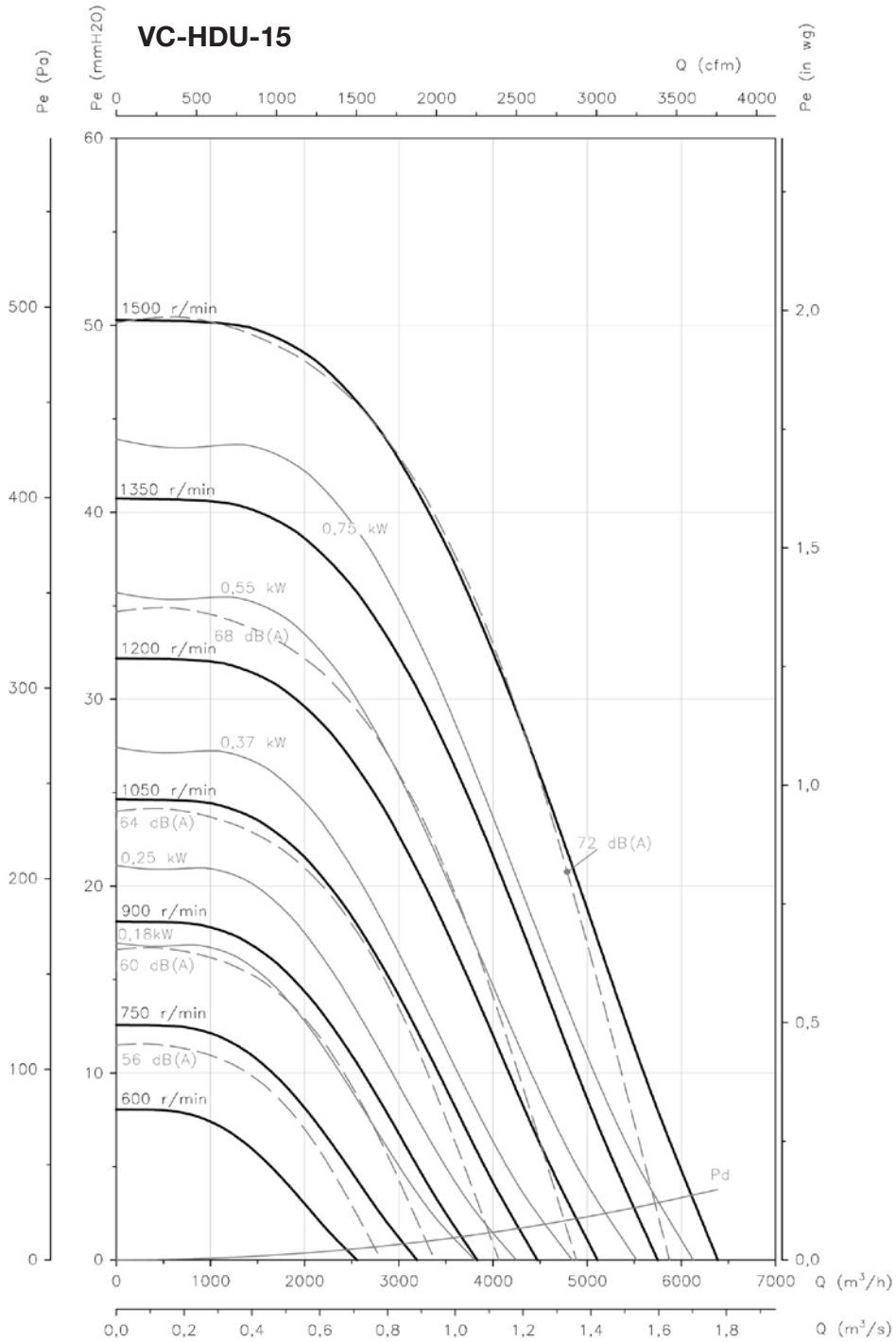

Curvas características

Q= Caudal en m³/h, m³/s y cfm

Pe= Presión estática en mmH₂O, Pa e inwg

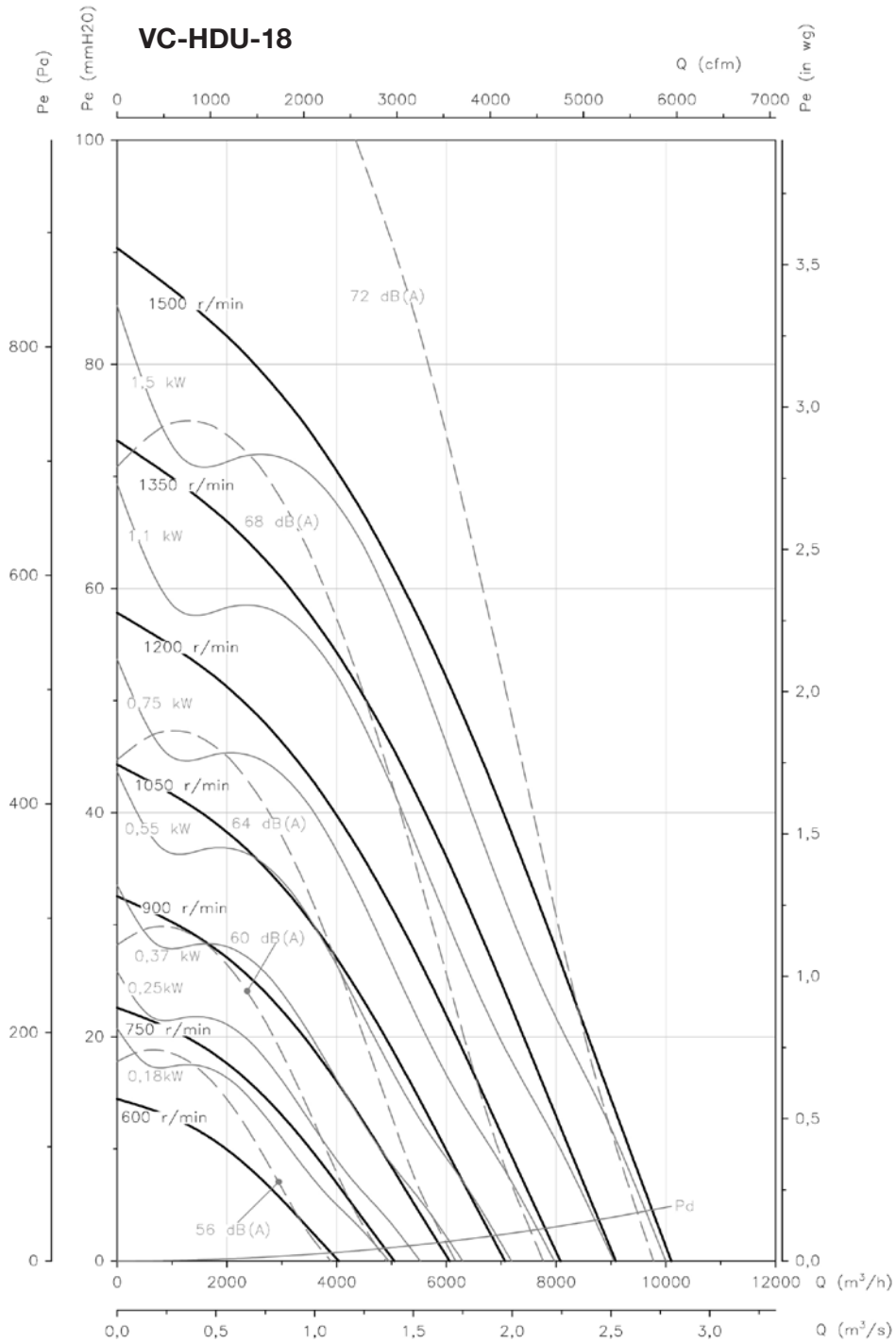

Curvas características

Q= Caudal en m³/h, m³/s y cfm

Pe= Presión estática en mmH₂O, Pa e inwg

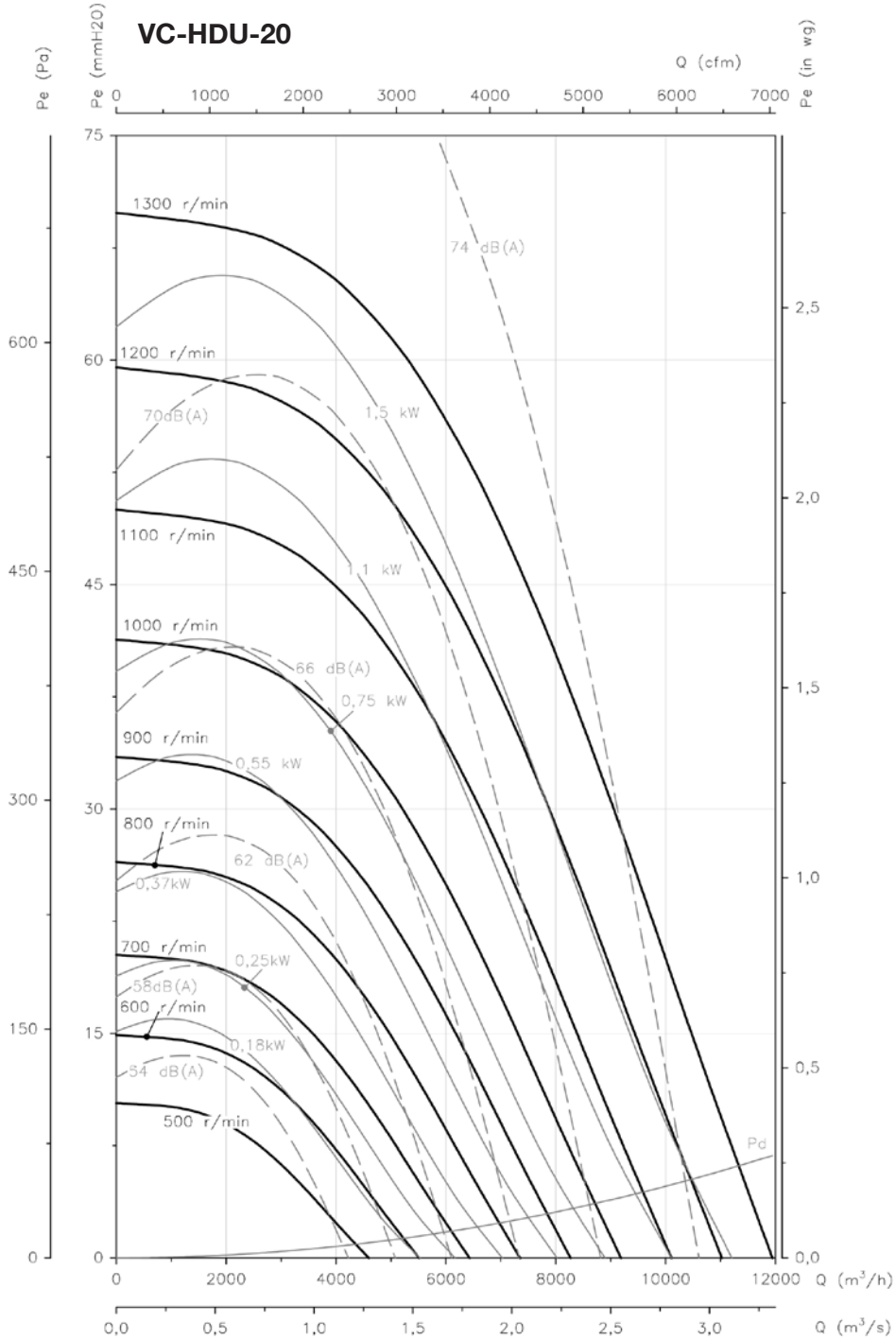

Curvas características

Q= Caudal en m³/h, m³/s y cfm

Pe= Presión estática en mmH₂O, Pa e inwg

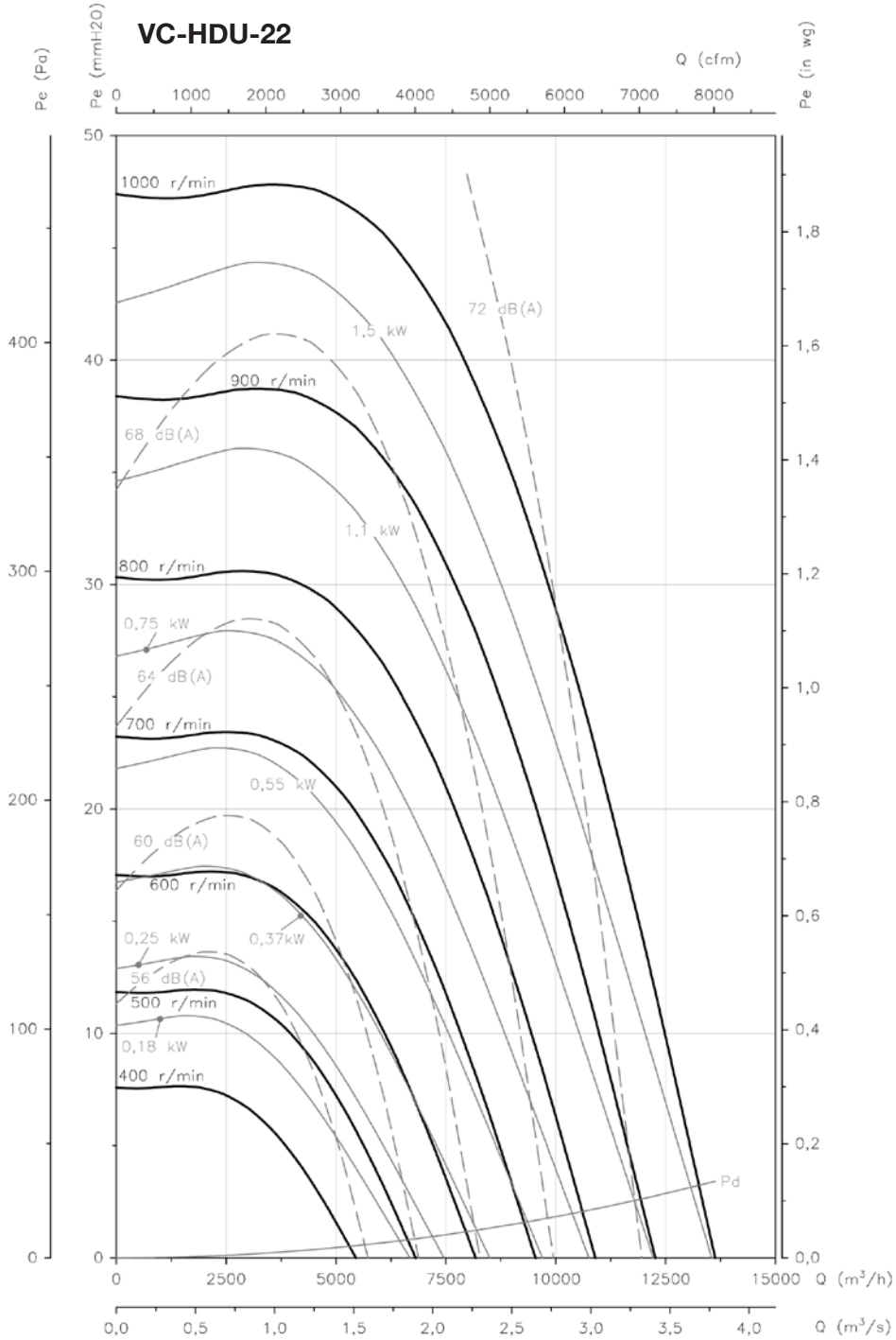

Curvas características

Q= Caudal en m³/h, m³/s y cfm

Pe= Presión estática en mmH₂O, Pa e inwg

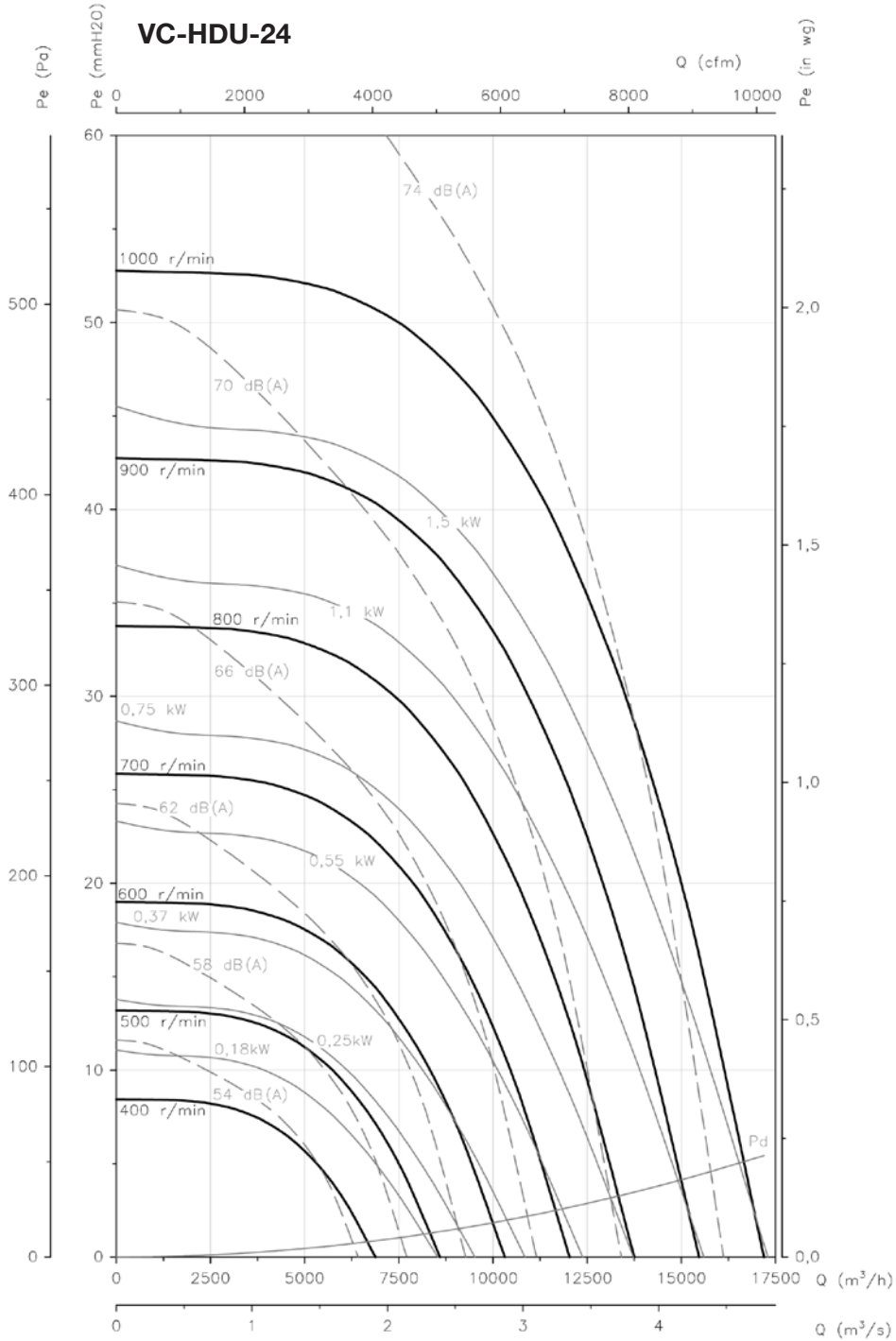

CXT

Ventiladores centrífugos de cubierta, para impulsión de aire vertical u horizontal a transmisión.

Ventiladores centrífugos de cubierta, con impulso de aire vertical u horizontal, de doble impulsión a transmisión, con filtros lavables.



Suministro standard
impulsión vertical

Ventilador:

- Base soporte en chapa de acero galvanizado.
- Sombrero y deflectores de aluminio.
- Estructura en perfilera de aluminio y tapas laterales en chapa de acero prelacado.
- Accionado mediante transmisión por correas y poleas.
- Salida de aire orientable vertical u horizontal, adaptable por el cliente según necesidad de la instalación.
- Prensaestopas para la entrada de cable.
- Turbina con álabes hacia delante, en chapa de acero galvanizado.
- Filtros de entrada de aire metálicos fácilmente lavables.

Motor:

- Motores eficiencia IE3 para potencias iguales o superiores a 0,75 kW, excepto monofásicos, 2 velocidades y 8 polos.
- Motores clase F, con rodamientos a bolas, protección IP55.
- Trifásicos 220-254V / 380-440V, 60Hz.
- Temperatura máxima de aire a transportar: -20°C. +60°C.

Acabado:

- Anticorrosivo en chapa de acero prelacada y aluminio

Bajo demanda:

- Con impulsión horizontal



Boca de impulsión
horizontal



Código de pedido

CXT	—	9/9	—	3	—	V	—	60Hz
↓		↓		↓		↓		
CXT: Ventiladores centrífugos de cubierta con salida de aire vertical u horizontal		Tamaño de la turbina en pulgadas		Potencia motor en CV		V: Impulsión vertical H: Impulsión horizontal		

Características técnicas

60Hz

Modelo	Velocidad (r/min)	Intensidad máxima admisible (A)		Potencia instalada (kW)	Caudal máximo (m³/h)	Nivel presión sonora* dB(A)	Peso Aprox. (Kg)
		220-254V	380-440V				
CXT-9/9-0.25	650	1,23	0,71	0,18	2635	45	111
CXT-9/9-0.33	725	1,52	0,88	0,25	2940	48	111
CXT-9/9-0.5	825	2,02	1,17	0,37	3350	50	112
CXT-9/9-0.75	940	2,87	1,66	0,55	3820	53	114
CXT-9/9-1 IE3	1045	2,82	1,62	0,75	4240	56	119
CXT-9/9-1.5 IE3	1185	4,07	2,34	1,10	4815	58	124
CXT-10/10-0.5	650	2,02	1,17	0,37	4065	50	121
CXT-10/10-0.75	740	2,87	1,66	0,55	4640	53	123
CXT-10/10-1 IE3	820	2,82	1,62	0,75	5145	55	128
CXT-10/10-1.5 IE3	930	4,07	2,34	1,10	5845	58	133
CXT-10/10-2 IE3	1035	5,48	3,15	1,50	6495	60	136
CXT-12/12-0.5	535	2,02	1,17	0,37	4885	40	140
CXT-12/12-0.75	610	2,87	1,66	0,55	5580	43	141
CXT-12/12-1 IE3	680	2,82	1,62	0,75	6185	45	146
CXT-12/12-1.5 IE3	770	4,07	2,34	1,10	7030	48	151
CXT-12/12-2 IE3	855	5,48	3,15	1,50	7805	50	155

Características técnicas

Modelo	Velocidad (r/min)	Intensidad máxima admisible (A)		Potencia instalada (kW)	Caudal máximo (m ³ /h)	Nivel presión sonora* dB(A)	Peso Aprox. (Kg)
		220-254V	380-440V				
CXT-12/12-3 IE3	975	7,93	4,56	2,20	8890	53	163
CXT-15/15-0.75	450	2,87	1,66	0,55	7195	44	159
CXT-15/15-1 IE3	495	2,82	1,62	0,75	7910	46	164
CXT-15/15-1.5 IE3	570	4,07	2,34	1,10	9075	49	169
CXT-15/15-2 IE3	630	5,48	3,15	1,50	10075	51	173
CXT-15/15-3 IE3	720	7,93	4,56	2,20	11515	54	181
CXT-18/18-1.5 IE3	455	4,07	2,34	1,10	11390	50	246
CXT-18/18-2 IE3	505	5,48	3,15	1,50	12650	52	249
CXT-18/18-3 IE3	575	7,93	4,56	2,20	14410	55	258
CXT-18/18-4 IE3	640	10,70	6,15	3,00	16020	58	264
CXT-18/18-5.5 IE3	705	13,90	8,00	4,00	17695	60	270

*Nivel de presión sonora medida a 6 metros y a caudal medio (1/2 Qmax.)

Dimensiones mm

Suministro standard impulsión vertical

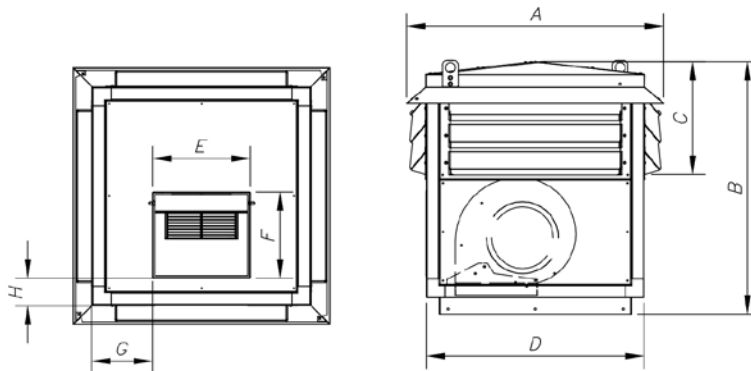

Bajo demanda impulsión horizontal

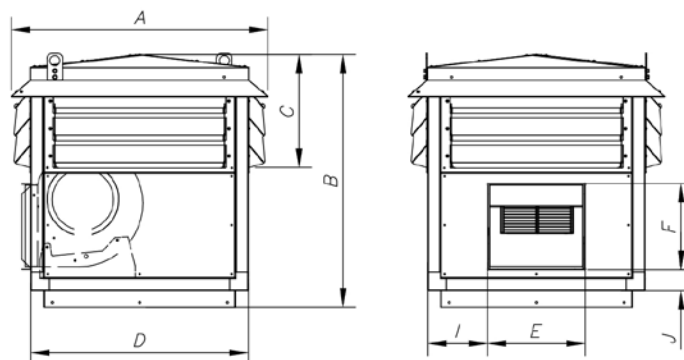

Model	A	B	C	D	E	F	G	H	I	J
CXT-9/9	824	811	362	700	314	277	196	88	192	67
CXT-10/10	925	855	362	802	314	305	230	125	226	67
CXT-12/12	1027	995	451	903	348	358	250	136	245	67
CXT-15/15	1027	1060	451	902	411	420	211	74	207	67
CXT-18/18	1129	1400	718	1005	487	496	220	46	216	67

Curvas características

Caudal en m³/h. Presión estática en Pa. Potencia eléctrica en W. Potencia sonora en dBA.

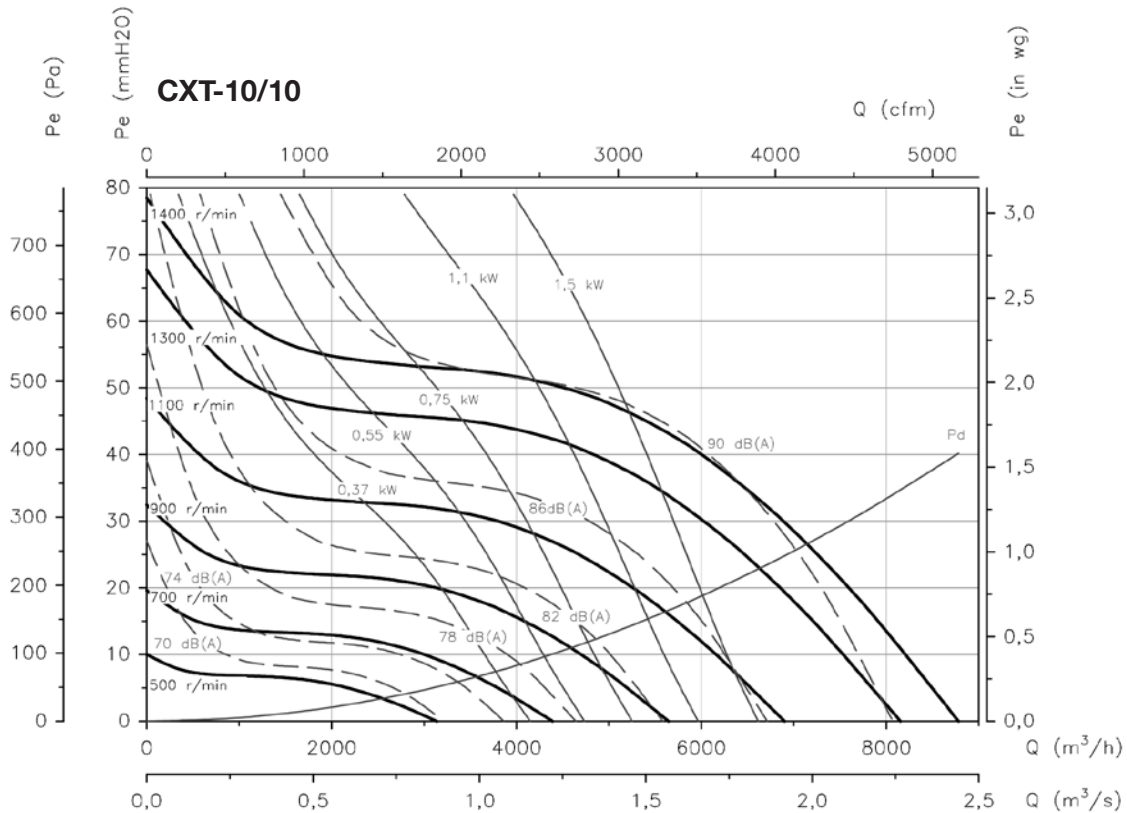
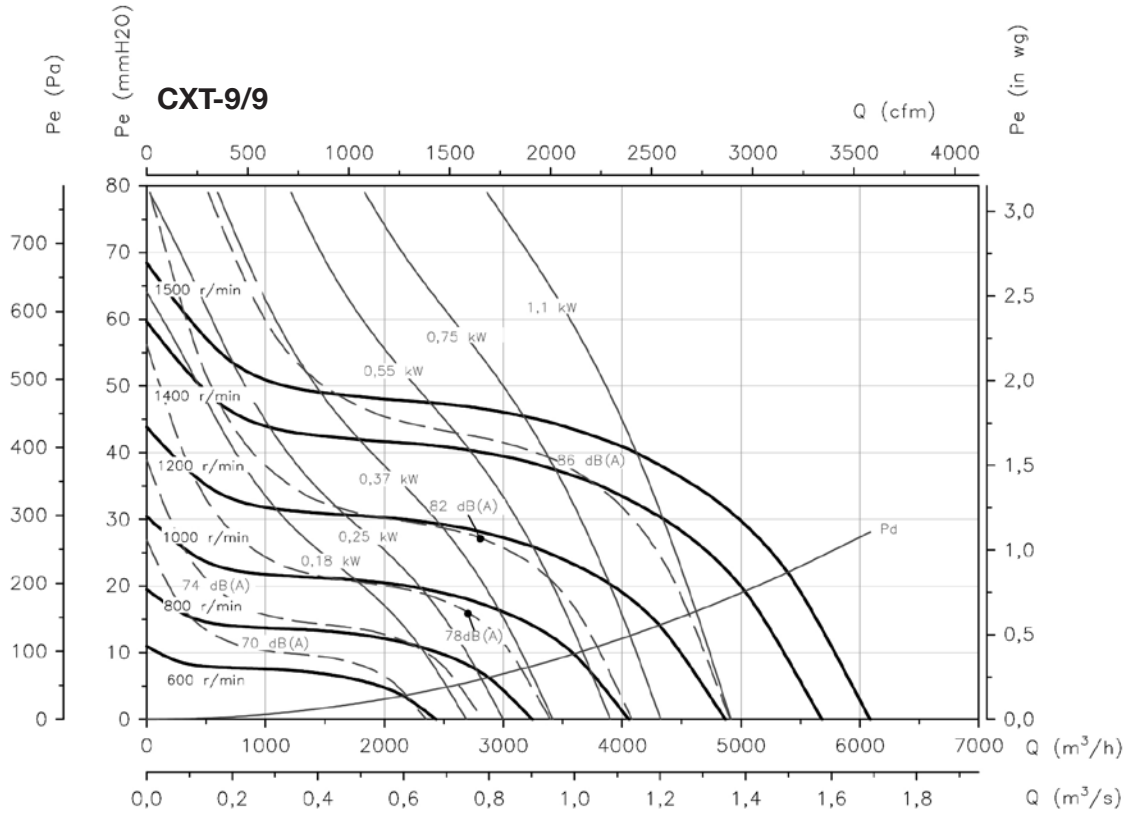

Curvas características

Caudal en m³/h. Presión estática en Pa. Potencia eléctrica en W. Potencia sonora en dBA.

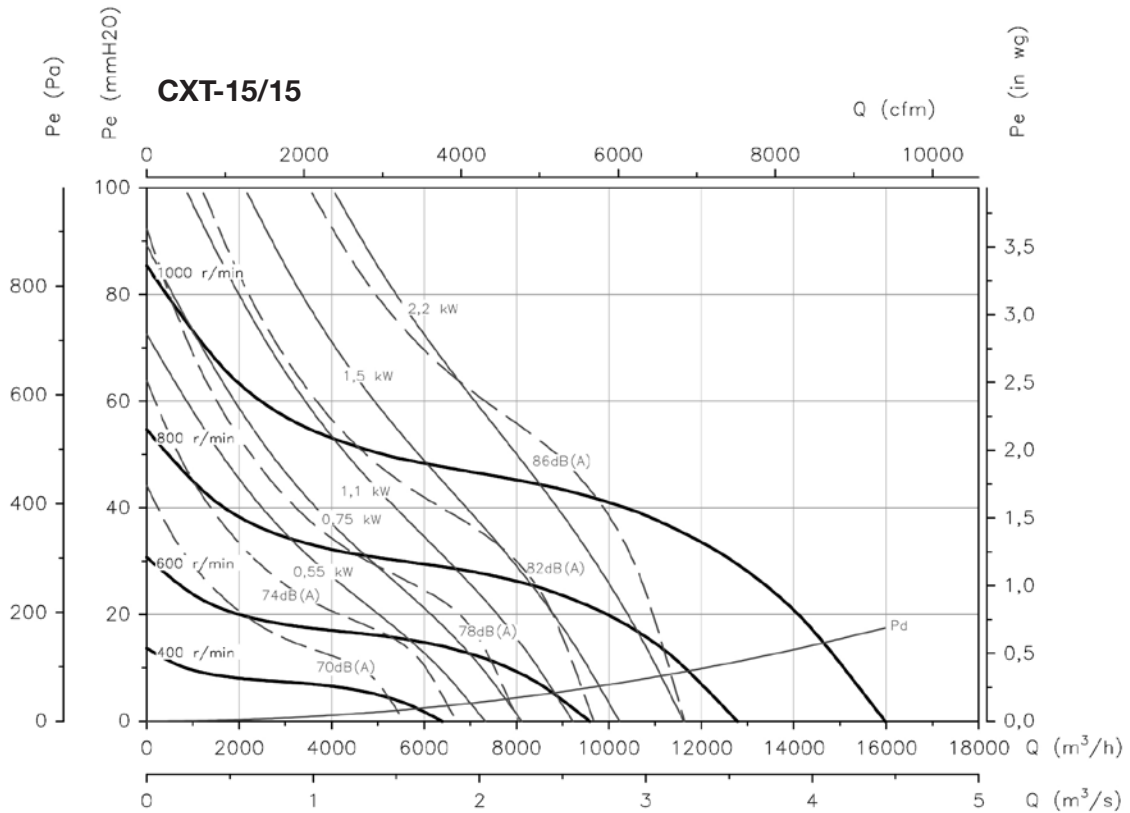
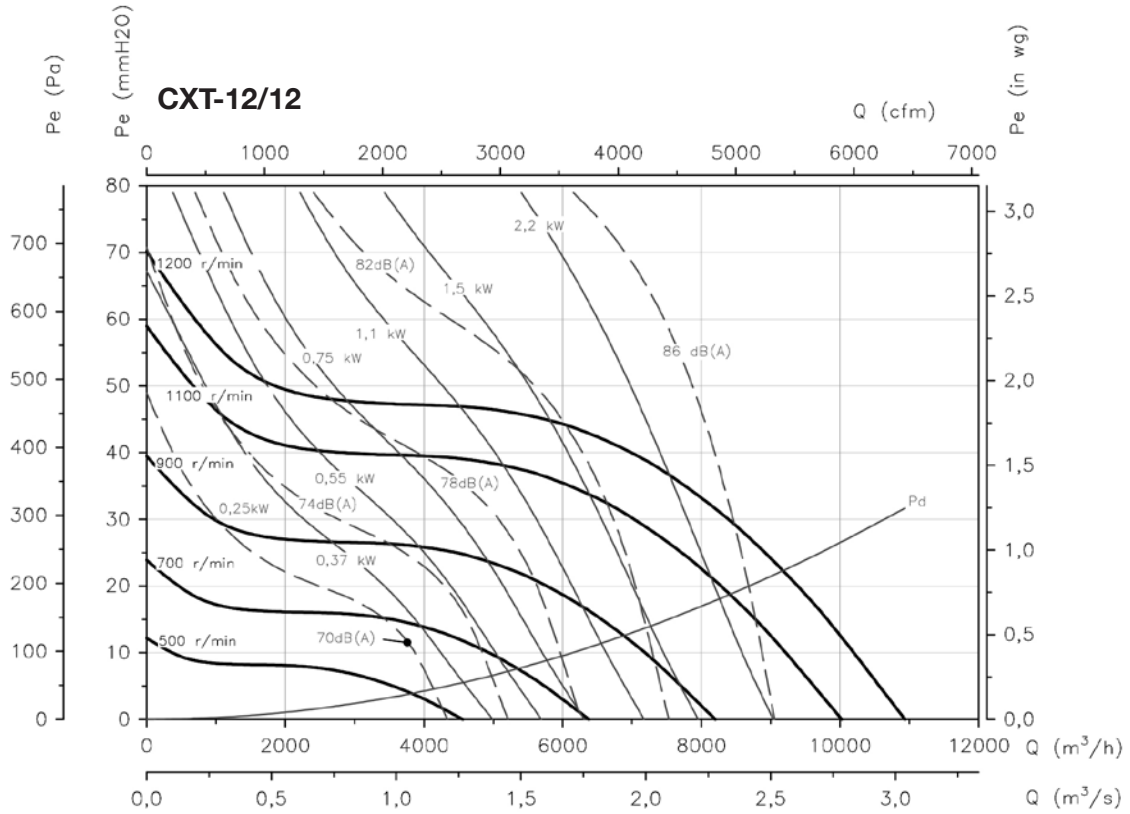

Curvas características

Caudal en m³/h. Presión estática en Pa. Potencia eléctrica en W. Potencia sonora en dBA.

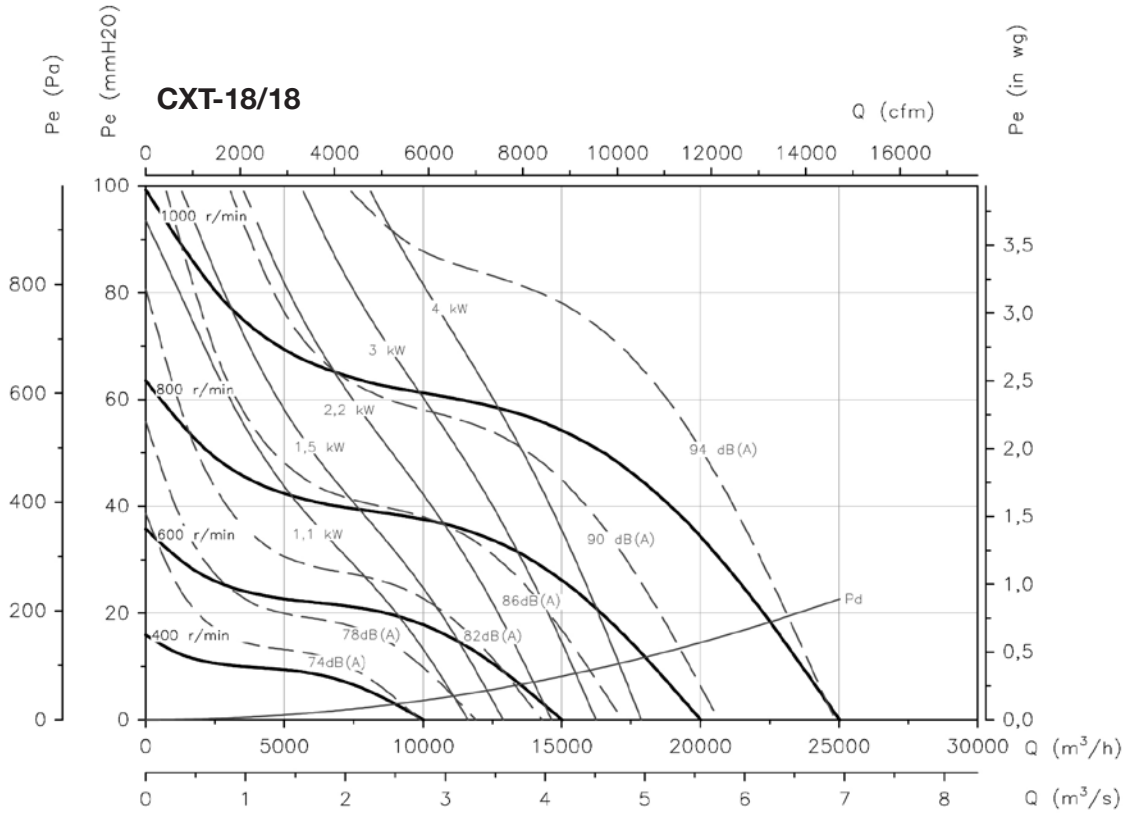

Accesorios



INT

C2V

RM

VSD

AET

VIS

RFH RFV



Extractores centrífugos de tejado 400°C/2h, con salida de aire horizontal o vertical

RFH: Extractores centrífugos de tejado 400°C/2h, con salida de aire horizontal, sombrero en aluminio

RFV: Extractores centrífugos de tejado 400°C/2h, con salida de aire vertical, sombrero en aluminio



Ventilador:

- Base soporte en chapa de acero galvanizado
- Turbina con álabes a reacción, en chapa de acero galvanizado
- Rejilla de protección antipájaros
- Sombrero deflector antilluvia en aluminio
- Homologación según norma EN 12101-3:2002/AC:2006

- Motor Multitensión, diseño especial válido para: 220/380V 60Hz, 254/440V 60Hz, 265/460V 60Hz, 277/480V 60Hz
- Temperatura máxima del aire a transportar: -25°C.+ 120°C.

Acabado:

- Anticorrosivo en chapa de acero galvanizado y en aluminio

Motor:

- Motores de eficiencia IE3 para potencias iguales o superiores a 0,75kW, excepto monofásicos, 2 velocidades y 8 polos.
- Motores clase F, con rodamientos a bolas, protección IP55

Bajo demanda:

- Bobinados especiales para diferentes tensiones.
- Certificación ATEX Categoría 3.

Código de pedido

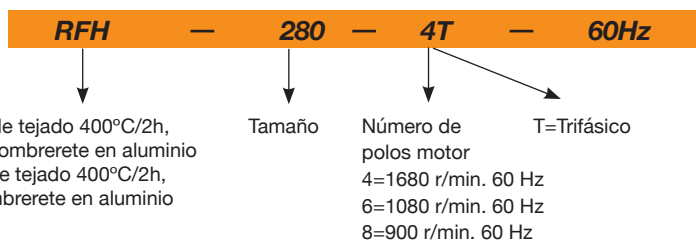

Características técnicas

60Hz

Modelo	Velocidad (r/min)	Intensidad máxima (A)		Potencia instalada (kW)	Caudal máximo (m³/h)	Nivel presión sonora* dB(A)		Peso Aprox. (Kg)
		220-277V	380-480V			Aspiración	Descarga	
RFH RFV 280-4T	1620	1,66	0,96	0,25	1450	38,85	45,15	25
RFH RFV 280-4M	1656	0,65		0,25	1450	38,85	45,15	25
RFH RFV 315-4T	1620	1,66	0,96	0,25	2100	43,05	49,35	25
RFH RFV 315-4M	1656	0,95		0,25	2100	43,05	49,35	25
RFH RFV 315-6T	1080	1,51	0,87	0,25	1400	31,50	37,80	25
RFH RFV 315-6M	1068	0,50		0,25	1400	31,50	37,80	25
RFH RFV 355-4T	1620	1,66	0,96	0,25	3100	47,25	52,50	32
RFH RFV 355-4M	1656	1,35		0,25	3100	47,25	52,50	32
RFH RFV 355-6T	1080	1,51	0,87	0,25	2000	34,65	42,00	33
RFH RFV 355-6M	1068	0,65		0,25	2000	34,65	42,00	33
RFH RFV 400-4T	1656	2,92	1,69	0,55	4950	50,40	56,70	35
RFH RFV 400-4M	1656	3,30		0,55	4950	50,40	56,70	35

Características técnicas

Modelo	Velocidad (r/min)	Intensidad máxima (A)		Potencia instalada (kW)	Caudal máximo (m³/h)	Nivel presión sonora* dB(A)		Peso Aprox. (Kg)
		220-277V	380-480V			Aspiración	Descarga	
RFH RFV 400-6T	1080	2,24	1,30	0,37	3200	38,85	45,15	35
RFH RFV 400-6M	1092	0,95		0,37	3200	38,85	45,15	35
RFH RFV 450-4T	1692	3,10	1,79	0,75	7000	57,75	64,05	52
RFH RFV 450-4M	1656	4,40		0,75	7000	57,75	64,05	52
RFH RFV 450-6T	1080	2,24	1,30	0,37	4500	46,20	52,50	51
RFH RFV 450-6M	1092	1,80		0,37	4500	46,20	52,50	51
RFH RFV 500-4T	1716	5,96	3,44	1,50	10200	61,95	67,20	60
RFH RFV 500-6T	1080	2,24	1,30	0,37	6900	49,35	56,70	53
RFH RFV 500-6M	1092	2,00		0,37	6900	49,35	56,70	53
RFH RFV 630-6T	1134	4,88	2,82	1,10	12000	53,55	59,85	95
RFH RFV 630-8T	834	3,53	2,04	0,55	8900	46,20	52,50	95
RFH RFV 710-6T	1146	9,30	5,30	2,20	17300	56,70	64,05	118
RFH RFV 710-8T	846	5,63	3,25	1,10	12900	48,30	55,65	102
RFH RFV 800-6T	1152	16,50	9,46	4,00	24700	60,90	67,20	160
RFH RFV 800-8T	846	7,10	4,10	1,50	18400	52,50	59,85	142

Características acústicas

Los valores indicados, se determinan mediante medidas de nivel de presión y potencia sonora en dB(A) obtenidas en campo libre a una distancia de 6 mts.

Espectro de potencia sonora Lw(A) en dB(A) por banda de frecuencia en Hz.

Valores tomados a la aspiración con 2/3 caudal máximo (2/3Qmax).

Modelo	63	125	250	500	1000	2000	4000	8000
280-4	35	41	52	55	56	52	50	44
315-4	42	51	56	56	60	59	52	46
315-6	31	40	45	45	49	48	41	35
355-4	46	55	60	60	64	63	56	50
355-6	34	43	48	48	52	51	44	38
400-4	50	56	62	62	65	68	59	53
400-6	39	45	51	51	54	57	48	42
450-4	57	63	69	69	72	75	66	60
450-6	46	52	58	58	61	64	55	49
500-4	62	69	74	74	78	77	70	65
500-6	50	57	62	62	66	65	58	53
630-6	54	60	65	66	70	69	62	55
630-8	47	53	58	59	63	62	55	48
710-6	57	63	68	69	73	72	65	58
710-8	49	55	60	61	65	64	57	50
800-6	61	67	72	73	77	76	69	62
800-8	53	59	64	65	69	68	61	54

Valores tomados a la descarga con 2/3 caudal máximo (2/3Qmax).

Modelo	63	125	250	500	1000	2000	4000	8000
280-4	39	44	58	60	61	61	56	51
315-4	41	50	60	64	67	64	57	51
315-6	30	39	49	53	56	53	46	40
355-4	44	53	63	67	70	67	60	54
355-6	34	43	53	57	60	57	50	44
400-4	49	61	69	71	72	72	64	56
400-6	38	50	58	60	61	61	53	45
450-4	56	68	76	78	79	79	71	63
450-6	45	57	65	67	68	68	60	52
500-4	60	72	80	82	83	80	73	65
500-6	50	62	70	72	73	70	63	55
630-6	50	64	72	76	75	72	66	60
630-8	43	57	65	69	68	65	59	53
710-6	54	68	76	80	79	76	70	64
710-8	46	60	68	72	71	68	62	56
800-6	57	71	79	83	72	79	73	67
800-8	50	64	72	76	72	72	66	60

Para obtener los espectros de potencia sonora Lwa en dB(A) en la aspiración a caudal máximo (Qmax), sumar al nivel de presión sonora LpA dado en las curvas características, los valores de la tabla siguiente:

Banda de frecuencia en Hz							
63	125	250	500	1000	2000	4000	8000
2	9	15	15	18	18	11	5

Dimensiones mm

RFH

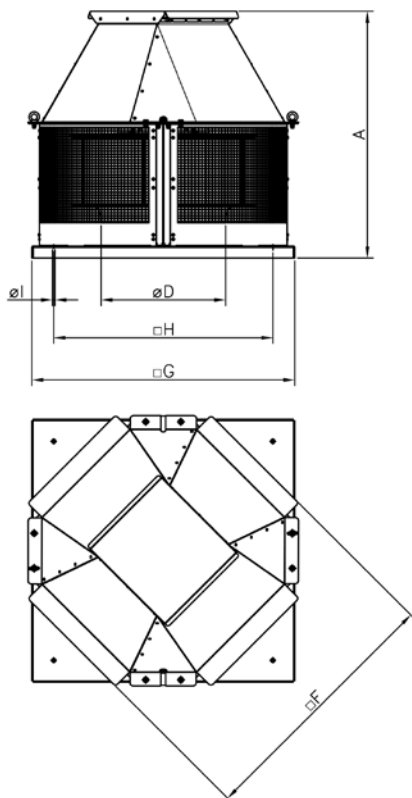

Modelo	A	ØD*	F	G	H	ØI
RFH-280	515	250	460	450	360	12
RFH-315	540	250	460	450	360	12
RFH-355	610	355	565	560	450	12
RFH-400	665	355	565	560	450	12
RFH-450	740	500	735	710	590	12
RFH-500	755	500	735	710	590	12
RFH-630	845	630	890	900	750	14
RFH-710	995	710	1110	1100	900	14
RFH-800	1065	710	1110	1100	900	14

(*) Diámetro nominal tubería recomendada

RFV

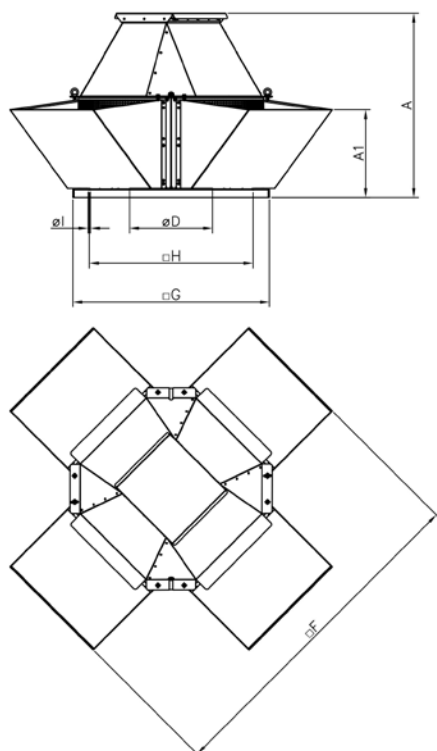

Modelo	A	A1	ØD*	F	G	H	ØI
RFV-280	515	235	250	800	450	360	12
RFV-315	540	235	250	800	450	360	12
RFV-355	610	305	355	1045	560	450	12
RFV-400	665	305	355	1045	560	450	12
RFV-450	740	340	500	1255	710	590	12
RFV-500	755	340	500	1255	710	590	12
RFV-630	845	400	630	1550	900	750	14
RFV-710	995	455	710	1875	1100	900	14
RFV-800	1065	455	710	1875	1100	900	14

(*) Diámetro nominal tubería recomendada

Curvas características

Q= Caudal en m³/h, m³/s y cfm.

Pe= Presión estática en mmH₂O, Pa e inwg.

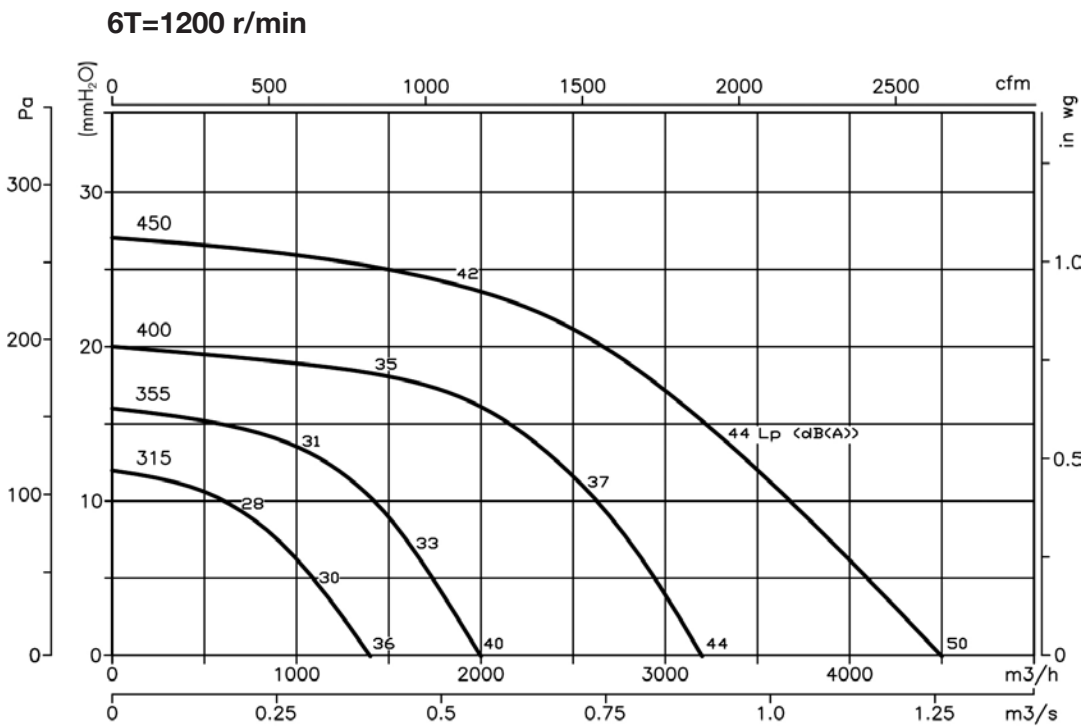
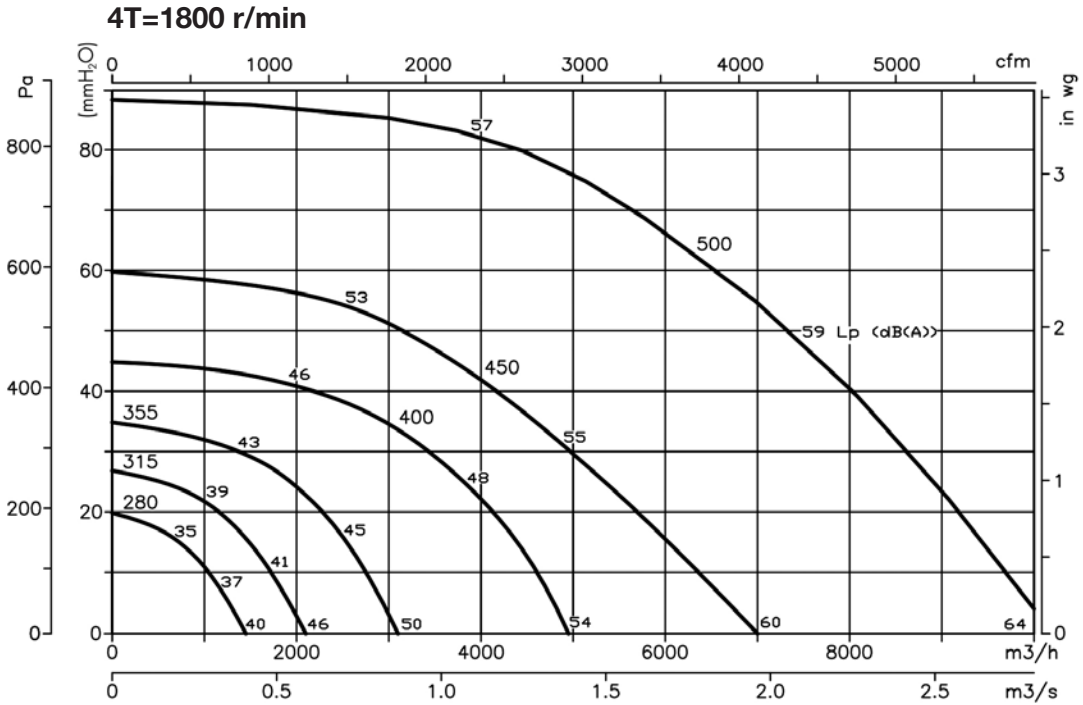

Curvas características

Q= Caudal en m³/h, m³/s y cfm. Pe= Presión estática en mmH₂O, Pa e inwg.

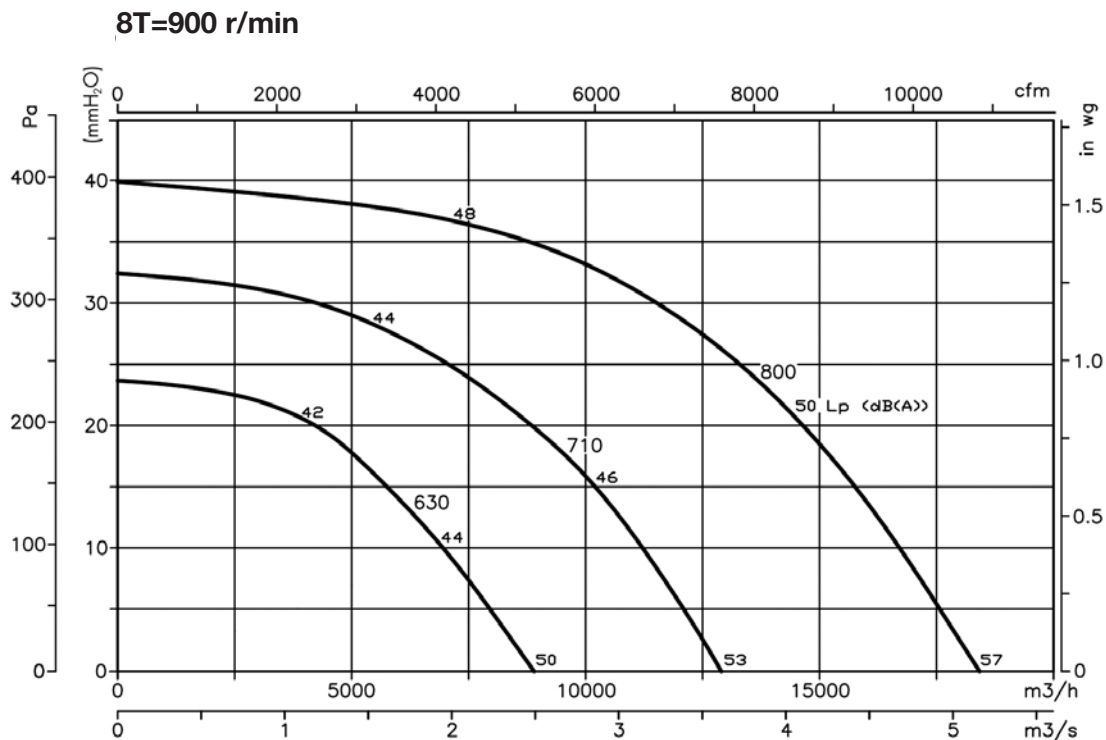
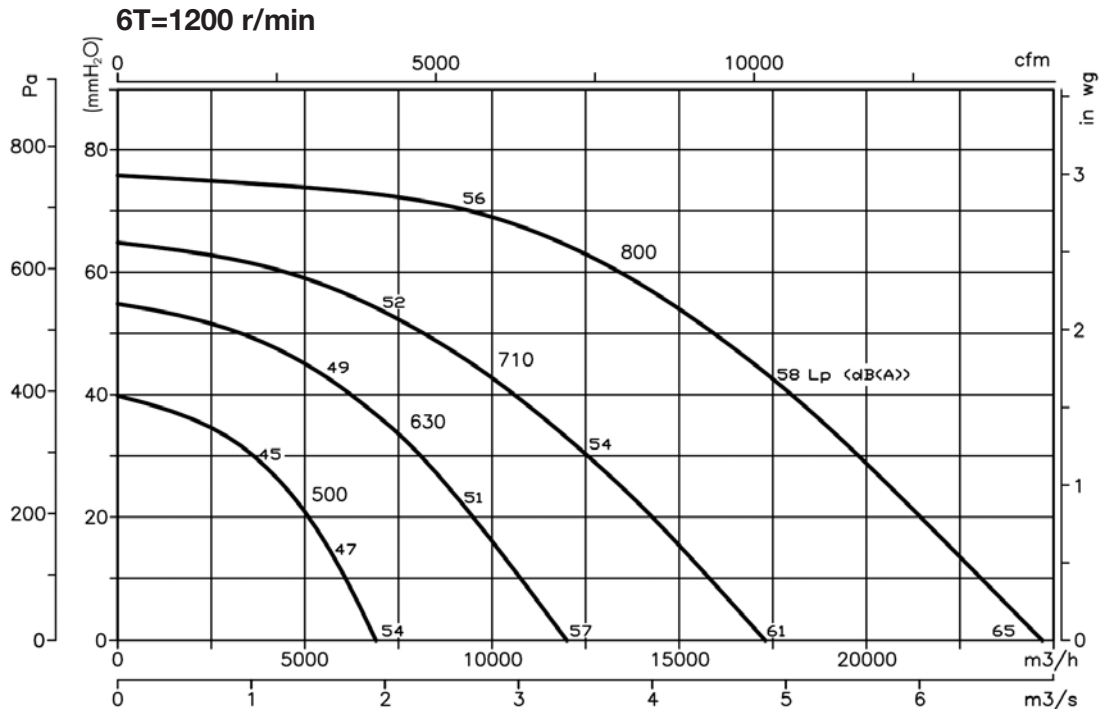

CRF



Extractores centrífugos de tejado, con bajo nivel sonoro

Extractores centrífugos de tejado, de bajo nivel sonoro, con motor de rotor exterior.

Ventilador:

- Construcción en chapa de acero galvanizado.
- Turbina con álabes a reacción, en chapa de aluminio excepto modelos 225 y 250 en chapa de acero.
- Rejilla de protección antipájaros.
- Cuerpo abatible para facilitar la inspección y el mantenimiento.

Motor:

- Motores clase F, de rotor exterior, protección IP54
- Monofásicos 230V.-50/60Hz, excepto modelos 450 y 500 230V. 60Hz
- Motor Multitensión, diseño especial válido para: 220/380V 60Hz, 254/440V 60Hz, 265/460V 60Hz, 277/480V 60Hz
- Temperatura máxima del aire a transportar: -25°C.+ 50°C.

Acabado:

- Anticorrosivo en chapa de acero galvanizado.

Bajo demanda:

- El variador electrónico de velocidad (VSD) se suministra bajo demanda

Código de pedido

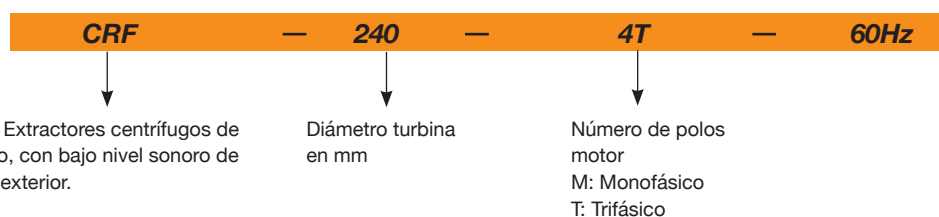

60Hz

Características técnicas

Modelo	Velocidad (r/min)	Intensidad máxima admisible (A)		Potencia eléctrica máxima (kW)	Caudal máximo (m³/h)	Nivel presión sonora dB(A) ⁽¹⁾		Peso (Kg)	VSD Recomendado
		220-277V	380-480V			Aspiración	Descarga		
CRF-225-4M	1704	0,20		0,04	650	32,55	38,85	11	VSD1/M-0.5
CRF-250-4M	1728	0,31		0,06	950	33,60	39,90	12	VSD1/M-0.5
CRF-250-4T	1740		0,28	0,06	950	33,60	39,90	12	VSD3/A-RFT-1
CRF-315-4M	1680	0,60		0,14	2000	40,95	47,25	17	VSD1/M-0.5
CRF-315-4T	1716		0,35	0,14	2000	40,95	47,25	17	VSD3/A-RFT-1
CRF-315-6M	1128	0,38		0,08	1280	29,40	35,70	17	VSD1/M-0.5
CRF-315-6T	1080		0,20	0,07	1280	29,40	35,70	17	VSD3/A-RFT-1
CRF-355-4M	1680	0,75		0,17	2500	45,15	50,40	24	VSD1/M-0.5
CRF-355-4T	1680		0,45	0,18	2500	45,15	50,40	24	VSD3/A-RFT-1
CRF-355-6M	1116	0,46		0,10	1800	32,55	39,90	24	VSD1/M-0.5
CRF-355-6T	1140		0,32	0,10	1800	32,55	39,90	24	VSD3/A-RFT-1
CRF-400-4M	1620	1,20		0,26	2810	48,30	54,60	28	VSD1/M-0.5
CRF-400-4T	1656		0,60	0,27	2810	48,30	54,60	28	VSD3/A-RFT-1
CRF-400-6M	1128	0,72		0,14	2400	36,75	43,05	28	VSD1/M-0.5
CRF-400-6T	1080		0,40	0,15	2400	36,75	43,05	28	VSD3/A-RFT-1
CRF-450-4M	Disponible próximamente								
CRF-450-4T	Disponible próximamente								
CRF-450-6M	Disponible próximamente								
CRF-450-6T	Disponible próximamente								
CRF-500-4T	Disponible próximamente								
CRF-500-6M	Disponible próximamente								
CRF-500-6T	Disponible próximamente								

(1) Los valores de los niveles sonoros, son presiones en db(A), medidos a 6 metros, y a 2/3 del caudal máximo (2/3 Qmáx.)

Características acústicas

Espectro de potencia sonora $L_w(A)$ en dB(A) por banda de frecuencia en Hz.

Valores tomados a la aspiración con 2/3 caudal máximo (2/3 Q_{max}).

Modelo	63	125	250	500	1000	2000	4000	8000
225	29	35	46	49	50	46	44	38
250	30	36	47	50	51	47	45	39
315-4	40	49	54	54	58	57	50	44
315-6	29	38	43	43	47	46	39	33
355-4	44	53	58	58	62	61	54	48
355-6	32	41	46	46	50	49	42	36
400-4	48	54	60	60	63	66	57	51
400-6	37	43	49	49	52	55	46	40

Valores tomados a la descarga con 2/3 caudal máximo (2/3 Q_{max}).

Modelo	63	125	250	500	1000	2000	4000	8000
225	33	38	52	54	55	55	50	45
250	34	39	53	55	56	56	51	46
315-4	39	48	58	62	65	62	55	49
315-6	28	37	47	51	54	51	44	38
355-4	42	51	61	65	68	65	58	52
355-6	32	41	51	55	58	55	48	42
400-4	47	59	67	69	70	70	62	54
400-6	36	48	56	58	59	59	51	43

Para obtener los espectros de potencia sonora L_{wa} en dB(A) en la aspiración a caudal máximo (Q_{max}), sumar al nivel de presión sonora L_pA dado en las curvas características, los valores de la tabla siguiente:

Banda de frecuencia en Hz								
63	125	250	500	1000	2000	4000	8000	
2	9	15	15	18	18	11	5	

Dimensiones mm

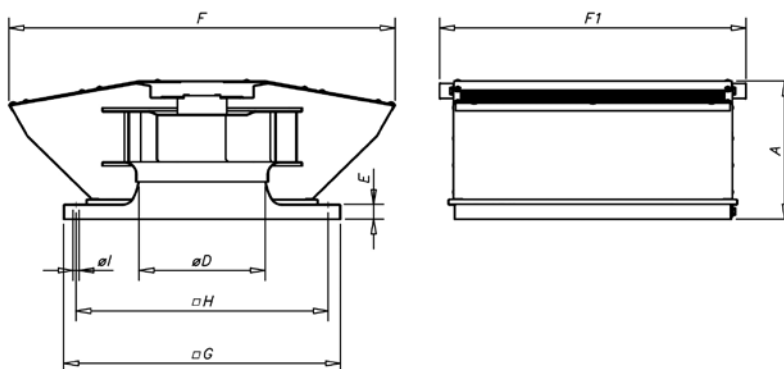

Modelo	A	ØD*	E	F	F1	G	H	øI
CRF-225	185	200	30	475	420	355	305	12
CRF-250	185	250	30	515	460	400	350	12
CRF-315	265	250	30	690	510	450	400	12
CRF-355	280	355	30	780	620	560	510	12
CRF-400	280	355	30	780	620	560	510	12

(*) Diámetro nominal tubería recomendada

Accesorios



INT

RM

VSD3/A-RFT

VSD1/A-RFM
VSD3/A-RFT

CUADROS

PA

MS

PT

SI

Curvas características

Q= Caudal en m³/h, m³/s y cfm.

Pe= Presión estática en mmH₂O, Pa e inwg.

4T/4M=1500 r/min

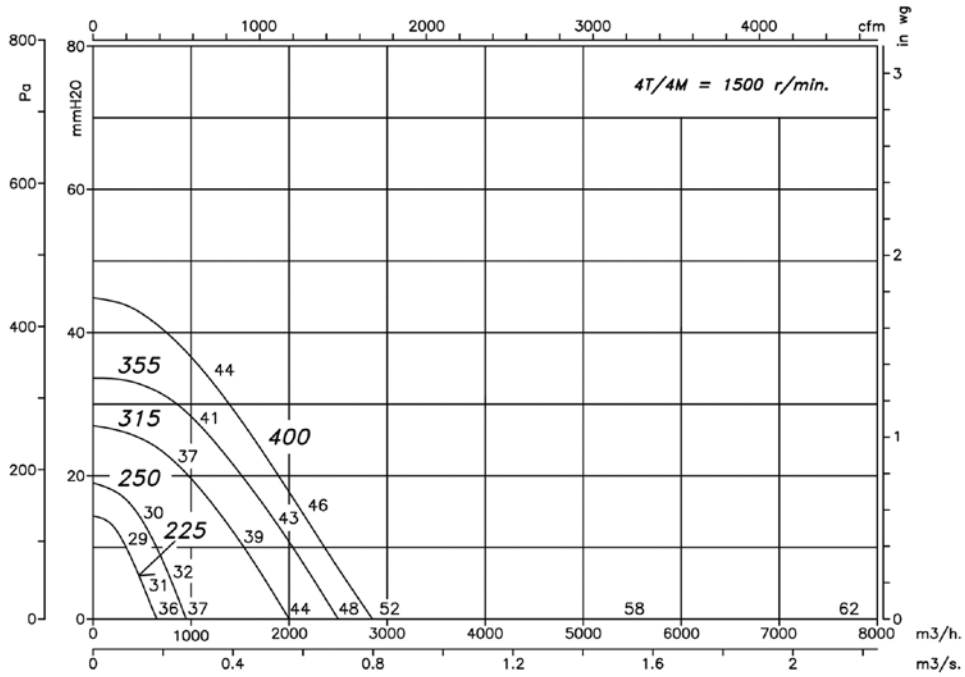

Los niveles sonoros Lp (dB(A)) indicados en las curvas, son presiones medidas a 6 metros, a la aspiración y en campo libre

6T/6M=1000 r/min

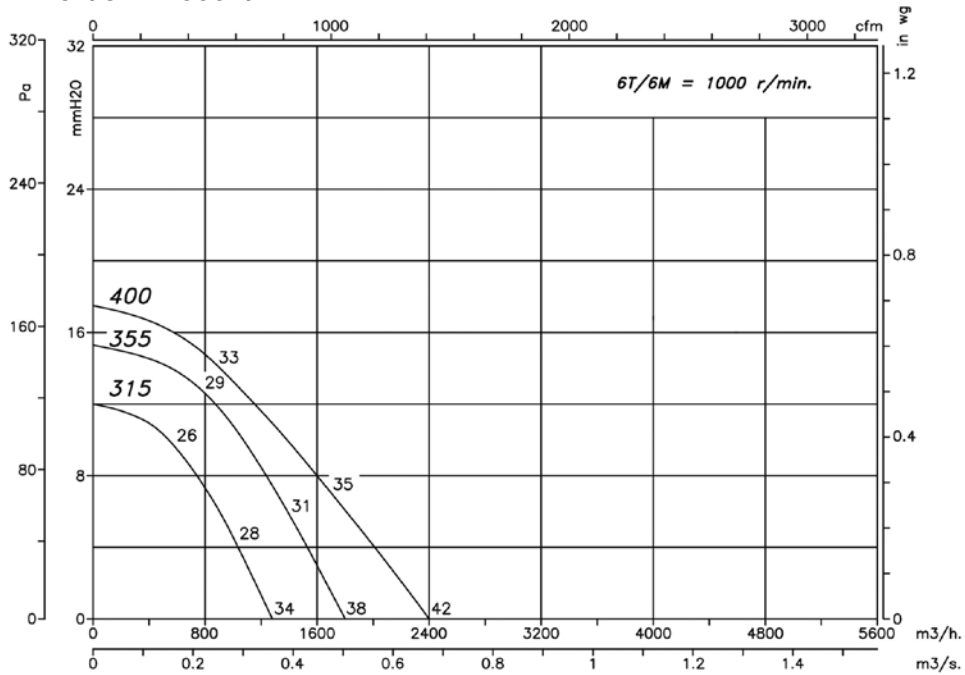

Los niveles sonoros Lp (dB(A)) indicados en las curvas, son presiones medidas a 6 metros, a la aspiración y en campo libre

HT

Extractores helicoidales de tejado, con base plana

Extractores helicoidales de tejado, con hélice de plástico reforzada en fibra de vidrio, con base plana para instalación en el tejado.

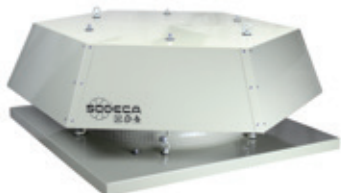

HT 25...63

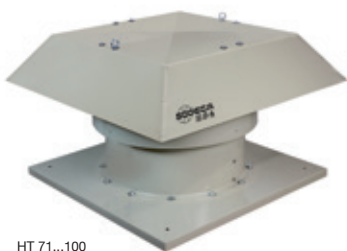

HT 71...100

Ventilador:

- Base soporte en chapa de acero galvanizada pintada.
- Hélices en poliamida 6 reforzada con fibra de vidrio, excepto modelos 100 de 4 polos en aluminio.
- Rejilla de protección antipájaros
- Sombrete deflector antilluvia en chapa de acero galvanizada pintada, con protección anticorrosiva.
- Dirección aire motor-hélice.

Motor:

- Motores de eficiencia IE3 para potencias iguales o superiores a 0,75kW, excepto monofásicos, 2 velocidades y 8 polos.
- Motores clase F, con rodamientos a bolas, protección IP55, excepto modelos monofásicos desde el tamaño 45 hasta el tamaño 63, protección IP54.
- Motor Multitensión, diseño especial válido para: 220/380V 60Hz, 254/440V 60Hz, 265/460V 60Hz, 277/480V 60Hz
- Temperatura máxima del aire a transportar: -25°C+ 60°C

Acabado:

- Anticorrosivo en resina de poliéster polimerizada a 190 °C, previo desengrase con tratamiento nanotecnológico libre de fosfatos.

Bajo demanda:

- Posibilidad de suministro como VENTILADORES DE IMPULSIÓN
- Hélices versión AL en fundición de aluminio.
- Bobinados especiales para diferentes tensiones
- Certificación ATEX Categoría 2

Código de pedido

HT	—	25	—	4T	—	I	—	60Hz
↓		↓		↓		↓		
Extractores helicoidales de tejado, con base plana		Diámetro hélice en cm		Número de polos motor 2=3500 r/min. 60 Hz 4=1680 r/min. 60 Hz 6=1080 r/min. 60 Hz		M=Monofásico T=Trifásico		I: Ventiladores para extracción A: Ventiladores para impulsión

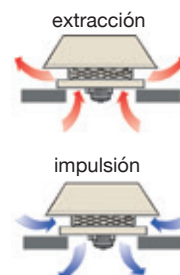
60Hz

Características técnicas

Modelo	Velocidad (r/min)	Intensidad máxima admisible (A)		Potencia instalada (kW)	Caudal máximo (m³/h)	Nivel de presión sonora dB(A)		Peso aprox. (Kg)
		220-277V	380-480V			Aspiración	Descarga	
HT-25-4T	1740	0,65	0,38	0,09	1080	41	40	12,5
HT-25-4M	1740	0,65		0,10	1080	41	40	12,5
HT-31-4T	1716	0,65	0,38	0,09	1800	47	46	13,3
HT-31-4M	1716	0,83		0,09	1800	47	46	13,5
HT-35-4T	1632	0,65	0,38	0,09	2600	48	47	17,5
HT-35-4M	1632	0,83		0,09	2600	48	47	17,5
HT-40-4T	1680	1,66	0,96	0,25	4600	51	50	21
HT-40-4M	1680	2,00		0,25	4600	51	50	21
HT-45-4T	1656	2,02	1,17	0,37	6500	55	53	29
HT-45-4M	1650	2,76		0,37	6500	55	54	30,5
HT-50-4T	1656	2,92	1,69	0,55	8500	59	57	36
HT-50-4M	1620	4,40		0,55	8500	59	57	39
HT-56-4T	1740	3,10	1,79	0,75	9800	61	57	35
HT-56-4M	1740	5,05		0,75	9800	61	57	37
HT-56-6T	1140	1,51	0,87	0,25	6600	48	46	46
HT-56-6M	1140	2,07		0,25	6600	48	46	46
HT-63-4T	1740	4,03	2,32	1,10	14000	63	59	65,8
HT-63-6T	1140	2,24	1,30	0,37	9200	52	49	61,8
HT-63-6M	1140	2,69		0,37	9200	52	49	61,8
HT-71-4T	1740	5,96	3,44	1,50	18000	69	67	64

Características técnicas

Modelo	Velocidad (r/min)	Intensidad máxima admisible (A)		Potencia instalada (kW)	Caudal máximo (m³/h)	Nivel de presión sonora dB(A)		Peso aprox. (Kg)
		220-277V	380-480V			Aspiración	Descarga	
HT-71-6T	1140	2,99	1,73	0,55	12200	58	56	64,9
HT-71-6M	1140	3,84		0,55	12200	58	56	64,9
HT-80-4T	1740	8,36	4,83	2,20	26200	73	70	87,8
HT-80-6T	1140	4,88	2,82	1,10	18000	64	61	81,8
HT-90-4T	1740	10,96	6,33	3,00	31500	77	74	94
HT-90-6T	1140	6,42	3,71	1,50	21200	68	65	91
HT-100-4T-7,5	1740		11,60	5,50	37000	80	77	114
HT-100-4T-10	1740		13,90	7,50	44000	84	81	125
HT-100-6T-2	1128	6,42	3,71	1,50	25000	71	68	102
HT-100-6T-3	1152	9,30	5,30	2,20	28200	75	72	106

Características acústicas

Los valores indicados, se determinan mediante medidas de nivel de presión y potencia sonora en dB (A) obtenidas en campo libre a una distancia de 6 mts.

Espectro de potencia sonora Lw(A) en dB(A) banda de frecuencia en [Hz]

Valores tomados a la aspiración con caudal máximo (Qmax)

Modelo	63	125	250	500	1000	2000	4000	8000
25	27	37	54	54	62	58	51	42
31	33	43	60	60	68	64	57	48
35	34	44	61	61	69	65	58	49
40	28	45	57	65	70	70	66	59
45	32	49	61	69	74	74	70	63
50	36	53	65	73	78	78	74	67
56-4	38	55	67	75	80	80	76	69
56-6	25	42	54	62	67	67	63	56
63-4	40	57	69	77	82	82	78	71
63-6	29	46	58	66	71	71	67	60
71-4	46	63	75	83	88	88	84	77
71-6	35	52	64	72	77	77	73	66
80-4	57	78	85	90	93	89	82	71
80-6	48	69	76	81	84	80	73	62
90-4	61	82	89	94	97	93	86	75
90-6	52	73	80	85	88	84	77	66
100-4-7,5	64	85	92	97	100	96	89	78
100-4-10	68	89	96	101	104	100	93	82
100-6-2	55	76	83	88	91	87	80	69
100-6-3	59	80	87	92	95	91	84	73

Valores tomados a la descarga con caudal máximo (Qmax)

Modelo	63	125	250	500	1000	2000	4000	8000
25	26	36	53	53	61	57	50	41
31	32	42	59	59	67	63	56	47
35	33	43	60	60	68	64	57	48
40	27	44	56	64	69	69	65	58
45	30	47	59	67	72	72	68	61
50	34	51	63	71	76	76	72	65
56-4	34	51	63	71	76	76	72	65
56-6	23	40	52	60	65	65	61	54
63-4	36	53	65	73	78	78	74	67
63-6	26	43	55	63	68	68	64	57
71-4	44	61	73	81	86	86	82	75
71-6	33	50	62	70	75	75	71	64
80-4	54	75	82	87	90	86	79	68
80-6	45	66	73	78	81	77	70	59
90-4	58	79	86	91	94	90	83	72
90-6	49	70	77	82	85	81	74	63
100-4-7,5	61	82	89	94	97	93	86	75
100-4-10	65	86	93	98	101	97	90	79
100-6-2	52	73	80	85	88	84	77	66
100-6-3	56	77	84	89	92	88	81	70

Dimensiones mm

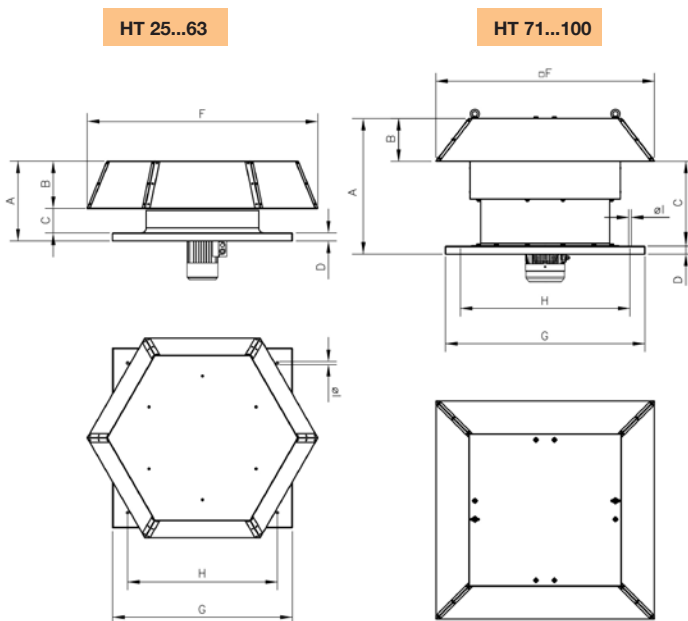

Modelo	A	B	C	D	F	G	H	I
HT-25	223	140	43	40	635	450	360	12
HT-31	245	140	65	40	635	500	410	12
HT-35	270	169	61	40	808	560	450	12
HT-40	295	169	86	40	808	630	530	12
HT-45	342	202	90	50	923	710	590	12
HT-50	373	238	85	50	1154	800	680	12
HT-56	402	238	124	40	1154	900	750	14
HT-63	457	277	141	40	1384	1000	850	14
HT-71	759	195	524	40	1123	1000	850	14
HT-80	790	216	524	50	1252	1150	1000	14
HT-90	920	232	638	50	1380	1150	1000	14
HT-100	1055	252	753	50	1527	1250	1100	14

Curvas características

Q= Caudal en m³/h, m³/s y cfm.

Pe= Presión estática en mmH₂O, Pa e inwg.

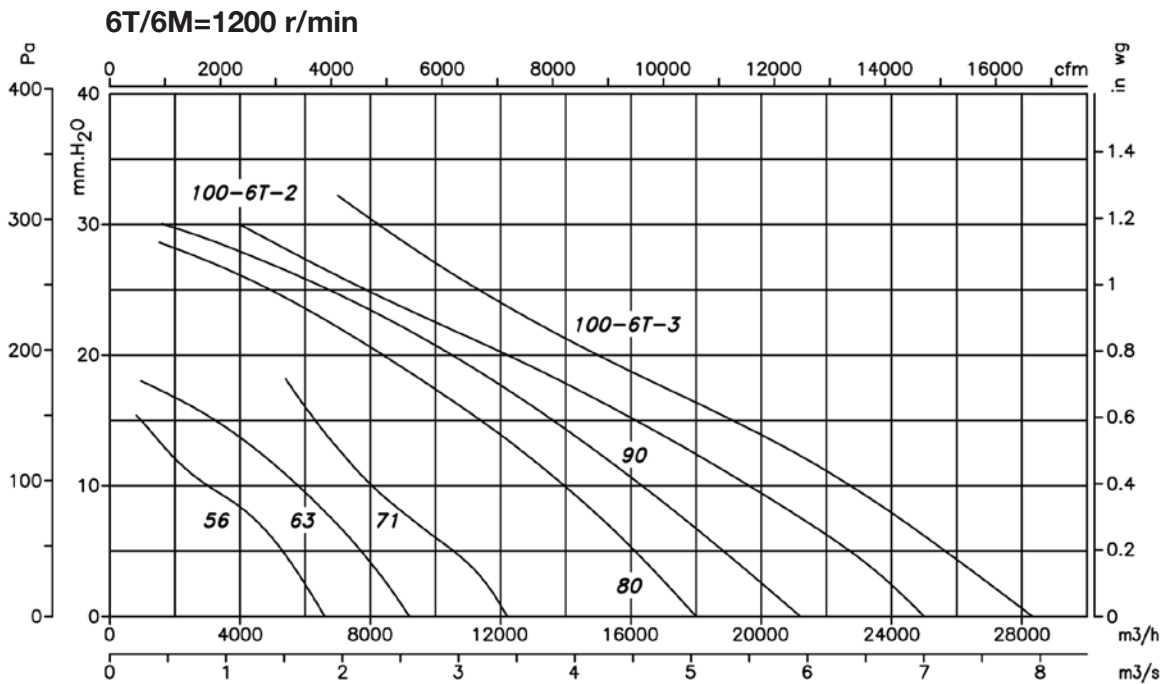
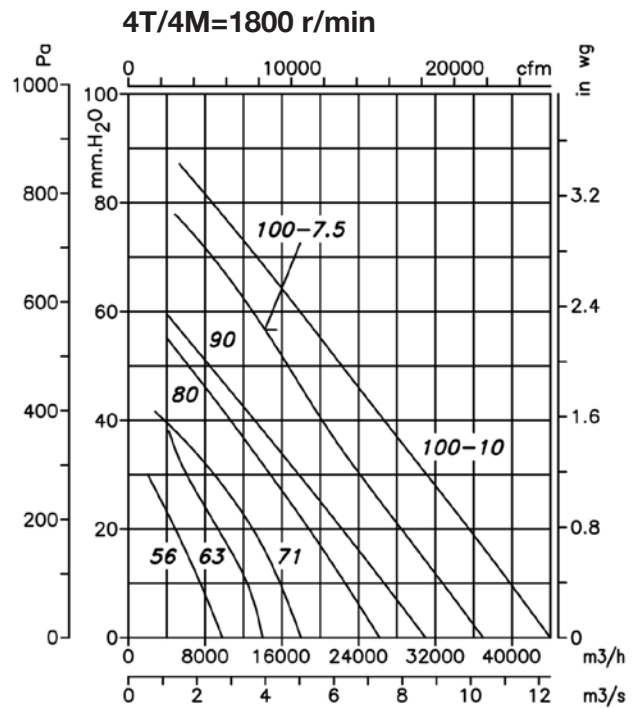
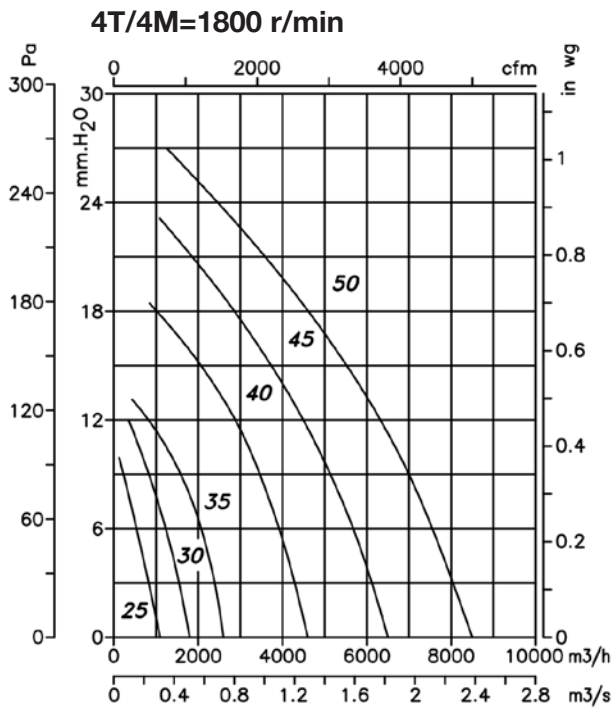

Accesorios



HTMH



Extractores de cubierta multifuncional para grandes caudales

Extractores de cubierta multifuncionales de robusta construcción para extracción de grandes caudales.

Ventilador:

- Base soporte en chapa de acero galvanizada pintada
- Hélices orientables en fundición de aluminio
- Rejilla de protección contra contactos según norma UNE-EN ISO 12499
- Sombbrero en chapa de acero galvanizada pintada, con salida de aire natural.

Motor:

- Motores de eficiencia IE3 para potencias iguales o superiores a 0,75kW, excepto monofásicos, 2 velocidades y 8 polos.
- Motores clase F, con rodamientos a bolas, protección IP55, de 1 ó 2 velocidades según modelo
- Motor Multitensión, diseño especial válido para: 220/380V 60Hz, 254/440V 60Hz, 265/460V 60Hz, 277/480V 60Hz
- Temperatura de trabajo : -25°C.+ 50°C.

- Calidad acabado superficial C4H

Bajo demanda:

- Motores ATEX y de 2 Velocidades
- Construcción total en acero inoxidable
- Construcción en acero galvanizado en caliente
- Motores marinos para aplicaciones navales, con certificación para servicio esencial según diferentes entidades de clasificación (BV, DNV, LR)
- Motores CE, NEMA, UL, CSA
- Calidad acabado superficial C5M

Acabado:

- Anticorrosivo en resina de poliéster polimerizada a 190 °C, previo desengrase con tratamiento nanotecnológico libre de fosfatos.

Código de pedido

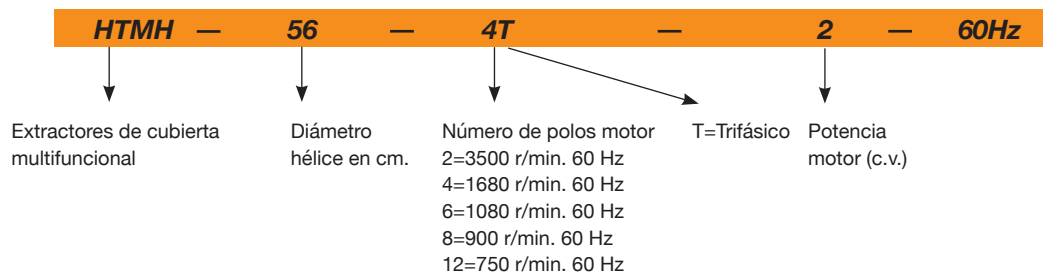

60Hz

Características técnicas

Modelo	Velocidad (r/min)	Intensidad máxima admisible (A)		Potencia instalada (kW)	Caudal máximo (m³/h)	Nivel presión (1) sonora dB(A)		Peso aprox. (Kg)
		220-277V	380-480V			Aspiración	Descarga	
HTMH-56-4T-1	1692	2,83	1,63	0,75	10545	65,10	61,95	67
HTMH-56-4T-1.5	1680	4,03	2,32	1,10	11400	66,15	63,00	69
HTMH-56-4/8T-1.5	1728 / 852		2,90 / 1,30	1,10 / 0,25	11400 / 5700	66,15 / 50,40	63,00 / 47,25	67
HTMH-56-6T-0.75	1092	2,59	1,49	0,55	8170	53,55	51,45	67
HTMH-63-4T-1.5	1680	4,03	2,32	1,10	13870	68,25	65,10	81
HTMH-63-4/8T-1.5	1728 / 852		2,90 / 1,30	1,10 / 0,25	13870 / 6935	68,25 / 52,50	65,10 / 49,35	79
HTMH-63-4T-2	1728	5,67	3,26	1,50	15485	69,30	66,15	87
HTMH-63-4/8T-2	1704 / 840		3,50 / 1,50	1,50 / 0,37	15485 / 7742	69,30 / 53,55	66,15 / 50,40	80
HTMH-63-4T-3	1722	8,07	4,64	2,20	17955	70,35	67,20	96
HTMH-63-4/8T-3	1716 / 852		4,90 / 1,70	2,20 / 0,45	17955 / 8977	70,35 / 54,60	67,20 / 51,45	86
HTMH-63-6T-0.75	1092	2,59	1,49	0,55	10260	58,8	56,70	79
HTMH-63-6T-1	1110	3,39	1,95	0,75	11305	59,85	57,75	84
HTMH-71-4T-2	1728	5,67	3,26	1,50	16150	72,45	69,30	93
HTMH-71-4/8T-2	1704 / 840		3,50 / 1,50	1,50 / 0,37	16150 / 8075	72,45 / 56,70	69,30 / 53,55	86
HTMH-71-4T-3	1722	8,07	4,64	2,20	18430	74,55	71,40	101
HTMH-71-4/8T-3	1716 / 852		4,90 / 1,70	2,20 / 0,45	18430 / 9215	74,55 / 58,80	71,40 / 55,65	91
HTMH-71-4T-4	1704	10,70	6,17	3,00	22610	75,60	72,45	104

Características técnicas

Modelo	Velocidad (r/min)	Intensidad máxima admisible (A)		Potencia instalada (kW)	Caudal máximo (m³/h)	Nivel presión (1) sonora dB(A)		Peso aprox. (Kg)
		220-277V	380-480V			Aspiración	Descarga	
HTMH-71-4/8T-4	1716 / 852		6,50 / 2,30	3,00 / 0,60	22610 / 11305	75,60 / 59,85	72,45 / 56,70	98
HTMH-71-6T-1	1110	3,39	1,95	0,75	13205	60,90	58,80	90
HTMH-71-6T-1.5	1110	4,83	2,78	1,10	16245	61,95	59,85	94
HTMH-80-4T-4	1704	10,70	6,17	3,00	27600	76,65	73,50	127
HTMH-80-4/8T-4	1716 / 852		6,50 / 2,30	3,00 / 0,60	27600 / 13800	76,65 / 60,90	73,50 / 57,75	121
HTMH-80-4T-5.5	1728	14,10	8,12	4,00	30176	77,70	74,55	136
HTMH-80-4/8T-5.5	1716 / 852		8,20 / 2,90	4,00 / 0,80	30176 / 15088	77,70 / 61,95	74,55 / 58,80	125
HTMH-80-6T-1.5	1110	4,83	2,78	1,10	19412	65,10	63,00	117
HTMH-80-6T-2	1128	6,45	3,71	1,50	22172	66,15	64,05	122
HTMH-80-6T-3	1146	10,30	5,94	2,20	24932	67,20	65,10	132
HTMH-80-8T-1	846	4,68	2,70	0,75	16376	64,05	63,00	117
HTMH-90-4T-5.5	1728	14,10	8,12	4,00	35052	82,95	79,80	158
HTMH-90-4/8T-5.5	1716 / 852		8,20 / 2,90	4,00 / 0,80	35052 / 17526	82,95 / 67,20	79,80 / 64,05	147
HTMH-90-4T-7.5	1752		10,50	5,50	38456	85,05	81,90	176
HTMH-90-4/8T-7.5	1740 / 864		11,80 / 3,80	5,50 / 1,10	38456 / 19228	85,05 / 69,30	81,90 / 66,15	166
HTMH-90-4T-10 IE3	1758		13,90	7,50	41308	86,10	82,95	194
HTMH-90-4/8T-9	1752 / 870		15,30 / 5,40	7,50 / 1,50	41308 / 20654	86,10 / 70,35	82,95 / 67,20	175
HTMH-90-6T-3	1146	10,30	5,94	2,20	29256	71,40	69,30	154
HTMH-90-6/12T-3	1128 / 564		5,60 / 2,20	2,20 / 0,37	29256 / 14628	71,40 / 55,65	69,30 / 53,55	148
HTMH-90-6T-4	1152	12,70	7,30	3,00	32016	72,45	70,35	177
HTMH-90-6/12T-4	1152 / 576		9,00 / 3,50	3,00 / 0,55	32016 / 16008	72,45 / 56,70	70,35 / 54,60	166
HTMH-90-8T-1	846	4,68	2,70	0,75	17020	64,05	63,00	139
HTMH-90-8T-2	846	7,10	4,10	1,50	19596	66,15	65,10	150
HTMH-100-4T-7.5	1752		10,50	5,50	40756	88,20	85,05	200
HTMH-100-4/8T-7.5	1740 / 864		11,80 / 3,80	5,50 / 1,10	40756 / 20378	88,20 / 72,45	85,05 / 69,30	190
HTMH-100-4T-10 IE3	1758		13,90	7,50	47564	89,25	86,10	218
HTMH-100-4/8T-9	1752 / 870		15,30 / 5,40	7,50 / 1,50	44528 / 22264	88,20 / 72,45	85,05 / 69,30	199
HTMH-100-4T-15 IE3	1764		20,90	11,00	51336	90,30	87,15	253
HTMH-100-4/8T-14	1764 / 870		23,20 / 8,70	11,00 / 2,80	48300 / 24150	89,25 / 73,50	86,10 / 70,35	230
HTMH-100-6T-3	1146	10,30	5,94	2,20	32476	77,70	75,60	178
HTMH-100-6/12T-3	1128 / 564		5,60 / 2,20	2,20 / 0,37	32476 / 16238	77,70 / 61,95	75,60 / 59,85	172
HTMH-100-6T-4	1152	12,70	7,30	3,00	35420	78,75	76,65	201
HTMH-100-6/12T-4	1152 / 576		9,00 / 3,50	3,00 / 0,55	35420 / 17710	78,75 / 63,00	76,65 / 60,90	190
HTMH-100-6T-5.5	1152	16,50	9,46	4,00	40020	79,80	77,70	208
HTMH-100-6/12T-5.5	1164 / 576		11,00 / 4,00	4,00 / 0,65	40020 / 20010	79,80 / 64,05	77,70 / 61,95	200
HTMH-100-8T-3	846	9,53	5,50	2,20	26404	72,45	71,40	186
HTMH-100-8T-4	846	12,82	7,40	3,00	28704	73,50	72,45	193
HTMH-125-4T/3-10 IE3	1758		13,90	7,50	55250	78,75	75,60	337
HTMH-125-4T/3-15 IE3	1764		21,40	11,00	72150	79,80	76,65	382
HTMH-125-4T/3-20 IE3	1758		28,70	15,00	83120	81,90	78,75	377
HTMH-125-4T/6-15 IE3	1764		21,40	11,00	66800	79,80	76,65	398
HTMH-125-4T/6-20 IE3	1758		28,70	15,00	72900	79,80	76,65	393
HTMH-125-4T/9-20 IE3	1758		28,70	15,00	76310	78,75	75,60	408
HTMH-125-6T/6-5.5	1152	16,50	9,46	4,00	47760	66,15	64,05	343
HTMH-125-6T/6-7.5	1152		12,80	5,50	55600	66,15	64,05	347
HTMH-125-6T/6-10 IE3	1164		14,80	7,50	66170	68,25	66,15	369
HTMH-125-6T/6-15 IE3	1164		22,00	11,00	76380	70,35	68,25	399
HTMH-125-6T/9-7.5	1152		12,80	5,50	50000	67,20	65,10	362
HTMH-125-6T/9-10 IE3	1164		14,80	7,50	59340	67,20	65,10	384
HTMH-125-6T/9-15 IE3	1164		22,00	11,00	71890	70,35	68,25	414
HTMH-125-6T/9-20 IE3	1170		28,00	15,00	83660	73,50	71,40	467
HTMH-125-8T/6-4	846	12,82	7,40	3,00	47510	58,80	57,75	328
HTMH-125-8T/6-5.5	852	16,11	9,30	4,00	52770	60,90	59,85	345
HTMH-125-8T/6-7.5	852		12,00	5,50	60410	63,00	61,95	361
HTMH-125-8T/6-10	870		16,00	7,50	66030	64,05	63,00	389
HTMH-125-8T/9-5.5	852	16,11	9,30	4,00	51330	60,90	59,85	360
HTMH-125-8T/9-7.5	852		12,00	5,50	54480	64,05	63,00	376
HTMH-125-8T/9-10	870		16,00	7,50	65660	66,15	65,10	404
HTMH-125-8T/9-15	864		24,00	11,00	73870	67,20	66,15	426

(1) Los valores de los niveles sonoros, son presiones en dB(A) medidos a 6 metros, en campo libre.

Dimensiones mm

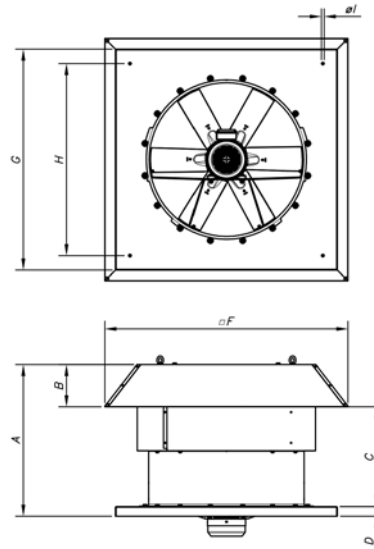

	A	B	C	D	F	G	H	I
HTMH-56	650	185	465	40	960	900	750	14
HTMH-63	680	215	465	40	1092	1000	850	14
HTMH-71	760	195	565	40	1120	1000	850	14
HTMH-80	790	215	575	50	1252	1150	1000	14
HTMH-90	910	232	678	50	1380	1150	1000	14
HTMH-100	1055	252	803	50	1527	1250	1100	14
HTMH-125	1170	310	859	50	1802	1425	1275	17

Validación de la presión sonora según distancia

El nivel sonoro puede variar dependiendo de la estructura de la cubierta o tejado.

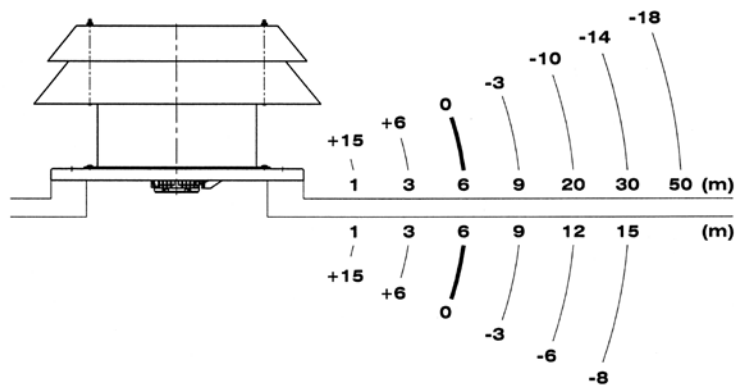

Accesorios



INT

AET

VSD3/A-RFT
VSD1/A-RFM

RT

Curvas características

Q= Caudal en m³/h, m³/s y cfm.

Pe= Presión estática en mmH₂O, Pa e inwg.

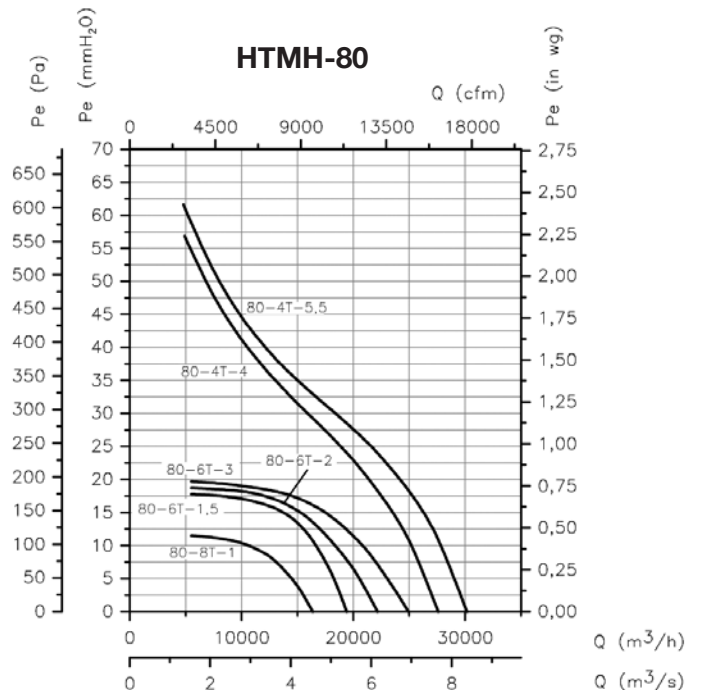
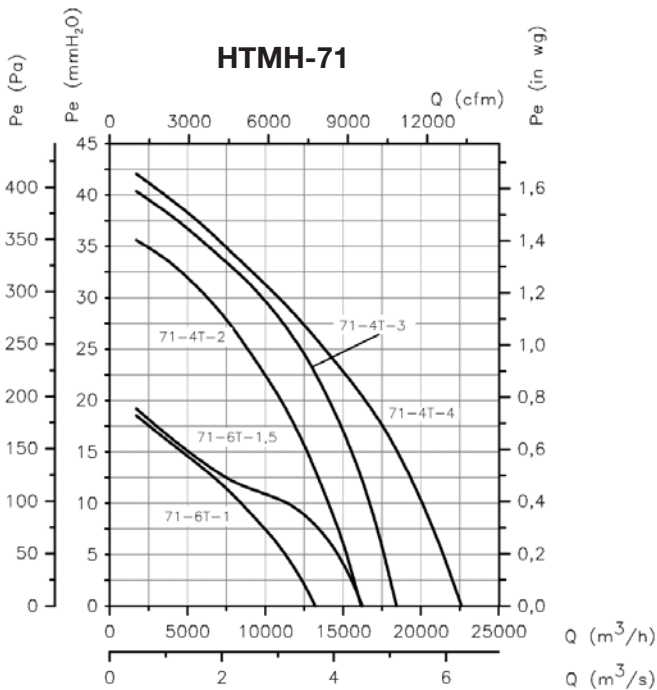
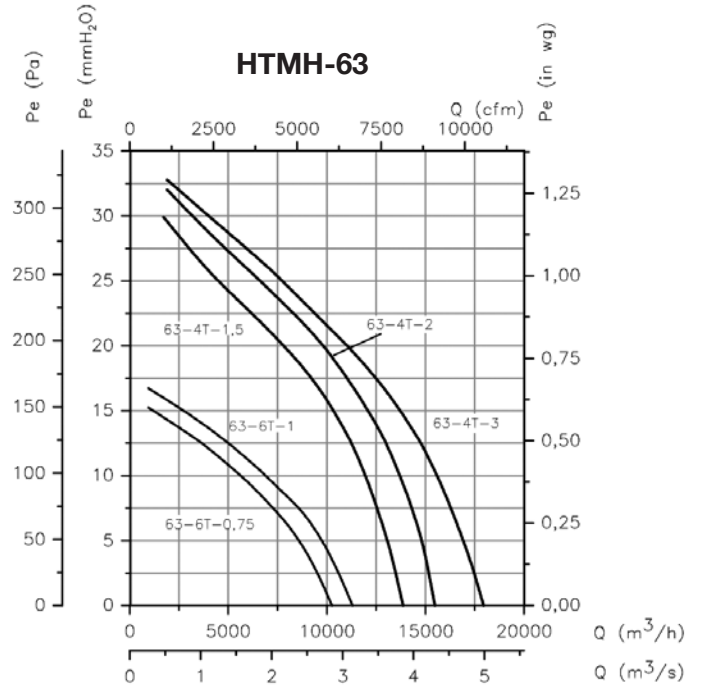
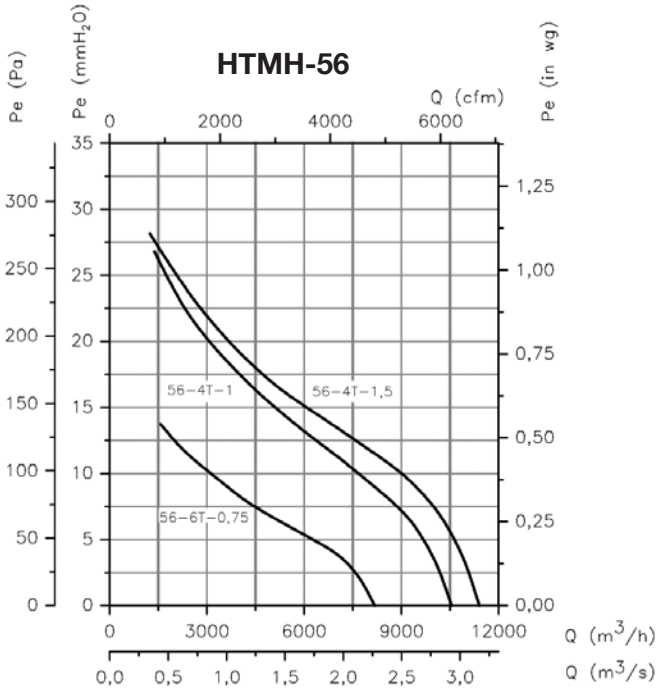

Curvas características

Q= Caudal en m³/h, m³/s y cfm.

Pe= Presión estática en mmH₂O, Pa e inwg.

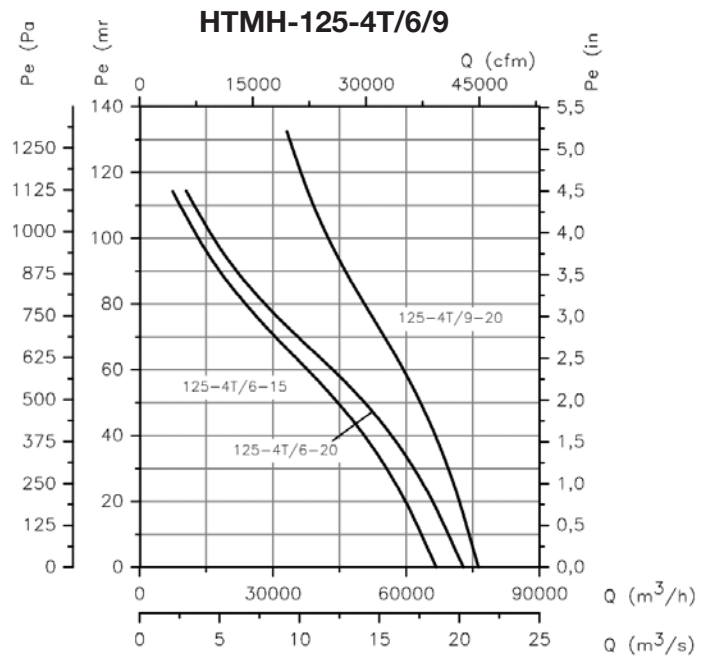
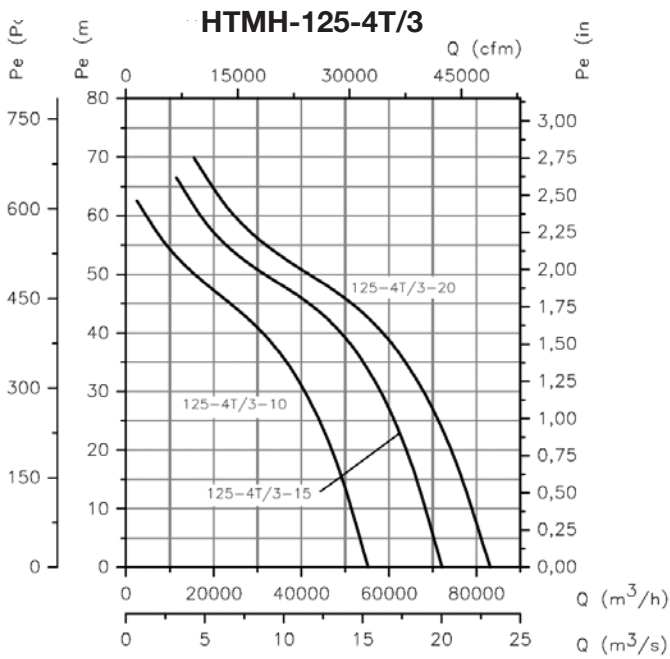
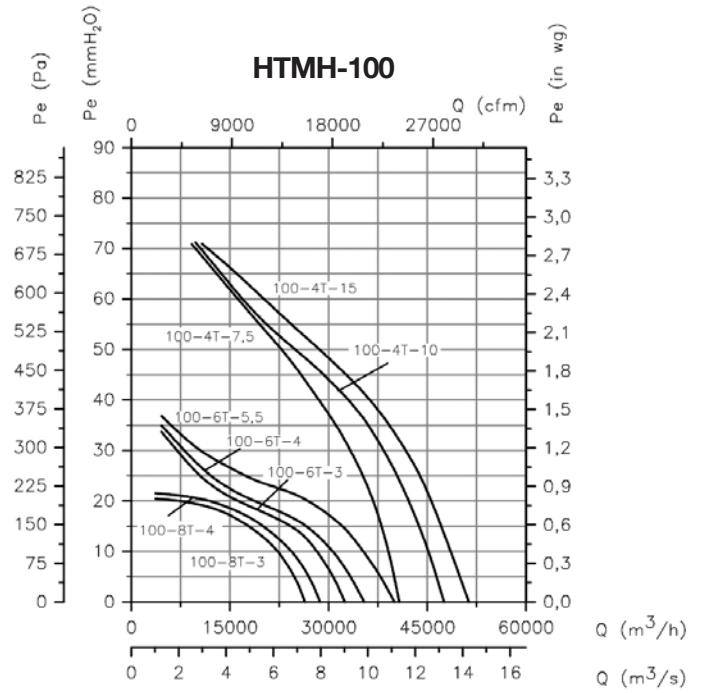
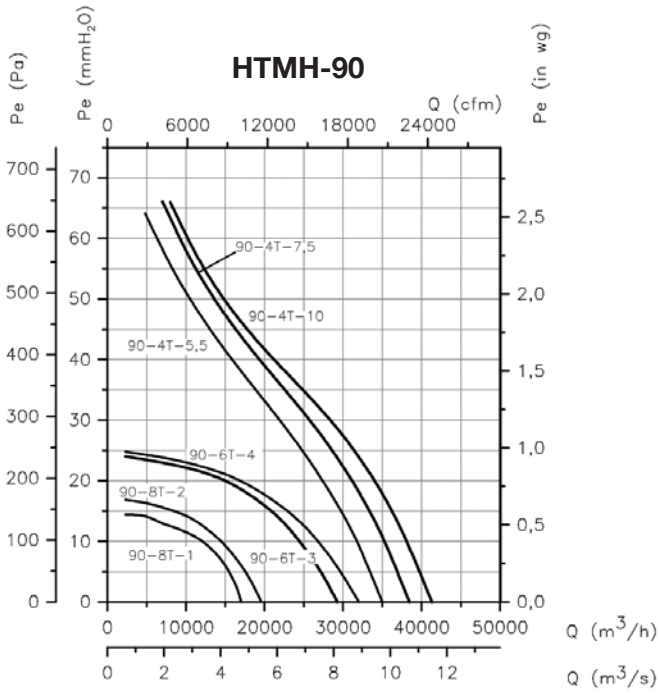

Curvas características

Q= Caudal en m³/h, m³/s y cfm.

Pe= Presión estática en mmH²O, Pa e inwg.

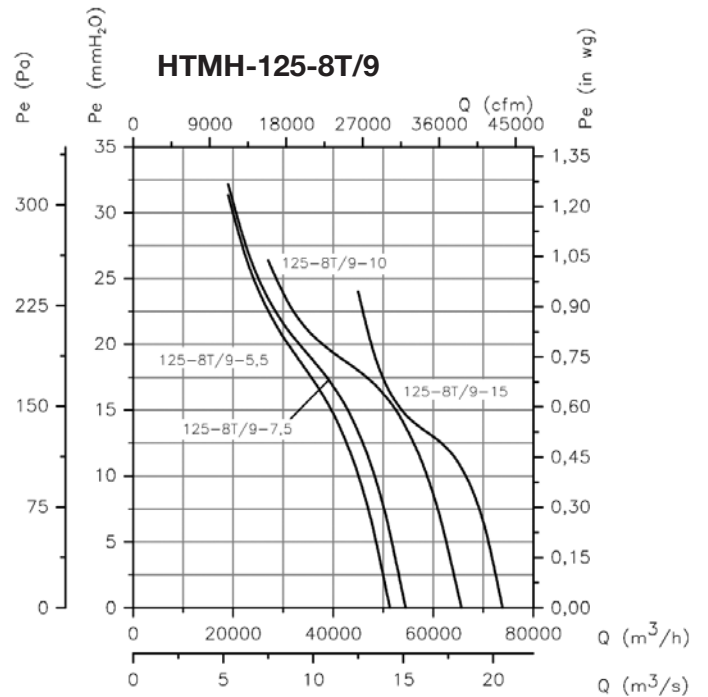
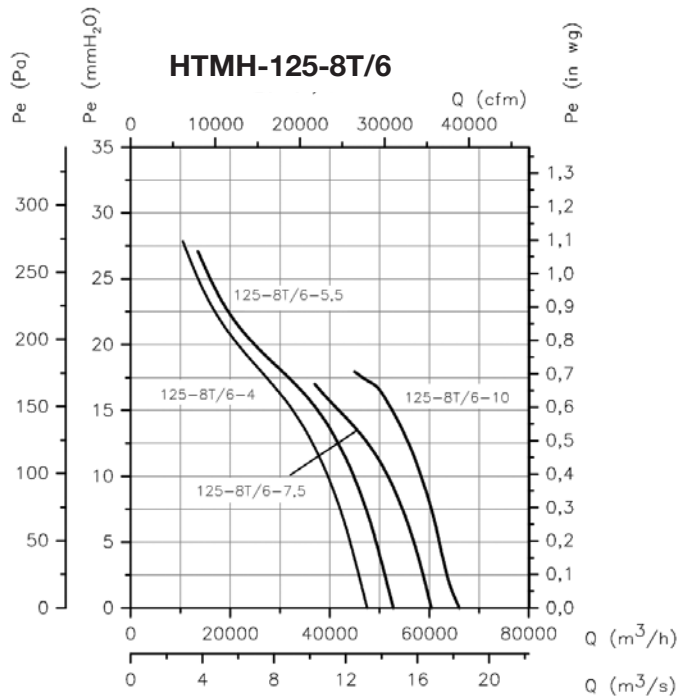
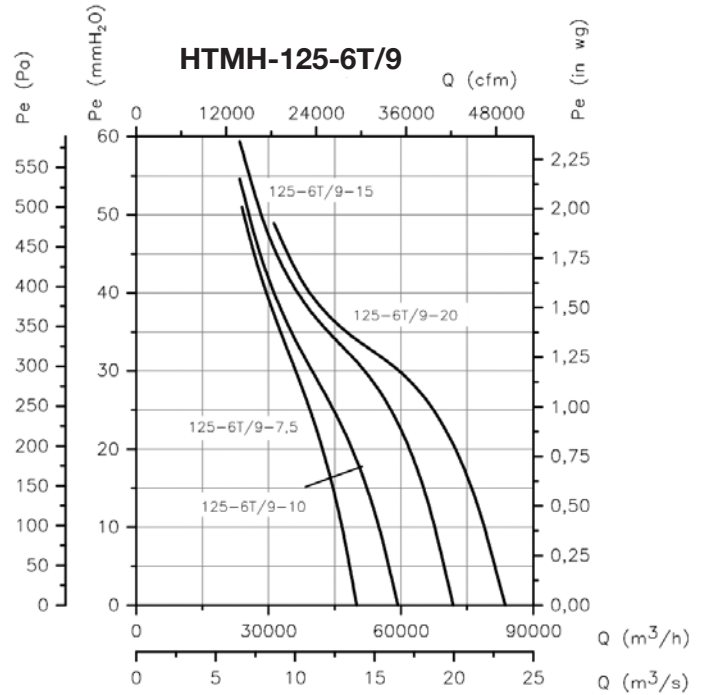
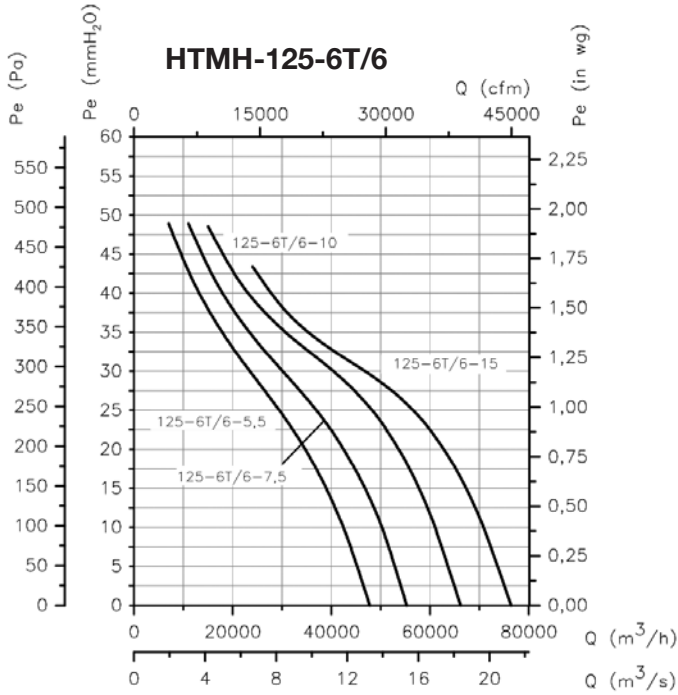

HTMV



Extractores helicoidales de cubierta con salida de aire vertical

Extractores helicoidales de cubierta con salida de aire vertical, diseñados para la extracción de gran cantidad de aire en naves industriales o similares.

Ventilador:

- Base soporte en chapa de acero galvanizada y tratamiento anticorrosivo
- Hélices orientables en fundición de aluminio.
- Rejilla de protección contra contactos según norma UNE-EN ISO 12499.
- Compuerta antiretorno en chapa de aluminio para evitar la entrada de agua cuando el ventilador no está en funcionamiento.
- Dirección aire motor-hélice.

Motor:

- Motores clase F, con rodamientos a bolas, protección IP55.
- Motores de eficiencia IE3 para potencias iguales o superiores a 0,75kW, excepto monofásicos, 2 velocidades y 8 polos
- Motor Multitensión, diseño especial válido para: 220/380V 60Hz, 254/440V 60Hz, 265/460V 60Hz, 277/480V 60Hz
- Temperatura máxima del aire a transportar: -20°C+ 40°C

Acabado:

- Anticorrosivo en resina de poliéster polimerizada a 190°C, previo desengrase con tratamiento nanotecnológico libre de fosfatos

Bajo demanda:

- Extractores con motor de 2 velocidades.
- Ventiladores de 2 y 8 polos según diámetro.
- Bobinados especiales para diferentes tensiones y frecuencias
- Construcción total en acero inoxidable
- Construcción en acero galvanizado en caliente

Código de pedido

De tamaño 40 a tamaño 100

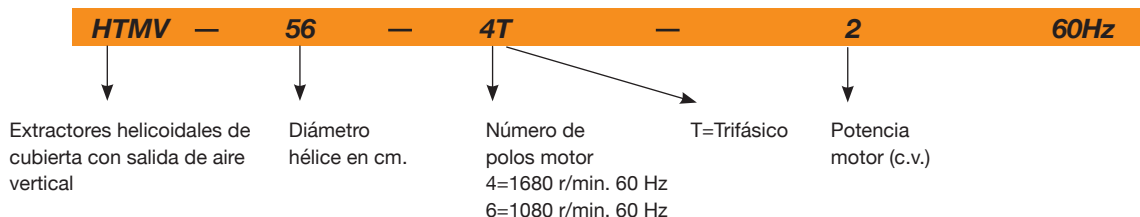

Tamaño 125

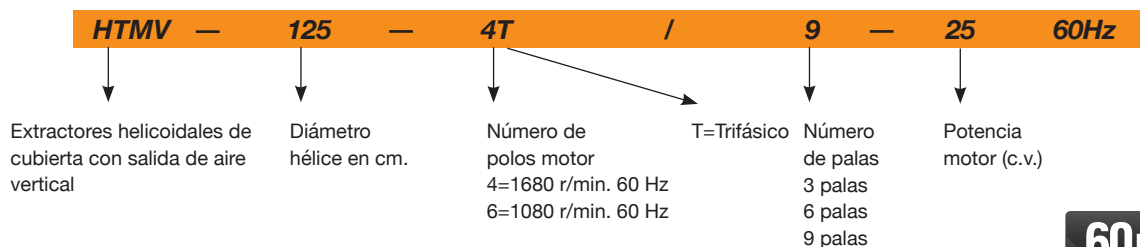

Características técnicas

60Hz

Modelo	Velocidad (r/min)	Intensidad máxima admisible (A)		Potencia instalada (kW)	Caudal máximo (m³/h)	Nivel presión (1) sonora dB(A)		Peso aprox. (Kg)
		220-277V	380-480V			Aspiración	Descarga	
HTMV-40-4T-0.75	1656	2,92	1,69	0,55	4800	53,55	48,30	39
HTMV-40-6T-0.75	1080	2,99	1,73	0,55	3150	42,00	37,80	47
HTMV-45-4T-0.75	1656	2,92	1,69	0,55	7450	57,75	52,50	42
HTMV-45-6T-0.75	1080	2,99	1,73	0,55	4450	44,10	39,90	50
HTMV-50-4T-1 IE3	1704	2,82	1,62	0,75	9750	61,95	56,70	54
HTMV-50-6T-0.75	1080	2,99	1,73	0,55	7000	49,35	45,15	57
HTMV-56-4T-1 IE3	1704	2,82	1,62	0,75	11250	66,15	60,90	61
HTMV-56-4T-1.5 IE3	1746	4,07	2,34	1,1	13600	67,20	61,95	60
HTMV-56-4T-2 IE3	1728	5,41	3,11	1,5	15050	68,25	63,00	71
HTMV-56-6T-0.75	1080	2,99	1,73	0,55	10150	54,60	50,40	60
HTMV-63-4T-1.5 IE3	1746	4,07	2,34	1,1	17800	66,15	61,95	69
HTMV-63-4T-2 IE3	1728	5,41	3,11	1,5	19300	66,15	61,95	81
HTMV-63-4T-3 IE3	1722	7,93	4,56	2,2	22150	68,25	64,05	83
HTMV-63-4T-4 IE3	1728	10,7	6,15	3	24250	69,30	65,10	93
HTMV-63-6T-0.75	1080	2,99	1,73	0,55	13600	57,75	53,55	70

Características técnicas

Modelo	Velocidad (r/min)	Intensidad máxima admisible (A)		Potencia instalada (kW)	Caudal máximo (m³/h)	Nivel presión (1) sonora dB(A)		Peso aprox. (Kg)
		220-277V	380-480V			Aspiración	Descarga	
HTMV-63-6T-1 IE3	1128	3,36	1,93	0,75	15900	59,85	55,65	72
HTMV-71-4T-2 IE3	1728	5,41	3,11	1,5	20900	71,40	67,20	88
HTMV-71-4T-3 IE3	1722	7,93	4,56	2,2	25100	70,35	66,15	90
HTMV-71-4T-4 IE3	1728	10,7	6,15	3	27500	71,40	67,20	100
HTMV-71-6T-0.75	1080	2,99	1,73	0,55	16100	58,80	55,65	77
HTMV-71-6T-1 IE3	1128	3,36	1,93	0,75	17300	59,85	55,65	79
HTMV-71-6T-1.5 IE3	1134	4,68	2,69	1,1	19950	60,90	56,70	90
HTMV-80-4T-4 IE3	1728	10,7	6,15	3	30250	74,55	70,35	122
HTMV-80-4T-5.5 IE3	1740	13,9	8	4	32750	74,55	70,35	125
HTMV-80-6T-1.5 IE3	1134	4,68	2,69	1,1	21450	64,05	59,85	112
HTMV-80-6T-2 IE3	1140	6,43	3,7	1,5	25950	65,10	60,90	120
HTMV-80-6T-3 IE3	1140	9,08	5,22	2,2	29950	66,15	61,95	122
HTMV-90-4T-5.5 IE3	1740	13,9	8	4	38900	78,75	74,55	138
HTMV-90-4T-7.5 IE3	1758		10,3	5,5	46150	77,70	73,50	185
HTMV-90-4T-10 IE3	1758		13,9	7,5	50150	76,65	72,45	141
HTMV-90-6T-2 IE3	1140	6,43	3,7	1,5	28800	67,20	63,00	133
HTMV-90-6T-3 IE3	1140	9,08	5,22	2,2	34000	68,25	63,00	136
HTMV-90-6T-4 IE3	1164	12	6,91	3	38900	69,30	65,10	172
HTMV-100-4T-7.5 IE3	1758		10,3	5,5	46850	82,95	78,75	196
HTMV-100-4T-10 IE3	1758		13,9	7,5	57400	80,85	76,65	152
HTMV-100-4T-15 IE3	1764		21,4	11	66300	79,80	75,60	231
HTMV-100-4T-20 IE3	1758		28,7	15	76150	81,90	77,70	222
HTMV-100-6T-3 IE3	1140	9,08	5,22	2,2	37600	70,35	67,20	148
HTMV-100-6T-4 IE3	1164	12	6,91	3	41150	70,35	65,10	184
HTMV-100-6T-5.5 IE3	1152	15,6	8,99	4	47800	71,40	67,20	177
HTMV-125-4T/3-25 IE3	1764		33,6	18,5	98350	85,05	79,80	428
HTMV-125-4T/3-30 IE3	1770		40,6	22	110350	86,10	80,85	443
HTMV-125-4T/3-40 IE3	1776		55,9	30	125000	87,15	81,90	489
HTMV-125-4T/6-25 IE3	1764		33,6	18,5	92550	84,00	78,75	437
HTMV-125-4T/6-30 IE3	1770		40,6	22	98850	84,00	78,75	452
HTMV-125-4T/6-40 IE3	1776		55,9	30	117450	86,10	80,85	497
HTMV-125-4T/6-50 IE3	1776		69,2	37	131050	87,15	81,90	537
HTMV-125-4T/9-25 IE3	1764		33,6	18,5	79650	81,90	76,65	446
HTMV-125-4T/9-30 IE3	1770		40,6	22	88300	82,95	77,70	461
HTMV-125-4T/9-40 IE3	1776		55,9	30	104050	85,05	79,80	506
HTMV-125-4T/9-50 IE3	1776		69,2	37	118400	87,15	81,90	546
HTMV-125-6T/3-4 IE3	1164	12	6,91	3	46750	73,50	68,25	280
HTMV-125-6T/3-5.5 IE3	1152	15,6	8,99	4	55400	73,50	69,30	273
HTMV-125-6T/3-7.5 IE3	1164		11,2	5,5	68400	74,55	70,35	251
HTMV-125-6T/3-10 IE3	1164		14,8	7,5	79150	76,65	72,45	270
HTMV-125-6T/3-15 IE3	1164		22	11	87150	77,70	73,50	323
HTMV-125-6T/3-20 IE3	1170		28	15	91650	78,75	74,55	429
HTMV-125-6T/6-5.5 IE3	1152	15,6	8,99	4	51500	69,3	65,10	282
HTMV-125-6T/6-7.5 IE3	1164		11,2	5,5	60650	69,30	65,10	260
HTMV-125-6T/6-10 IE3	1164		14,8	7,5	72650	71,40	67,20	279
HTMV-125-6T/6-15 IE3	1164		22	11	85850	73,50	69,30	332
HTMV-125-6T/6-20 IE3	1170		28	15	92850	74,55	70,35	438
HTMV-125-6T/9-10 IE3	1164		14,8	7,5	63500	71,40	67,20	288
HTMV-125-6T/9-15 IE3	1164		22	11	77550	74,55	70,35	341
HTMV-125-6T/9-20 IE3	1170		28	15	92950	77,70	73,50	447

(1) Los valores de los niveles sonoros, son presiones en dB(A) medidos a 6 metros, en campo libre.

Accesorios



Curvas características

Q= Caudal en m³/h, m³/s y cfm.

Pe= Presión estática en mmH₂O, Pa e inwg.

40-4T

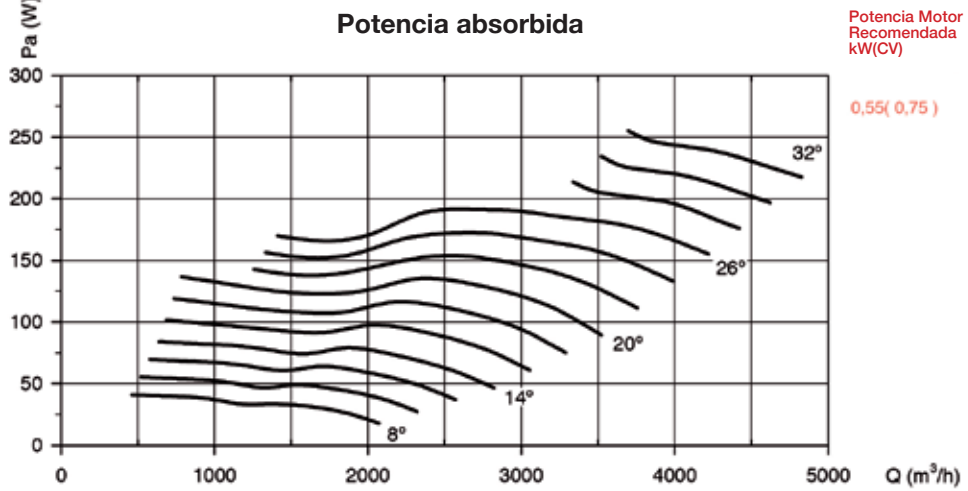
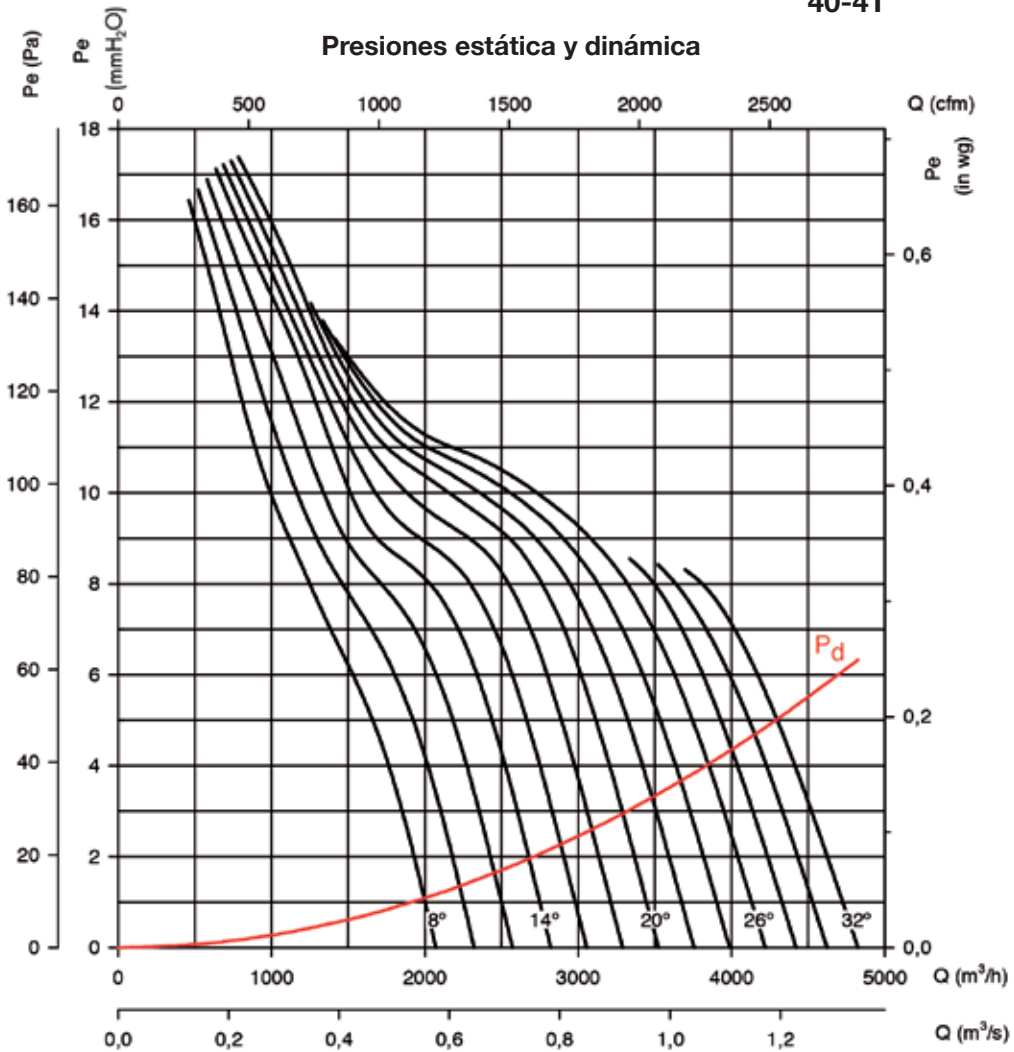

Curvas características

Q= Caudal en m³/h, m³/s y cfm.

Pe= Presión estática en mmH₂O, Pa e inwg.

40-6T

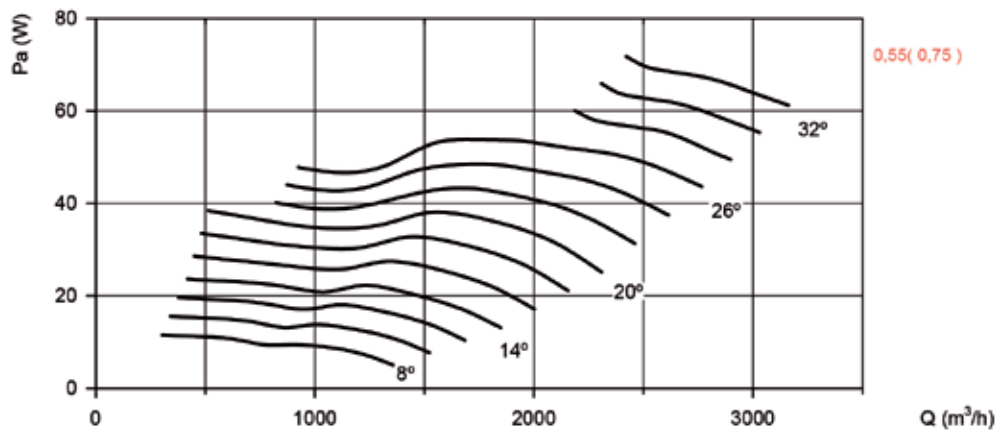
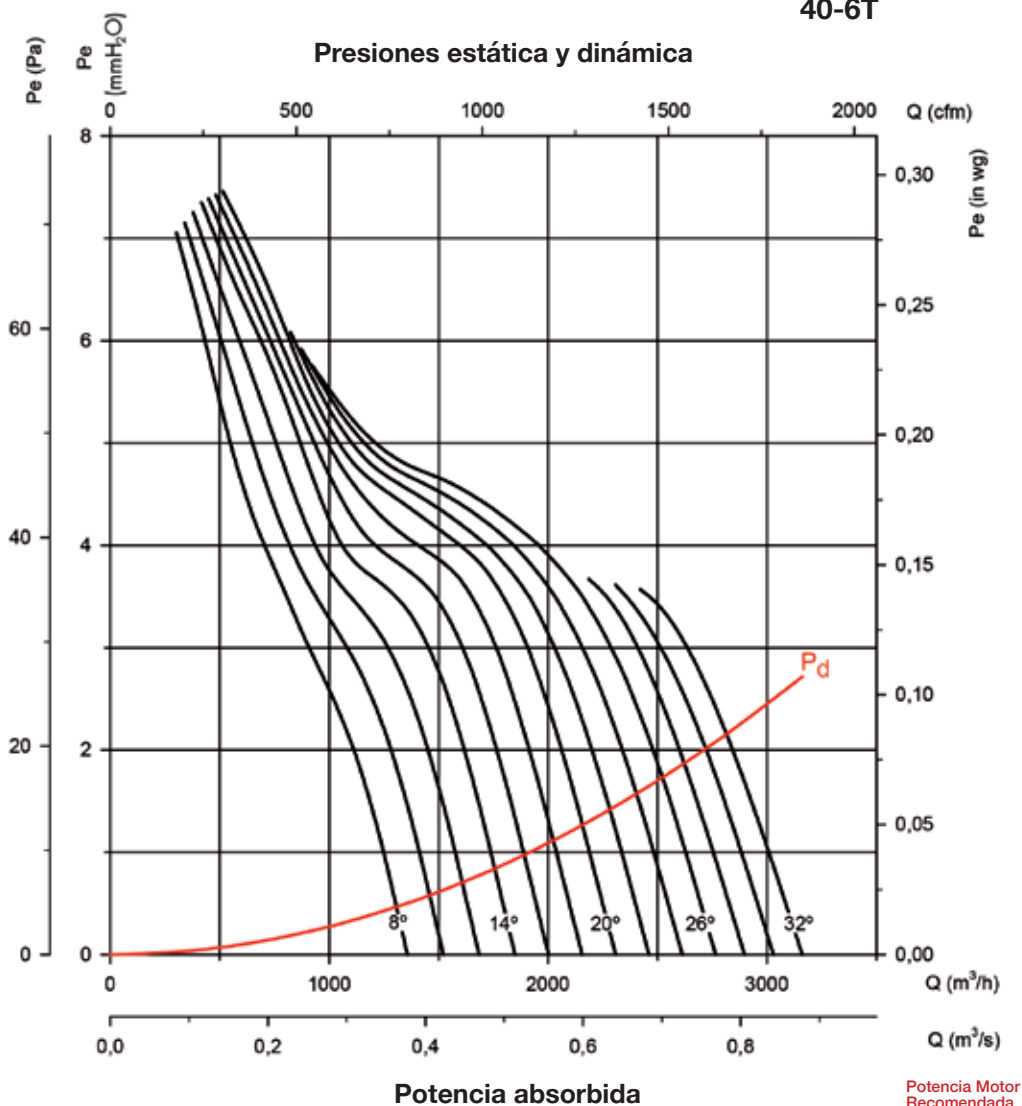

Curvas características

Q= Caudal en m³/h, m³/s y cfm.

Pe= Presión estática en mmH₂O, Pa e inwg.

45-4T

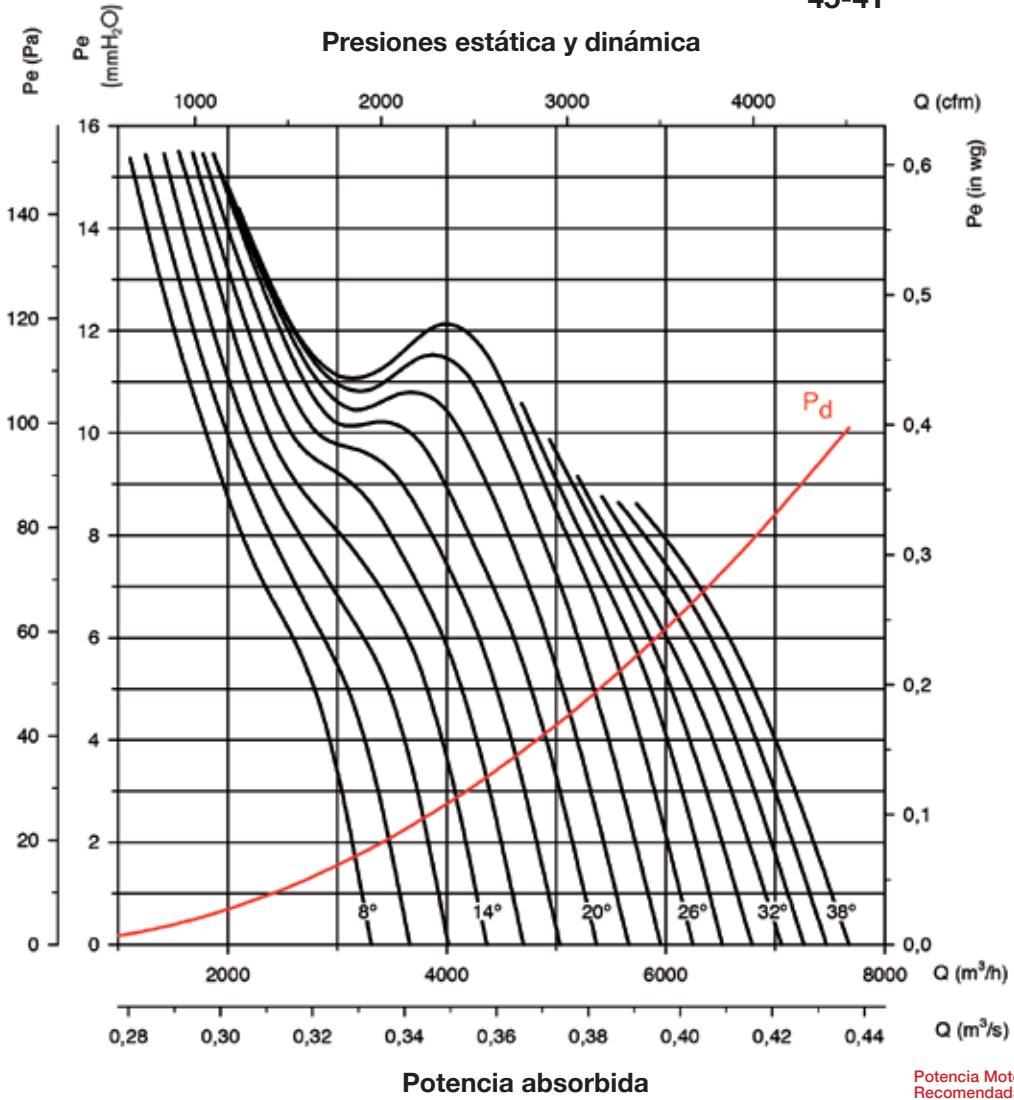

Potencia absorbida

Potencia Motor Recomendada kW(CV)

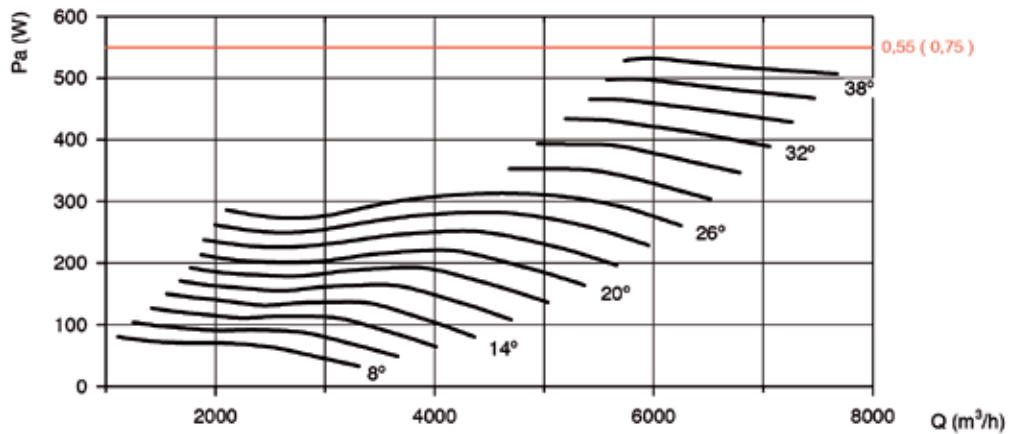

Curvas características

Q= Caudal en m³/h, m³/s y cfm.

Pe= Presión estática en mmH₂O, Pa e inwg.

45-6T

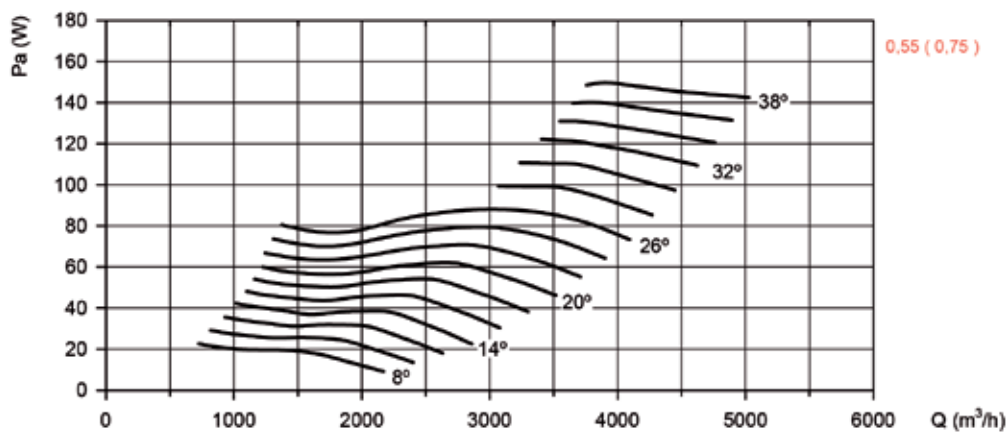
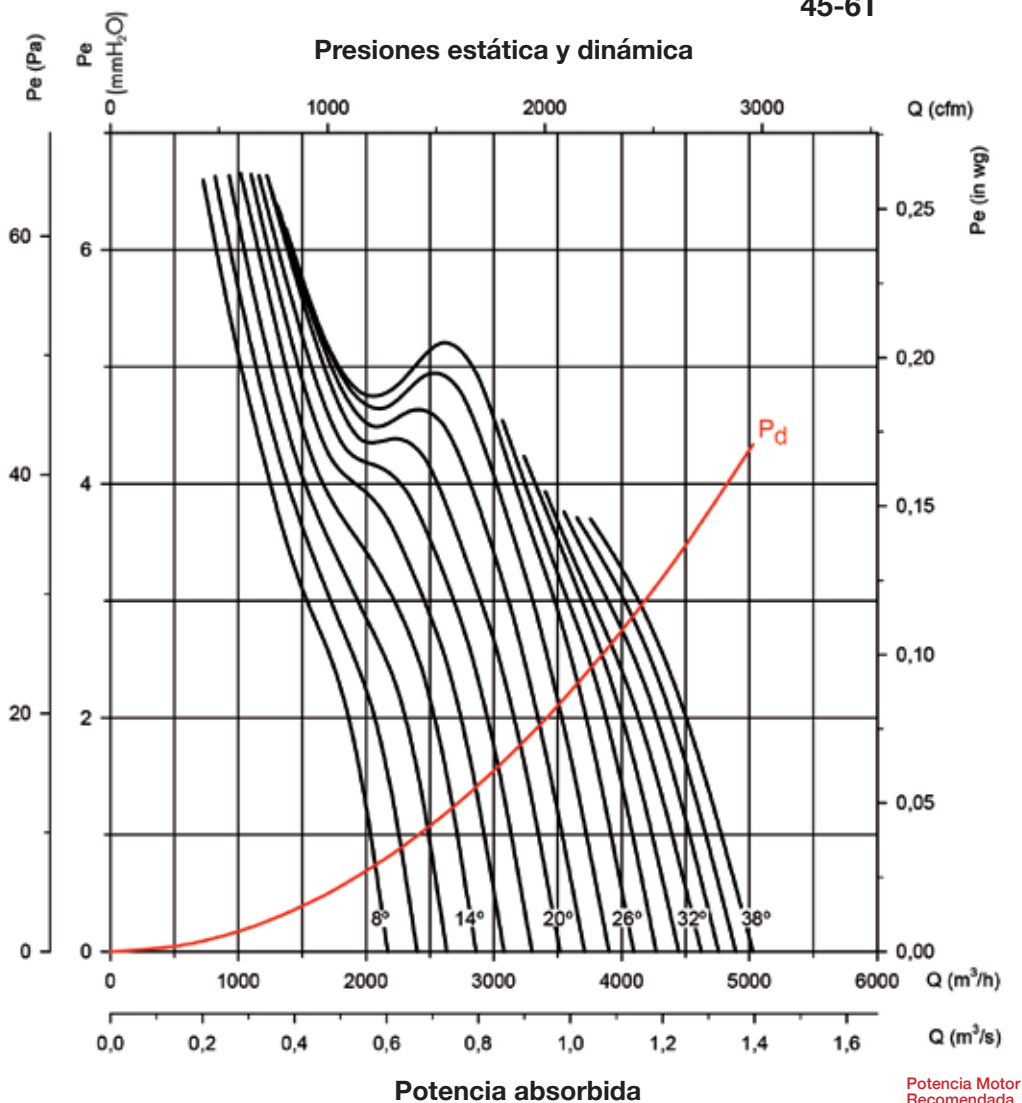

Curvas características

Q= Caudal en m³/h, m³/s y cfm.

Pe= Presión estática en mmH₂O, Pa e inwg.

50-4T

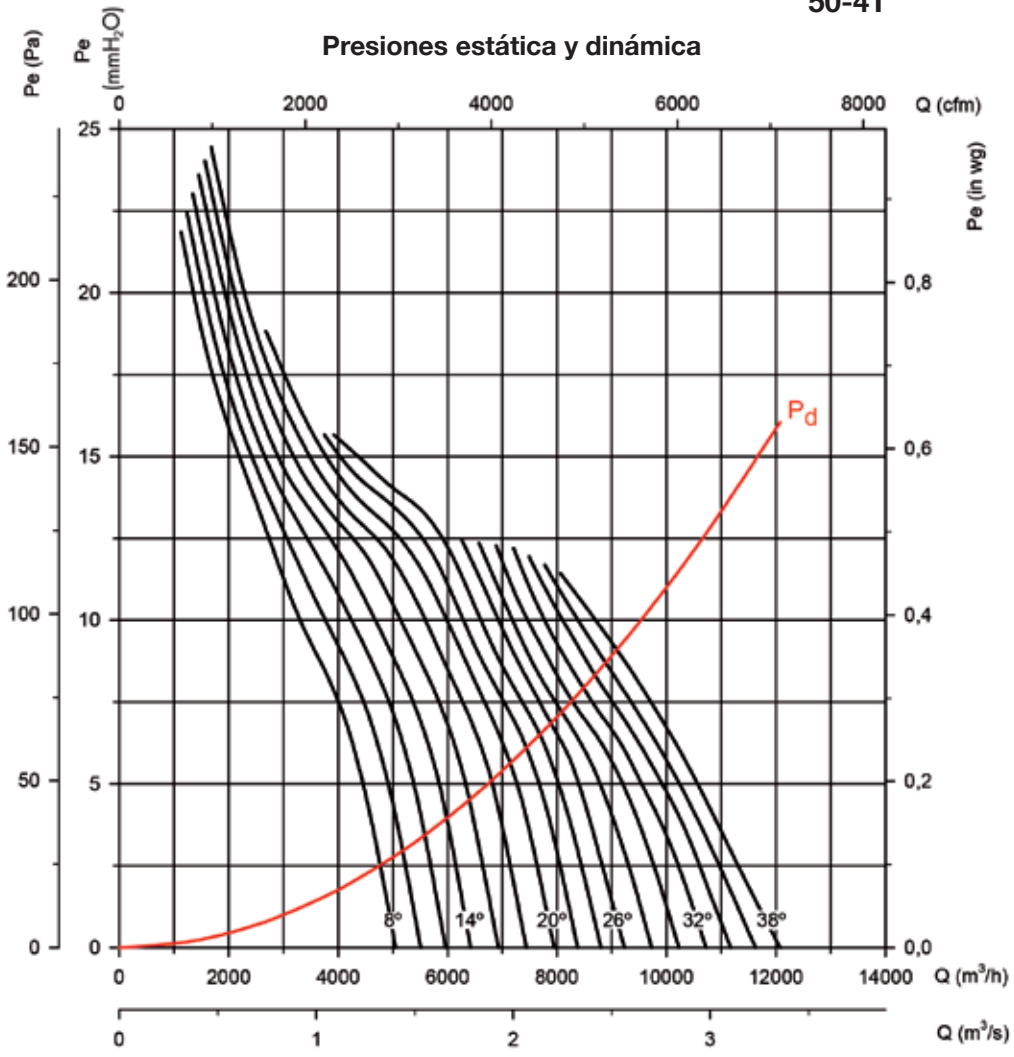

Potencia absorbida

Potencia Motor Recomendada kW(CV)

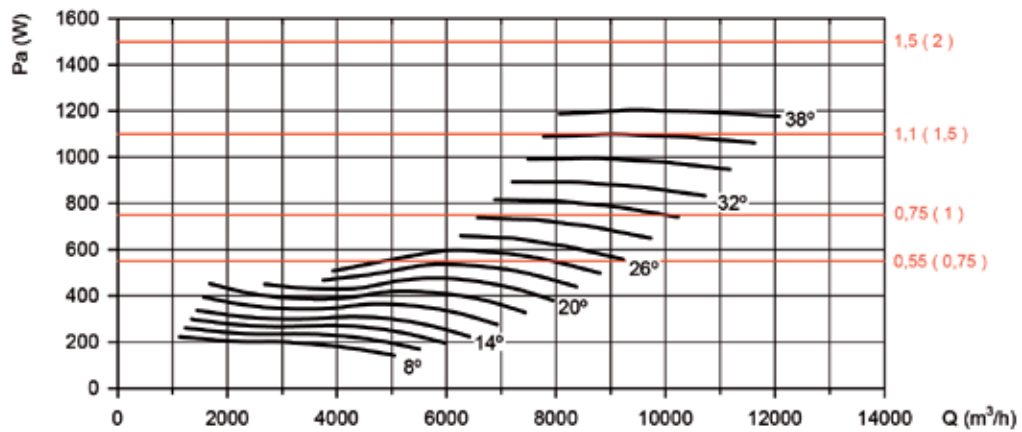

Curvas características

Q= Caudal en m³/h, m³/s y cfm.

Pe= Presión estática en mmH₂O, Pa e inwg.

50-6T

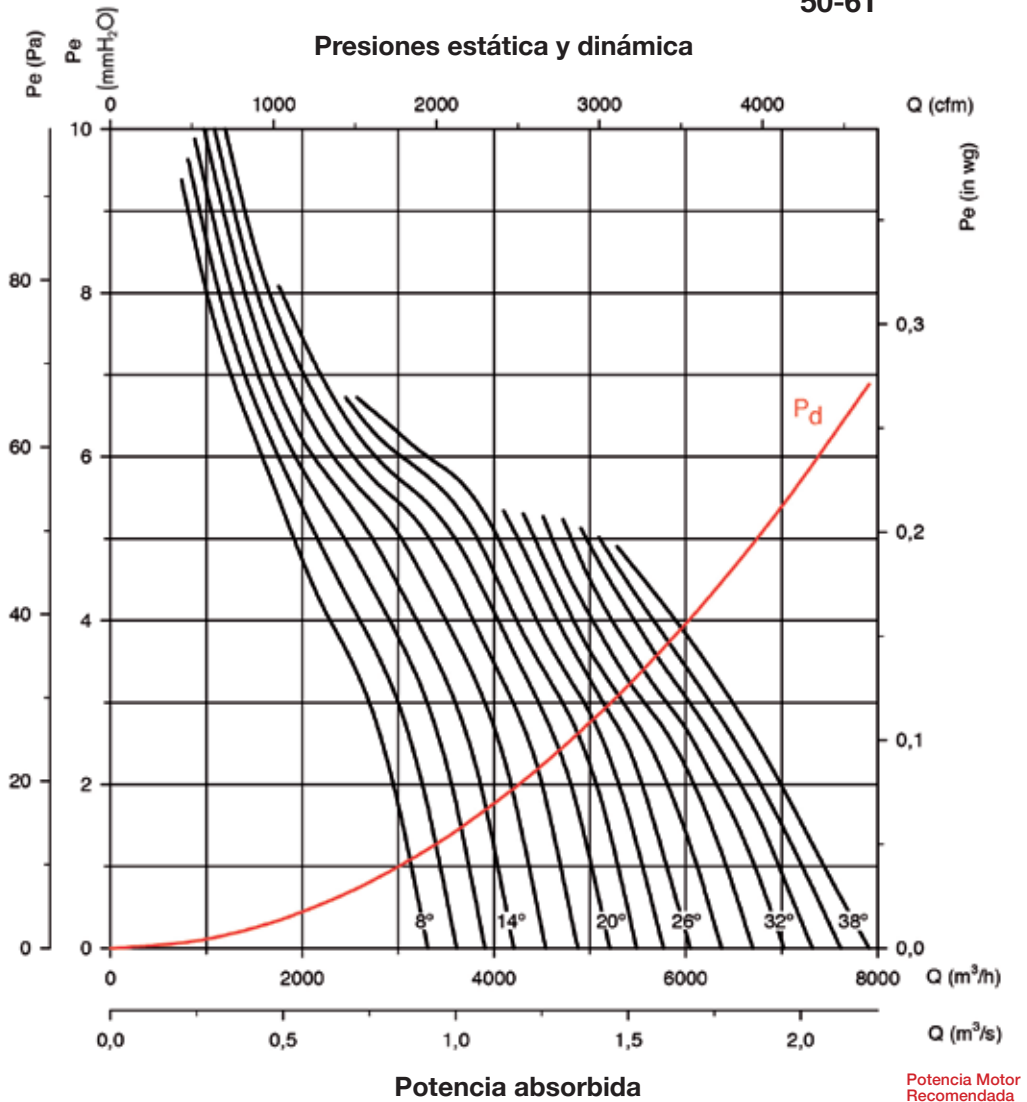

Potencia Motor Recomendada kW(CV)

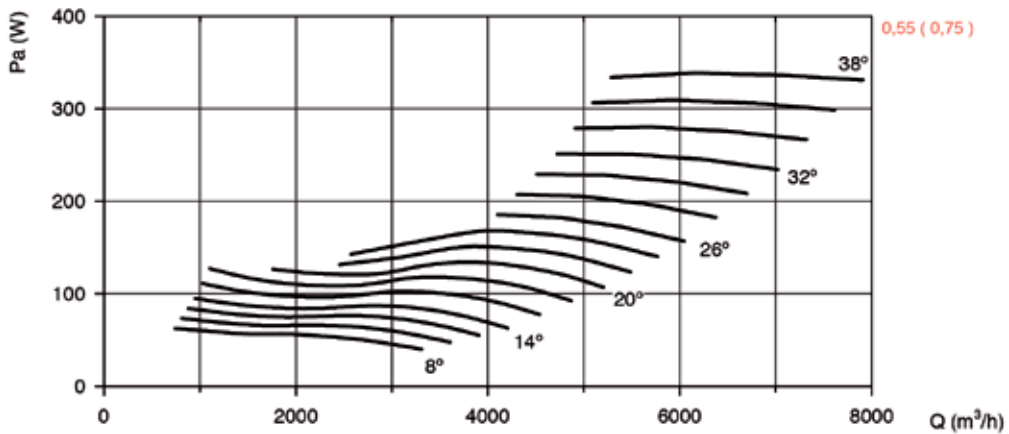

Curvas características

Q= Caudal en m³/h, m³/s y cfm.

Pe= Presión estática en mmH₂O, Pa e inwg.

56-4T

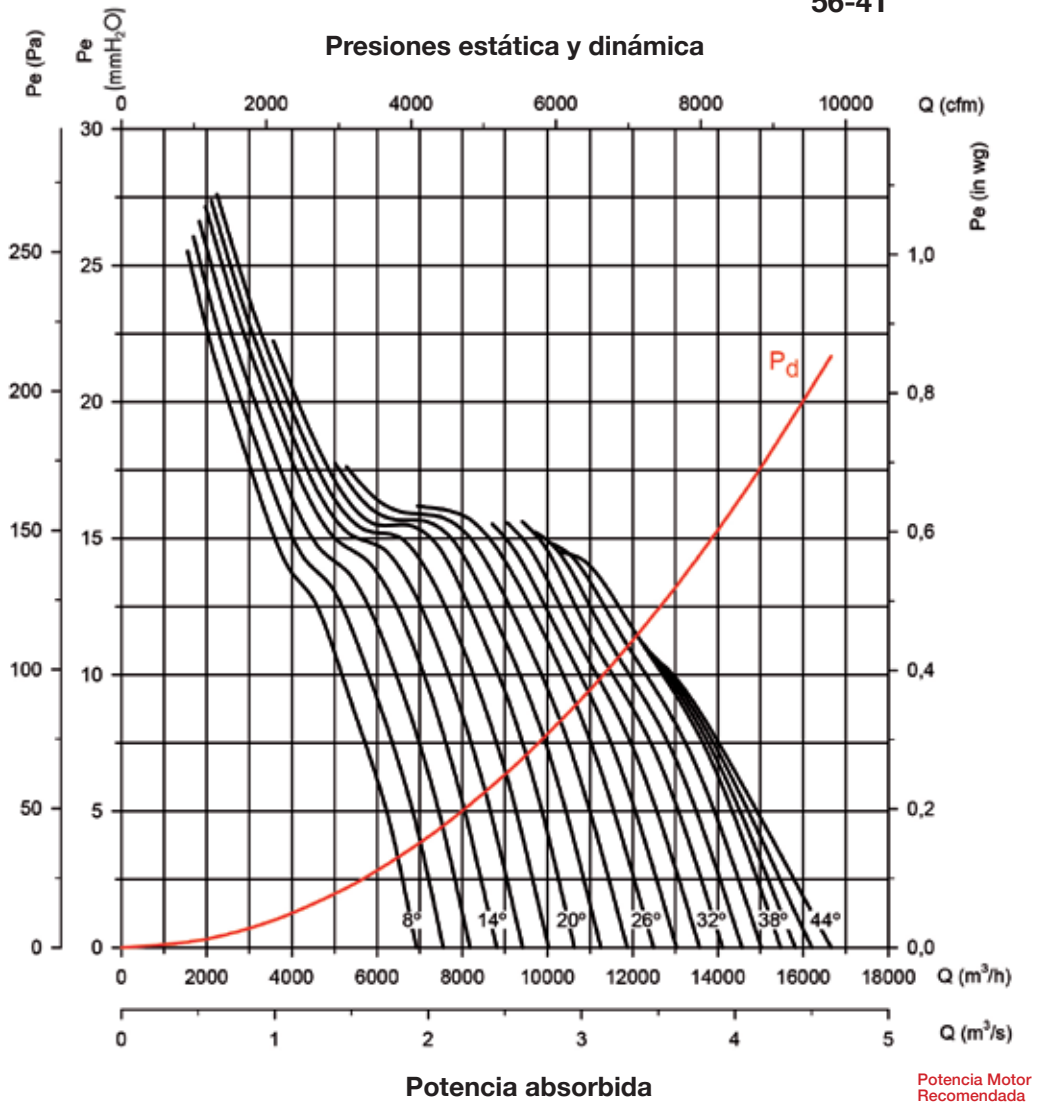

Potencia Motor Recomendada kW(CV)

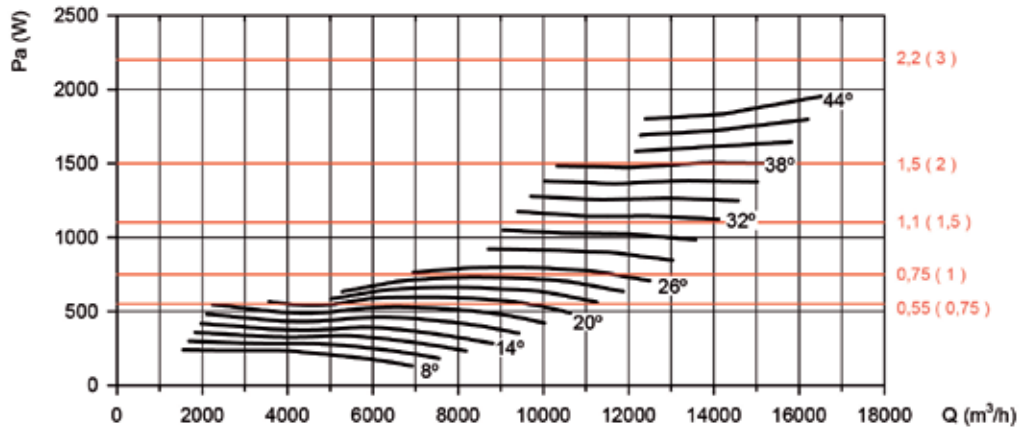

Curvas características

Q= Caudal en m³/h, m³/s y cfm.

Pe= Presión estática en mmH₂O, Pa e inwg.

56-6T

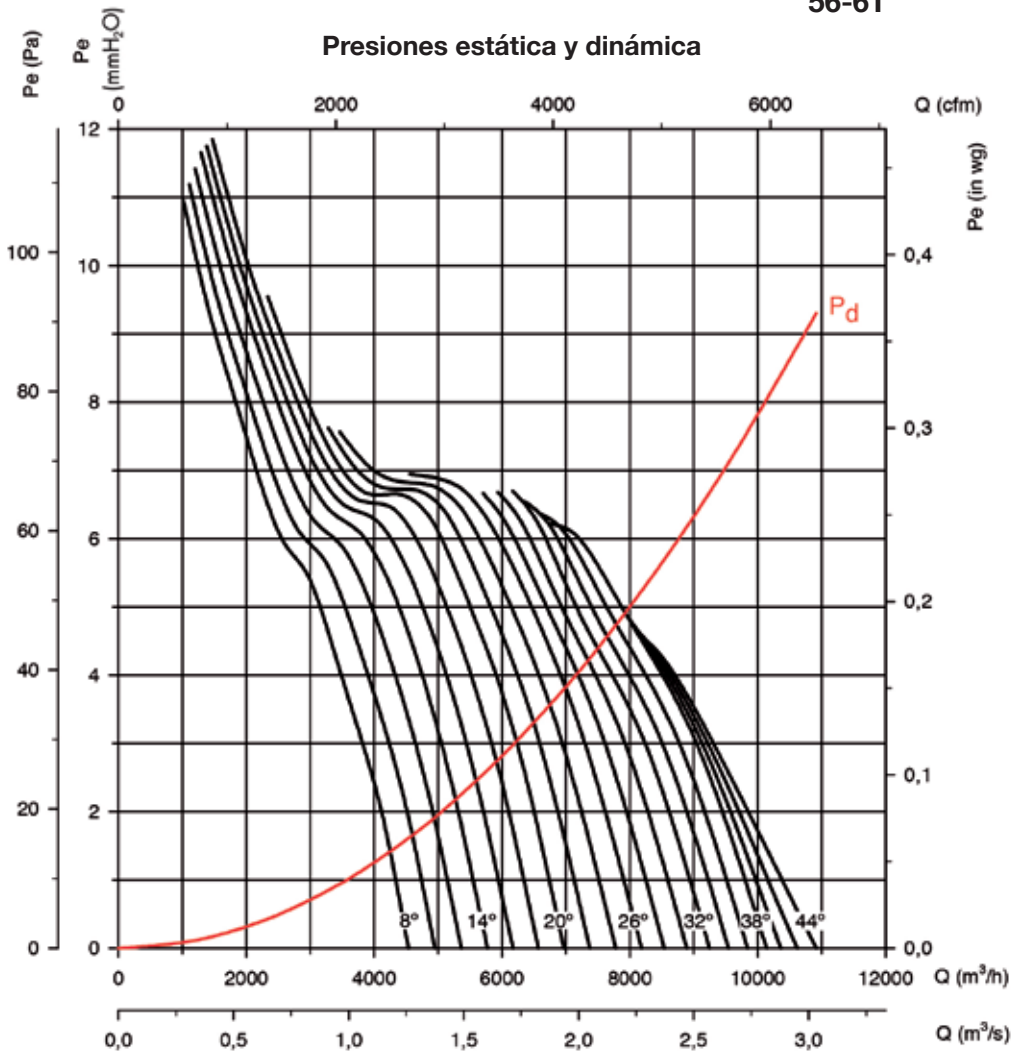

Potencia absorbida

Potencia Motor Recomendada kW(CV)

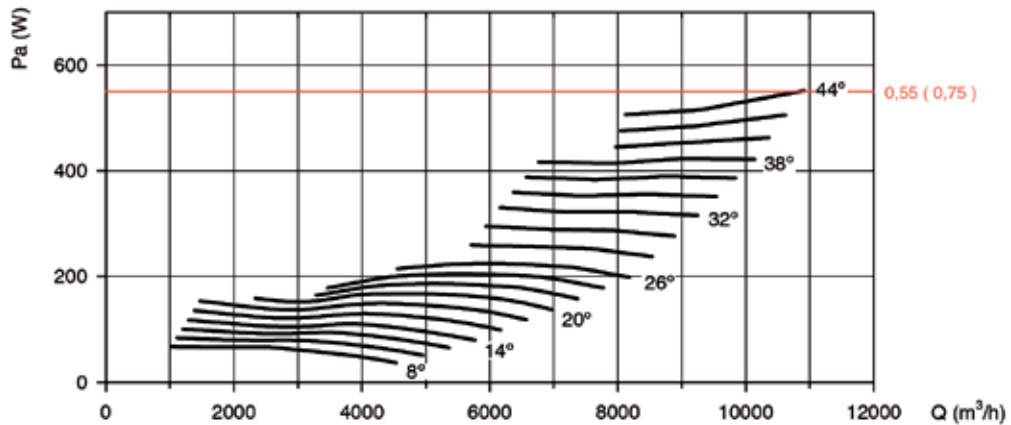

Curvas características

Q= Caudal en m³/h, m³/s y cfm.

Pe= Presión estática en mmH₂O, Pa e inwg.

63-4T

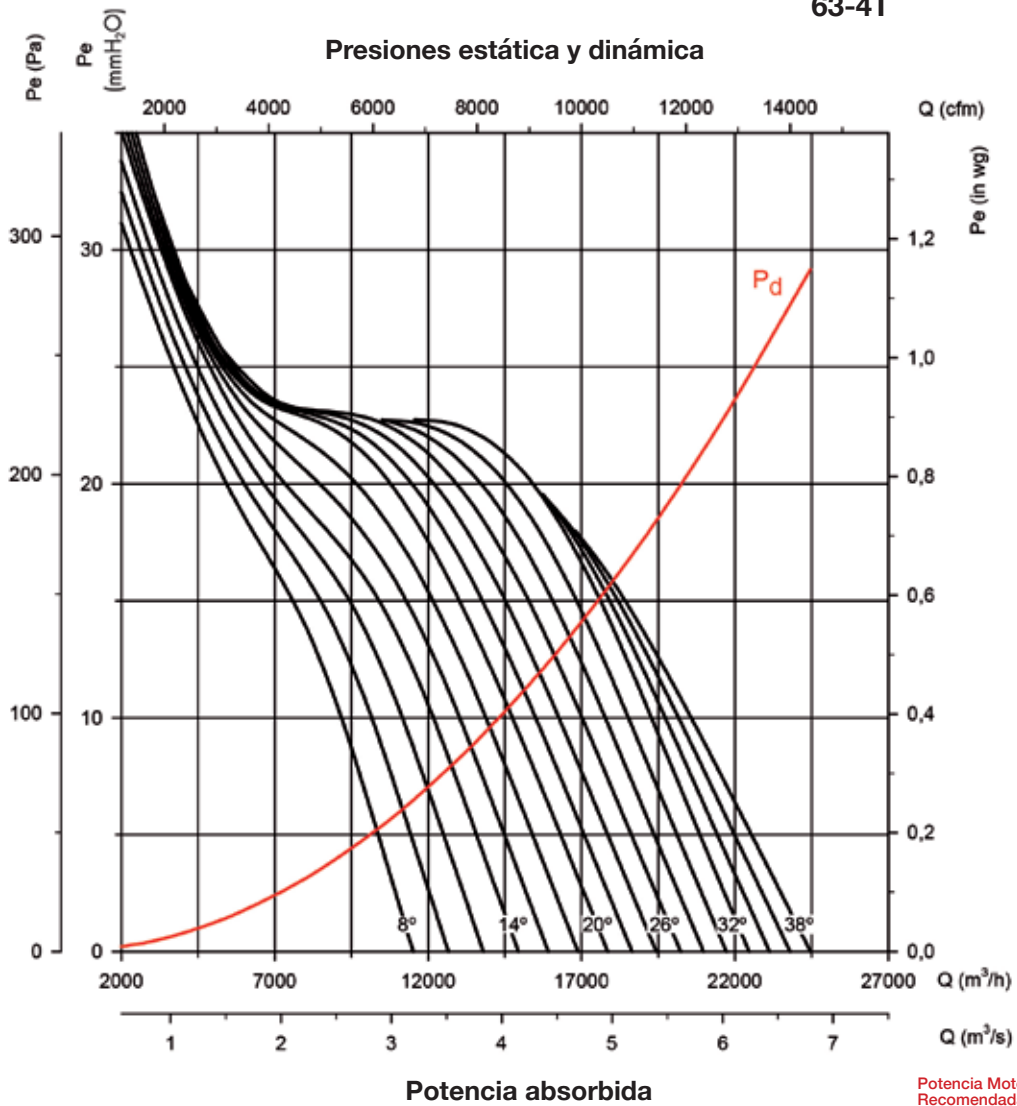

Potencia Motor Recomendada kW(CV)

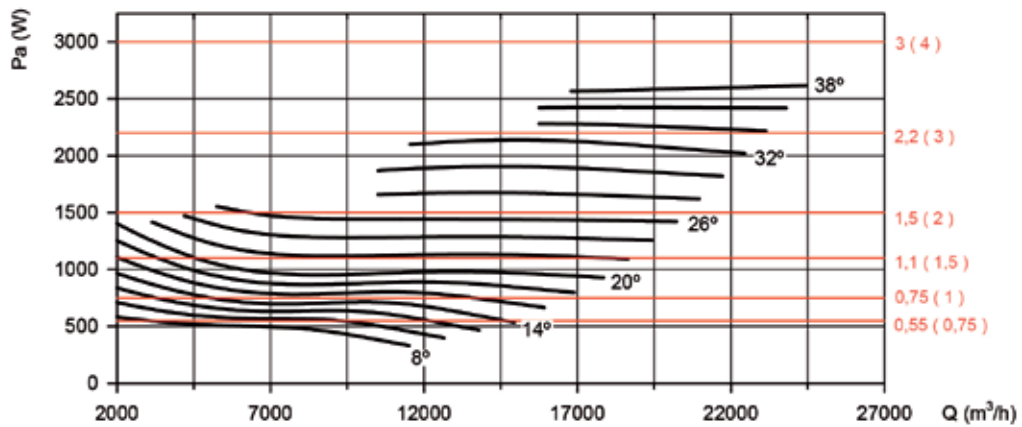

Curvas características

Q= Caudal en m³/h, m³/s y cfm.

Pe= Presión estática en mmH₂O, Pa e inwg.

63-6T

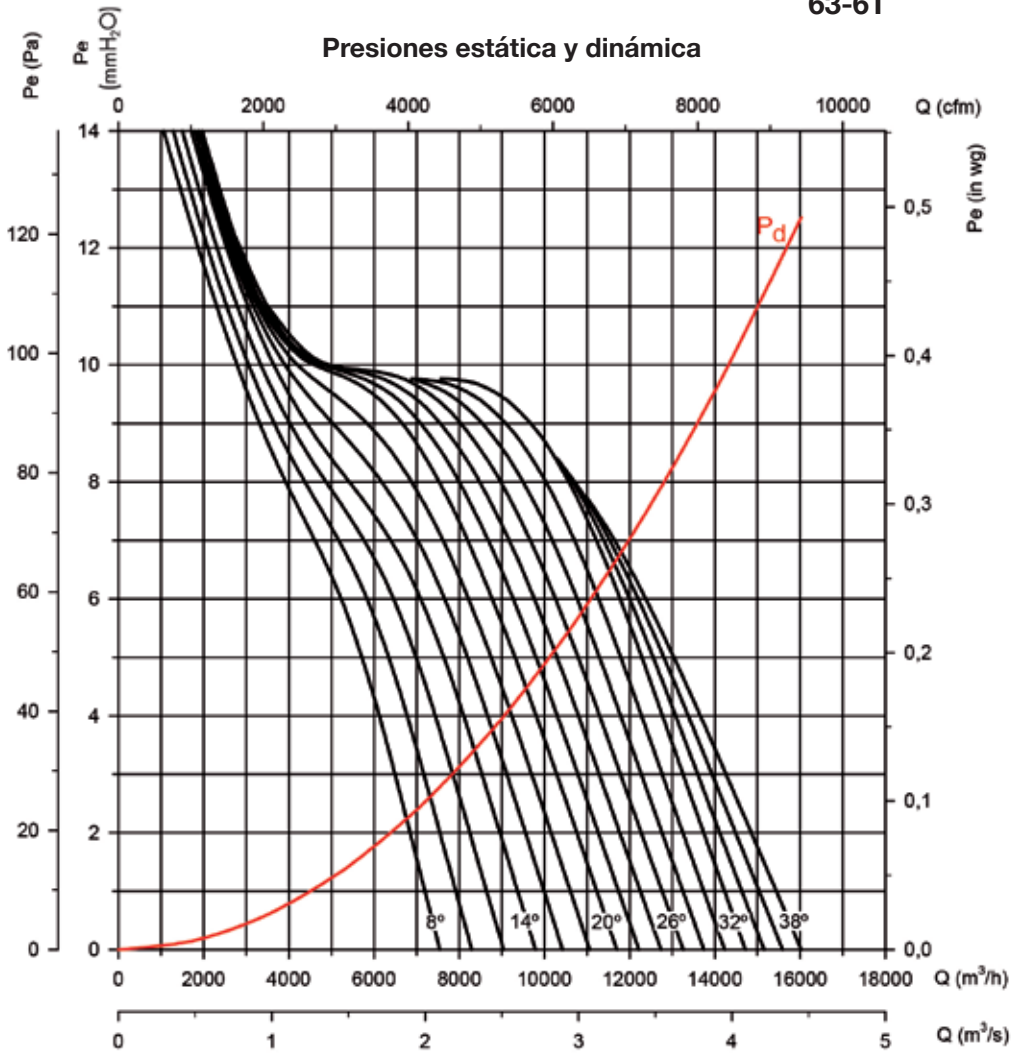

Potencia absorbida

Potencia Motor Recomendada kW(CV)

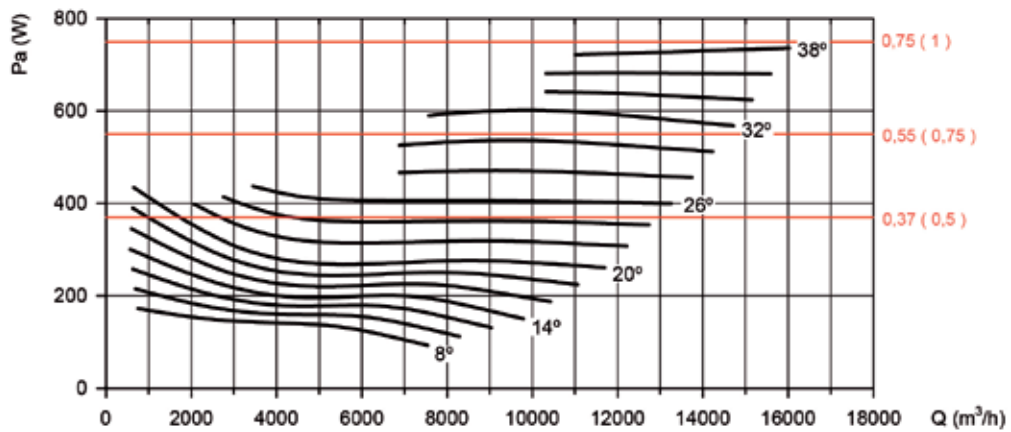

Curvas características

Q= Caudal en m³/h, m³/s y cfm.

Pe= Presión estática en mmH₂O, Pa e inwg.

71-4T

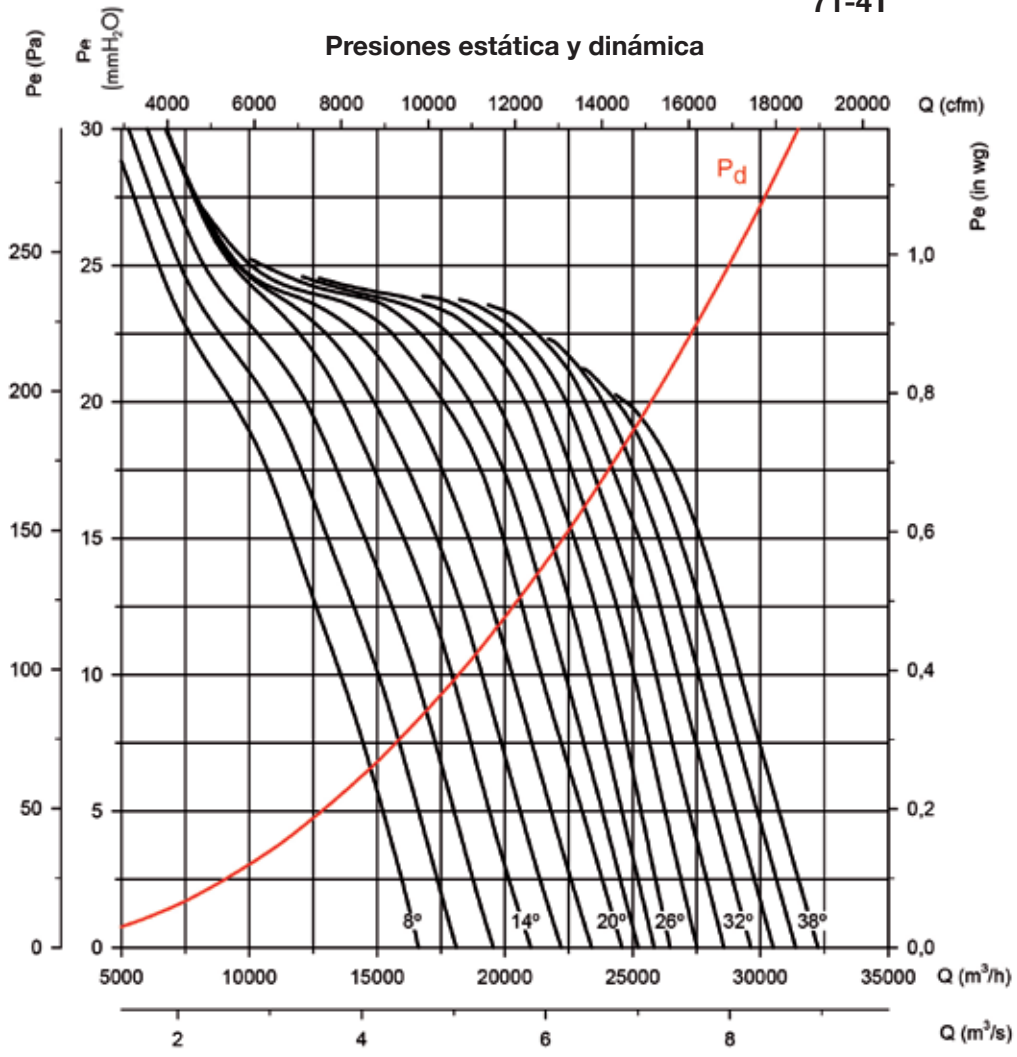

Potencia absorbida

Potencia Motor Recomendada kW(CV)

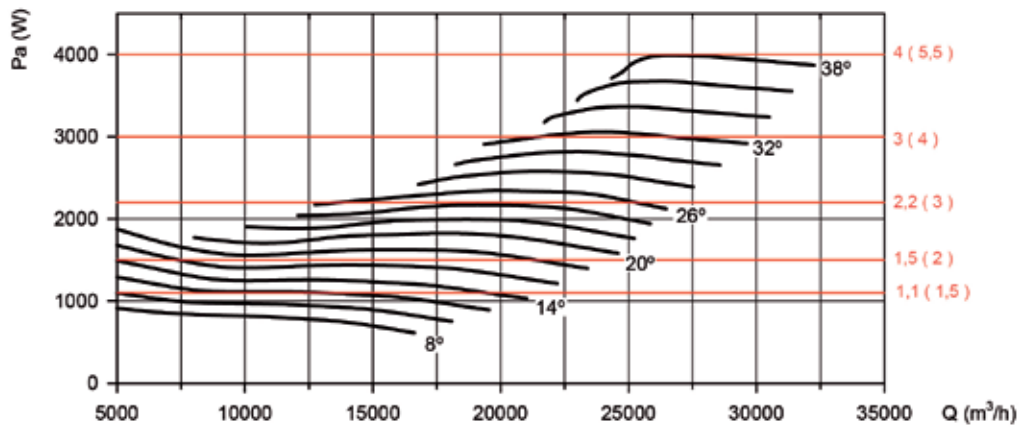

Curvas características

Q= Caudal en m³/h, m³/s y cfm.

Pe= Presión estática en mmH₂O, Pa e inwg.

71-6T

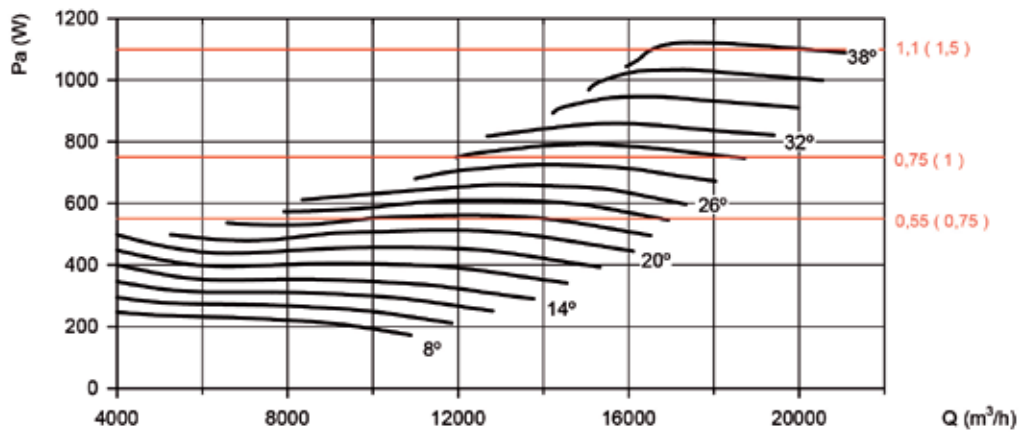
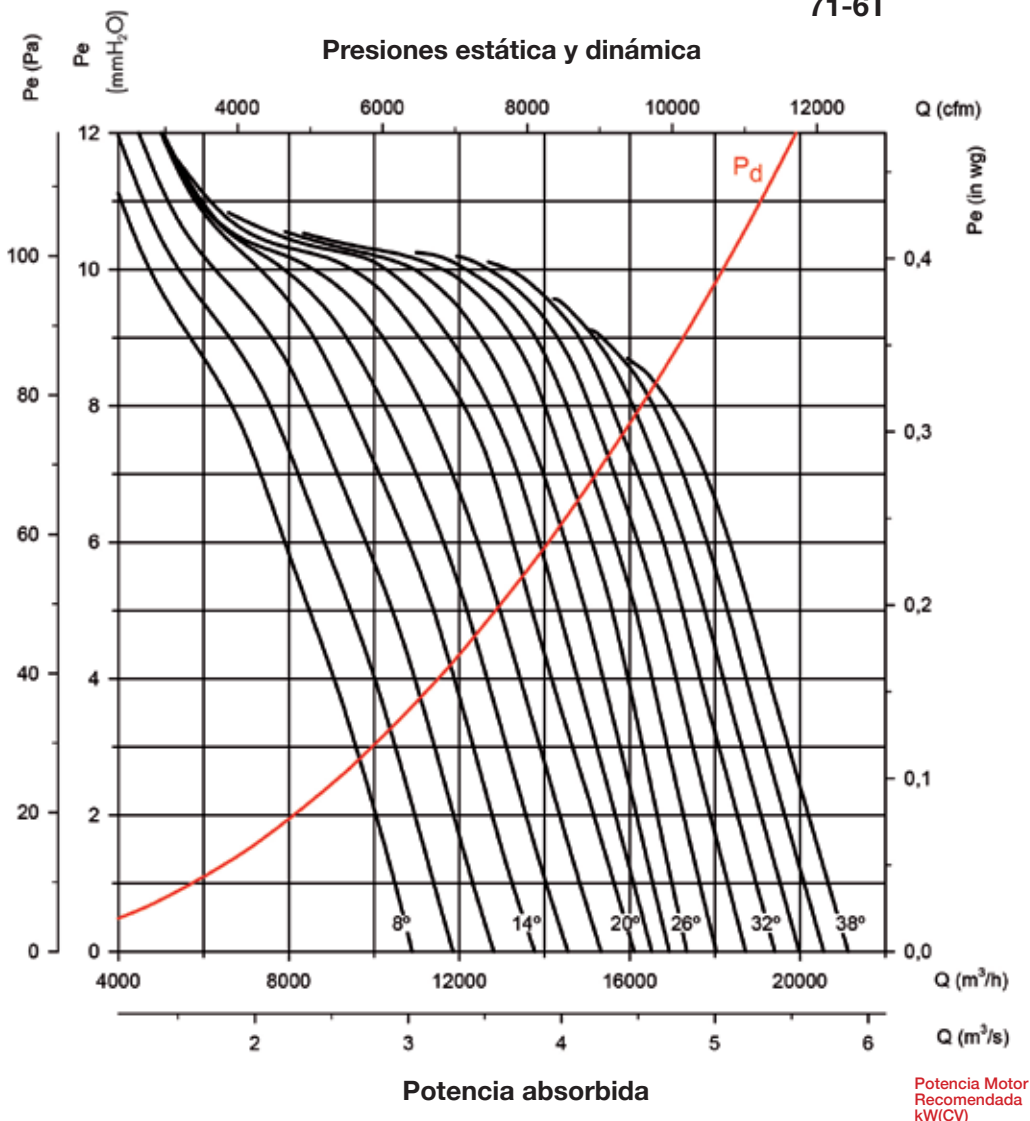

Curvas características

Q= Caudal en m³/h, m³/s y cfm.

Pe= Presión estática en mmH₂O, Pa e inwg.

80-4T

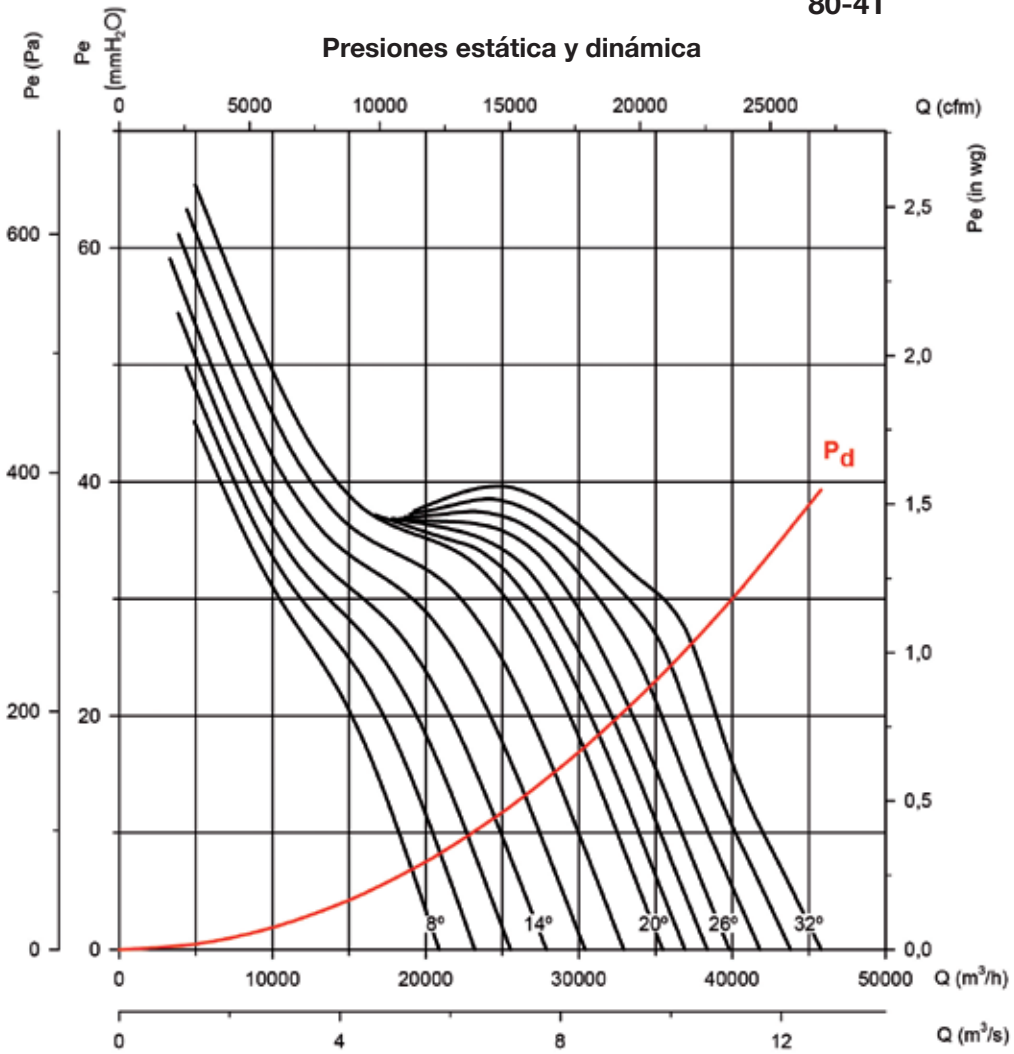

Potencia absorbida

Potencia Motor Recomendada kW(CV)

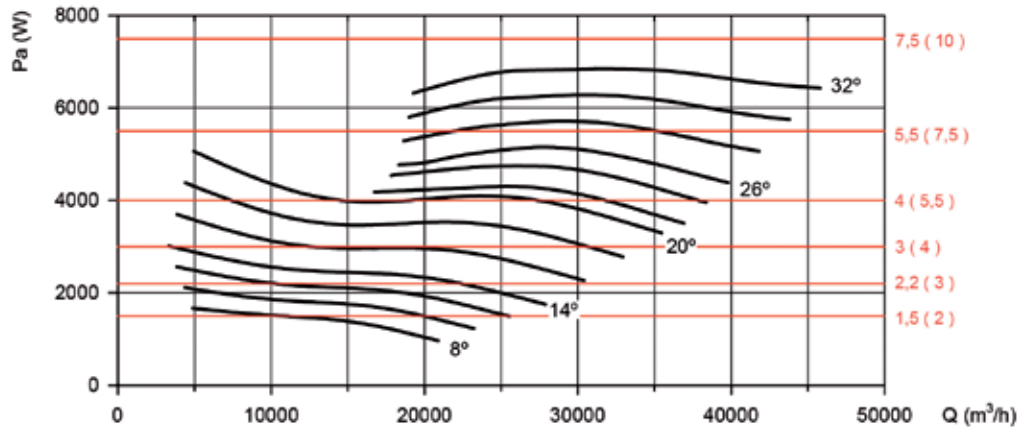

Curvas características

Q= Caudal en m³/h, m³/s y cfm.

Pe= Presión estática en mmH₂O, Pa e inwg.

80-6T

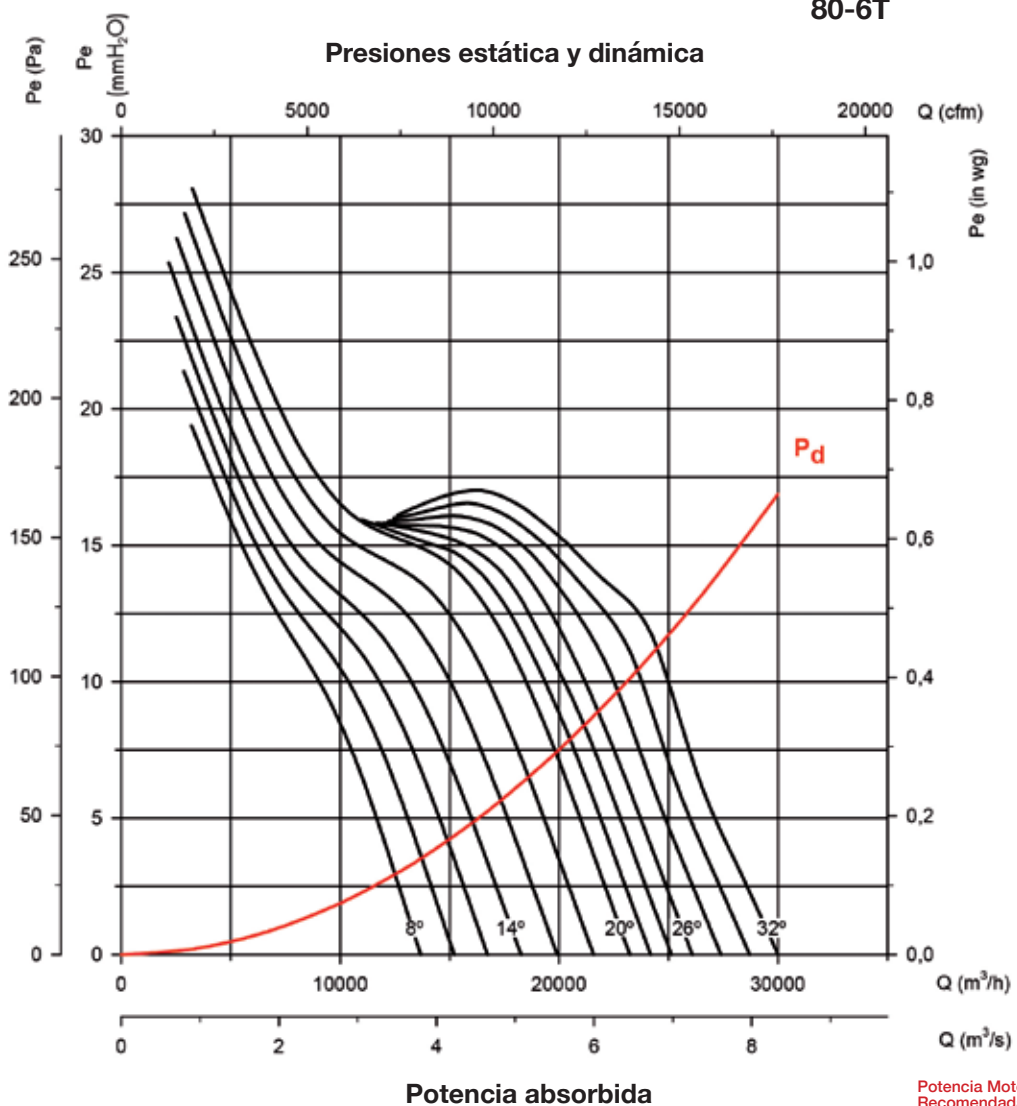

Potencia Motor Recomendada kW(CV)

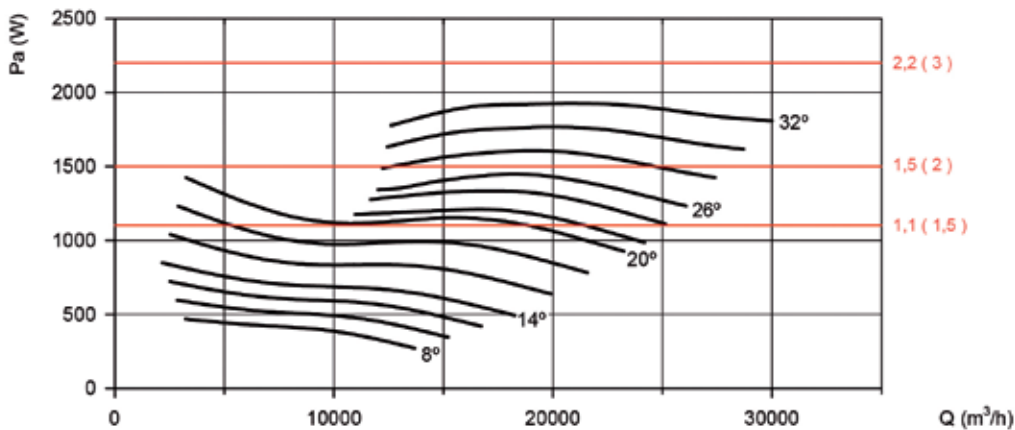

Curvas características

Q= Caudal en m³/h, m³/s y cfm.

Pe= Presión estática en mmH₂O, Pa e inwg.

90-4T

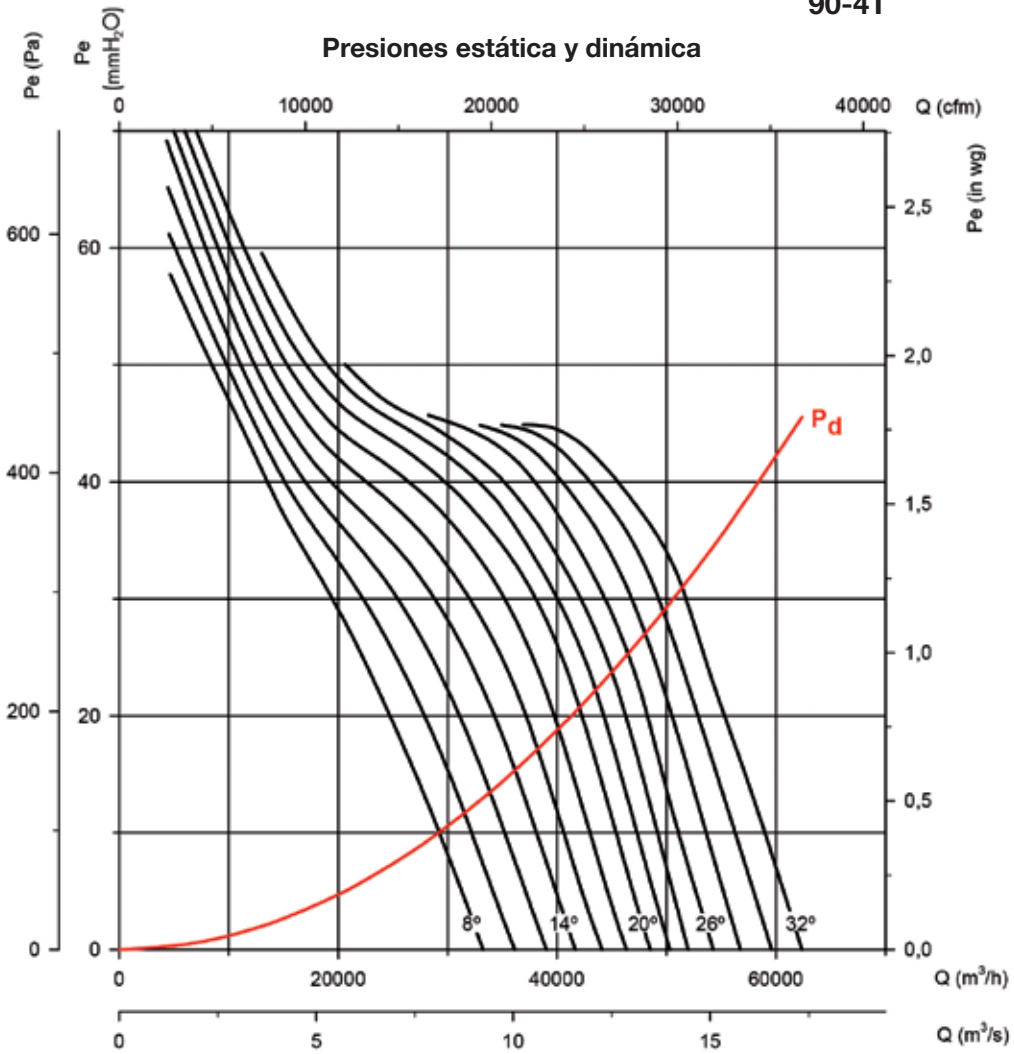

Potencia absorbida

Potencia Motor Recomendada kW(CV)

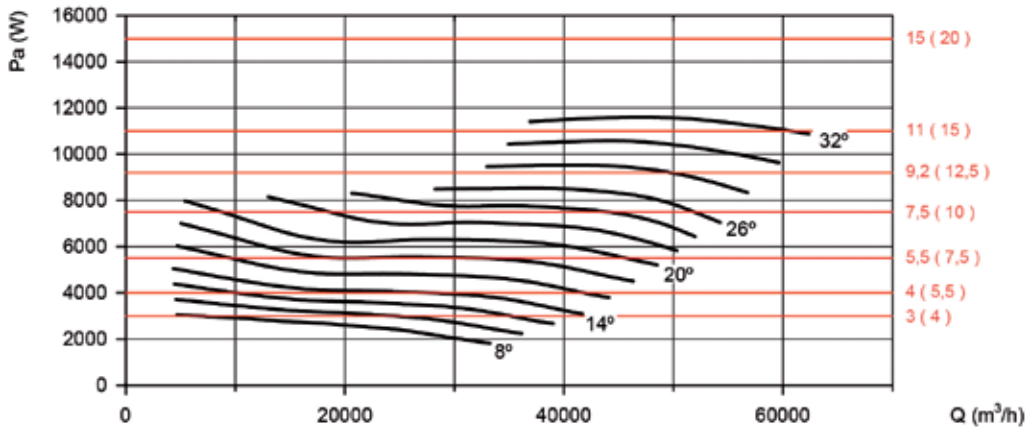

Curvas características

Q= Caudal en m³/h, m³/s y cfm.

Pe= Presión estática en mmH₂O, Pa e inwg.

90-6T

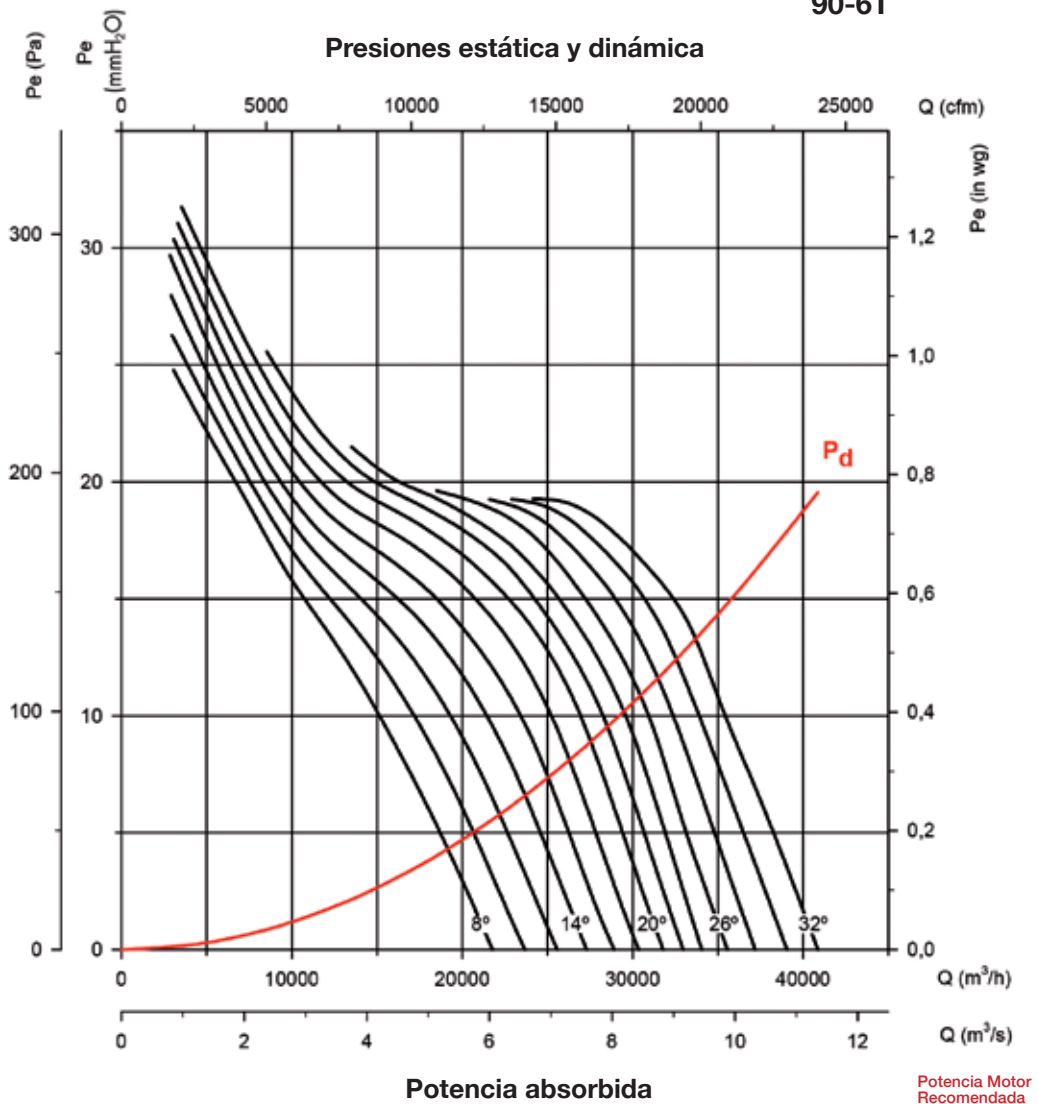

Potencia Motor Recomendada kW(CV)

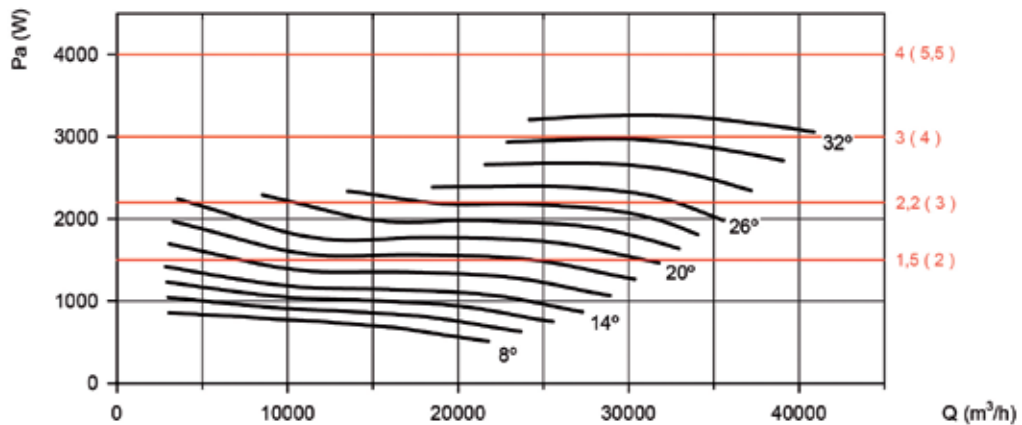

Curvas características

Q= Caudal en m³/h, m³/s y cfm.

Pe= Presión estática en mmH₂O, Pa e inwg.

100-4T/6

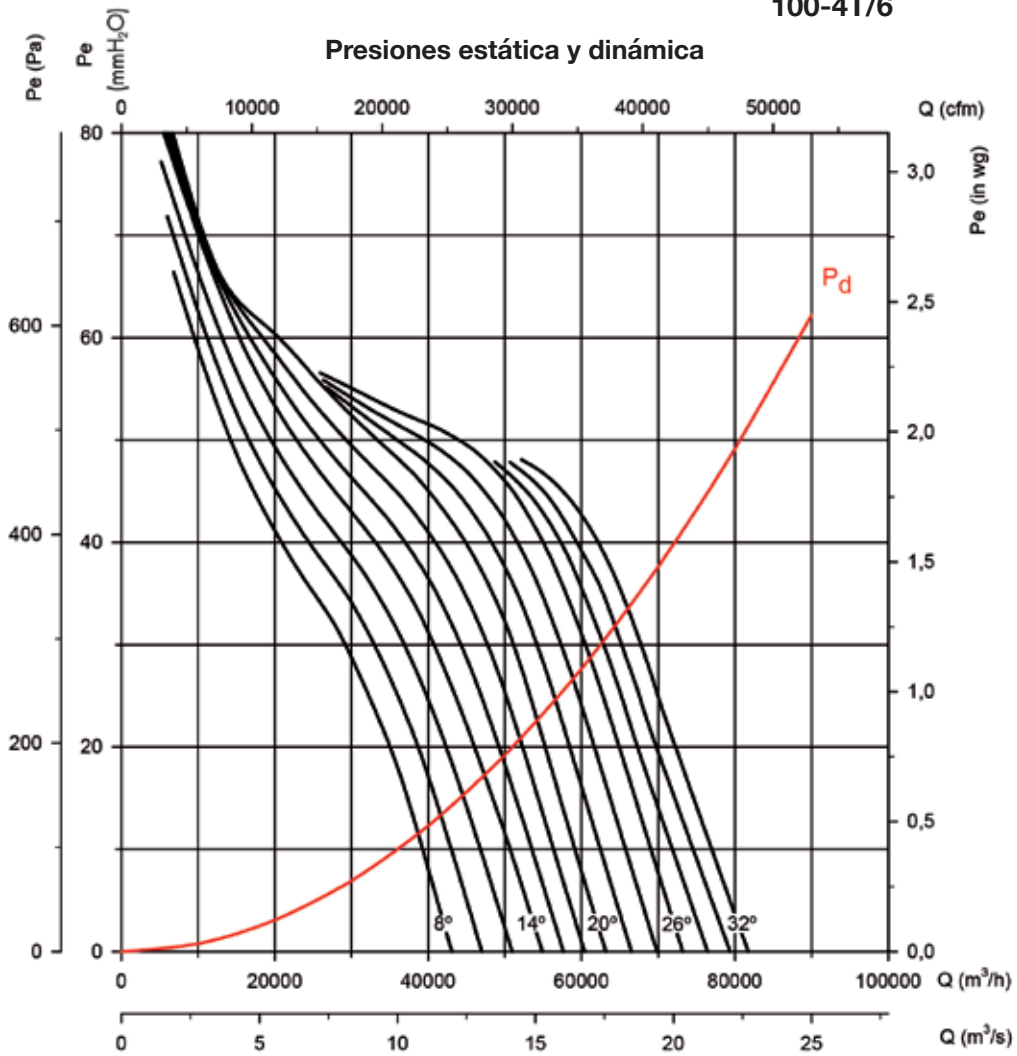

Potencia absorbida

Potencia Motor Recomendada kW(CV)

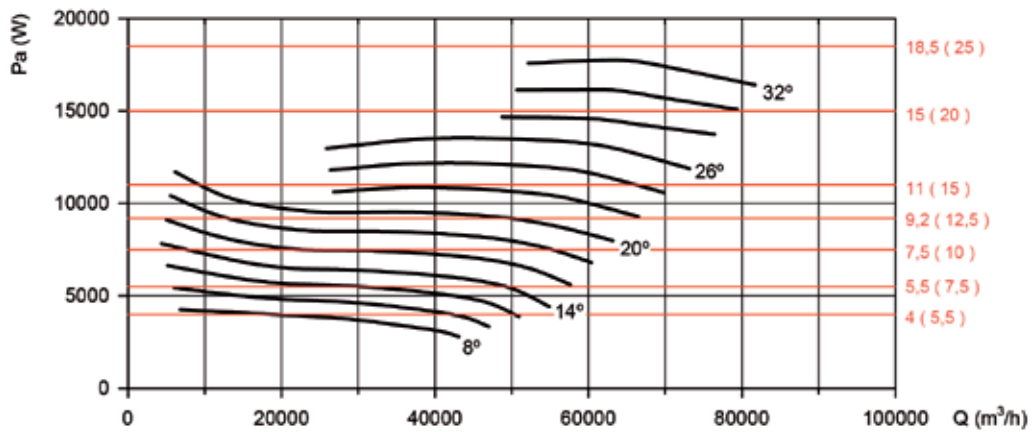

Curvas características

Q= Caudal en m³/h, m³/s y cfm.

Pe= Presión estática en mmH₂O, Pa e inwg.

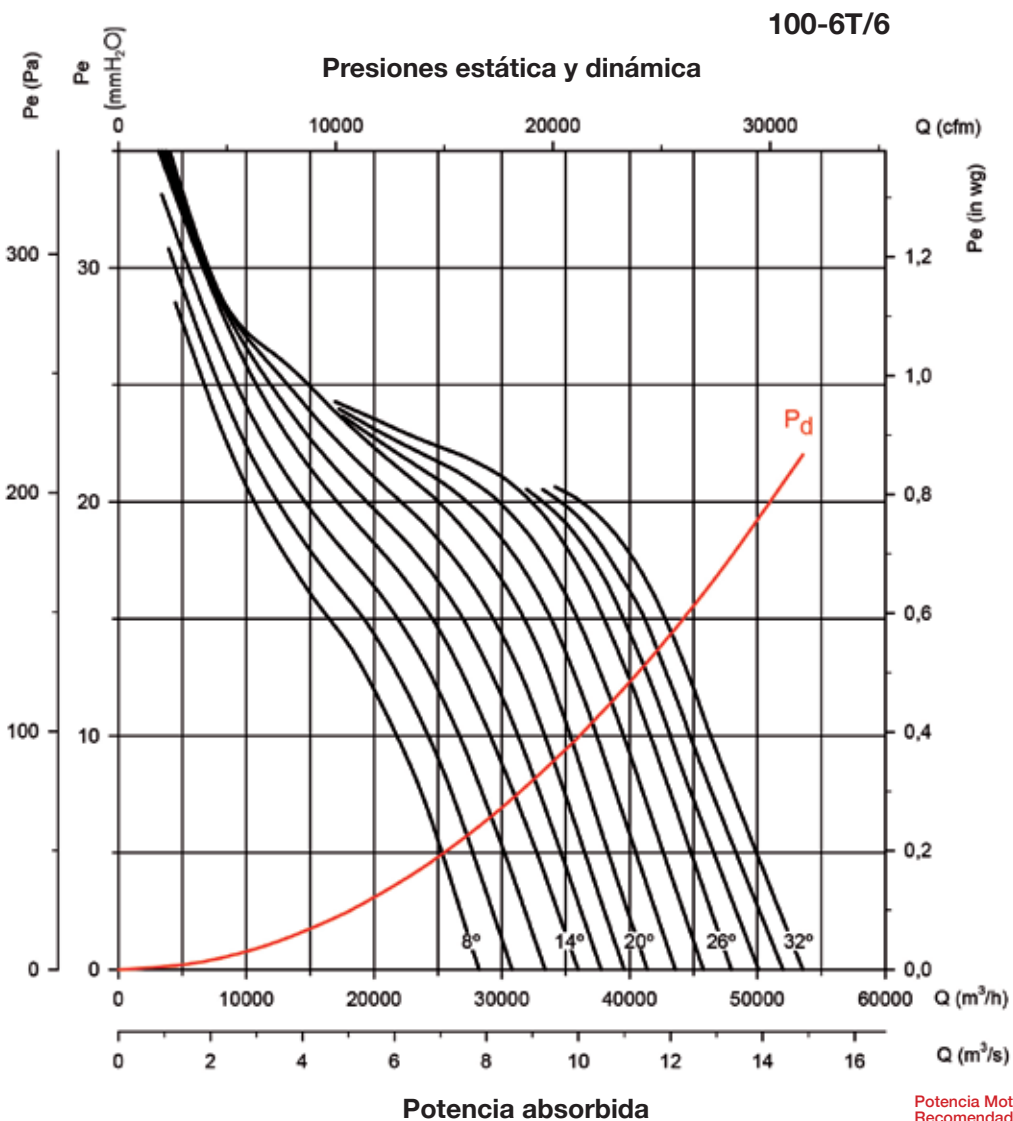

Potencia Motor
Recomendada
kW(CV)

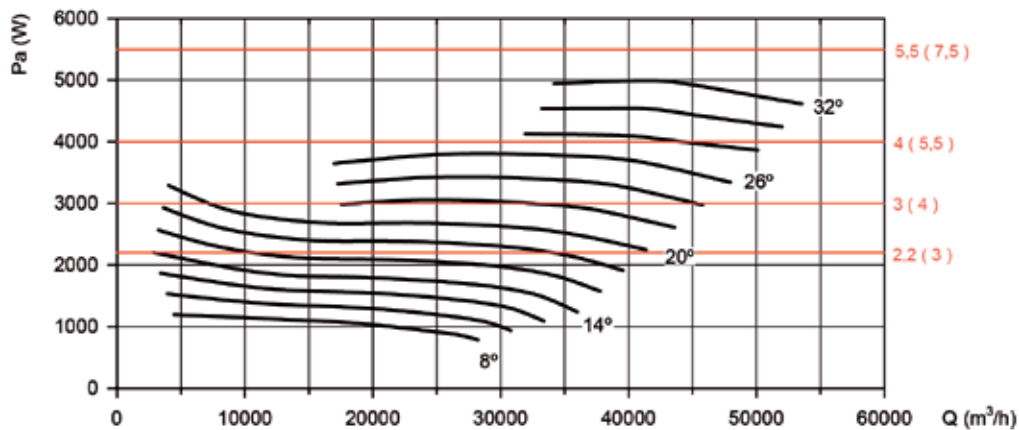

Curvas características

Q= Caudal en m³/h, m³/s y cfm.

Pe= Presión estática en mmH₂O, Pa e inwg.

125-4T/3

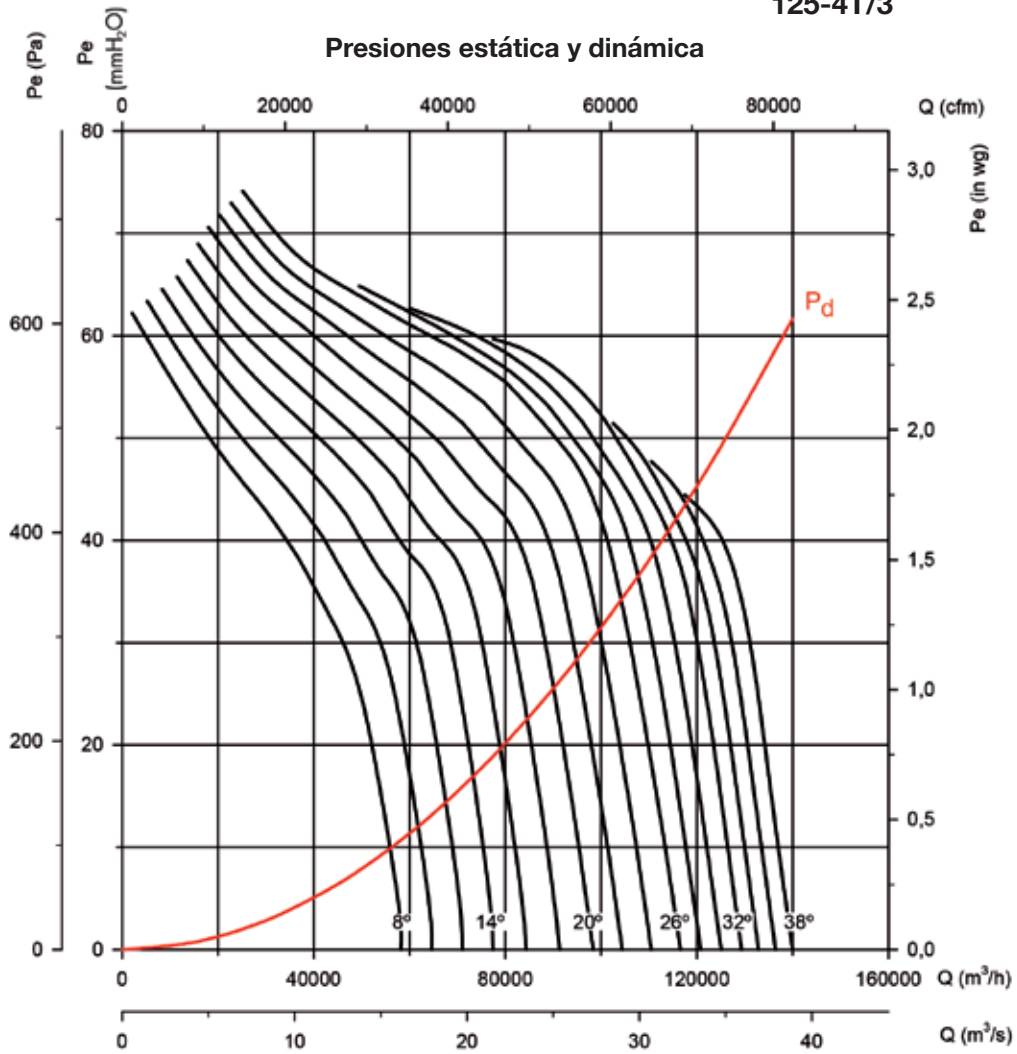

Potencia absorbida

Potencia Motor Recomendada kW(CV)

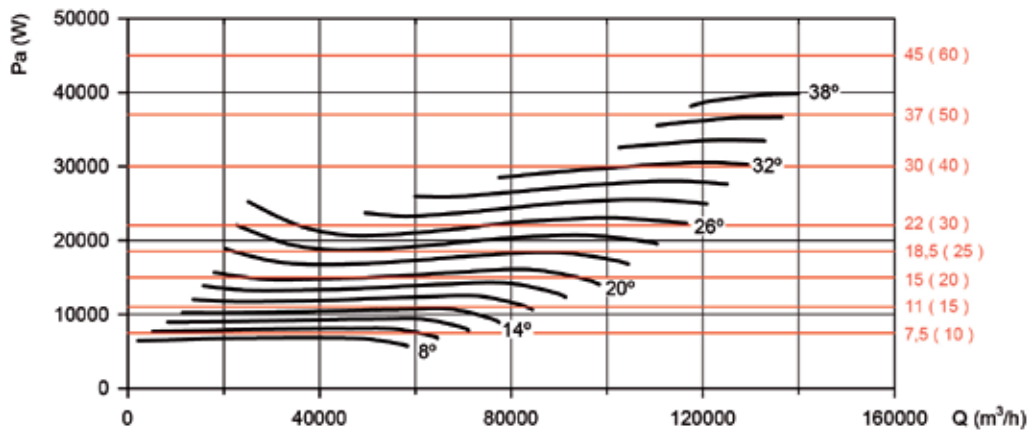

Curvas características

Q= Caudal en m³/h, m³/s y cfm.

Pe= Presión estática en mmH₂O, Pa e inwg.

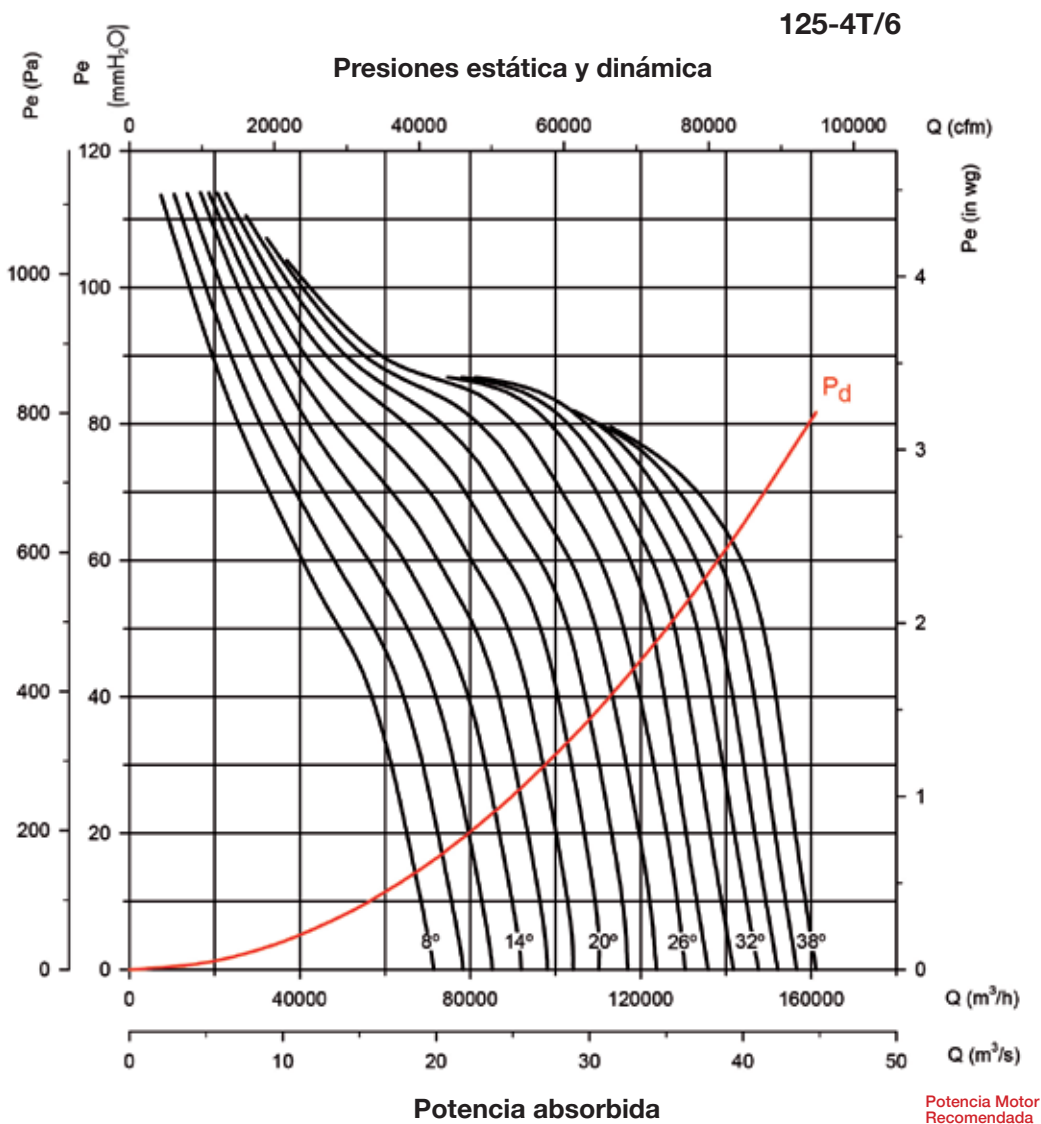

Potencia Motor Recomendada kW(CV)

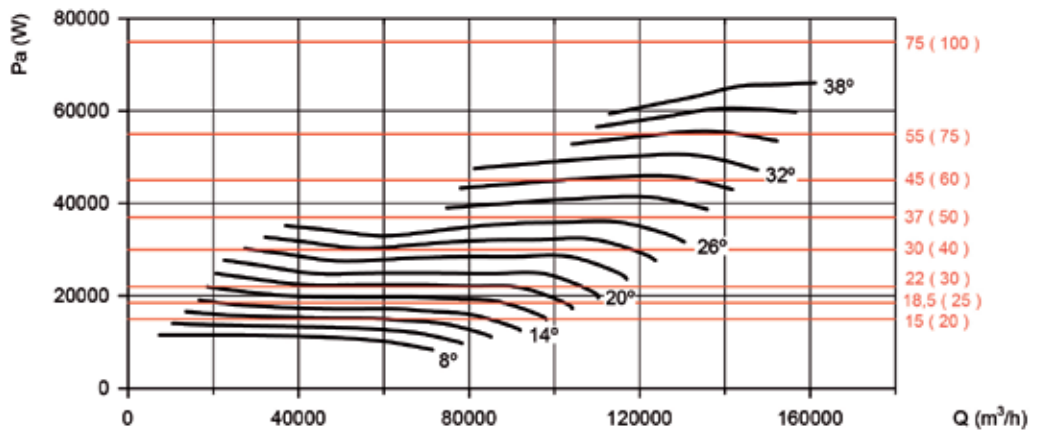

Curvas características

Q= Caudal en m³/h, m³/s y cfm.

Pe= Presión estática en mmH₂O, Pa e inwg.

125-4T/9

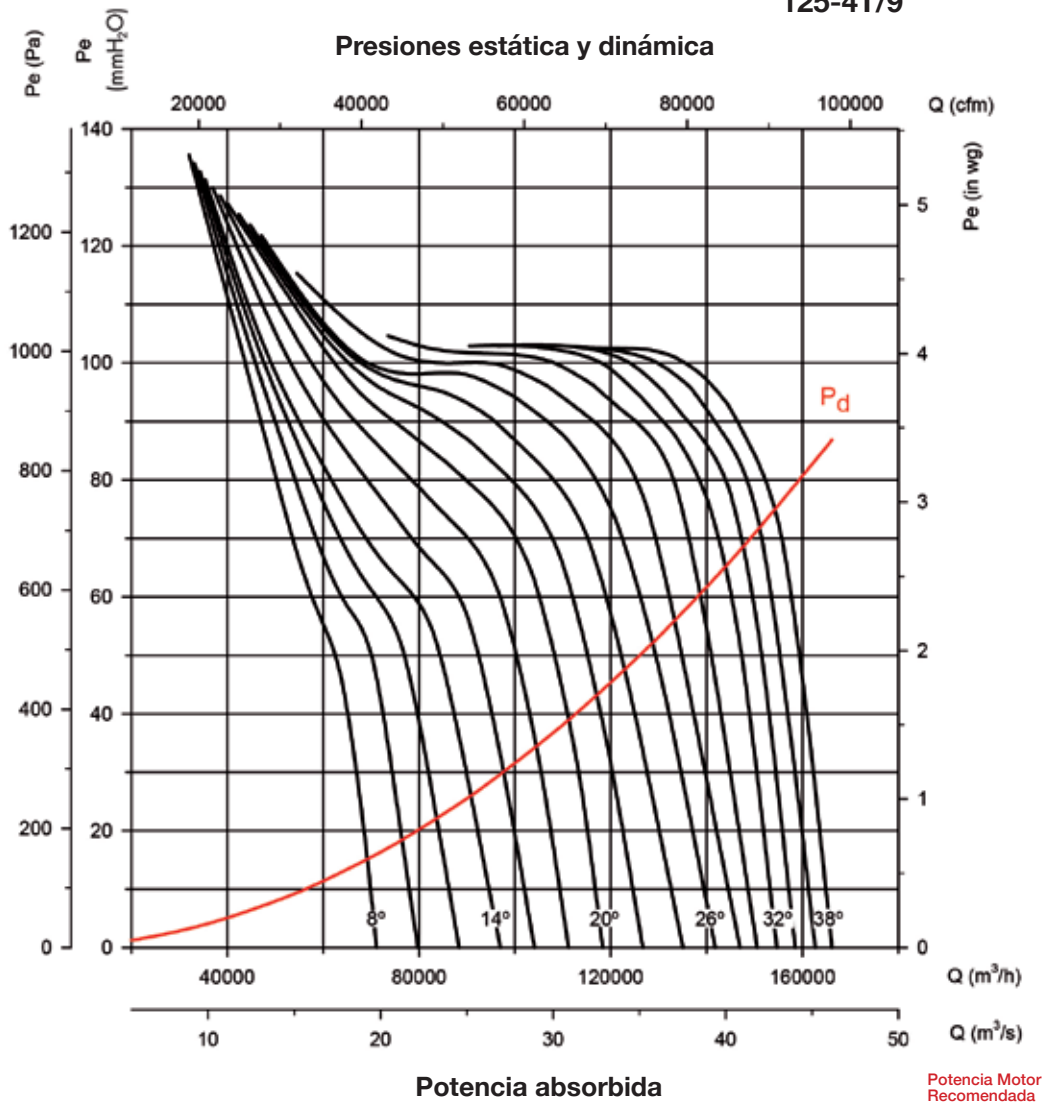

Potencia absorbida

Potencia Motor Recomendada kW(CV)

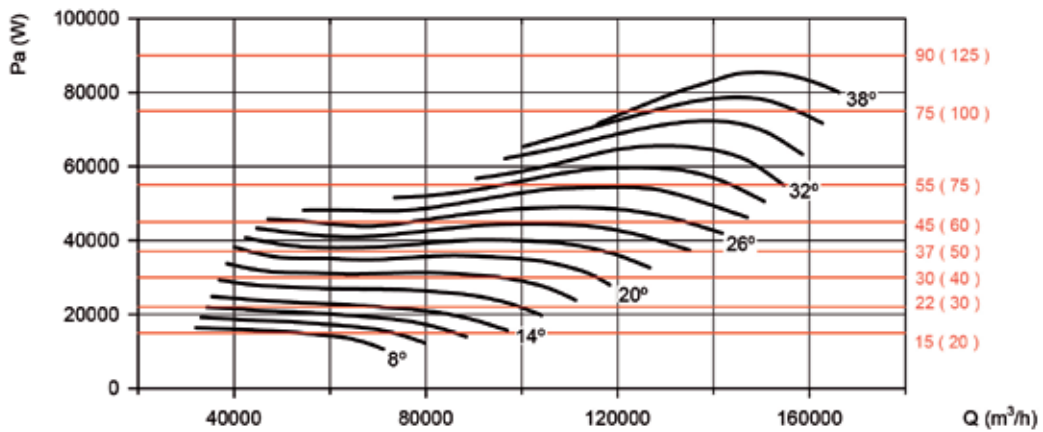

Curvas características

Q= Caudal en m³/h, m³/s y cfm.

Pe= Presión estática en mmH₂O, Pa e inwg.

125-6T/3

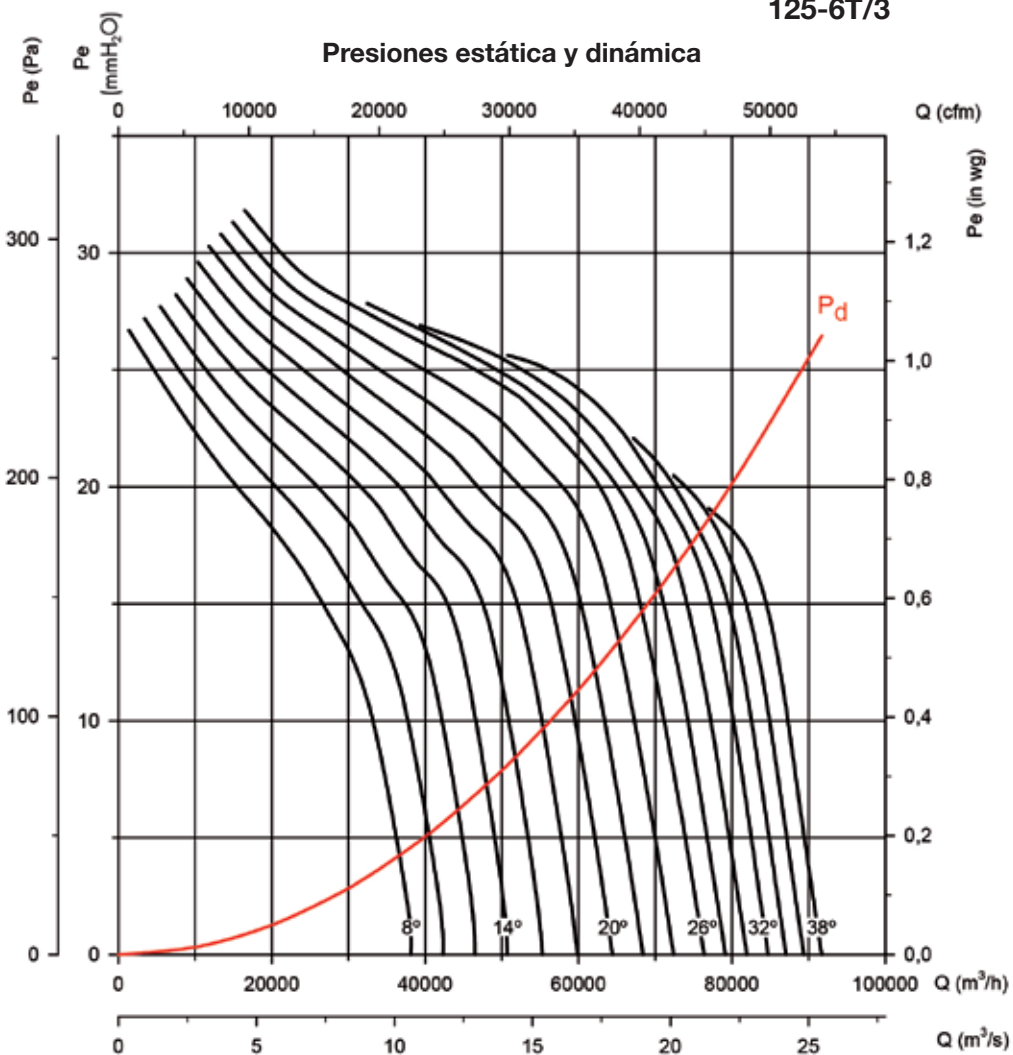

Potencia absorbida

Potencia Motor Recomendada kW(CV)

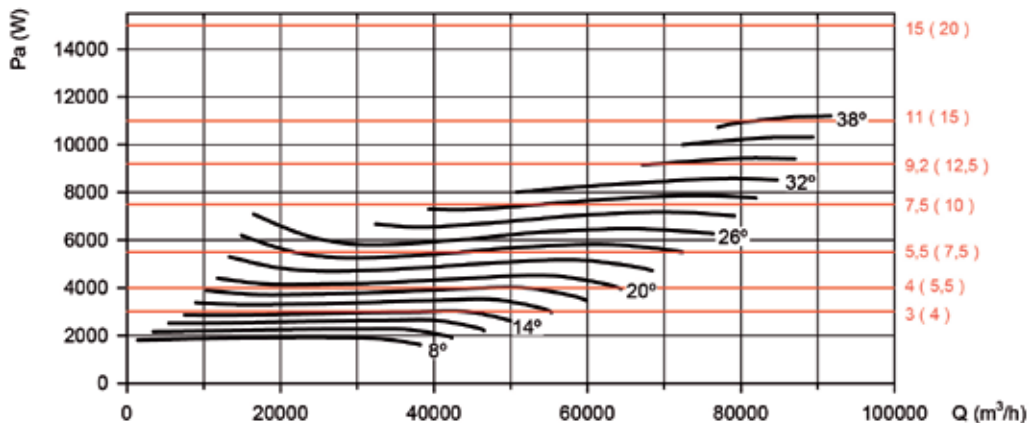

Curvas características

Q= Caudal en m³/h, m³/s y cfm.

Pe= Presión estática en mmH₂O, Pa e inwg.

125-6T/6

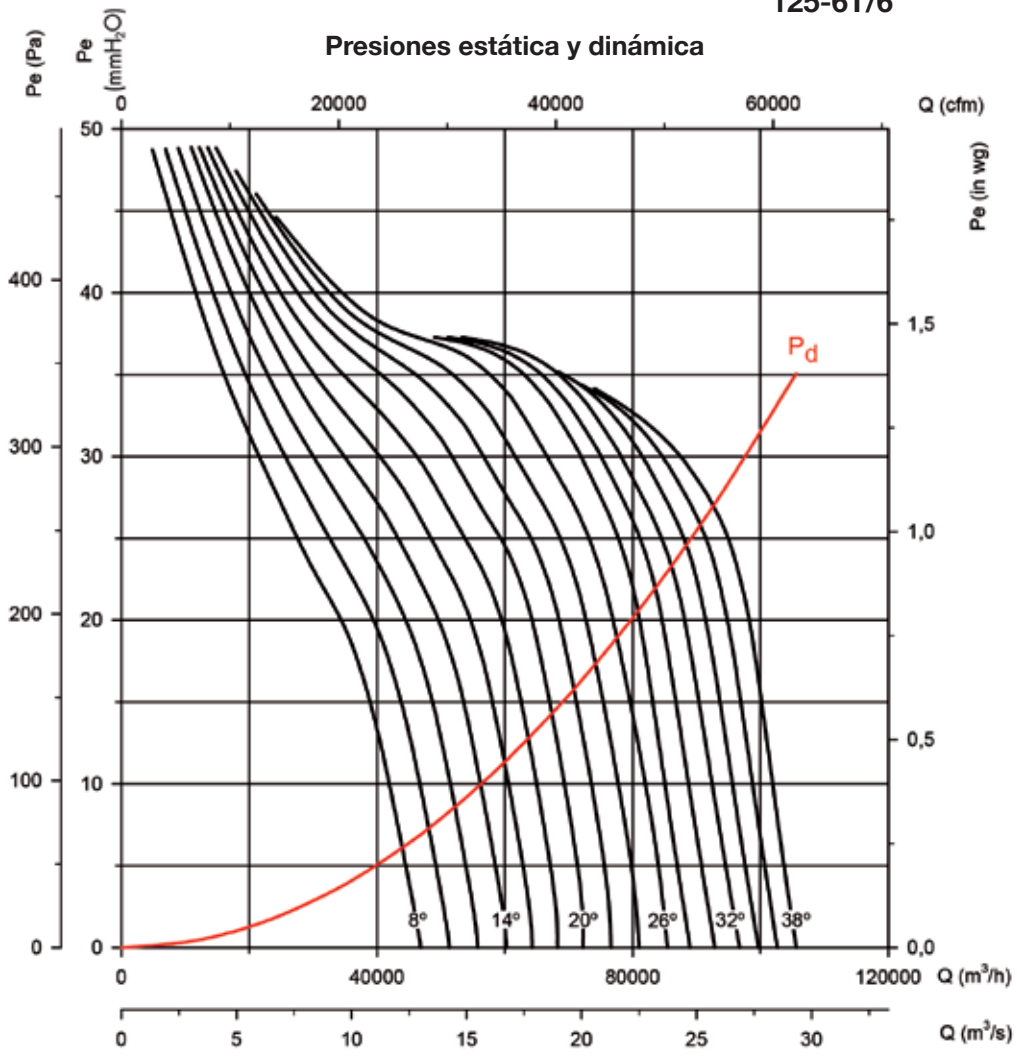

Potencia absorbida

Potencia Motor Recomendada kW(CV)

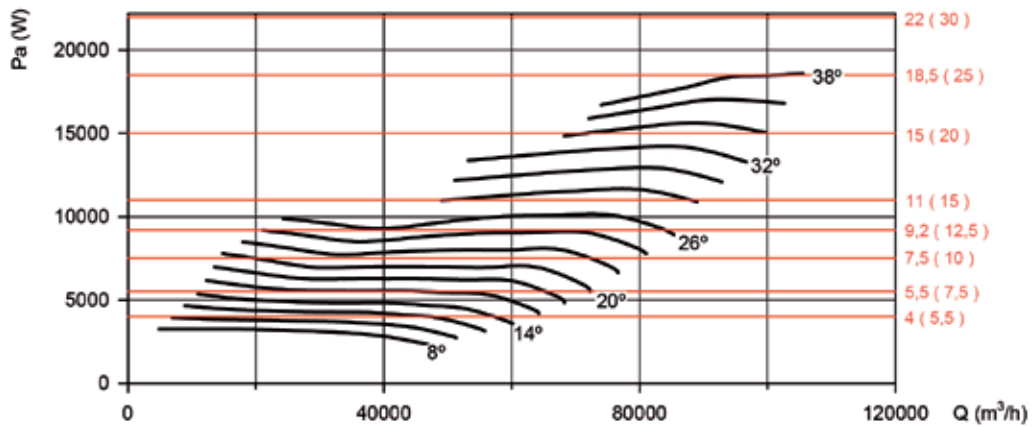

Curvas características

Q= Caudal en m³/h, m³/s y cfm.

Pe= Presión estática en mmH₂O, Pa e inwg.

125-6T/9

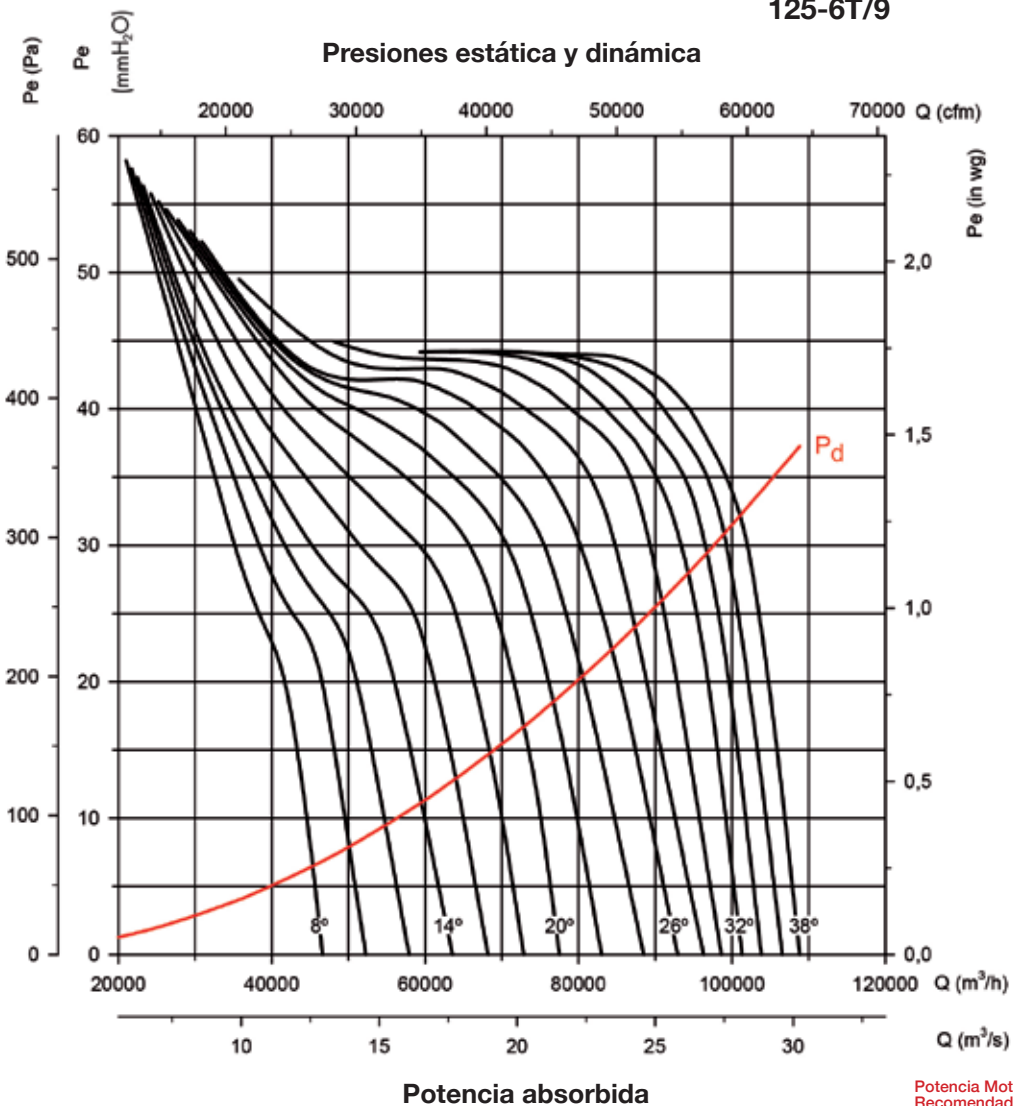

Potencia Motor Recomendada kW(CV)

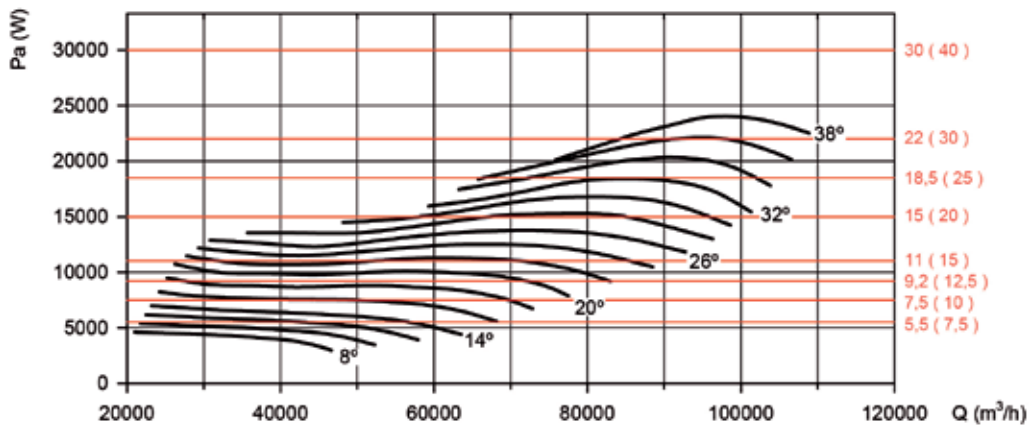

CERTIFICADO F-400



267

EXTRACTORES PARA LA EVACUACIÓN DE HUMOS EN PARQUEADORES Y SIMILARES F-300 F-400

<p>THT</p>  <p>Extractores helicoidales tubulares 400°C/2h y 300°C/2h</p> <p>272</p>	<p>CJTHT</p>  <p>Ventiladores helicoidales 400°C/2h, 300°C/2h y 200°C/2h. Con caja aislada acústicamente</p> <p>325</p>	<p>THT/IMP</p>  <p>Jet fans de gran alcance 400°C/2h y 300°C/2h, unidireccionales o reversibles, con diseño circular o octogonal</p> <p>331</p>	<p>CI</p>  <p>Ventiladores centrifugos de inducción e impulso de gran alcance 300°C/2h y 400°C/2h</p> <p>335</p>	<p>HTMF</p>  <p>Extractores de cubierta multifuncional 400°C/2h y 300°C/2h</p> <p>336</p>
<p>THT/ROOF</p>  <p>Extractores helicoidales de cubierta de salida de aire vertical 400°C/2h y 300°C/2h</p> <p>343</p>	<p>TCR/R</p>  <p>Extractor centrifugo 400°C/2h con turbina a reaccion</p> <p>346</p>	<p>CJTCR/R</p>  <p>Unidades de extracción 400°C/2h con turbina a reaccion</p> <p>346</p>	<p>CJTX-C</p>  <p>Unidades de extracción 400°C/2h, con motor y transmisión en el interior de la caja</p> <p>351</p>	<p>CJSX</p>  <p>Unidades de extracción 400°C/2h, a transmisión con ventilador de simple aspiración</p> <p>359</p>
<p>CSX</p>  <p>Extractores centrifugos 400 °C/2h, accionados a transmisión con turbina a reaccion</p> <p>365</p>				



EXTRACTORES PARA LA EVACUACIÓN DE HUMOS EN CASO DE INCENDIO

Gracias a los conocimientos adquiridos en los 25 años de experiencia, en la fabricación de ventiladores para trabajo continuo con alta temperatura, SODECA se ha especializado en la fabricación de extractores para la evacuación de humos en caso de incendios y sistemas de sobre presión para el control del humo en instalaciones de vías de escape en caso de incendio.

Si nuestros sistemas de fabricación están certificados por organismos exteriores de certificación de calidad como BUREAU VERITAS, los controles de calidad para los procesos de fabricación y control de los extractores, para la evacuación de humos con temperatura, están además, completamente auditados, por organismos independientes como APPLUS, para asegurar así el correcto funcionamiento y cumplimiento de normativas y características técnicas de los extractores.

Todos nuestros extractores para evacuación de humos cumplen con las exigencias de la Norma Europea EN 12101-3:2002/AC:2006 "Powered smoke and heat exhaust ventilators for use in Construction Works", y están certificados por laboratorio independiente y acreditado por las Directivas Europeas



EXTRACTORES CERTIFICADOS

PARA EVACUACIÓN DE HUMO EN CASO DE INCENDIO

Evacuación de humo para: **PARQUEADORES**

Método de evacuación de humo mediante extractores certificados para trabajo con temperatura durante un tiempo determinado según su clasificación y certificación. Este método es aplicado habitualmente en edificios, centros comerciales, túneles, aparcamientos y otras construcciones de gran superficie y con grandes áreas abiertas, también en naves industriales de alto riesgo de incendios y extracciones de humos en cocinas industriales.



VENTILADOR INMERSO

Instalación del ventilador inmerso en la zona de riesgo de incendio



THT



VENTILADOR EXTERIOR

Instalación del ventilador exterior a la zona de riesgo de incendio



CSX



CJTX-C



CJTCR/R



TCR/R



CJSX



JET FAN

Instalación del Jet Fan en la zona de riesgo de incendio



THT/IMP-O



THT/IMP-L



CI

Evacuación de humo para: **COCINAS INDUSTRIALES**

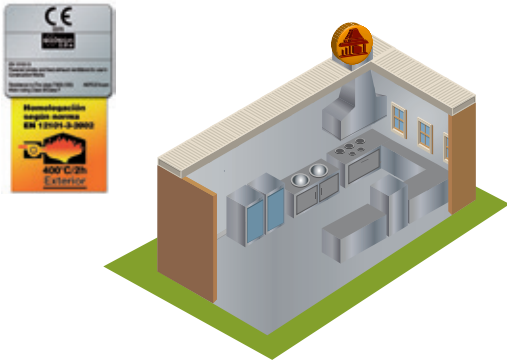

Extractores idóneos para aplicación en cocinas industriales

Para la correcta aplicación de la norma:

- C.T.E. Código Técnico de la Edificación. Documento Básico SI de seguridad en caso de incendio. Documento Básico HS de salubridad.

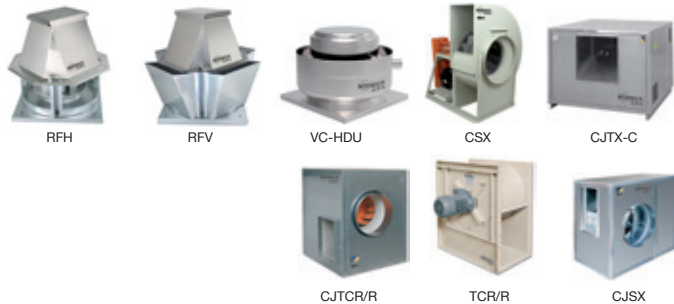

Evacuación de humo para: **NAVES INDUSTRIALES**



Extractores idóneos para aplicación en naves industriales

Para la correcta aplicación de la norma:

- Reglamento de Seguridad Contra Incendios en Establecimientos Industriales, Real Decreto 2267/2004, EN-23585:2004 Seguridad Contra Incendios

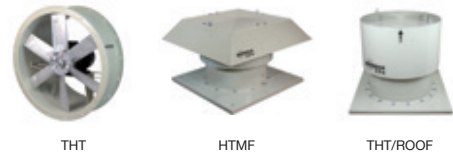

Control de humo por presión diferencial para: **VÍAS DE EVACUACIÓN**

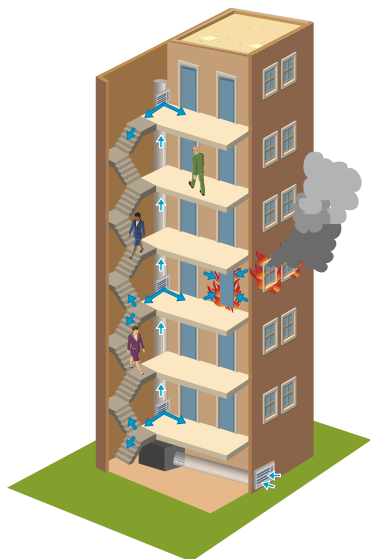

Método de control de humo por Sobrepresión, este sistema consiste en la presurización mediante inyección de aire en habitáculos que son utilizados como vías de escape de personas en caso de incendio, tales como cajas de escalera, pasillos, corredores, elevadores, etc. Sobre todo en edificios de altura con gran ocupación. Este método está basado en el control del humo mediante la velocidad del aire y la barrera artificial que crea la sobre presión del aire sobre el humo, para que éste no pueda entrar en las vías de escape. De acuerdo de la norma EN-12101-6-2006

KIT SOBREPRESIÓN DE ESCALERAS PARA EQUIPOS TRIFÁSICOS



KIT SOBREPRESIÓN DE ESCALERAS Para equipos monofásicos



KIT SOBREPRESIÓN CON VENTILADOR DE RESERVA





CI instalado en parking



CI instalado en parking



Máquina de humos, para realizar las pruebas reales de humos



THT/IMP instalado en parking

JET FANS

VENTILACIÓN EN PARQUEADORES

VENTILACIÓN POR IMPULSO

Como alternativa a los sistemas de ventilación tradicionales y mediante redes de conductos de extracción y aportación de aire, se han establecido durante los últimos años los sistemas de ventilación horizontal, también conocidos como sistemas de ventilación por impulso o por inducción.

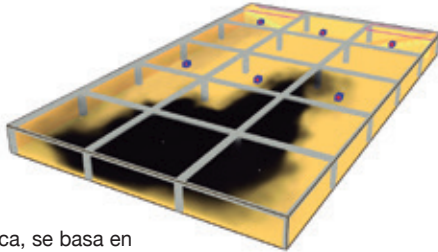

Esta novedosa técnica, se basa en reproducir los sistemas de ventilación longitudinal aplicados a los túneles, creando un frente de aire con suficiente velocidad para provocar el barrido del área a ventilar.

Mediante la instalación de ventiladores en puntos de entrada y salida del aire y humo, proporciona el fenómeno de inducción, extrayendo la masa de aire/humo hasta el exterior.

Este sistema de ventilación, se basa en la impulsión de una pequeña cantidad de aire a elevada velocidad, produciendo un efecto de homogenización al resto del aire.

El sistema permite además mantener unos niveles de concentración de gases contaminantes realmente bajos sin necesidad de recurrir a la puesta en marcha de todo el sistema de ventilación del aparcamiento.

Mediante la puesta en marcha únicamente de los ventiladores de inducción, o diseñando sistemas de ventilación zonificados, o en etapas, y con un sistema de detección de gases, podemos conseguir un menor consumo energético, menor nivel de ruido y una mayor vida útil de los equipos.

La ventilación por impulso permite diseñar sistemas para el control de humos en caso de incendio, según los tres objetivos fijados por las normativas inglesa y belga, que constituyen la base sobre la que está trabajando el Comité Europeo de Normalización para la redacción de la futura Norma Europea de Control de Humos en Aparcamientos EN 12101-11:

- Evacuar el humo durante y tras el incendio (smoke clearance)
- Facilitar la intervención de los servicios de extinción (fire fighting)
- Facilitar la evacuación segura de los ocupantes (means of escape)

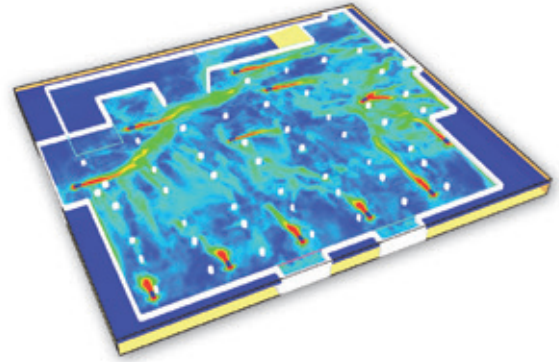

VENTAJAS DEL SISTEMA

Las dos ventajas más importantes del sistema de ventilación por impulso o inducción, son:

- Mantener un bajo nivel de concentración de los gases contaminantes
- Mayor seguridad para el control de los humos en caso de incendio

Además, dichos sistemas presentan los siguientes beneficios adicionales.

- Instalación más rápida y sencilla, así como menores interferencias con otras instalaciones (redes de sprinklers, canaletas eléctricas, desagües)
- Menor ocupación bajo forjado que facilita la instalación del sistema de ventilación en aparcamientos de altura reducida, y permite reducir los costes de excavación.
- Mayor visibilidad del aparcamiento y por consiguiente mejor funcionamiento de los sistemas de CCTV.
- Menor consumo del sistema de ventilación al no tener que vencer los ventiladores las pérdidas de carga de los conductos, así como al menor número de arrancadas y horas de funcionamiento.

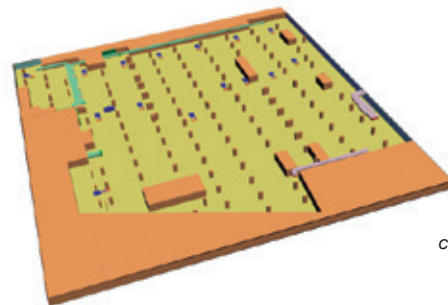

Ejemplos de estudios mediante simulaciones computacionales CFD

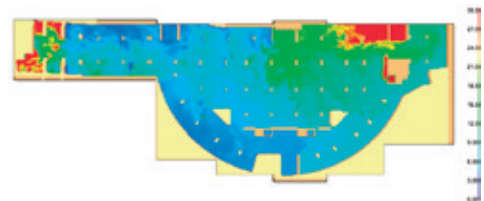

THT



Extractores helicoidales tubulares 400°C/2h y 300°C/2h

Extractores helicoidales tubulares con carcasa corta, para trabajar inmersos en zonas de riesgo de incendios 400°C/2h.

Ventilador:

- Envoltente tubular en chapa de acero.
- Hélices orientables en fundición de aluminio
- Homologación según norma EN-12101-3-2002
- Dirección aire motor-hélice

Motor:

- Motores clase H, uso continuo S1 y uso emergencia S2, con rodamientos a bolas, protección IP55, de 1 ó 2 velocidades según modelo
- Motor Multitensión, diseño especial válido para: 220/380V 60Hz, 254/440V 60Hz, 265/460V 60Hz, 277/480V 60Hz
- Temperatura máxima del aire a transportar: Servicio S1 -20°C+ 40°C en continuo, Servicio S2, 300°C/2h, 400°C/2h

Acabado:

- Anticorrosivo en resina de poliéster polimerizada a 190 °C, previo desengrase con tratamiento nanotecnológico libre de fosfatos.

Bajo demanda:

- Extractores con carcasa larga equipada con trampilla de inspección
- Hélices reversibles 100%



Código de pedido

De tamaño 40 a tamaño 100

THT	—	56	—	4T	—	2	—	F-400	—	60Hz
THT: Extractores helicoidales tubulares 400°C/2h y 300°C/2h		Diámetro hélice en cm.		Número de polos motor 2=3500 r/min. 60 Hz 4=1680 r/min. 60 Hz 6=1080 r/min. 60 Hz 8=900 r/min. 60 Hz 12=750 r/min. 60 Hz	T=Trifásico	Potencia motor (c.v.)		F-300: Homologación 300°C/2h F-400: Homologación 400°C/2h		
THT/CL: Extractores helicoidales tubulares 400°C/2h y 300°C/2h con carcasa larga, equipada con trampilla de inspección										

De tamaño 125 a tamaño 160

THT	—	125	—	4T	—	15	—	9-10	—	F-400	—	60Hz
THT: Extractores helicoidales tubulares 400°C/2h y 300°C/2h		Diámetro hélice en cm.		Número de polos motor 2=3500 r/min. 60 Hz 4=1680 r/min. 60 Hz 6=1080 r/min. 60 Hz 8=900 r/min. 60 Hz 12=750 r/min. 60 Hz	T=Trifásico	Potencia motor (c.v.)		Número de palas 3 palas 6 palas 9 palas	Angulo inclinación palas	F-300: Homologación 300°C/2h F-400: Homologación 400°C/2h		
THT/CL: Extractores helicoidales tubulares 400°C/2h y 300°C/2h con carcasa larga, equipada con trampilla de inspección												

Características técnicas

Modelo	Velocidad (r/min)	Intensidad máxima admisible (A)		Potencia instalada (kW)	Caudal máximo (m³/h)	Nivel presión sonora dB(A)	Peso aprox. (Kg)	
		220-277V	380-480V				Larga	Corta
THT-40-2T-1,5	3455	4,70	2,70	1,10	6750	76	33	31
THT-40-2/4T-1,5	3505/1750		2,90/2,10	1,10/0,25	6750/3400	76/61	34	32
THT-40-2T-2	3455	5,90	3,40	1,50	7350	77	35	33
THT-40-2/4T-2	3530/1750		4,40/1,40	1,50/0,37	7350/3650	77/62	35	33
THT-40-4T-0,75	1690	2,73	1,57	0,55	5800	64	32	29
THT-40-6T-0,75	1150	4,10	2,40	0,55	3800	53	37	34
THT-40-6/12T-0,75	1130/530		1,60/0,55	0,55/0,09	3800/1750	53/38	41	38
THT-45-2T-2	3455	5,90	3,40	1,50	8800	78	38	34
THT-45-2/4T-2	3530/1750		5,70/1,80	1,50/0,37	8800/4400	78/63	37	34
THT-45-2T-3	3480	8,70	5,00	2,20	11300	80	39	36
THT-45-2/4T-3	3515/1740		4,40/1,40	2,20/0,60	11300/5650	80/65	39	36
THT-45-4T-0,75	1690	2,73	1,57	0,55	7500	68	34	30
THT-45-6T-0,75	1150	4,10	2,40	0,55	6050	55	38	35
THT-45-6/12T-0,75	1130/530		1,60/0,55	0,55/0,09	6050/2800	55/40	42	39
THT-50-2T-4	3455	11,20	6,50	3,00	12100	82	49	42
THT-50-2/4T-4	3505/1730		6,70/2,00	3,00/0,80	12100/6050	82/67	51	44
THT-50-2T-5,5	3470		9,30	4,00	14300	83	65	57
THT-50-2/4T-6	3515/1740		10,00/3,20	4,50/1,30	15400/7700	83/68	67	60
THT-50-4T-1	1700	3,50	2,03	0,75	8950	69	37	33
THT-50-6T-0,75	1150	4,10	2,40	0,55	9150	57	40	36
THT-50-6/12T-0,75	1130/530		1,60/0,55	0,55/0,09	9150/4250	57/42	44	40
THT-56-2T-5,5	3505		9,50	4,00	18150	88	69	60
THT-56-2/4T-6	3515/1740		10,00/3,20	4,50/1,30	19650/9800	88/72	71	63
THT-56-2T-12	3540		19,20	9,00	27000	89	147	139
THT-56-2/4T-12	3505/1730		20,70/5,50	9,00/2,50	27000/13500	89/74	137	129
THT-56-4T-1	1715	3,50	2,00	0,75	10550	73	45	40
THT-56-4T-1,5	1715	4,80	2,80	1,10	12750	74	44	40
THT-56-4/8T-1,5	1730/850		2,90/1,40	1,10/0,25	12750/6300	74/59	48	43
THT-56-4T-2	1705	6,20	3,60	1,50	15000	75	48	43
THT-56-4/8T-2	1700/860		3,60/1,50	1,50/0,30	15000/7400	75/60	59	55
THT-56-6T-0,75	1150	4,10	2,40	0,55	10650	62	44	39
THT-56-6/12T-0,75	1130/530		1,60/0,55	0,55/0,09	10650/4950	62/47	48	43
THT-63-2T-12	3540		19,20	9,00	33100	90	161	143
THT-63-2/4T-12	3505/1730		18,50/5,50	9,00/2,50	33100/16550	90/75	151	133
THT-63-2T-22	3550		32,30	16,00	44750	91	188	170
THT-63-2/4T-22	3550/1775		32,30/8,90	16,00/4,00	44750/22400	91/76	188	170
THT-63-4T-1	1715	3,50	2,00	0,75	13800	73	49	43
THT-63-4T-1,5	1715	4,80	2,80	1,10	16550	74	51	45
THT-63-4/8T-1,5	1730/850		2,90/1,40	1,10/0,25	16550/8200	74/59	55	49
THT-63-4T-2	1705	6,20	3,60	1,50	19100	75	55	49
THT-63-4/8T-2	1700/860		3,60/1,50	1,50/0,30	19100/9450	75/60	70	60
THT-63-4T-3	1715	9,00	5,20	2,20	22400	76	64	54
THT-63-4/8T-3	1700/860		5,20/1,90	2,20/0,45	22400/11050	76/61	77	66
THT-63-4T-4	1715	11,40	6,60	3,00	25150	77	73	63
THT-63-4/8T-4	1710/850		6,80/2,20	3,00/0,60	25150/12450	77/62	86	77
THT-63-6T-0,75	1150	4,10	2,40	0,55	14650	65	51	45
THT-63-6/12T-0,75	1130/530		1,60/0,55	0,55/0,09	14650/6800	65/50	55	49
THT-63-6T-1	1140	4,70	2,70	0,75	15900	66	54	48
THT-63-6/12T-1	1130/530		2,20/0,87	0,75/0,15	15900/7400	66/51	61	55
THT-71-4T-1,5	1715	4,80	2,80	1,10	19950	78	58	52
THT-71-4/8T-1,5	1730/850		2,90/1,40	1,10/0,25	19950/9850	78/63	61	56
THT-71-4T-2	1705	6,20	3,60	1,50	19950	79	61	56
THT-71-4/8T-2	1700/860		3,60/1,50	1,50/0,30	19950/9850	79/64	76	67
THT-71-4T-3	1715	9,00	5,20	2,20	25250	81	70	61
THT-71-4/8T-3	1700/860		5,20/1,90	2,20/0,45	25250/12450	81/66	82	74
THT-71-4T-4	1715	11,40	6,60	3,00	28100	82	79	70
THT-71-4/8T-4	1710/850		6,80/2,20	3,00/0,60	28100/13900	82/67	92	83
THT-71-6T-0,75	1150	4,10	2,40	0,55	15400	67	57	52

Características técnicas

Modelo	Velocidad (r/min)	Intensidad máxima admisible (A)		Potencia instalada (kW)	Caudal máximo (m³/h)	Nivel presión sonora dB(A)	Peso aprox. (Kg)	
		220-277V	380-480V				Larga	Corta
THT-71-6/12T-0,75	1130/530		1,60/0,55	0,55/0,09	15400/7150	67/52	61	56
THT-71-6T-1	1140	4,70	2,70	0,75	17450	68	61	55
THT-71-6/12T-1	1130/530		2,20/0,87	0,75/0,15	17450/8100	68/53	67	62
THT-71-6T-1,5	1130	5,50	3,20	1,10	20300	69	69	61
THT-71-6/12T-1,5	1140/565		3,00/1,15	1,10/0,18	20300/9450	69/54	77	69
THT-80-4T-3	1715	9,00	5,20	2,20	25050	82	79	69
THT-80-4/8T-3	1700/860		5,20/1,90	2,20/0,45	25050/12400	82/67	91	82
THT-80-4T-4	1715	11,40	6,60	3,00	27850	83	88	78
THT-80-4/8T-4	1710/850		6,80/2,20	3,00/0,60	27850/13750	83/68	101	92
THT-80-4T-5,5	1720		8,40	4,00	33450	84	94	85
THT-80-4/8T-5,5	1745/870		9,30/3,40	4,00/0,80	33450/16550	84/69	127	118
THT-80-6T-1,5	1130	5,50	3,20	1,10	20100	72	78	69
THT-80-6/12T-1,5	1140/565		3,00/1,15	1,10/0,18	20100/9350	72/57	86	77
THT-80-6T-2	1135	7,40	4,30	1,50	23900	73	87	78
THT-80-6/12T-2	1140/550		4,60/1,90	1,50/0,25	23900/11100	73/58	91	82
THT-80-6T-3	1120	9,50	5,50	2,20	30150	74	94	84
THT-80-6/12T-3	1130/565		5,60/2,20	2,20/0,37	30150/14000	74/59	100	91
THT-80-8T-0,75	840	3,60	2,10	0,55	16550	70	71	62
THT-80-8T-1	850	4,80	2,80	0,75	19550	71	78	69
THT-90-4T-4	1715	11,40	6,60	3,00	34700	87	110	93
THT-90-4/8T-4	1710/850		6,80/2,20	3,00/0,60	34700/17150	87/72	124	106
THT-90-4T-5,5	1720		8,40	4,00	39900	89	117	99
THT-90-4/8T-5,5	1745/870		9,30/3,40	4,00/0,80	39900/19700	89/74	150	132
THT-90-4T-7,5	1750		12,60	5,50	43350	91	143	126
THT-90-4/8T-7,5	1745/870		12,80/4,60	5,50/1,10	43350/21450	91/76	157	140
THT-90-4T-10	1750		17,70	7,50	50000	92	154	137
THT-90-4/8T-9	1745/870		15,60/6,30	6,70/1,50	46850/23150	92/77	157	140
THT-90-6T-2	1135	7,40	4,30	1,50	28400	77	110	92
THT-90-6/12T-2	1140/550		4,60/1,90	1,50/0,25	28400/13200	77/62	114	96
THT-90-6T-3	1120	9,50	5,50	2,20	32750	78	116	99
THT-90-6/12T-3	1130/565		5,60/2,20	2,20/0,37	32750/15250	78/63	123	105
THT-90-6T-4	1165	13,50	7,80	3,00	38150	79	142	124
THT-90-6/12T-4	1150/570		8,90/3,50	3,00/0,55	38150/17750	79/64	143	126
THT-90-8T-1	850	4,80	2,80	0,75	23150	71	100	84
THT-90-8T-2	850	7,80	4,50	1,50	29850	73	116	99
THT-90-8T-3	850	11,40	6,60	2,20	35350	74	134	116
THT-100-4T-7,5	1750		12,60	5,50	51700	92	151	131
THT-100-4/8T-7,5	1745/870		12,80/4,60	5,50/1,10	46950/23200	92/77	165	145
THT-100-4T-10	1750		17,70	7,50	56400	93	162	142
THT-100-4/8T-9	1745/870		15,60/6,30	6,70/1,50	56400/27900	93/78	165	145
THT-100-4T-15	1750		22,00	11,00	65850	94	215	195
THT-100-4/8T-15	1765/870		23,20/8,70	11,00/2,80	65850/32550	94/79	215	195
THT-100-4T-20	1750		29,00	15,00	72500	95	230	210
THT-100-4/8T-20	1765/870		31,70/11,80	15,00/3,80	72500/35850	95/80	230	210
THT-100-6T-3	1120	9,50	5,50	2,20	36950	82	124	105
THT-100-6/12T-3	1130/565		5,60/2,20	2,20/0,37	36950/17200	82/67	130	112
THT-100-6T-4	1165	13,50	7,80	3,00	43150	83	150	130
THT-100-6/12T-4	1150/570		8,90/3,50	3,00/0,55	43150/20050	83/68	151	131
THT-100-6T-5,5	1165		11,00	4,00	47500	84	162	142
THT-100-6/12T-5,5	1165/575		11,30/4,20	4,00/0,65	47500/22100	84/69	162	142
THT-100-8T-2	850	7,80	4,50	1,50	32550	77	124	105
THT-100-8T-3	850	11,40	6,60	2,20	37450	77	142	122
THT-100-8T-4	850	15,60	9,00	3,00	43400	78	162	142
THT-125-4T/3-10	1750		17,70	7,50	54400	88	243	210
THT-125-4/8T/3-9	1745/870		15,60/6,30	6,70/1,50	50550/25000	88/68	243	210
THT-125-4T/3-15	1750		22,00	11,00	69800	89	294	266
THT-125-4/8T/3-15	1765/870		23,20/8,70	11,00/2,80	69800/34500	89/69	294	266
THT-125-4T/3-20	1750		29,00	15,00	77500	91	309	281

Características técnicas

Modelo	Velocidad (r/min)	Intensidad máxima admisible (A)		Potencia instalada (kW)	Caudal máximo (m³/h)	Nivel presión sonora dB(A)	Peso aprox. (Kg)	
		220-277V	380-480V				Larga	Corta
THT-125-4/8T/3-20	1765/870		31,70/11,80	15,00/3,80	77500/38300	91/71	309	281
THT-125-4T/3-25	1760		37,00	18,50	92950	91	377	334
THT-125-4T/3-30	1765		42,00	22,00	101300	92	391	348
THT-125-4/8T/3-27	1765/880		38,00/13,00	20,00/4,00	92950/45950	92/71	391	348
THT-125-4/8T/3-37	1770/880		51,00/20,60	27,00/6,00	118000/58350	93/72	472	429
THT-125-4T/3-40	1770		58,00	30,00	118000	93	472	429
THT-125-4/8T/3-40	1775/880		62,00/27,00	30,00/10,00	118000/58350	93/72	618	562
THT-125-4T/6-20	1750		29,00	15,00	69250	89	318	290
THT-125-4/8T/6-20	1765/870		31,70/11,80	15,00/3,80	73400/36250	89/68	318	290
THT-125-4/8T/6-22	1765/880		31,80/12,00	16,50/3,30	77500/38300	89/69	303	275
THT-125-4T/6-25	1760		37,00	18,50	81600	90	386	343
THT-125-4/8T/6-27	1765/880		38,00/13,00	20,00/4,00	85750/42350	90/69	400	357
THT-125-4T/6-30	1765		42,00	22,00	93950	90	400	357
THT-125-4/8T/6-37	1770/880		51,00/20,60	27,00/6,00	102200/50500	90/70	481	437
THT-125-4T/6-40	1770		58,00	30,00	110400	92	481	437
THT-125-4/8T/6-40	1775/880		62,00/27,00	30,00/10,00	110400/54600	92/71	627	571
THT-125-4T/6-50	1775		73,00	37,00	117700	93	529	473
THT-125-4T/9-25	1760		37,00	18,50	69850	88	395	352
THT-125-4/8T/9-22	1765/880		31,80/12,00	16,50/3,30	59500/29400	88/69	312	284
THT-125-4T/9-30	1765		42,00	22,00	85350	89	409	366
THT-125-4/8T/9-27	1765/880		38,00/13,00	20,00/4,00	75000	89/70	409	366
THT-125-4/8T/9-37	1770/880		51,00/20,60	27,00/6,00	85350/42200	90/70	490	446
THT-125-4T/9-40	1770		58,00	30,00	95700	91	490	446
THT-125-4/8T/9-40	1775/880		62,00/27,00	30,00/10,00	95700/47300	91/71	636	580
THT-125-4T/9-50	1775		73,00	37,00	106050	93	538	482
THT-125-6T/3-4	1165	13,50	7,80	3,00	35650	79	230	197
THT-125-6/12T/3-4	1150/570		8,90/3,50	3,00/0,55	40700/18900	79/64	232	199
THT-125-6T/3-5,5	1165		11,00	4,00	50800	80	242	209
THT-125-6/12T/3-5,5	1165/575		11,30/4,20	4,00/0,65	50800/23600	80/65	243	210
THT-125-6T/3-7,5	1165		12,40	5,50	60900	81	249	216
THT-125-6/12T/3-7,5	1165/575		13,20/5,30	5,50/1,00	60900/28300	81/66	263	230
THT-125-6T/3-10	1165		17,00	7,50	71850	83	274	246
THT-125-6/12T/3-10	1150/565		20,00/9,00	7,50/1,40	71850/33400	83/68	294	266
THT-125-6T/3-15	1145		26,00	11,00	91650	84	304	276
THT-125-6/12T/3-15	1150/565		28,50/13,00	11,00/2,00	91650/42600	84/69	309	281
THT-125-6T/3-20	1170		31,00	15,00	101650	85	377	334
THT-125-6/12T/3-24	1165/575		36,00/14,50	17,50/3,50	104450/48550	85/70	472	429
THT-125-6T/6-5,5	1165		11,00	4,00	45400	77	251	218
THT-125-6/12T/6-5,5	1165/575		11,30/4,20	4,00/0,65	50750/23600	77/62	252	219
THT-125-6T/6-7,5	1165		12,40	5,50	56150	77	258	225
THT-125-6/12T/6-7,5	1165/575		13,20/5,30	5,50/1,00	56150/26100	77/62	272	239
THT-125-6T/6-10	1165		17,00	7,50	66950	79	283	255
THT-125-6/12T/6-10	1150/565		20,00/9,00	7,50/1,40	66950/31150	79/64	303	275
THT-125-6T/6-15	1145		26,00	11,00	81900	81	313	285
THT-125-6/12T/6-15	1150/565		28,50/13,00	11,00/2,00	81900/38100	81/66	318	290
THT-125-6T/6-20	1170		31,00	15,00	91950	82	386	343
THT-125-6/12T/6-24	1165/575		36,00/14,50	17,50/3,50	102550/47700	82/67	481	437
THT-125-6T/9-10	1165		17,00	7,50	55900	78	292	264
THT-125-6/12T/9-10	1150/565		20,00/9,00	7,50/1,40	55900/26000	78/63	312	284
THT-125-6T/9-15	1145		26,00	11,00	76250	81	322	294
THT-125-6/12T/9-15	1150/565		28,50/13,00	11,00/2,00	76250/35450	81/66	327	299
THT-125-6T/9-20	1170		31,00	15,00	87450	84	395	352
THT-125-6/12T/9-24	1165/575		36,00/14,50	17,50/3,50	93050/43250	84/69	490	446
THT-140-6T/3-5,5	1130		8,72	4,00	47700	83	279	242
THT-140-6T/3-7,5	1150		12,20	5,50	61200	84	287	250
THT-140-6T/3-10	1165		15,60	7,50	67950	85	339	300
THT-140-6T/3-15	1165		23,30	11,00	88800	86	356	317
THT-140-6T/3-20	1165		27,40	15,00	103450	88	436	386

Características técnicas

Modelo	Velocidad (r/min)	Intensidad máxima admisible (A)		Potencia instalada (kW)	Caudal máximo (m³/h)	Nivel presión sonora dB(A)	Peso aprox. (Kg)	
		220-277V	380-480V				Larga	Corta
THT-140-6T/6-7,5	1150		12,20	5,50	60700	84	297	260
THT-140-6T/6-10	1165		15,60	7,50	67950	85	349	310
THT-140-6T/6-15	1165		23,30	11,00	82350	86	366	327
THT-140-6T/6-20	1165		27,40	15,00	96800	87	445	396
THT-140-6T/6-25	1170		34,40	18,50	103200	88	497	448
THT-140-6T/6-30	1170		41,40	22,00	116000	89	506	457
THT-140-6T/9-10	1165		15,60	7,50	56700	84	358	319
THT-140-6T/9-15	1165		23,30	11,00	74850	86	375	336
THT-140-6T/9-20	1165		27,40	15,00	83900	87	455	405
THT-140-6T/9-25	1170		34,40	18,50	102050	88	506	458
THT-140-6T/9-30	1170		41,40	22,00	109500	89	515	467
THT-140-6T/9-40	1180		54,20	30,00	124500	91	673	611
THT-140-6T/9-50	1175		66,40	37,00	133300	92	751	696
THT-140-8T/3-3	860	9,17	5,27	2,20	41050	78	279	242
THT-140-8T/3-4	850	12,50	7,20	3,00	51250	78	287	250
THT-140-8T/3-5,5	875		10,40	4,00	61450	79	337	298
THT-140-8T/3-7,5	875		13,80	5,50	72500	81	346	307
THT-140-8T/3-10	870		17,80	7,50	87700	82	357	318
THT-140-8T/6-3	860	9,17	5,27	2,20	45800	78	289	252
THT-140-8T/6-4	850	12,50	7,20	3,00	51250	79	297	260
THT-140-8T/6-5,5	875		10,40	4,00	56700	80	347	308
THT-140-8T/6-7,5	875		13,80	5,50	67600	81	356	317
THT-140-8T/6-10	870		17,80	7,50	77850	82	367	328
THT-140-8T/6-15	870		21,70	11,00	92850	83	453	404
THT-140-8T/9-4	850	12,50	7,20	3,00	42750	79	306	269
THT-140-8T/9-5,5	875		10,40	4,00	49600	79	356	317
THT-140-8T/9-7,5	875		13,80	5,50	56450	81	365	326
THT-140-8T/9-10	870		17,80	7,50	70150	82	376	337
THT-140-8T/9-15	870		21,70	11,00	82600	83	463	413
THT-140-8T/9-20	870		32,90	15,00	100550	86	516	468
THT-160-6T/3-10	1165		15,60	7,50	71150	83	412	358
THT-160-6T/3-15	1165		23,30	11,00	91350	85	429	375
THT-160-6T/3-20	1165		27,40	15,00	101450	86	522	453
THT-160-6T/3-25	1170		34,40	18,50	121600	87	574	504
THT-160-6T/3-30	1170		41,40	22,00	132550	89	583	513
THT-160-6T/6-15	1165		23,30	11,00	90650	85	440	386
THT-160-6T/6-20	1165		27,40	15,00	101400	86	532	463
THT-160-6T/6-25	1170		34,40	18,50	112200	87	584	515
THT-160-6T/6-30	1170		41,40	22,00	122950	88	593	524
THT-160-6T/6-40	1180		54,20	30,00	144500	89	768	669
THT-160-6T/6-50	1175		66,40	37,00	163600	91	842	757
THT-160-6T/9-15	1165		23,30	11,00	71100	85	450	396
THT-160-6T/9-20	1165		27,40	15,00	84600	86	542	473
THT-160-6T/9-25	1170		34,40	18,50	98150	87	594	525
THT-160-6T/9-30	1170		41,40	22,00	111700	88	603	534
THT-160-6T/9-40	1180		54,20	30,00	125250	89	778	679
THT-160-6T/9-50	1175		66,40	37,00	152300	90	852	768
THT-160-6T/9-60	1180		84,50	45,00	163500	91	1067	968
THT-160-6T/9-75	1180		100,00	55,00	174650	92	1112	1013
THT-160-8T/3-4	850	12,50	7,20	3,00	53700	77	356	304
THT-160-8T/3-5,5	875		10,40	4,00	61300	79	410	356
THT-160-8T/3-7,5	875		13,80	5,50	68900	80	419	365
THT-160-8T/3-10	870		17,80	7,50	84150	81	430	376
THT-160-8T/3-15	870		21,70	11,00	108250	83	530	461
THT-160-8T/6-5,5	875		10,40	4,00	68350	77	421	367
THT-160-8T/6-7,5	875		13,80	5,50	76500	79	430	376
THT-160-8T/6-10	870		17,80	7,50	84650	80	441	387
THT-160-8T/6-15	870		21,70	11,00	100900	82	540	471

Características técnicas

Modelo	Velocidad (r/min)	Intensidad máxima admisible (A)		Potencia instalada (kW)	Caudal máximo (m³/h)	Nivel presión sonora dB(A)	Peso aprox. (Kg)	
		220-277V	380-480V				Larga	Corta
THT-160-8T/6-20	870		32,90	15,00	116200	83	594	525
THT-160-8T/6-25	875		34,90	18,50	130600	84	741	642
THT-160-8T/9-7,5	875		13,80	5,50	63850	79	440	386
THT-160-8T/9-10	870		17,80	7,50	74050	80	451	397
THT-160-8T/9-15	870		21,70	11,00	84250	82	550	481
THT-160-8T/9-20	870		32,90	15,00	104700	83	604	535
THT-160-8T/9-25	875		34,90	18,50	114900	84	751	652
THT-160-8T/9-30	875		41,10	22,00	131750	85	776	677
THT-160-8T/9-40	875		56,30	30,00	150100	86	837	753

Características acústicas

Los valores indicados, se determinan mediante medidas de nivel de presión y potencia sonora en dB(A) obtenidas en campo libre a una distancia equivalente a dos veces la envergadura del ventilador más el diámetro de la hélice, con un mínimo de 1,5 mts.

Espectro de potencia sonora Lw(A) en dB(A) por banda de frecuencia en Hz

Modelo	63	125	250	500	1000	2000	4000	8000	Modelo	63	125	250	500	1000	2000	4000	8000
40-2-1,5	48	69	76	81	84	80	73	62	71-12-0,75	29	44	52	57	59	56	49	38
40-2-2	49	70	77	82	85	81	74	63	71-12-1	30	46	54	59	61	58	51	40
40-4-0,75	36	57	64	69	72	68	61	50	71-12-1,5	31	46	54	59	61	58	51	40
40-4-1,5	33	54	61	66	69	65	58	47	80-4-3	57	77	85	90	92	89	82	73
40-4-2	34	55	62	67	70	66	59	48	80-4-4	56	76	84	89	91	88	81	74
40-6	25	46	53	58	61	57	50	39	80-4-5,5	56	76	84	89	91	88	81	70
40-12	10	31	38	43	46	42	35	24	80-6-1,5	49	66	74	79	81	78	71	60
45-2-2	50	71	78	83	86	82	75	64	80-6-2	50	67	75	80	82	79	72	61
45-2-3	52	73	80	85	88	84	77	66	80-6-3	51	68	76	81	83	80	73	62
45-4-0,75	40	61	68	73	76	72	65	54	80-8-0,75	47	60	68	73	75	72	65	54
45-4-2	35	56	63	68	71	67	60	49	80-8-1	48	61	69	74	76	73	66	55
45-4-3	37	58	65	70	73	69	62	51	80-8-3	42	62	70	75	77	74	67	58
45-6	27	48	55	60	63	59	52	41	80-8-4	41	61	69	74	76	73	66	59
45-12	12	33	40	45	48	44	37	26	80-8-5,5	40	60	68	73	75	72	65	59
50-2-4	57	77	85	90	92	89	82	71	80-12-1,5	34	49	57	62	64	61	54	43
50-2-5,5	58	78	86	91	93	90	83	72	80-12-2	35	50	58	63	65	62	55	44
50-2-6	58	78	86	91	93	90	83	72	80-12-3	36	51	59	64	66	63	56	45
50-4-1	44	64	72	77	79	76	69	58	90-4-4	61	82	89	94	97	93	86	79
50-4-4	42	62	70	75	77	74	67	56	90-4-5,5	60	81	88	93	96	92	85	74
50-4-6	43	63	71	76	78	75	68	57	90-4-7,5	59	80	87	92	95	91	84	73
50-6	32	52	60	65	67	64	57	46	90-4-9	58	79	86	91	94	90	83	72
50-12	17	37	45	50	52	49	42	31	90-4-10	58	79	86	91	94	90	83	72
50-2-5,5	63	83	91	96	98	95	88	77	90-6-2	49	70	77	82	85	81	74	63
56-2-6	63	83	91	96	98	95	88	77	90-6-3	56	70	77	82	85	81	74	63
56-2-12	64	84	92	97	99	96	89	78	90-6-4	57	72	79	84	87	83	76	65
56-4-1	48	68	76	81	83	80	73	62	90-8-1	42	63	70	75	78	74	67	56
56-4-1,5	49	69	77	82	84	81	74	63	90-8-2	51	66	73	78	81	77	70	59
56-4-2	50	70	78	83	85	82	75	64	90-8-3	52	66	73	78	81	77	70	59
56-4-6	48	68	76	81	83	80	73	62	90-8-4	46	67	74	79	82	78	71	64
56-4-12	49	69	77	82	84	81	74	63	90-8-5,5	45	66	73	78	81	77	70	59
56-6	37	57	65	70	72	69	62	51	90-8-7,5	43	64	71	76	79	75	68	57
56-8-1,5	34	54	62	67	69	66	59	48	90-8-9	43	64	71	76	79	75	68	57
56-8-2	35	55	63	68	70	67	60	49	90-12-2	32	53	60	65	68	64	57	46
56-12	22	42	50	55	57	54	47	36	90-12-3	41	53	60	65	68	64	57	46
63-2-12	67	87	95	100	102	99	92	81	90-12-4	42	55	62	67	70	66	59	48
63-2-22	68	88	96	101	103	100	93	82	100-4-7,5	64	84	92	97	99	96	89	78
63-4-1	50	70	78	83	85	82	75	64	100-4-9	63	83	91	96	98	95	88	77
63-4-1,5	48	68	76	81	83	80	73	65	100-4-10	62	82	90	95	97	94	87	76
63-4-2	52	68	76	81	83	80	73	66	100-4-15	61	81	89	94	96	93	86	75
63-4-3	53	70	78	83	85	82	77	67	100-4-20	63	83	91	96	98	95	88	77
63-4-4	54	71	79	84	86	83	78	68	100-6-3	61	72	80	85	87	84	77	66
63-4-12	52	72	80	85	87	84	77	66	100-6-4	64	72	80	85	87	84	77	66
63-4-22	53	73	81	86	88	85	78	67	100-6-5,5	64	73	81	86	88	85	78	67
63-6-0,75	42	60	68	73	75	72	65	56	100-8-2	56	66	74	79	81	78	71	60
63-6-1	43	62	70	75	77	74	67	57	100-8-3	57	68	76	81	83	80	73	62
63-8-1,5	33	53	61	66	68	65	58	50	100-8-4	58	68	76	81	83	80	73	62
63-8-2	37	53	61	66	68	65	58	51	100-8-7,5	49	69	77	82	84	81	74	63
63-8-3	38	55	63	68	70	67	62	52	100-8-9	48	68	76	81	83	80	73	62
63-8-4	39	56	64	69	71	68	63	53	100-8-15	46	66	74	79	81	78	71	60
63-12-0,75	27	43	51	56	58	55	48	37	100-8-20	47	67	75	80	82	79	72	61
63-12-1	28	45	53	58	60	57	50	42	100-12-3	46	55	63	68	70	67	60	49
71-4-1,5	54	74	82	87	89	86	79	69	100-12-4	48	55	63	68	70	67	60	49
71-4-2	53	73	81	86	88	85	78	70	100-12-5,5	49	56	64	69	71	68	61	50
71-4-3	58	72	80	85	87	84	77	71	125-4/3-9	70	76	88	98	98	94	86	82
71-4-4	59	73	81	86	88	85	78	72	125-4/3-10	70	76	88	98	98	94	86	82
71-6-0,75	44	63	72	74	76	73	66	55	125-4/3-15	71	77	89	99	99	95	87	83
71-6-1	45	65	73	75	77	74	67	56	125-4/3-20	73	79	91	101	101	97	89	85
71-6-1,5	46	66	71	76	78	75	68	57	125-4/3-25	73	79	91	101	101	97	89	85
71-8-1,5	38	58	66	71	73	70	63	54	125-4/3-27	74	80	92	102	102	98	90	86
71-8-2	38	58	66	71	73	70	63	55	125-4/3-30	74	80	92	102	102	98	90	86
71-8-3	43	57	65	70	72	69	62	56	125-4/3-37	75	81	93	103	103	99	91	87
71-8-4	44	58	66	71	73	70	63	57	125-4/3-40	75	81	93	103	103	99	91	87

Dimensiones mm

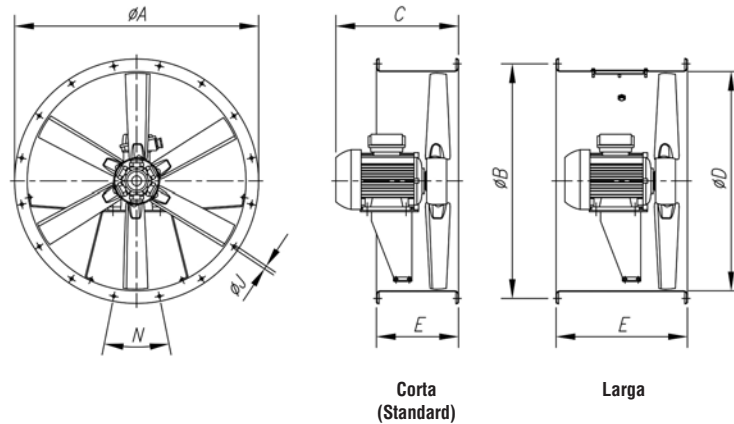

C (Consultar tamaño motor según potencia)

Modelo	ØA	ØB	C (Consultar tamaño motor según potencia)																ØD	E		ØJ	N
			80	90S	90L	100	112	132S	132M	132ML	160M	160L	180M	180L	200L	225	250	280		Corta	Larga		
THT-40	490	450	348	364	389	-	-	-	-	-	-	-	-	-	-	-	-	410	250	400	12	8x45°	
THT-45	540	500	348	364	389	-	-	-	-	-	-	-	-	-	-	-	-	460	250	400	12	8x45°	
THT-50	600	560	339	364	389	-	-	-	-	-	-	-	-	-	-	-	-	514	250	400	12	12x30°	
THT-50	600	560	-	-	-	419	438	-	-	-	-	-	-	-	-	-	-	514	250	500	12	12x30°	
THT-56	660	620	275	364	389	-	-	-	-	-	-	-	-	-	-	-	-	560	250	400	12	12x30°	
THT-56	660	620	-	-	-	416	432	480	518	-	-	-	-	-	-	-	-	560	250	500	12	12x30°	
THT-56	660	620	-	-	-	-	-	-	-	620	-	-	-	-	-	-	-	560	250	650	12	12x30°	
THT-63	730	690	339	359	389	-	-	-	-	-	-	-	-	-	-	-	-	640	250	400	12	12x30°	
THT-63	730	690	-	-	-	420	437	-	-	-	-	-	-	-	-	-	-	640	250	500	12	12x30°	
THT-63	730	690	-	-	-	-	-	539	577	-	-	-	-	-	-	-	-	640	250	650	12	12x30°	
THT-63	730	690	-	-	-	-	-	-	-	630	674	-	-	-	-	-	-	640	350	650	12	12x30°	
THT-71	810	770	366	379	404	-	-	-	-	-	-	-	-	-	-	-	-	710	300	430	12	16x22°30'	
THT-71	810	770	-	-	-	438	433	-	-	-	-	-	-	-	-	-	-	710	300	500	12	16x22°30'	
THT-80	900	860	-	-	422	456	472	-	-	-	-	-	-	-	-	-	-	800	300	500	12	16x22°30'	
THT-80	900	860	-	-	-	-	-	515	-	-	-	-	-	-	-	-	-	800	300	600	12	16x22°30'	
THT-90	1015	970	-	-	-	466	482	525	565	590	-	-	-	-	-	-	-	900	350	600	15	16x22°30'	
THT-100	1115	1070	-	-	-	482	525	565	590	-	-	-	-	-	-	-	-	1000	450	600	15	16x22°30'	
THT-100	1115	1070	-	-	-	-	-	-	-	695	695	-	-	-	-	-	-	1000	450	700	15	16x22°30'	
THT-125	1365	1320	-	-	-	-	561	601	-	-	-	-	-	-	-	-	-	1250	500	700	15	20x18°	
THT-125	1365	1320	-	-	-	-	-	-	626	695	695	-	-	-	-	-	-	1250	500	700	15	20x18°	
THT-125	1365	1320	-	-	-	-	-	-	-	-	740	740	860	-	-	-	-	1250	500	900	15	20x18°	
THT-125	1365	1320	-	-	-	-	-	-	-	-	-	-	-	907	-	-	-	1250	500	1000	15	20x18°	
THT-125	1365	1320	-	-	-	-	-	-	-	-	-	-	-	-	987	-	-	1250	600	1000	15	20x18°	
THT-125	1365	1320	-	-	-	-	-	-	-	-	-	-	-	-	-	1077	-	1250	600	1200	15	20x18°	
THT-140	1515	1470	-	-	-	-	532	570	-	-	-	-	-	-	-	-	-	1400	400	650	15	20x18°	
THT-140	1515	1470	-	-	-	-	-	-	650	700	-	-	-	-	-	-	-	1400	450	700	15	20x18°	
THT-140	1515	1470	-	-	-	-	-	-	-	-	765	-	-	-	-	-	-	1400	550	900	15	20x18°	
THT-140	1515	1470	-	-	-	-	-	-	-	-	-	825	-	-	-	-	-	1400	550	900	15	20x18°	
THT-140	1515	1470	-	-	-	-	-	-	-	-	-	-	910	-	-	-	-	1400	550	1000	15	20x18°	
THT-140	1515	1470	-	-	-	-	-	-	-	-	-	-	-	985	-	-	-	1400	600	1000	15	20x18°	
THT-160	1735	1680	-	-	-	-	532	570	-	-	-	-	-	-	-	-	-	1600	400	650	19	24x15°	
THT-160	1735	1680	-	-	-	-	-	-	700	-	-	-	-	-	-	-	-	1600	450	700	19	24x15°	
THT-160	1735	1680	-	-	-	-	-	-	-	765	-	-	-	-	-	-	-	1600	550	900	19	24x15°	
THT-160	1735	1680	-	-	-	-	-	-	-	-	825	-	-	-	-	-	-	1600	550	1000	19	24x15°	
THT-160	1735	1680	-	-	-	-	-	-	-	-	-	910	-	-	-	-	-	1600	550	1000	19	24x15°	
THT-160	1735	1680	-	-	-	-	-	-	-	-	-	-	985	-	-	-	-	1600	600	1000	19	24x15°	
THT-160	1735	1680	-	-	-	-	-	-	-	-	-	-	-	-	1190	-	-	1600	700	1000	19	24x15°	

* Versión estándar suministrada en carcasa corta. Bajo demanda carcasa larga con trampilla de inspección.

Tamaños constructivos motores según potencia (1velocidad)

	CV																			
	0,75	1	1,5	2	3	4	5,5	7,5	10	12	15	20	22	25	30	40	50	60	75	100
2T (3000 r/min)	80	80	80	90S	90L	100LB	112M	132S	132S	132MA	160M	160M	160L	180M	180L	200L	225S/M	225S/M	250S/M	280S/M
4T (1500 r/min)	90S	90S	90S	90L	100LA	100LB	112M	132S	132M	-	160M	160L	-	180M	180L	200L	225S/M	225S/M	250S/M	280S/M
6T (1000 r/min)	90S	90S	90L	100L	112M	132S	132MA	132MB	160M	-	160L	180L	-	200MLA	200MLB	225SMB	250S/M	280S/M	280S/M	-
8T (750 r/min)	90L	100LA	100L	112M	132S	132M	160MA	160M	160L	-	180L	200MLA	-	225SMA	225SMB	250SMA	280S/M	280S/M	-	-

Tamaños constructivos motores según potencia (2velocidad)

	CV																						
	0,75	1	1,5	2	3	4	5,5	6	7,5	8	9	10	12	15	18	20	22	24	27	37	38	40	
2/4(3000/1500 r/min)	-	-	90S	90S	90L	100L	-	112M	-	-	132M	-	160MA	-	160M	-	160L	-	-	-	-	-	-
4/8(1500/750 r/min)	-	-	90S	100L	100LA	100LC	132S	-	132S	132S	-	132M	-	160M	-	160L	180M	180L	200MLA	200L	225S/M	-	
6/12(1000/500 r/min)	90L	100L	100LB	112M	112M	132MC	160M	160M	160LB	160LB	-	160LB	-	200MLC	160L	200M	-	250SMB	22S/M	-	225S/M	-	

EJEMPLO SELECCIÓN

Curvas características

THT CJTHT

Q= Caudal en m³/h, m³/s y cfm.Pe= Presión estática en mmH₂O, Pa e inwg.

Diámetro Hélice (cm): 71

Número de polos: 6

Número de palas: 6

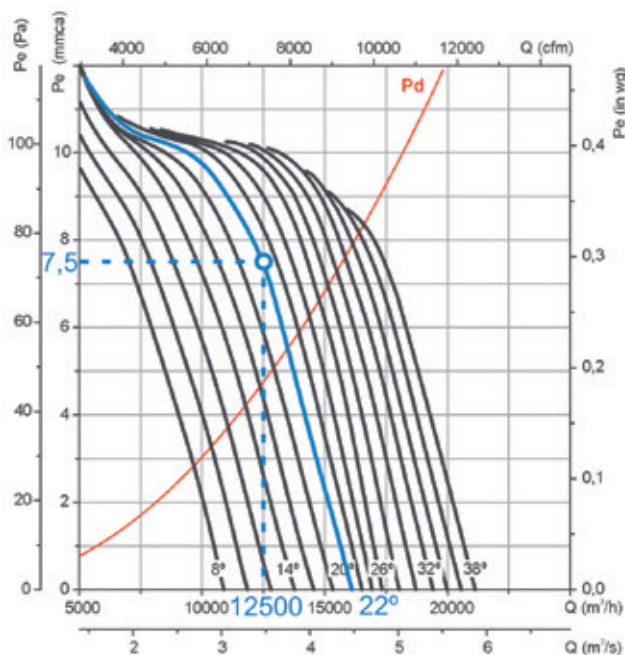

Datos de partida

- Punto de trabajo:
- Caudal: 12.500 m³/h
- Pérdida de carga: 7,5 mm c.a.

Pasos para la selección del equipo

En la gráfica de presiones:

1. Marcar el punto de trabajo, definido por el caudal de trabajo (12.500 m³/h) y la pérdida de carga (7,5 mmH₂O).
2. Escoger la curva del equipo que más se acerque por encima al punto de trabajo. En nuestro caso se obtiene una curva de 22° de ángulo de pala.

En la gráfica de potencia:

3. Marcar el punto de trabajo, definido por el caudal de trabajo (12.500 m³/h) y la curva de ángulo de pala escogido (22°).
4. Leer la potencia absorbida en el eje de potencias a la izquierda. La Pa= 560 W en el punto de trabajo.
5. Buscar recta roja que más se acerque al punto de trabajo por encima. En la parte derecha de la gráfica se obtiene el valor de potencia instalada de motor. En nuestro caso 0,75 kW o 1 CV.

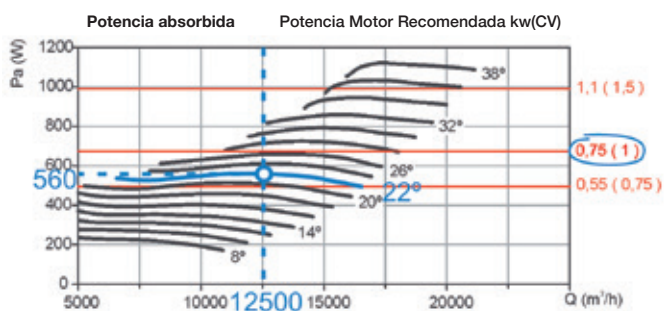

EJEMPLO CÓDIGO PEDIDO

	THT	40	4T	2	6-20	F-400
Nombre de serie:	THT	CJTHT				
Diámetro hélice en cm.						
Número de polos motor						
T=Trifásico M=Monofásico						
Potencia motor (c.v.)						
Número de palas						
Angulo inclinación palas						
F-300: Homologación 300°C/2h F-400: Homologación 400°C/2h CAT3: Con certificación ATEX Categoría 3 Ex II/3G						

Curvas características

Q= Caudal en m³/h, m³/s y cfm.

Pe= Presión estática en mmH₂O, Pa e inwg.

Diámetro Hélice (cm): 40

Número de polos: 2

Número de palas: 6

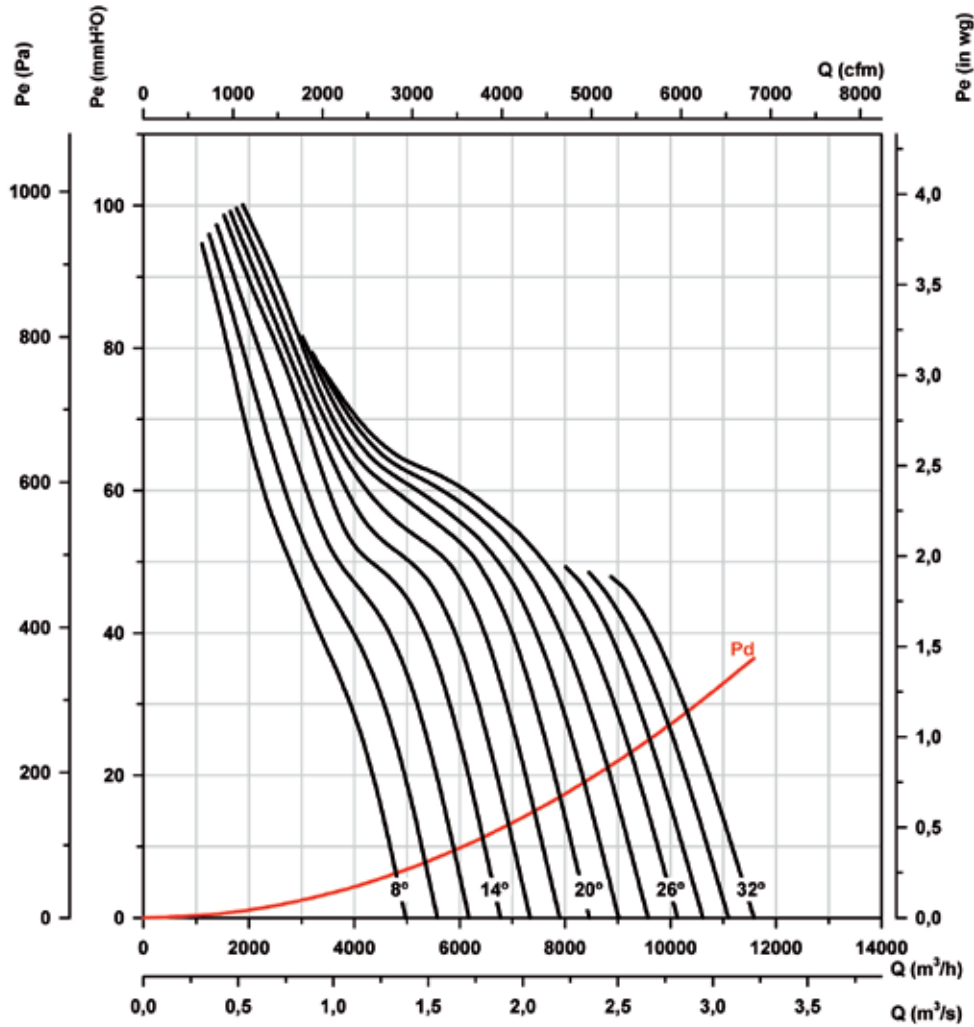

Potencia absorbida

Potencia Motor Recomendada kw(CV)

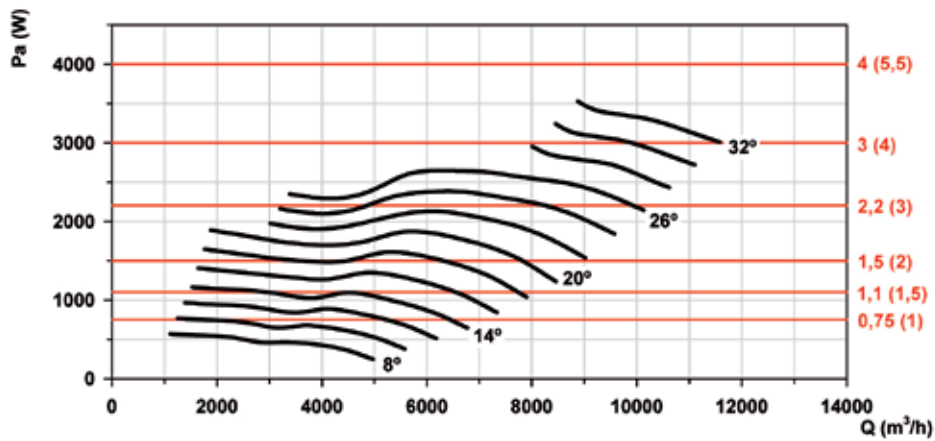

Curvas características

Q= Caudal en m³/h, m³/s y cfm.

Pe= Presión estática en mmH²O, Pa e inwg.

Diámetro Hélice (cm): 40

Número de polos: 4

Número de palas: 6

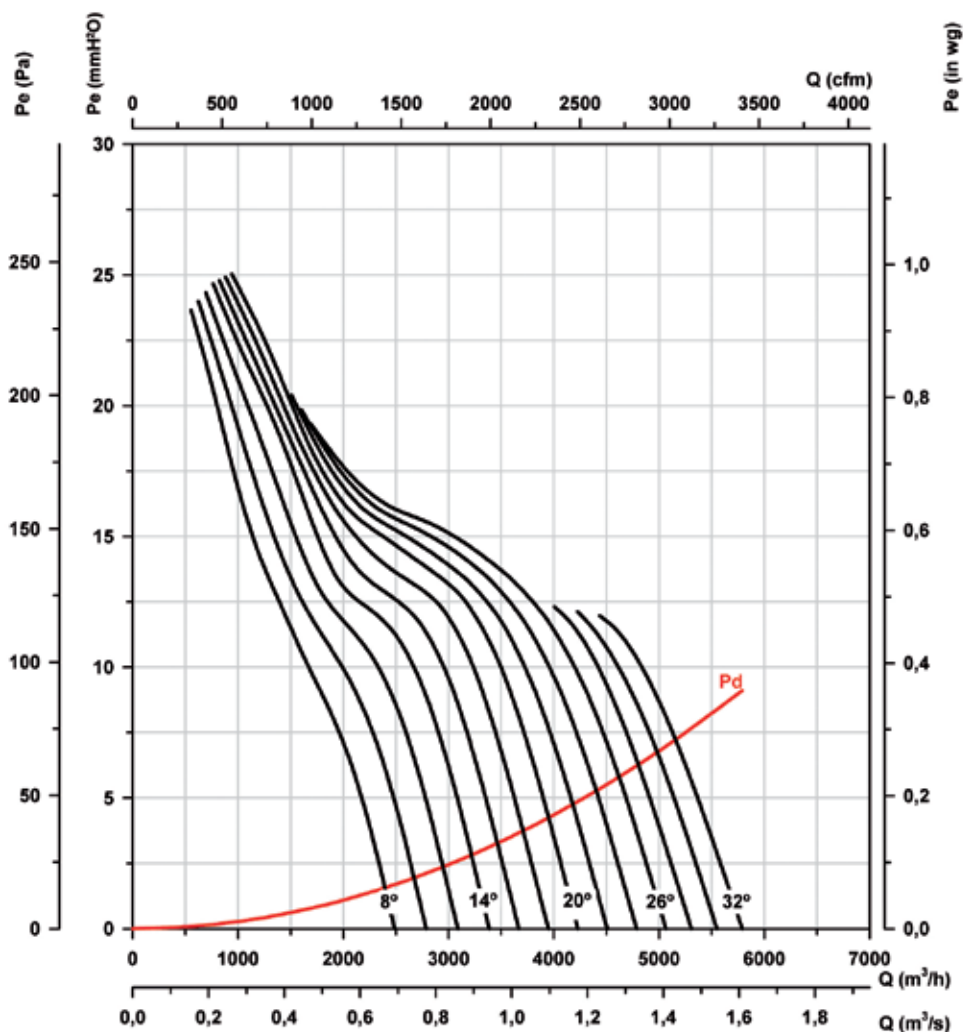

Potencia absorbida

Potencia Motor Recomendada kw(CV)

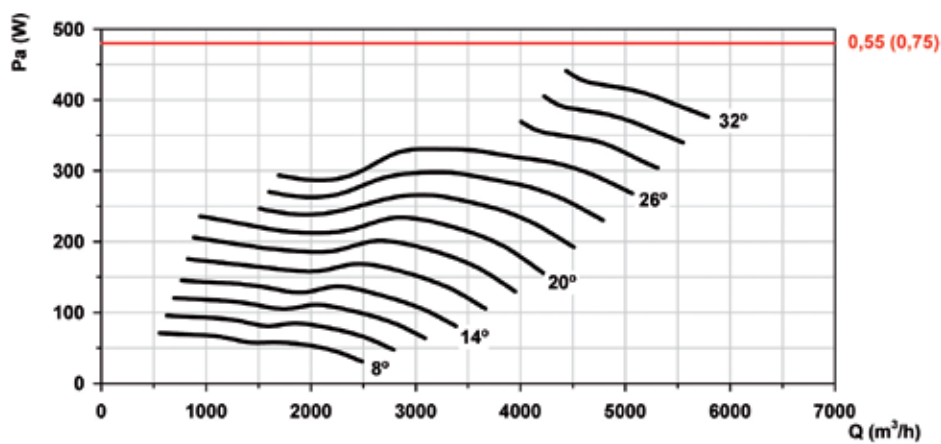

Curvas características

Q= Caudal en m³/h, m³/s y cfm.

Pe= Presión estática en mmH₂O, Pa e inwg.

Diámetro Hélice (cm): 40

Número de polos: 6

Número de palas: 6

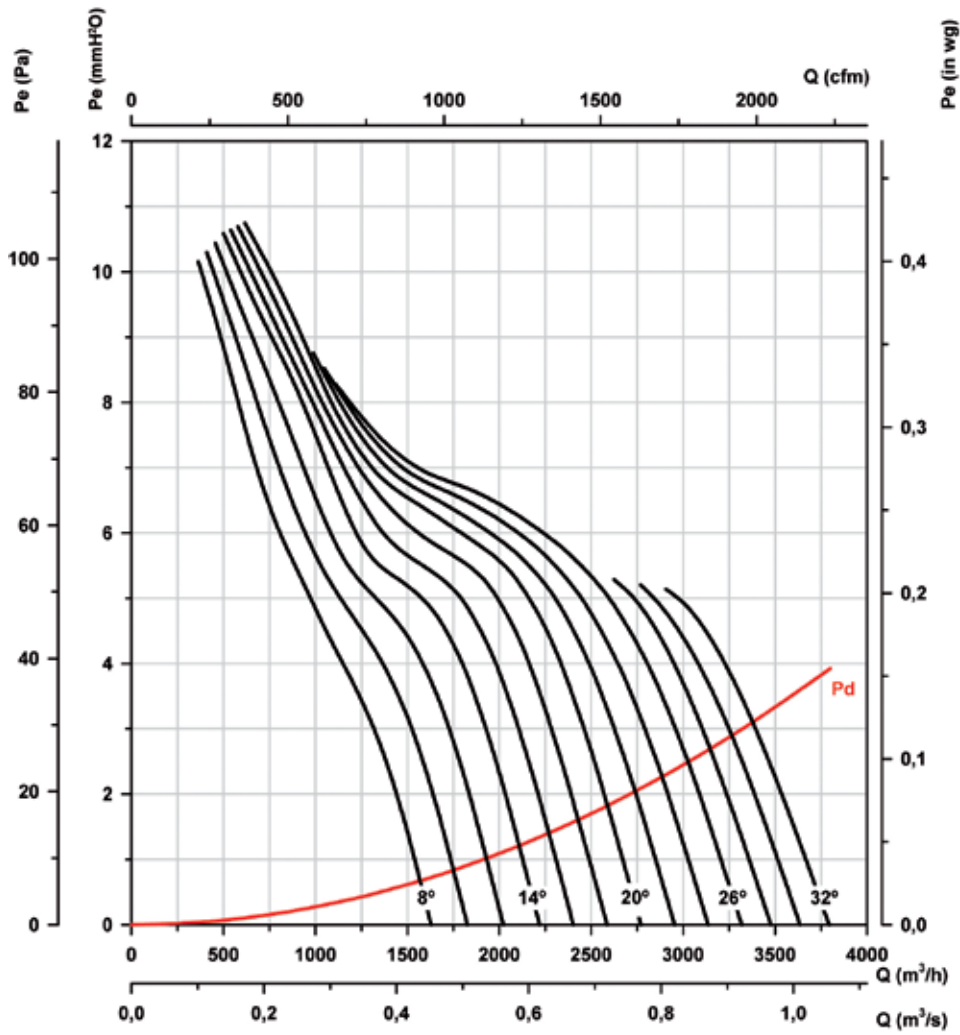

Potencia absorbida

Potencia Motor Recomendada kw(CV)

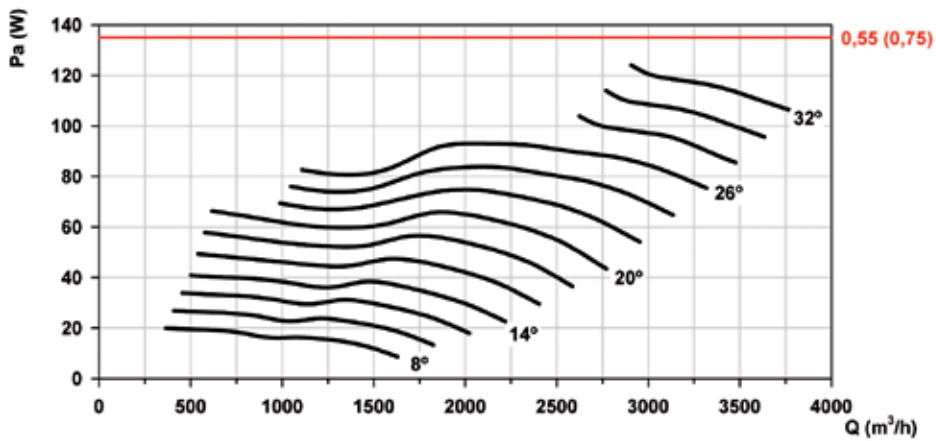

Curvas características

Q= Caudal en m³/h, m³/s y cfm.

Pe= Presión estática en mmH₂O, Pa e inwg.

Diámetro Hélice (cm): 45

Número de polos: 2

Número de palas: 6

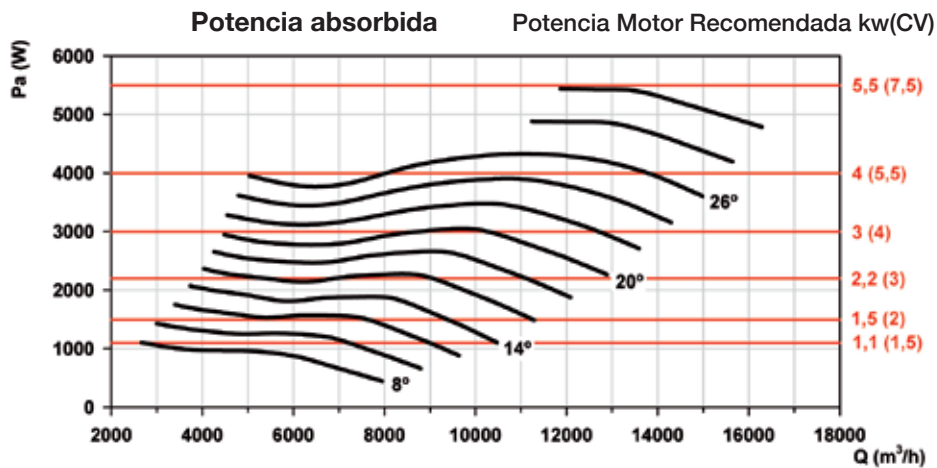
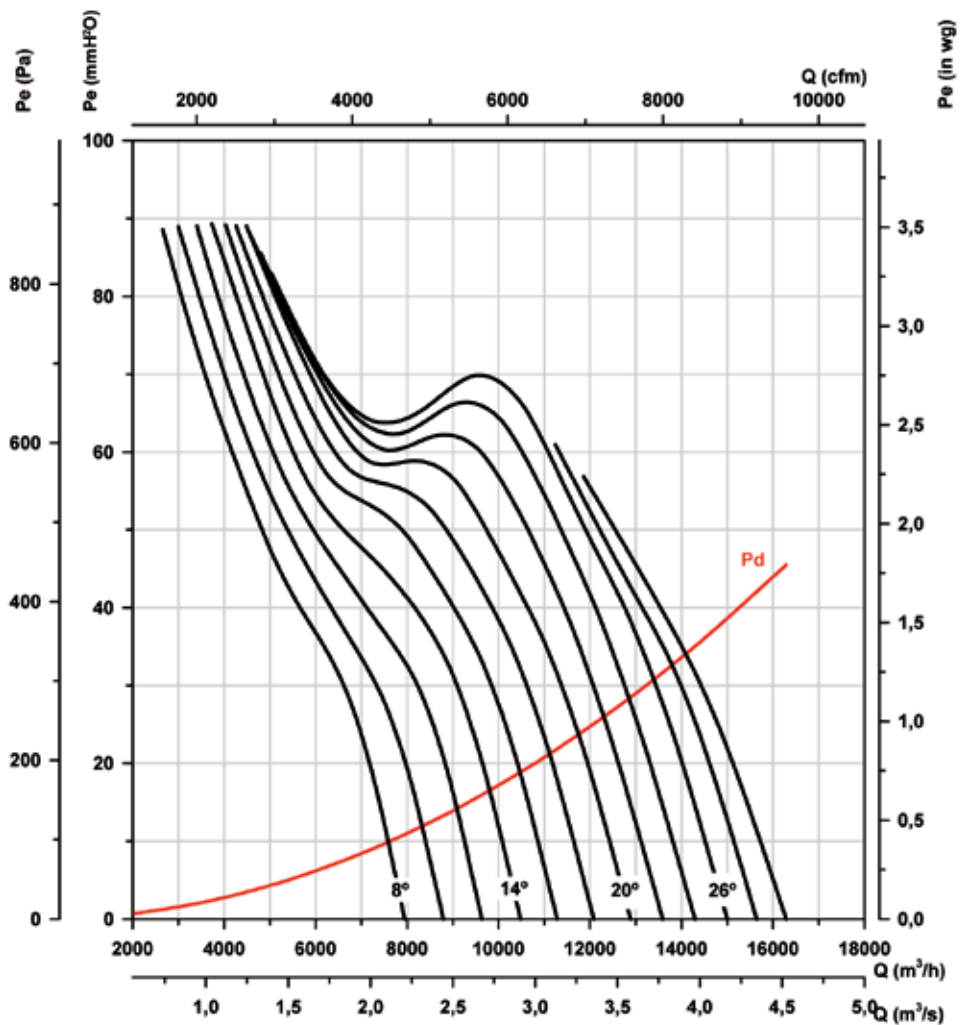

Curvas características

Q= Caudal en m³/h, m³/s y cfm.

Pe= Presión estática en mmH₂O, Pa e inwg.

Diámetro Hélice (cm): 45

Número de polos: 4

Número de palas: 6

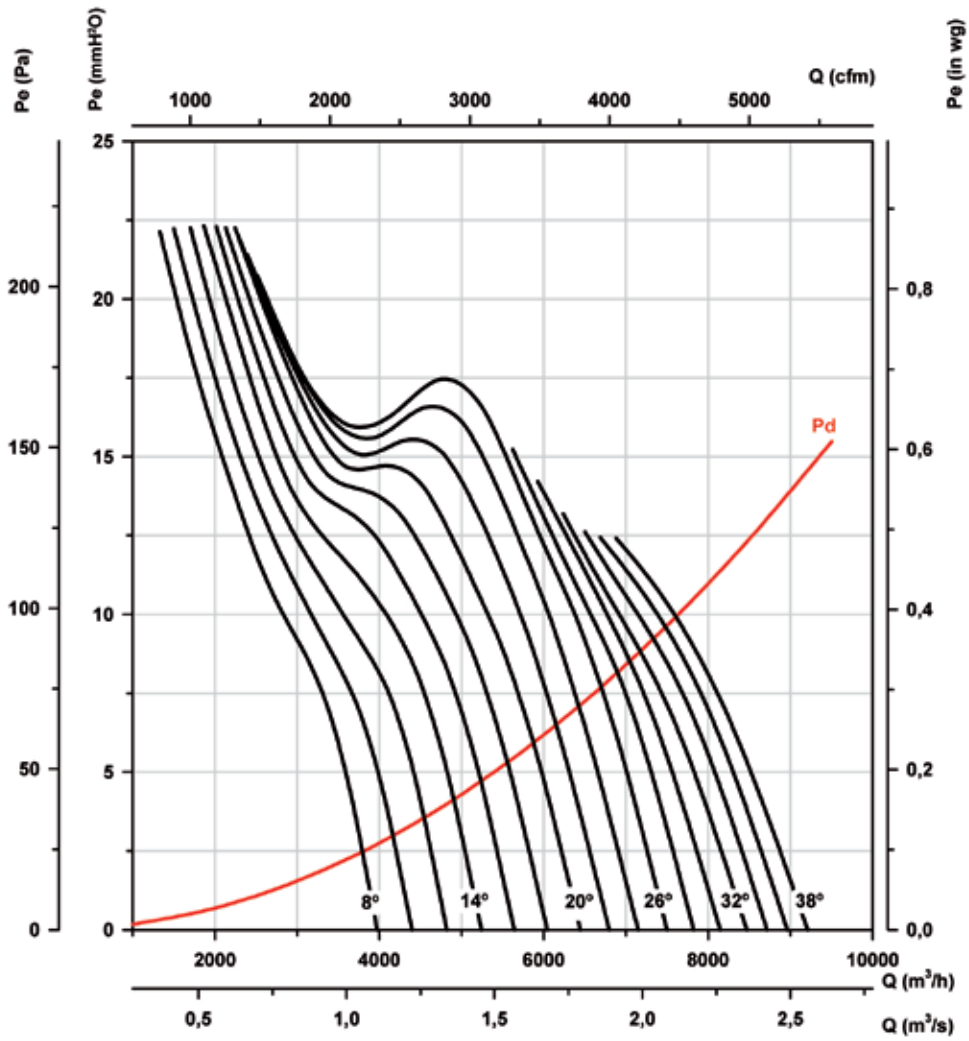

Potencia absorbida

Potencia Motor Recomendada kw(CV)

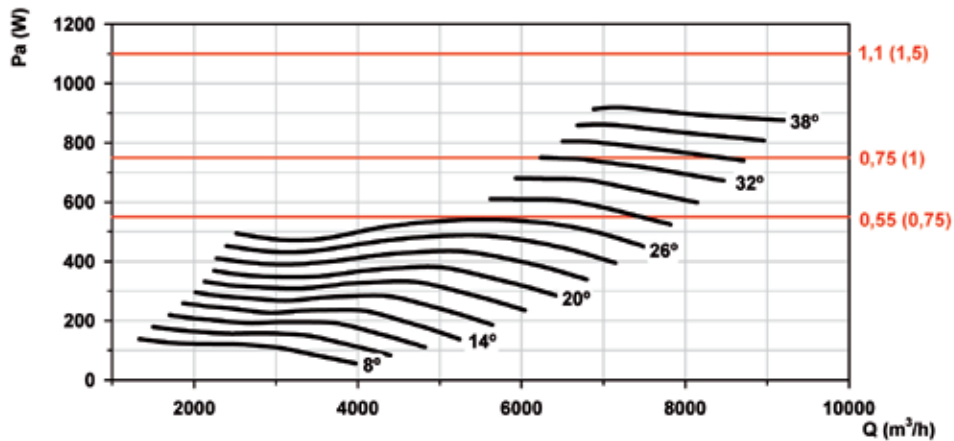

Curvas características

Q= Caudal en m³/h, m³/s y cfm.

Pe= Presión estática en mmH²O, Pa e inwg.

Diámetro Hélice (cm): 45

Número de polos: 6

Número de palas: 8

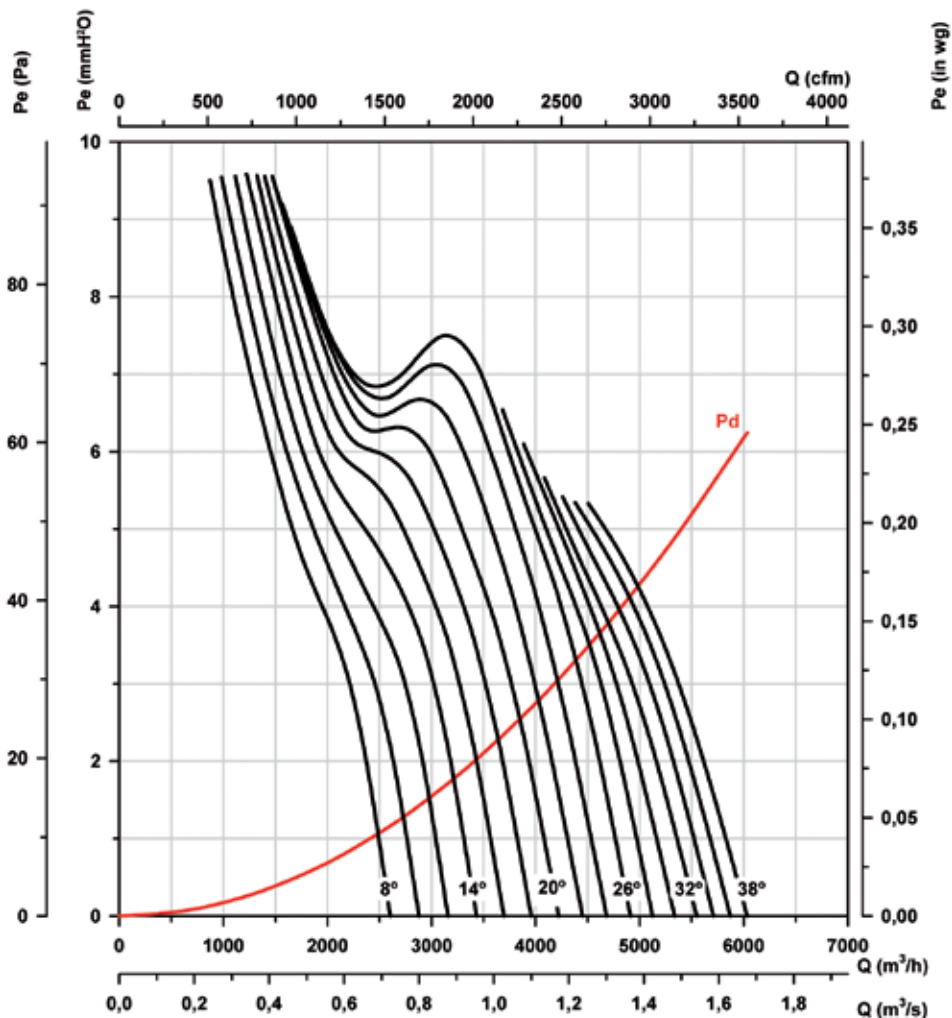

Potencia absorbida

Potencia Motor Recomendada kw(CV)

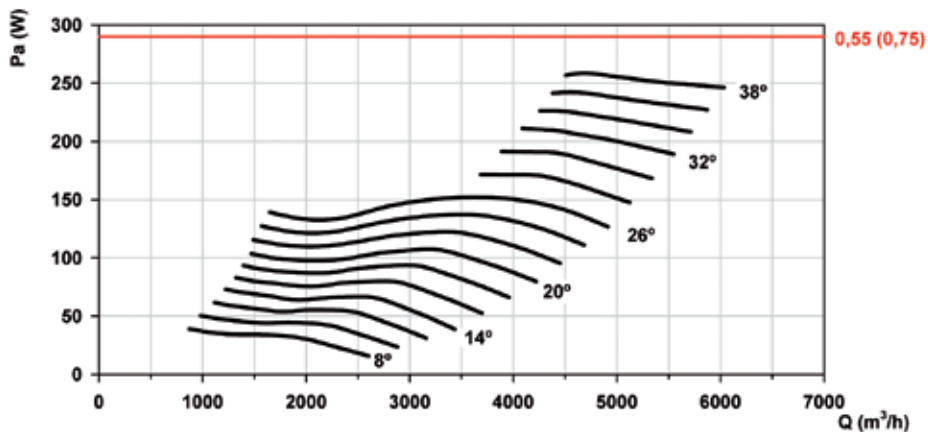

Curvas características

Q= Caudal en m³/h, m³/s y cfm.

Pe= Presión estática en mmH₂O, Pa e inwg.

Diámetro Hélice (cm): 50

Número de polos: 2

Número de palas: 6

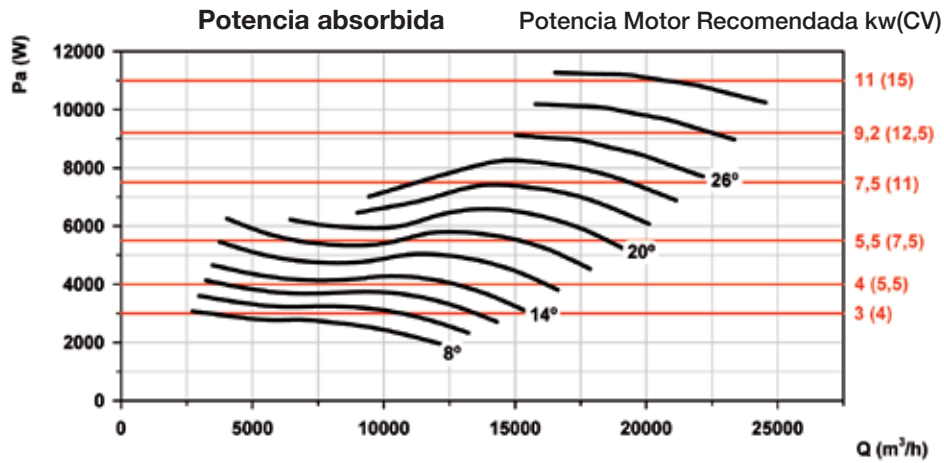
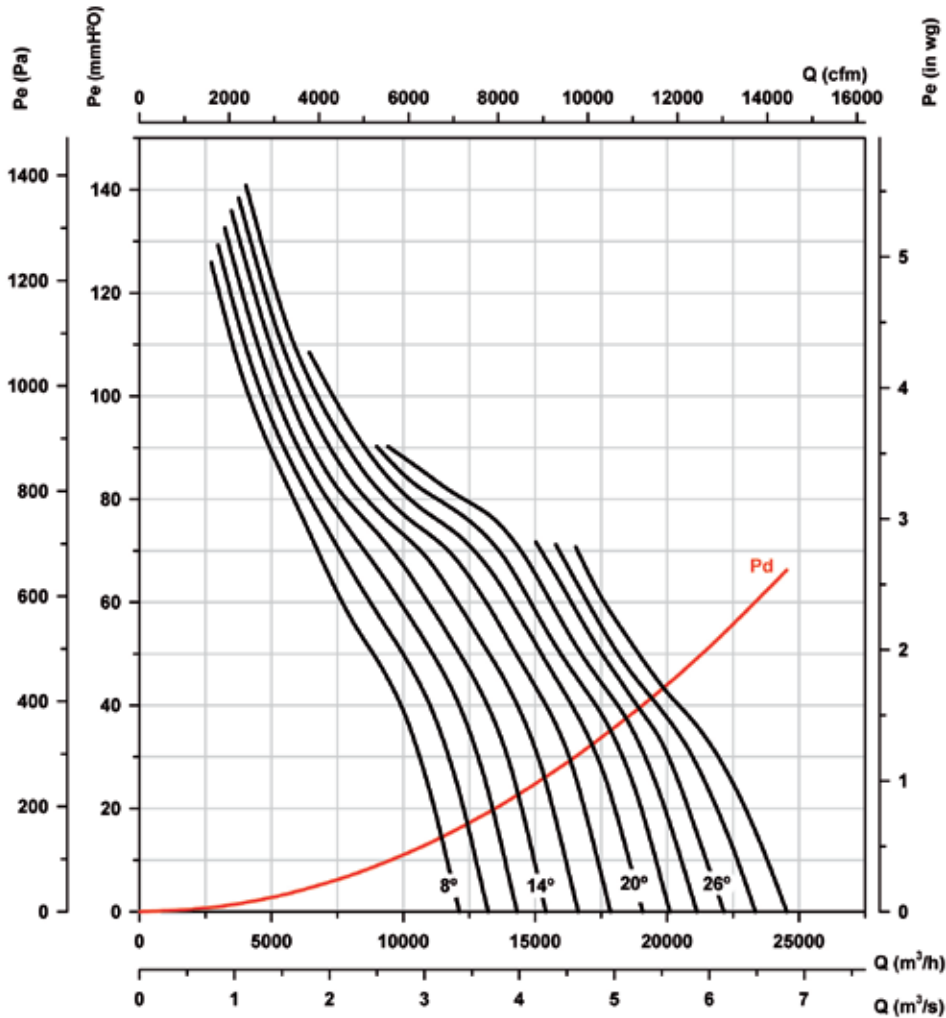

Curvas características

Q= Caudal en m³/h, m³/s y cfm.

Pe= Presión estática en mmH²O, Pa e inwg.

Diámetro Hélice (cm): 50

Número de polos: 4

Número de palas: 6

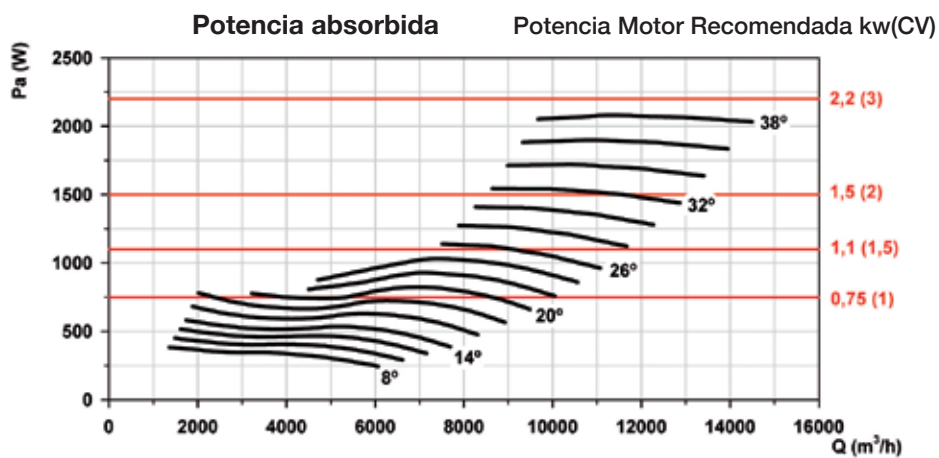
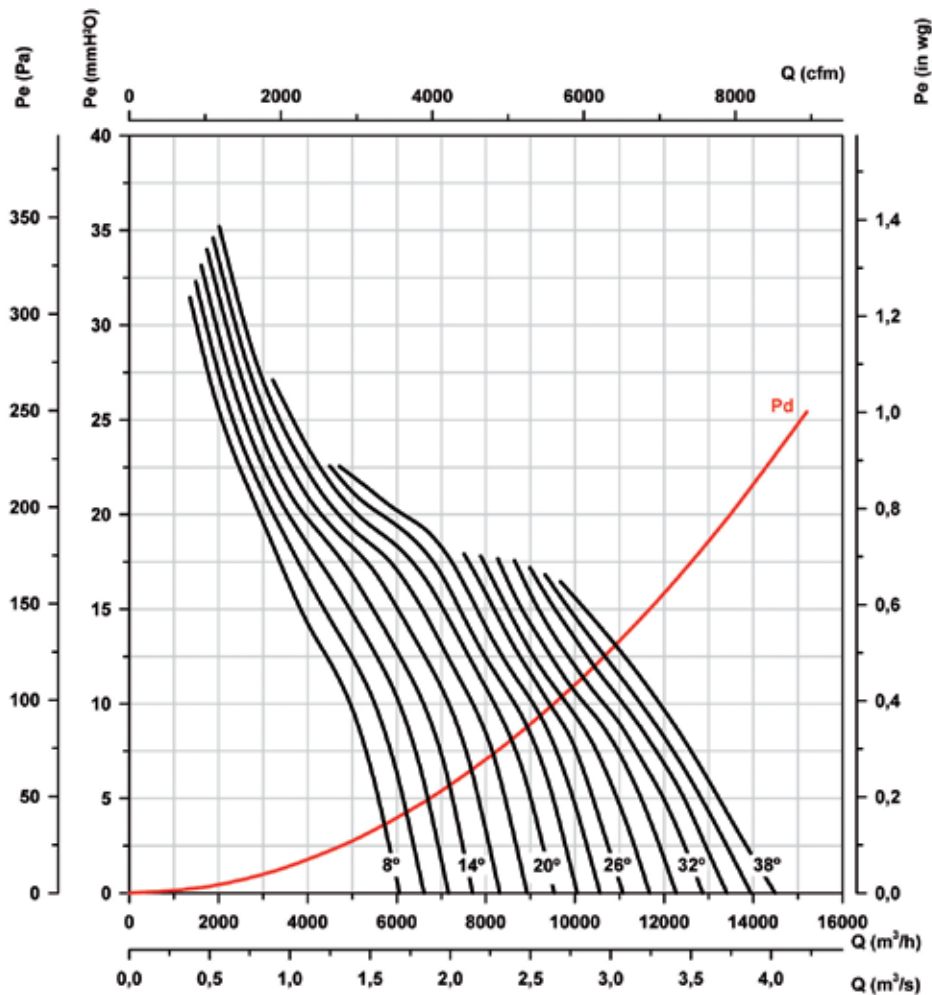

Curvas características

Q= Caudal en m³/h, m³/s y cfm.

Pe= Presión estática en mmH₂O, Pa e inwg.

Diámetro Hélice (cm): 50

Número de polos: 6

Número de palas: 6

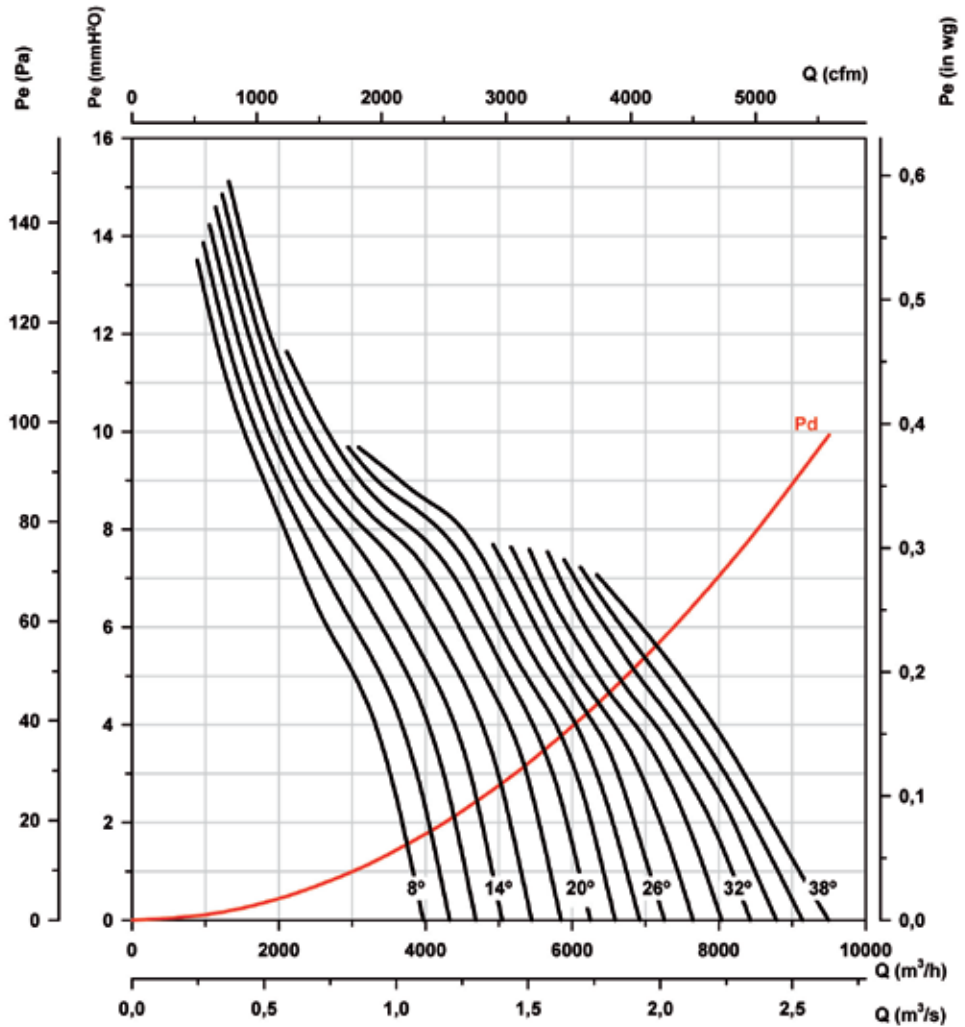

Potencia absorbida

Potencia Motor Recomendada kw(CV)

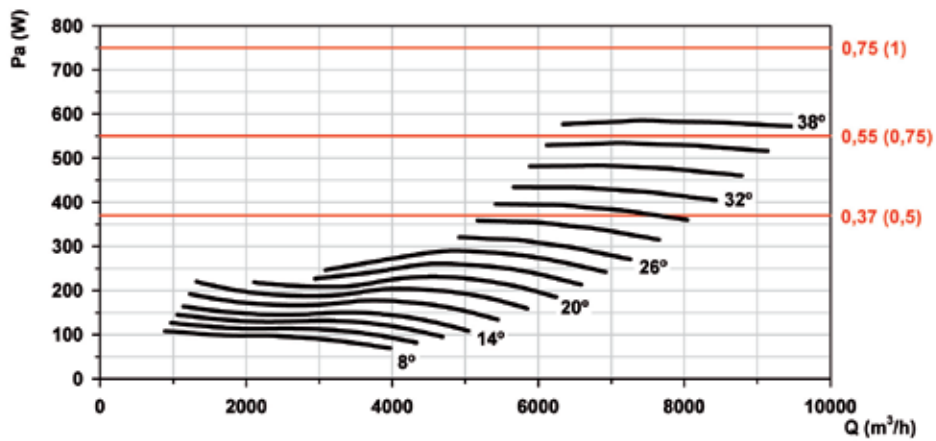

Curvas características

Q= Caudal en m³/h, m³/s y cfm.

Pe= Presión estática en mmH²O, Pa e inwg.

Diámetro Hélice (cm): 56

Número de polos: 2

Número de palas: 6

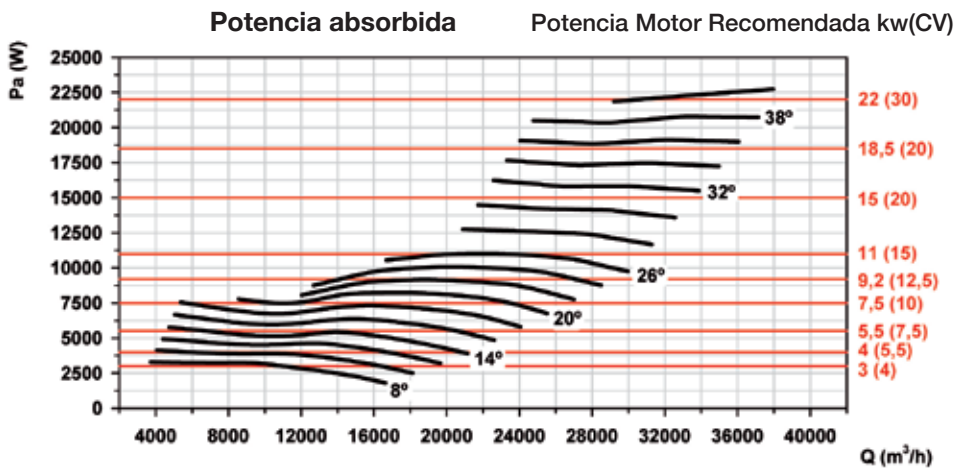
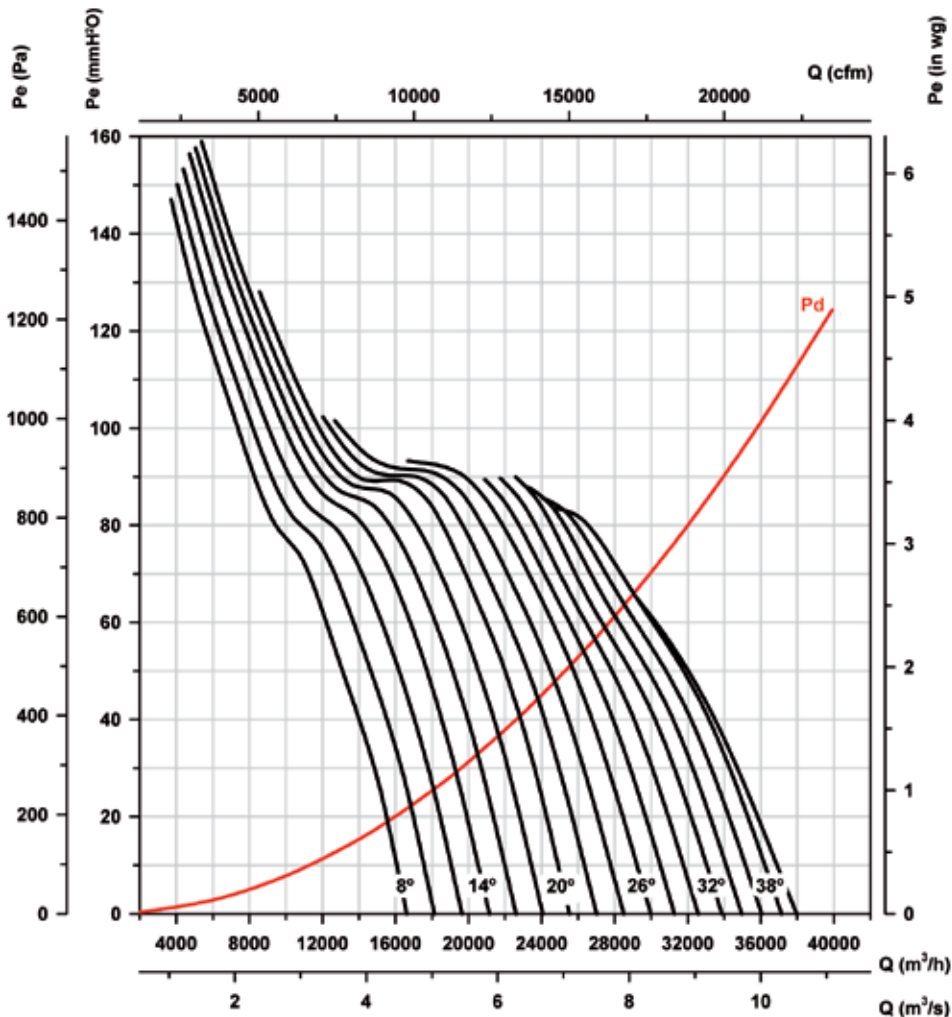

Curvas características

Q= Caudal en m³/h, m³/s y cfm.

Pe= Presión estática en mmH₂O, Pa e inwg.

Diámetro Hélice (cm): 56

Número de polos: 4

Número de palas: 6

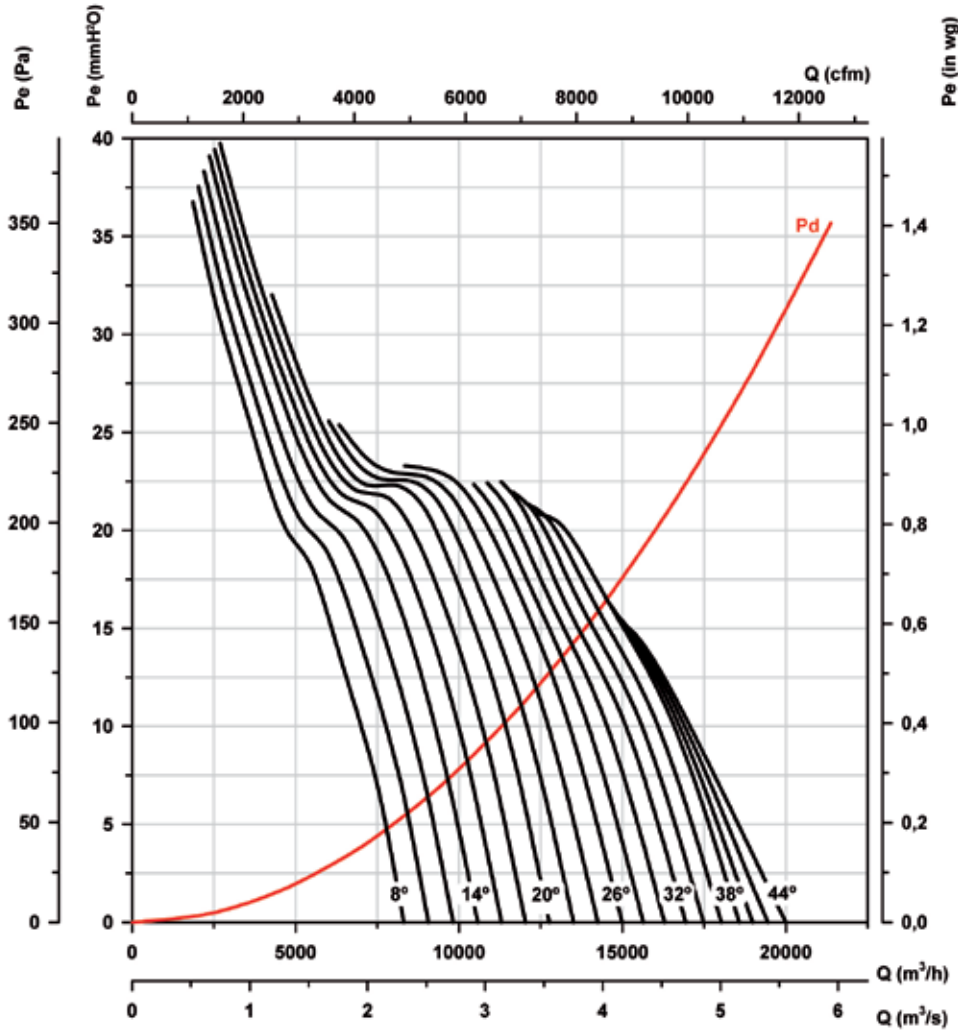

Potencia absorbida

Potencia Motor Recomendada kw(CV)

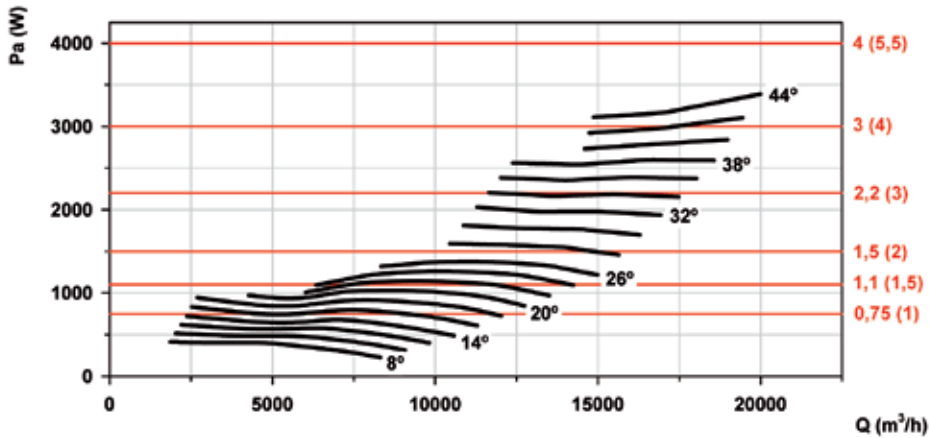

Curvas características

Q= Caudal en m³/h, m³/s y cfm.

Pe= Presión estática en mmH²O, Pa e inwg.

Diámetro Hélice (cm): 56

Número de polos: 6

Número de palas: 6

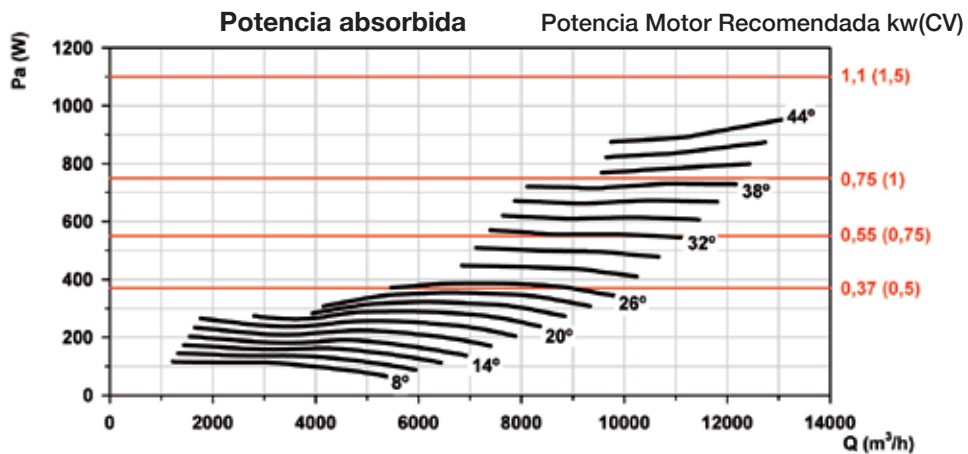
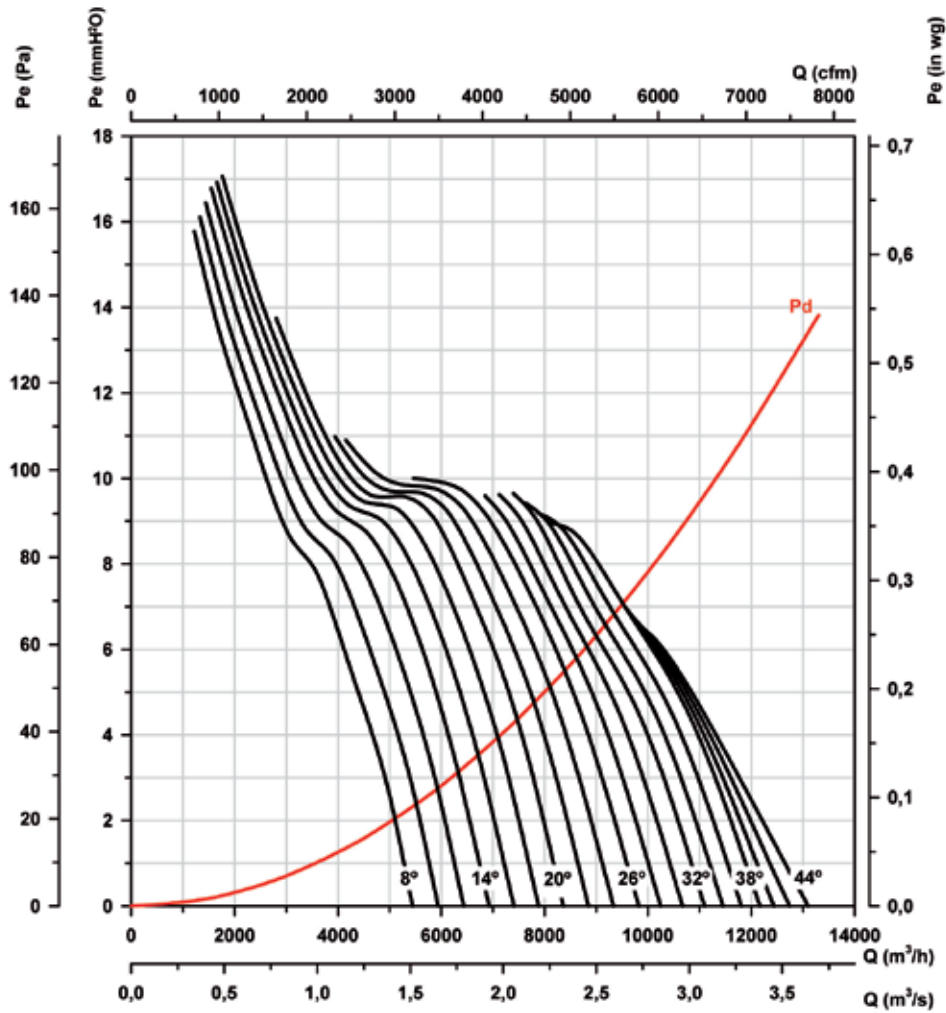

Curvas características

Q= Caudal en m³/h, m³/s y cfm.

Pe= Presión estática en mmH₂O, Pa e inwg.

Diámetro Hélice (cm): 63

Número de polos: 2

Número de palas: 6

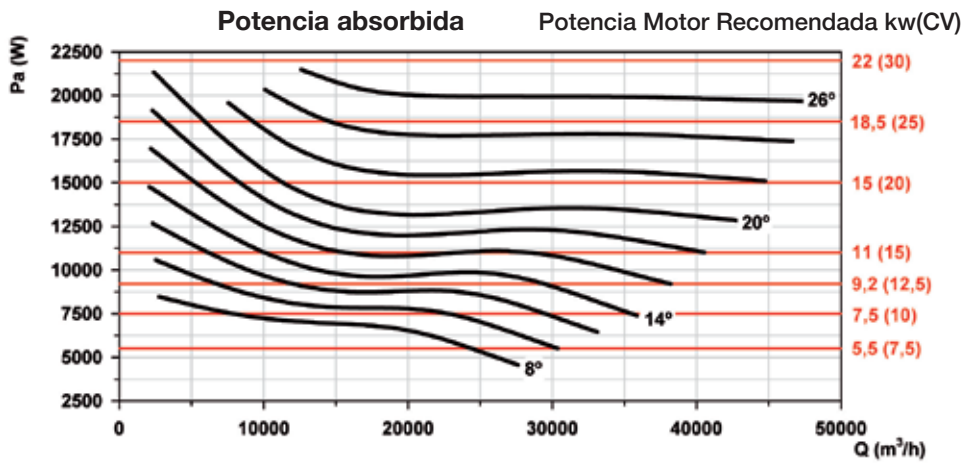
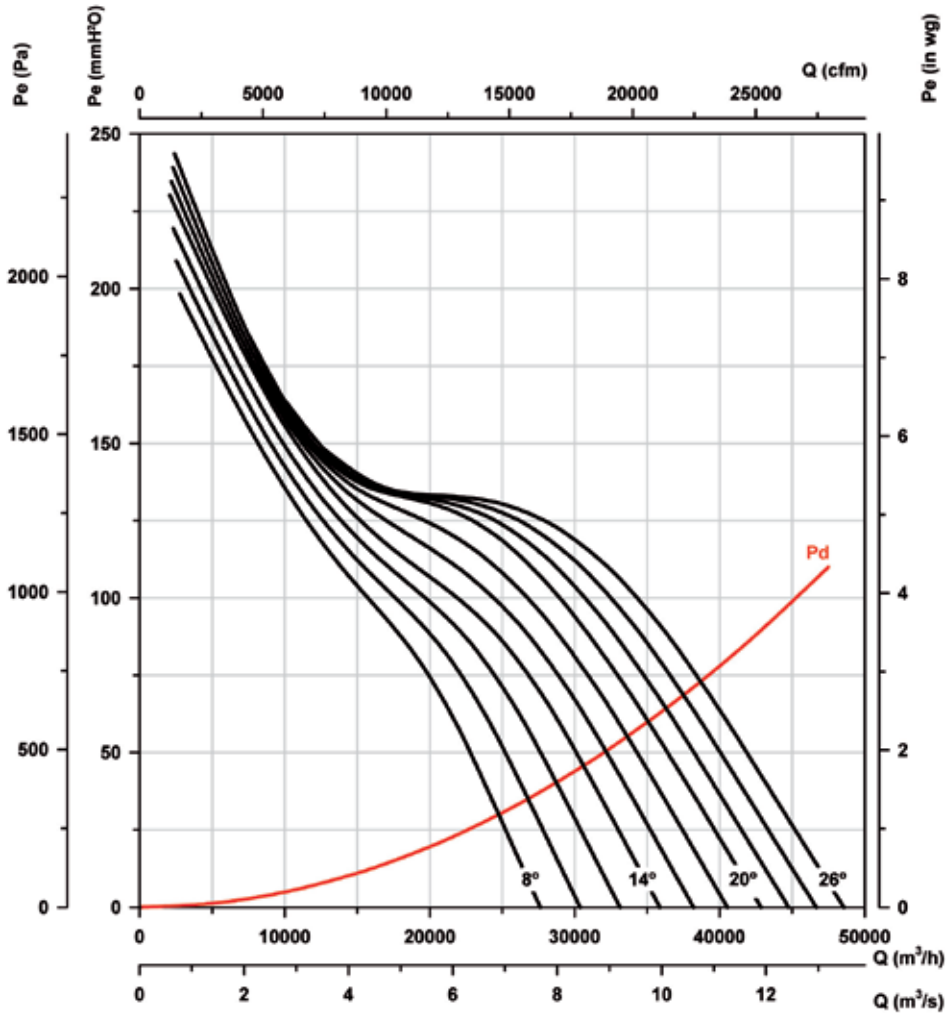

Curvas características

Q= Caudal en m³/h, m³/s y cfm.

Pe= Presión estática en mmH²O, Pa e inwg.

Diámetro Hélice (cm): 63

Número de polos: 4

Número de palas: 6

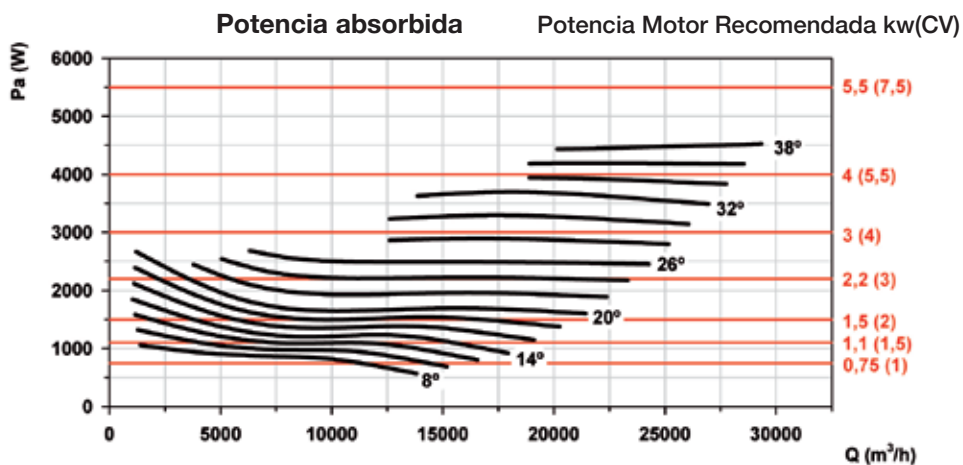
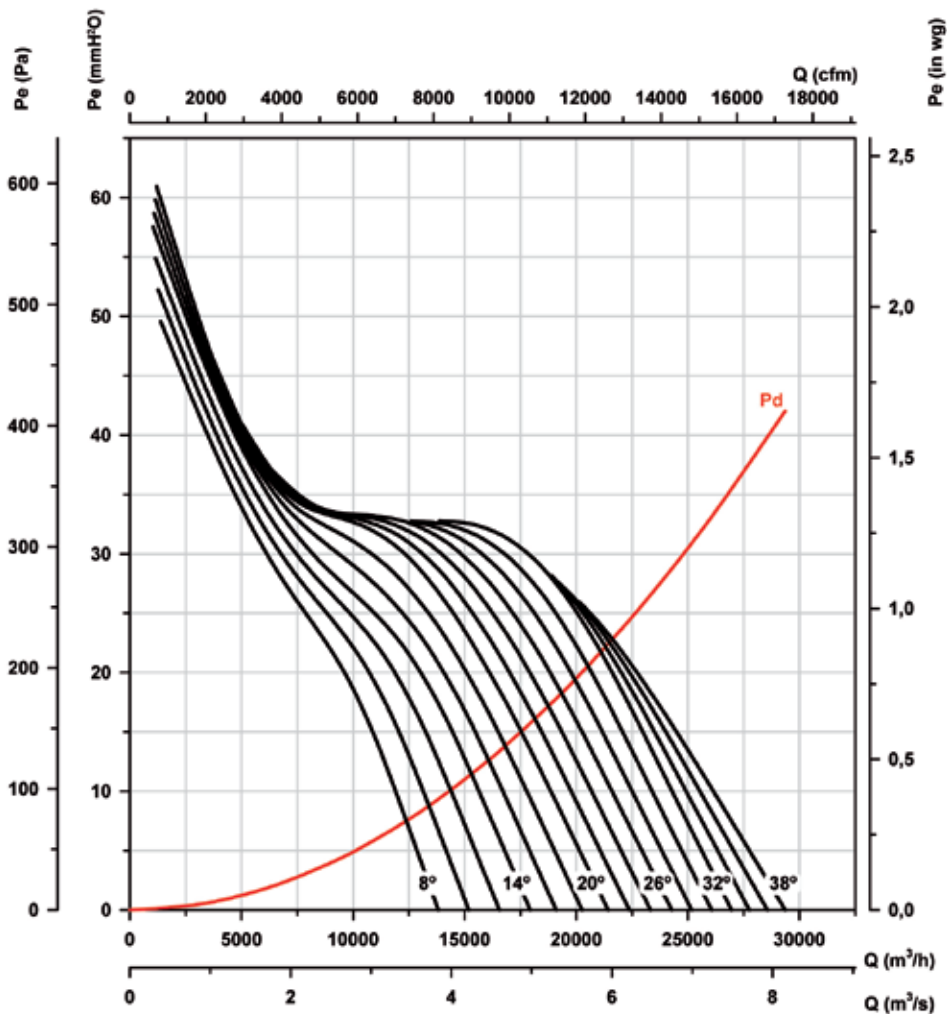

Curvas características

Q= Caudal en m³/h, m³/s y cfm.

Pe= Presión estática en mmH²O, Pa e inwg.

Diámetro Hélice (cm): 63

Número de polos: 6

Número de palas: 6

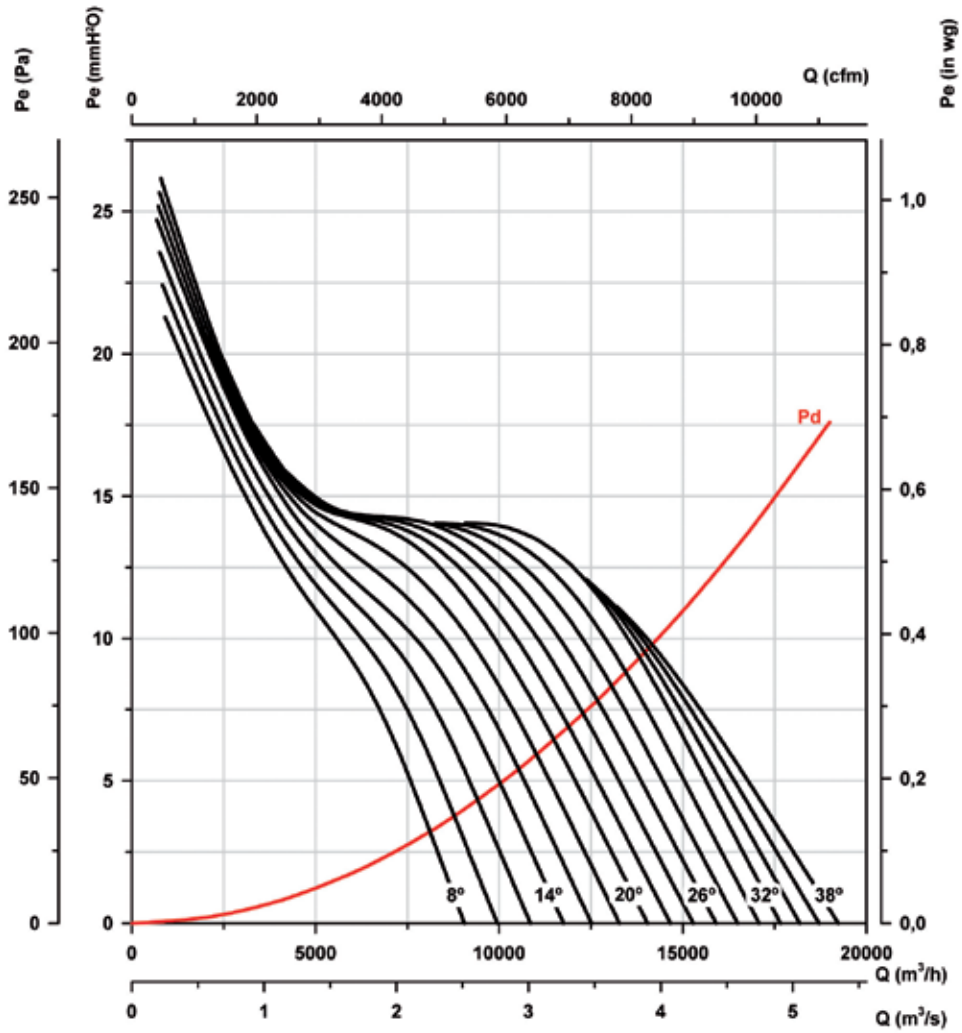

Potencia absorbida

Potencia Motor Recomendada kw(CV)

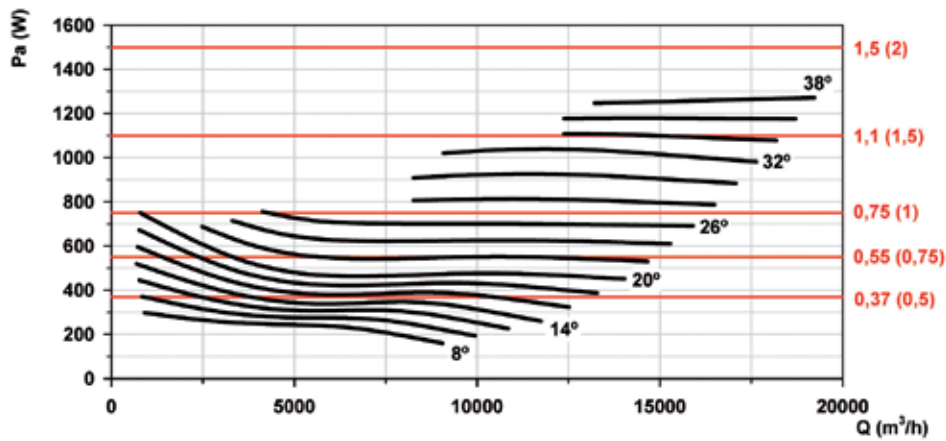

Curvas características

Q= Caudal en m³/h, m³/s y cfm.

Pe= Presión estática en mmH²O, Pa e inwg.

Diámetro Hélice (cm): 71

Número de polos: 4

Número de palas: 6

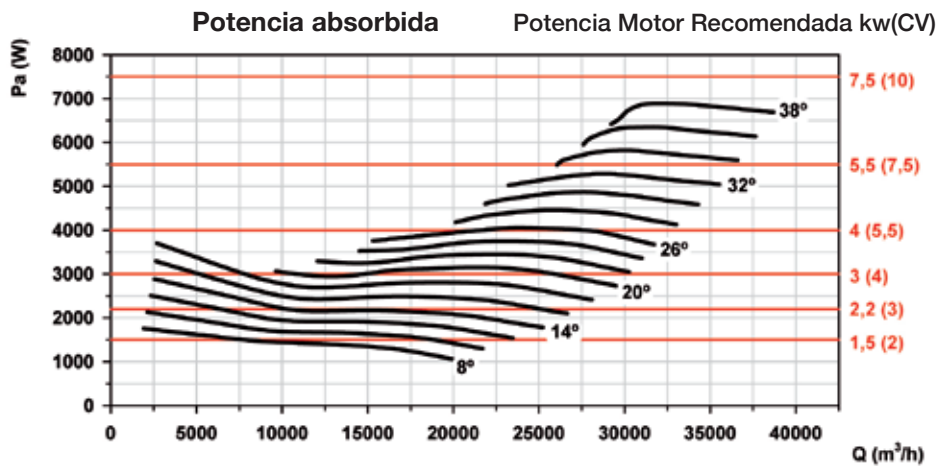
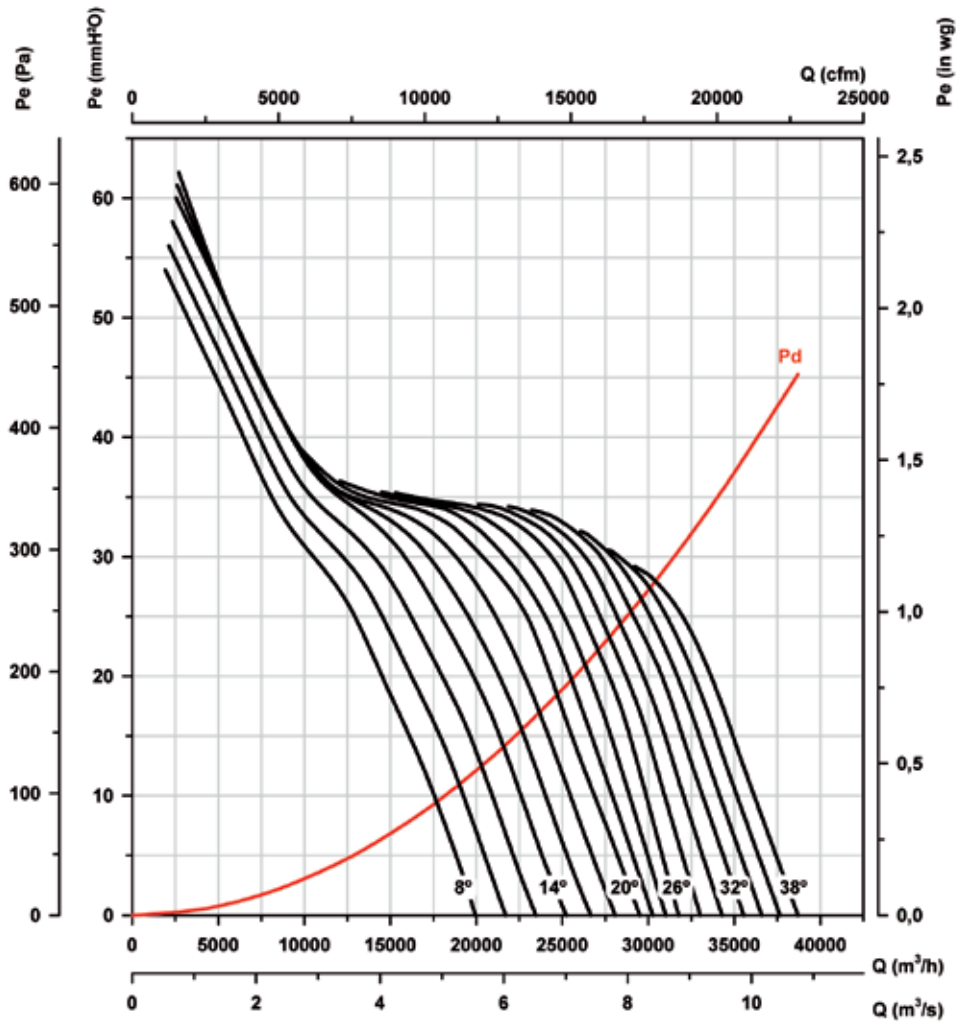

Curvas características

Q= Caudal en m³/h, m³/s y cfm.

Pe= Presión estática en mmH²O, Pa e inwg.

Diámetro Hélice (cm): 71

Número de polos: 6

Número de palas: 6

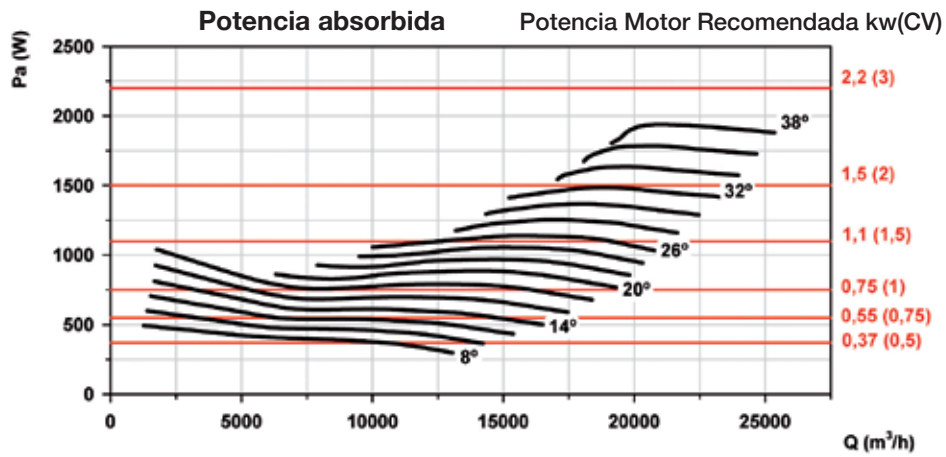
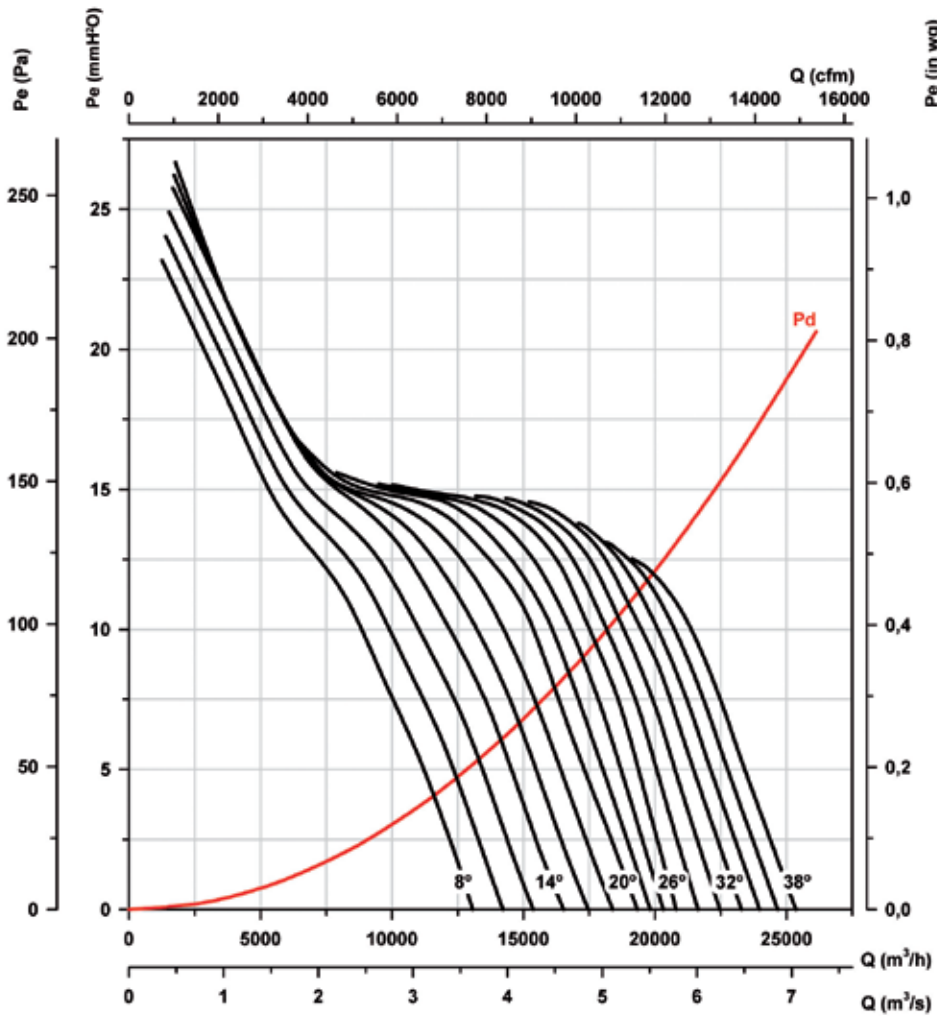

Curvas características

Q= Caudal en m³/h, m³/s y cfm.

Pe= Presión estática en mmH²O, Pa e inwg.

Diámetro Hélice (cm): 80

Número de polos: 4

Número de palas: 6

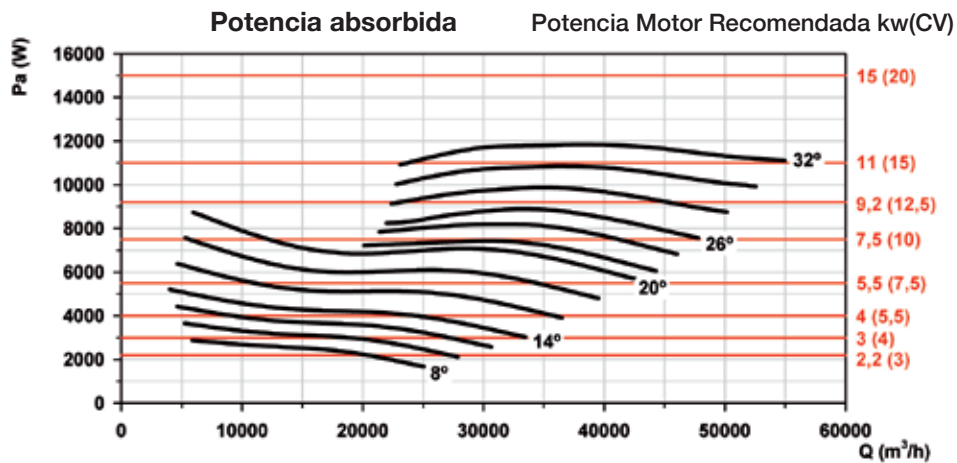
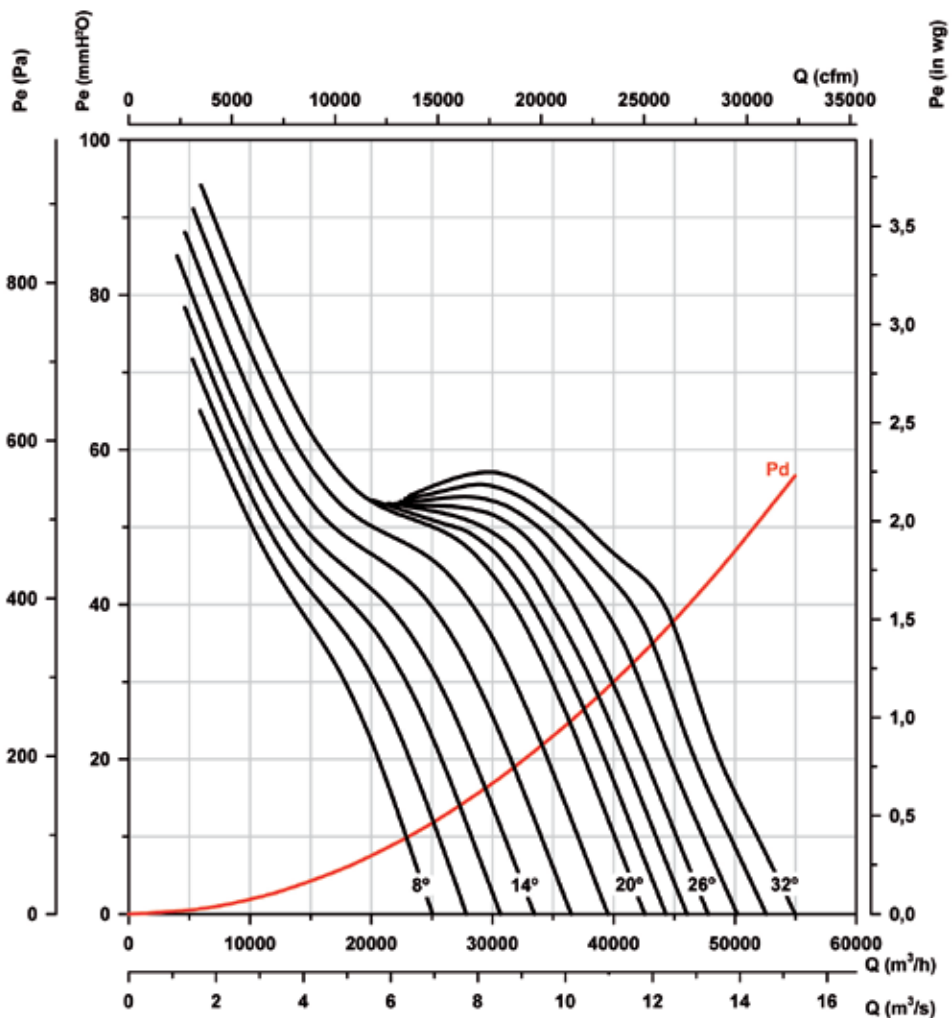

Curvas características

Q= Caudal en m³/h, m³/s y cfm. Pe= Presión estática en mmH₂O, Pa e inwg.

Diámetro Hélice (cm): 80

Número de polos: 6

Número de palas: 6

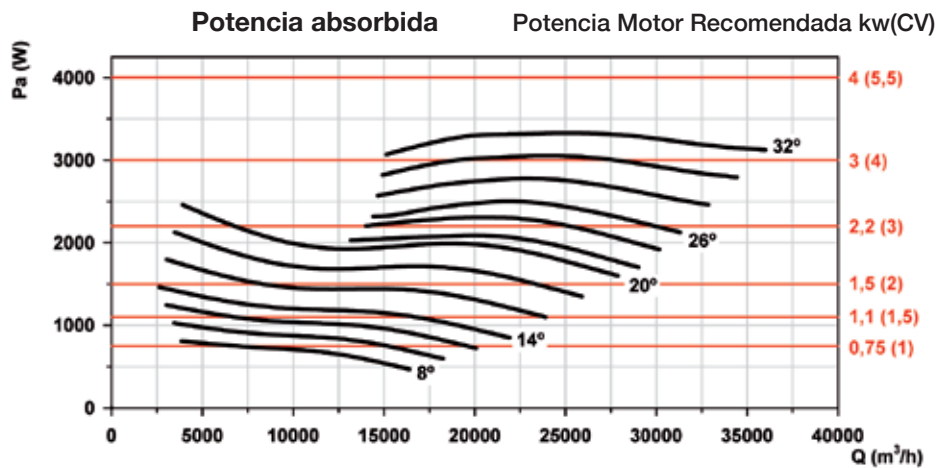
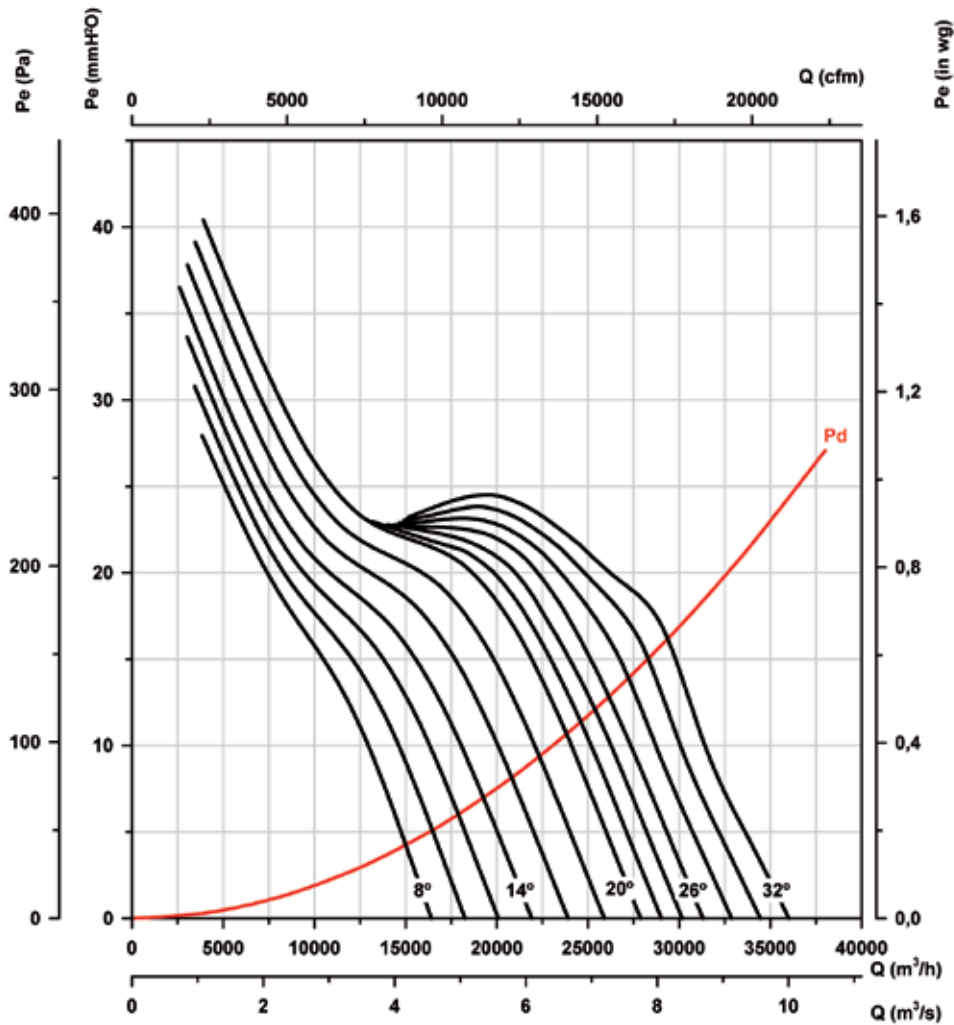

Curvas características

Q= Caudal en m³/h, m³/s y cfm.

Pe= Presión estática en mmH²O, Pa e inwg.

Diámetro Hélice (cm): 80

Número de polos: 8

Número de palas: 6

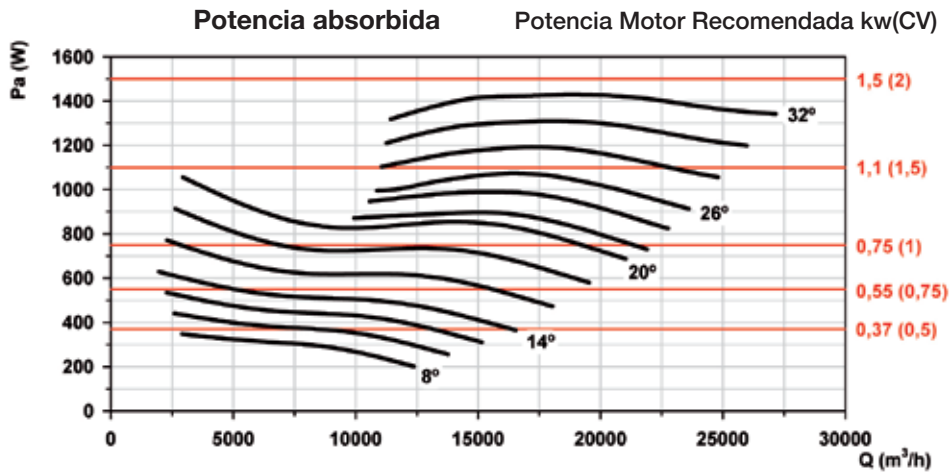
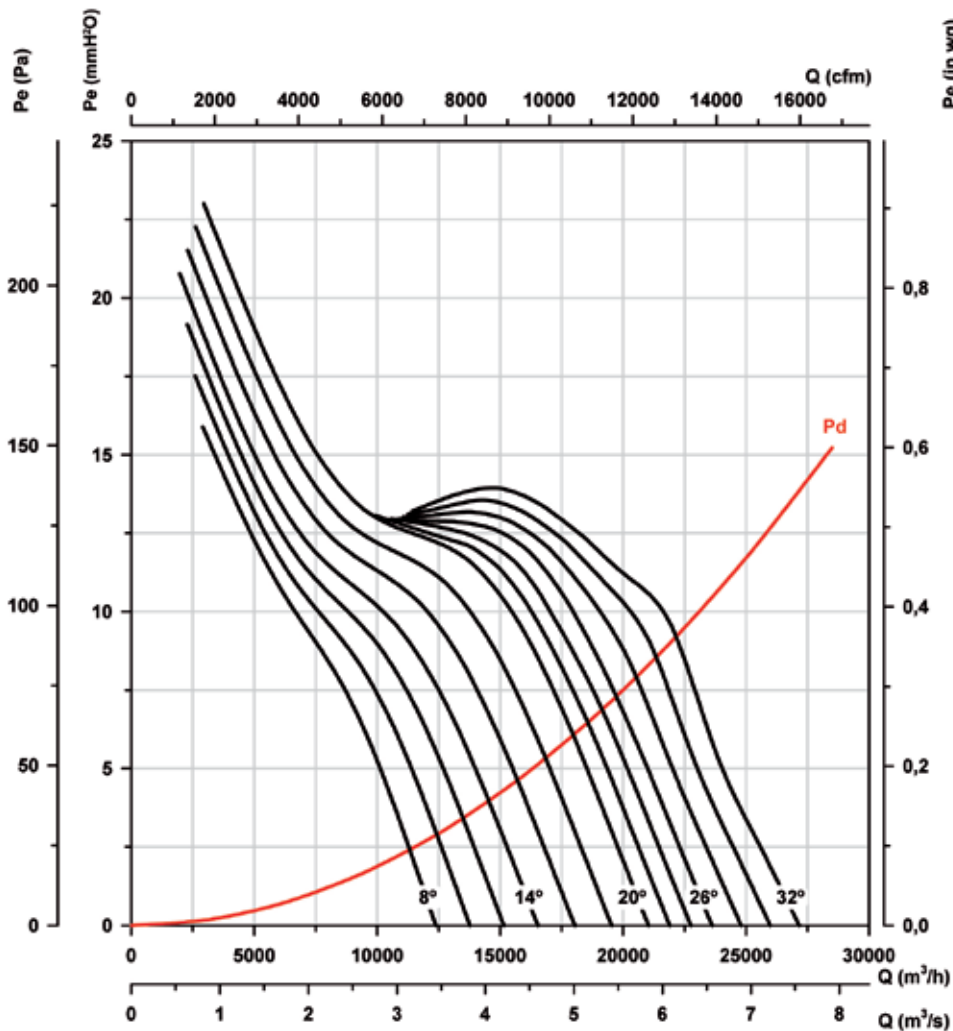

Curvas características

Q= Caudal en m³/h, m³/s y cfm.

Pe= Presión estática en mmH₂O, Pa e inwg.

Diámetro Hélice (cm): 90

Número de polos: 4

Número de palas: 6

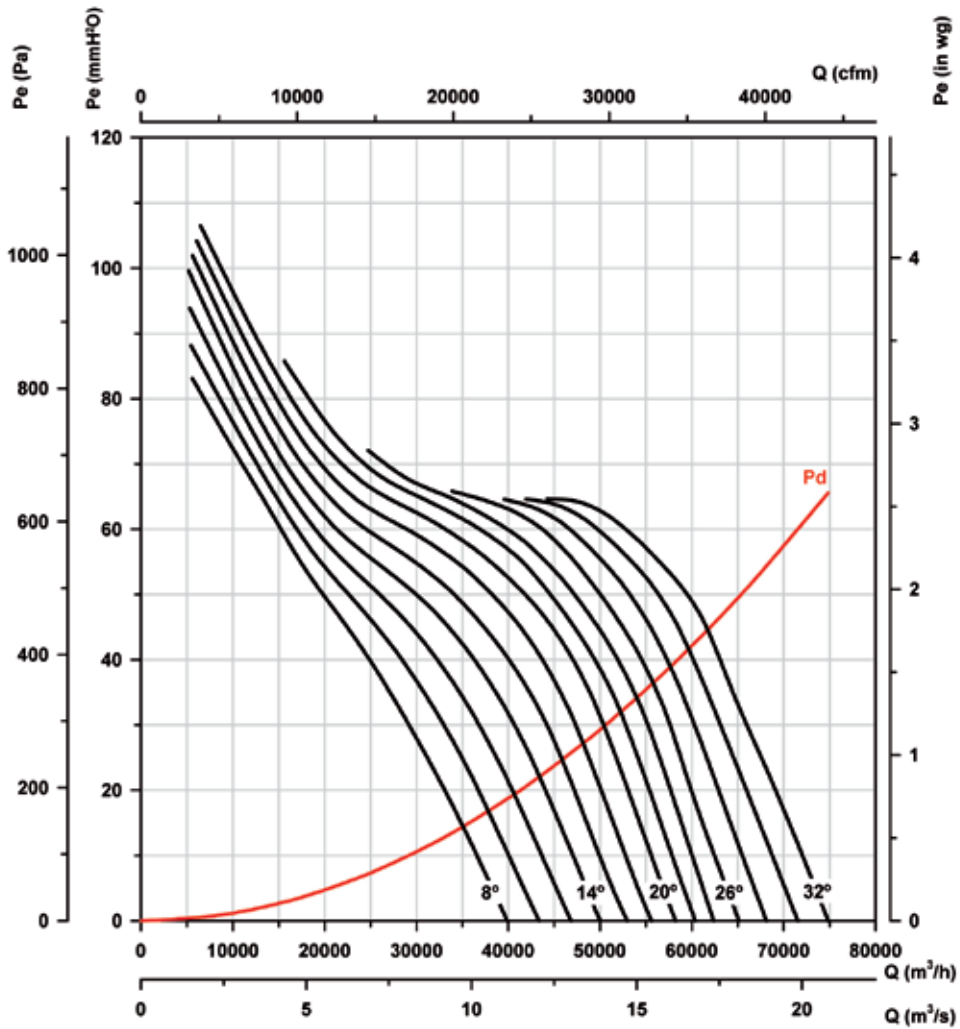

Potencia absorbida

Potencia Motor Recomendada kw(CV)

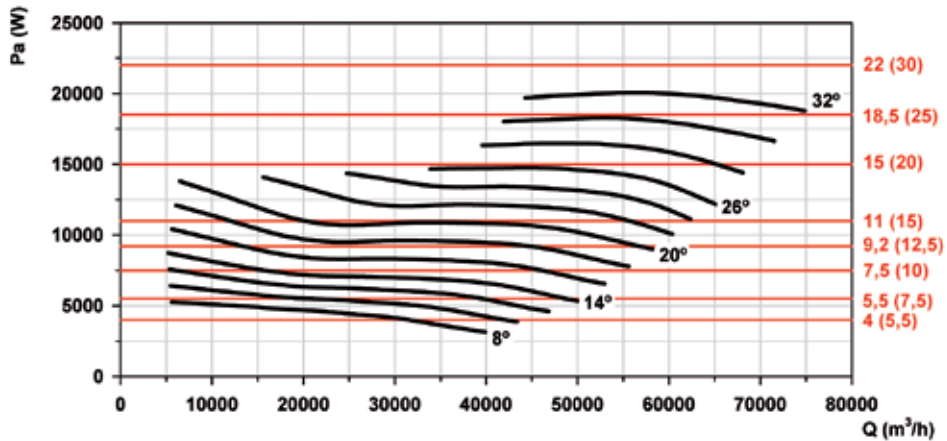

Curvas características

Q= Caudal en m³/h, m³/s y cfm.

Pe= Presión estática en mmH₂O, Pa e inwg.

Diámetro Hélice (cm): 90

Número de polos: 6

Número de palas: 6

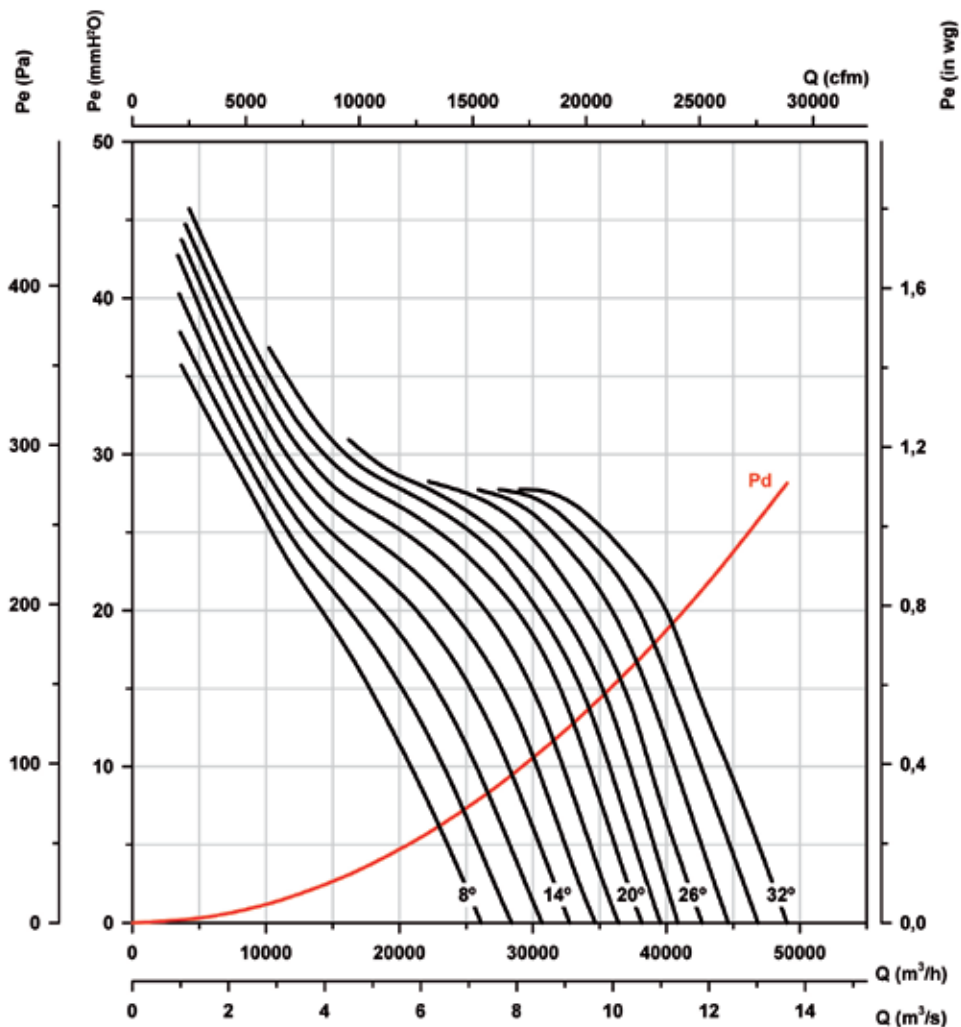

Potencia absorbida

Potencia Motor Recomendada kw(CV)

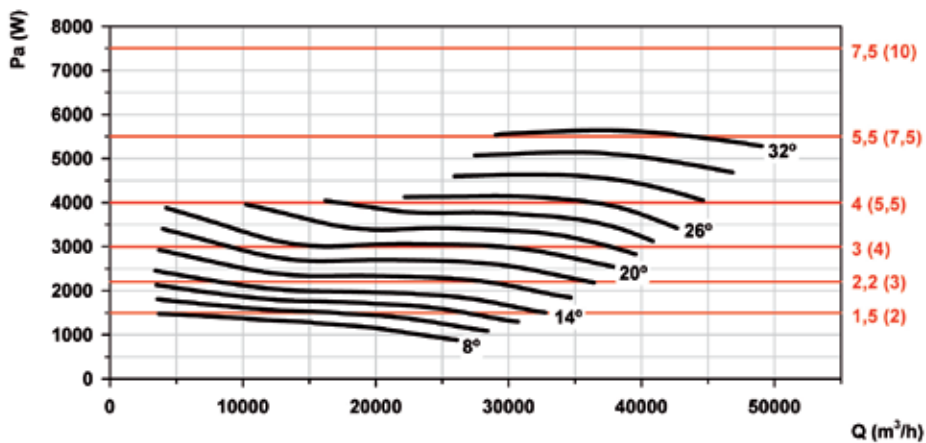

Curvas características

Q= Caudal en m³/h, m³/s y cfm.

Pe= Presión estática en mmH²O, Pa e inwg.

Diámetro Hélice (cm): 90

Número de polos: 8

Número de palas: 6

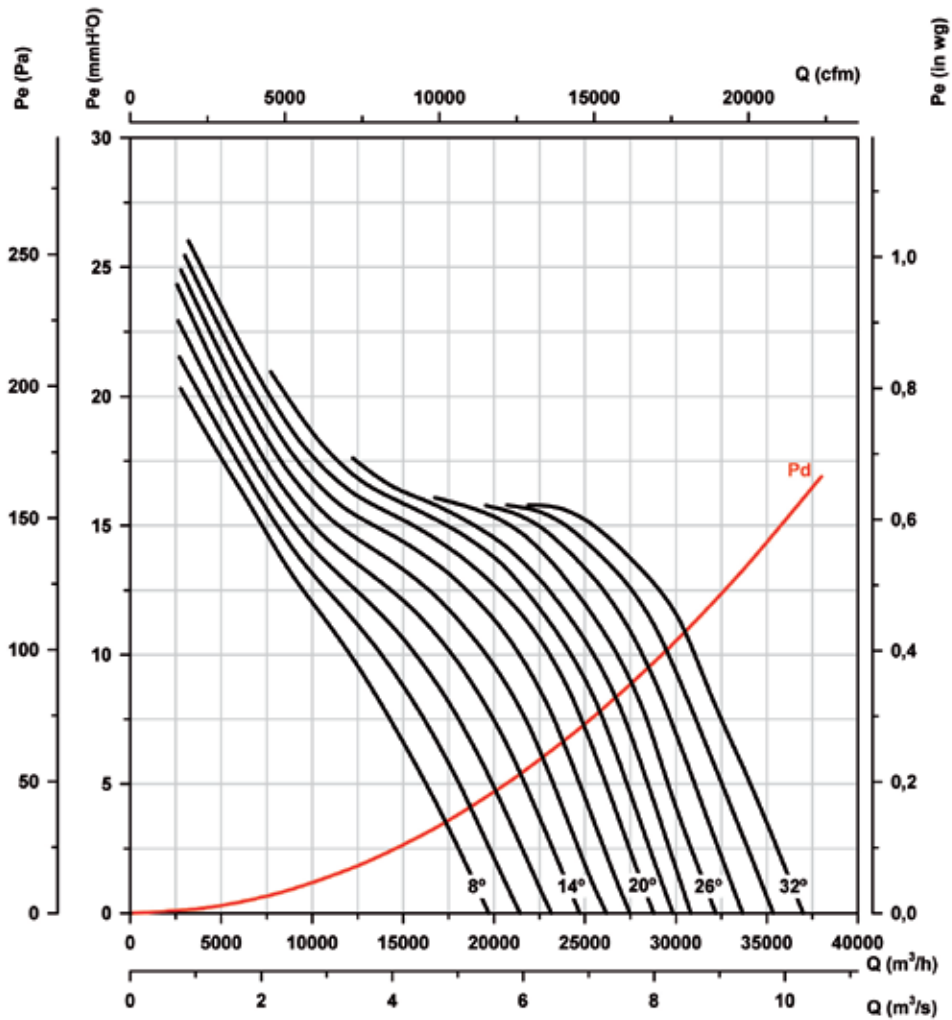

Potencia absorbida

Potencia Motor Recomendada kw(CV)

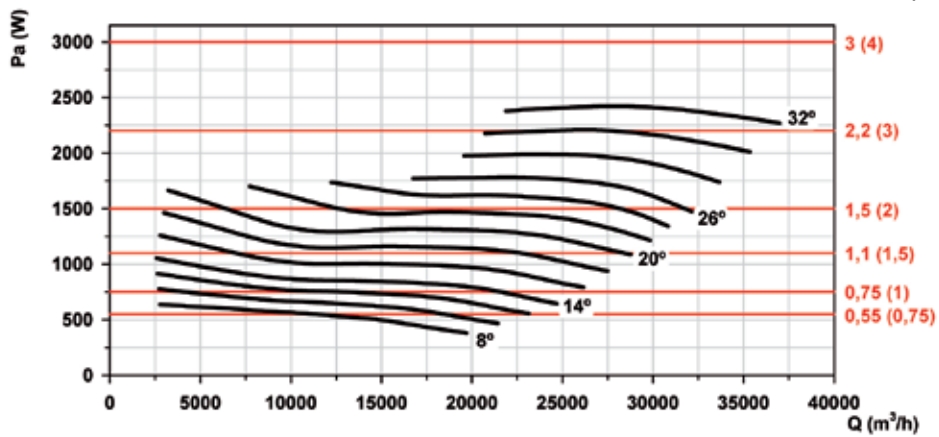

Curvas características

Q= Caudal en m³/h, m³/s y cfm. Pe= Presión estática en mmH₂O, Pa e inwg.

Diámetro Hélice (cm): 100

Número de polos: 4

Número de palas: 6

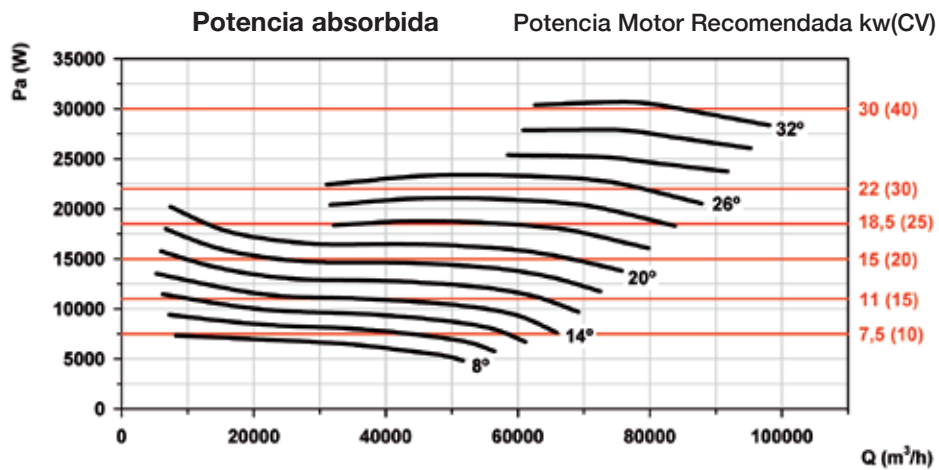
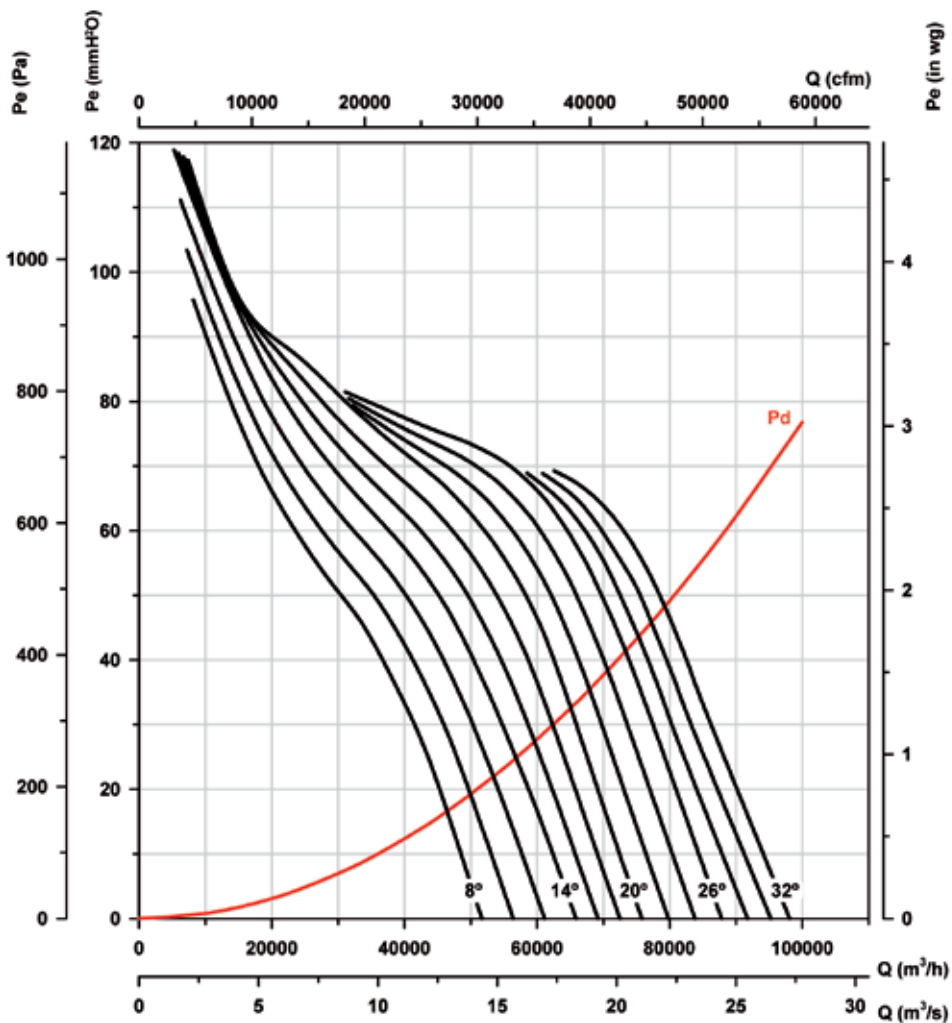

Curvas características

Q= Caudal en m³/h, m³/s y cfm. Pe= Presión estática en mmH₂O, Pa e inwg.

Diámetro Hélice (cm): 100 Número de polos: 6

Número de palas: 6

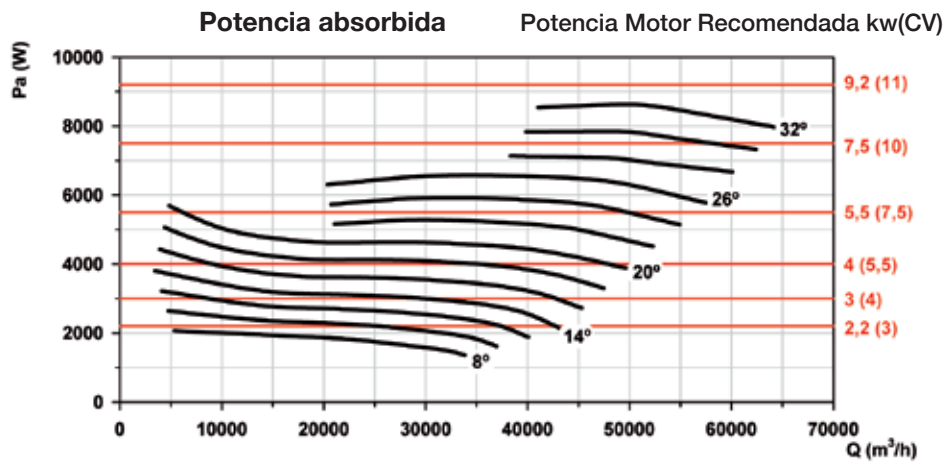
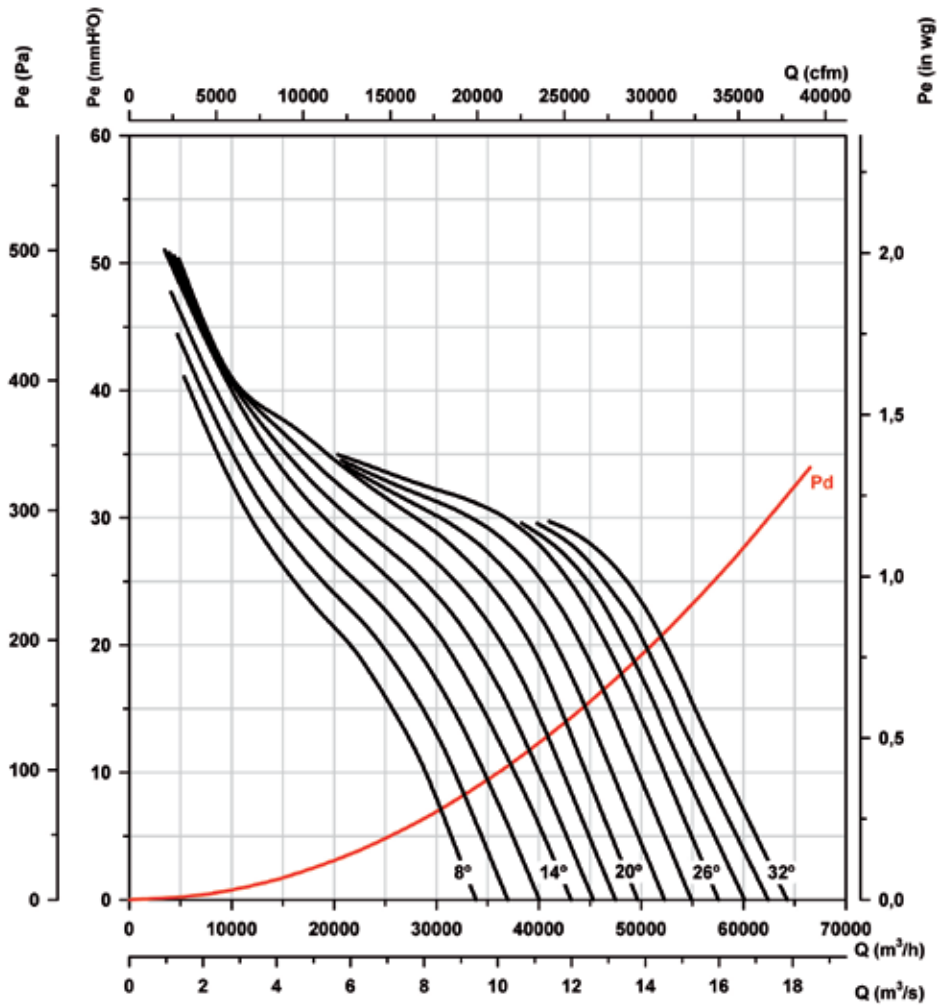

Curvas características

Q= Caudal en m³/h, m³/s y cfm.

Pe= Presión estática en mmH²O, Pa e inwg.

Diámetro Hélice (cm): 100

Número de polos: 8

Número de palas: 6

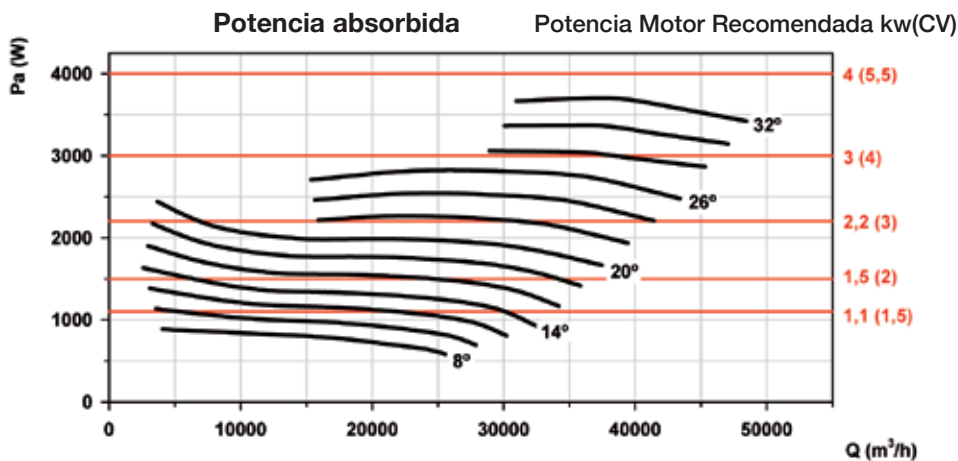
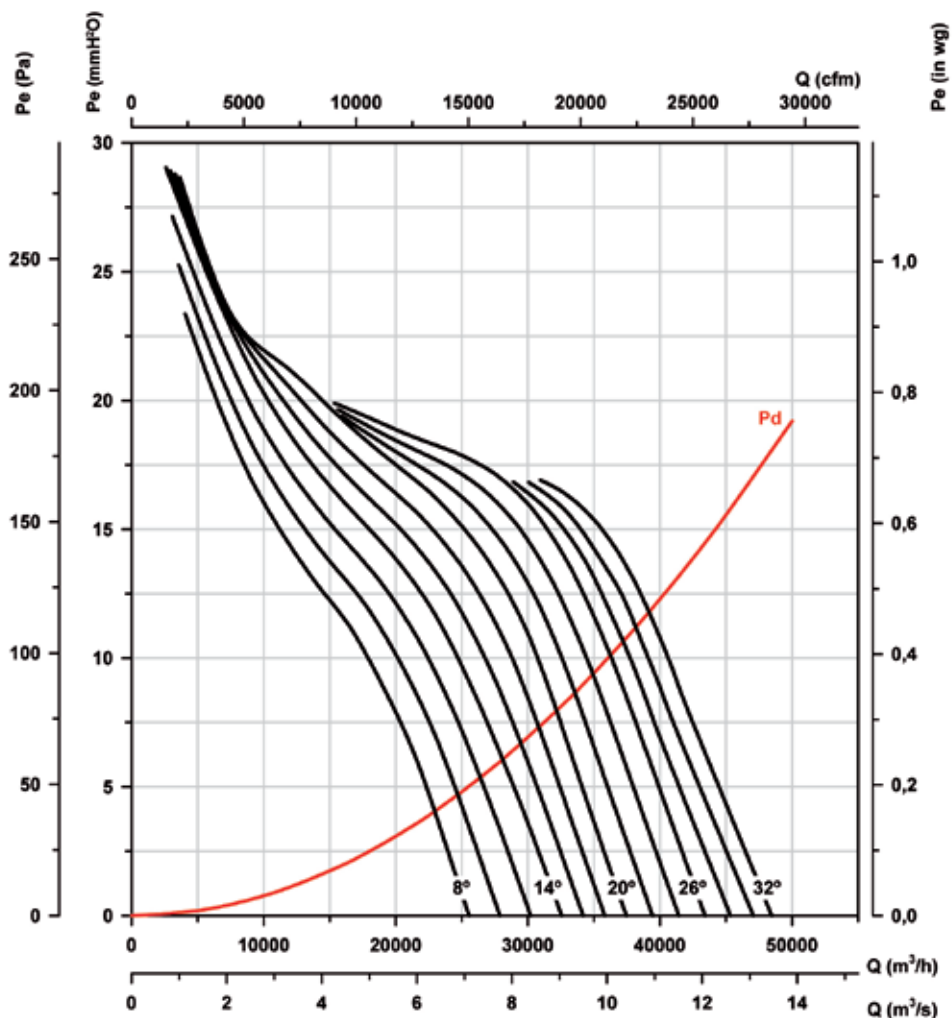

Curvas características

Q= Caudal en m³/h, m³/s y cfm.

Pe= Presión estática en mmH₂O, Pa e inwg.

Diámetro Hélice (cm): 125

Número de polos: 4

Número de palas: 3

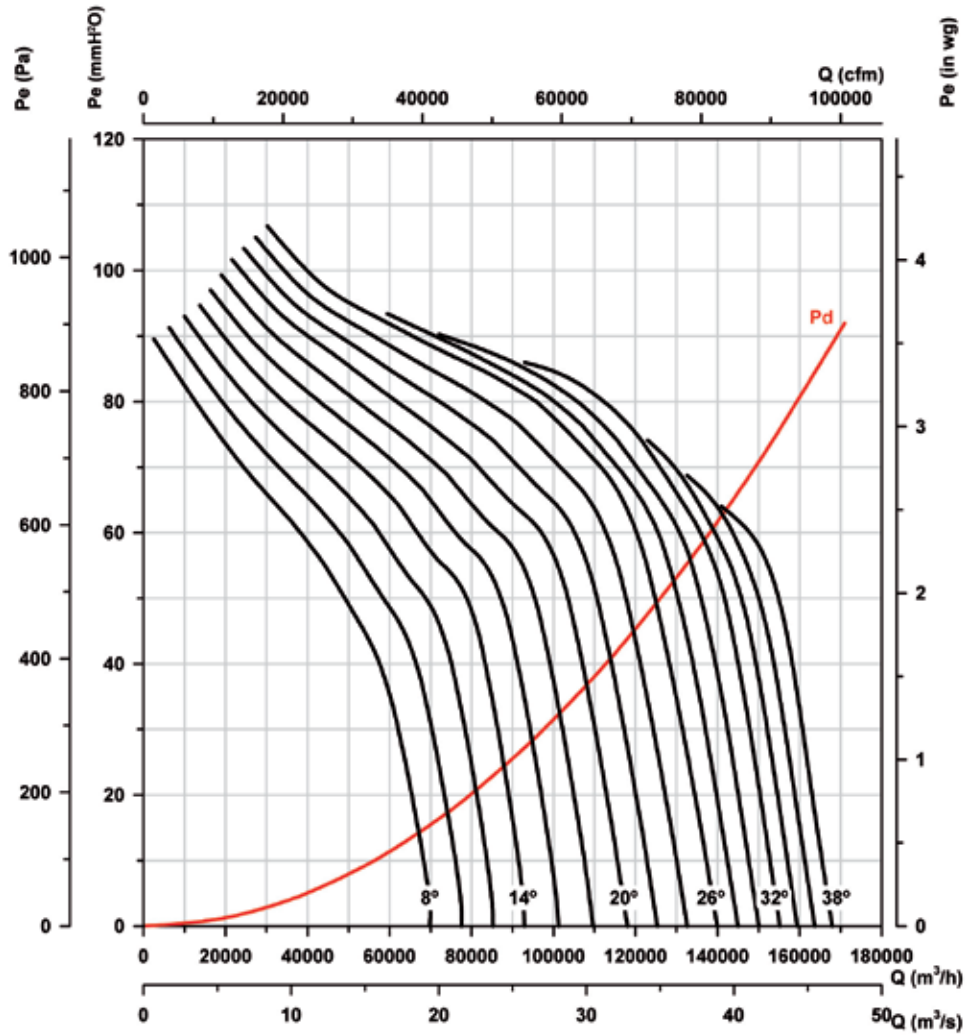

Potencia absorbida

Potencia Motor Recomendada kw(CV)

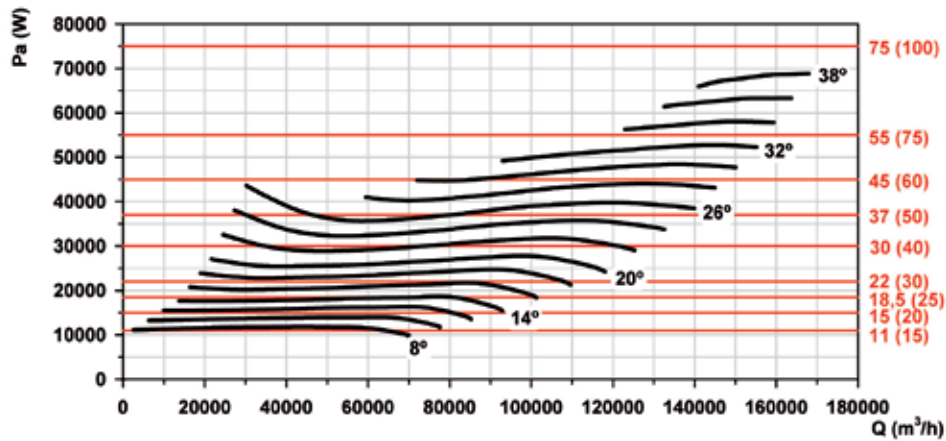

Curvas características

Q= Caudal en m³/h, m³/s y cfm.

Pe= Presión estática en mmH₂O, Pa e inwg.

Diámetro Hélice (cm): 125

Número de polos: 4

Número de palas: 6

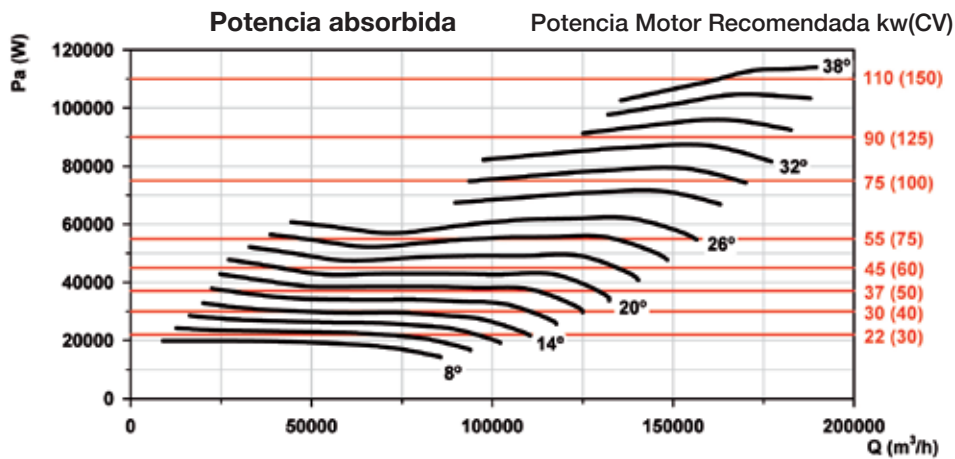
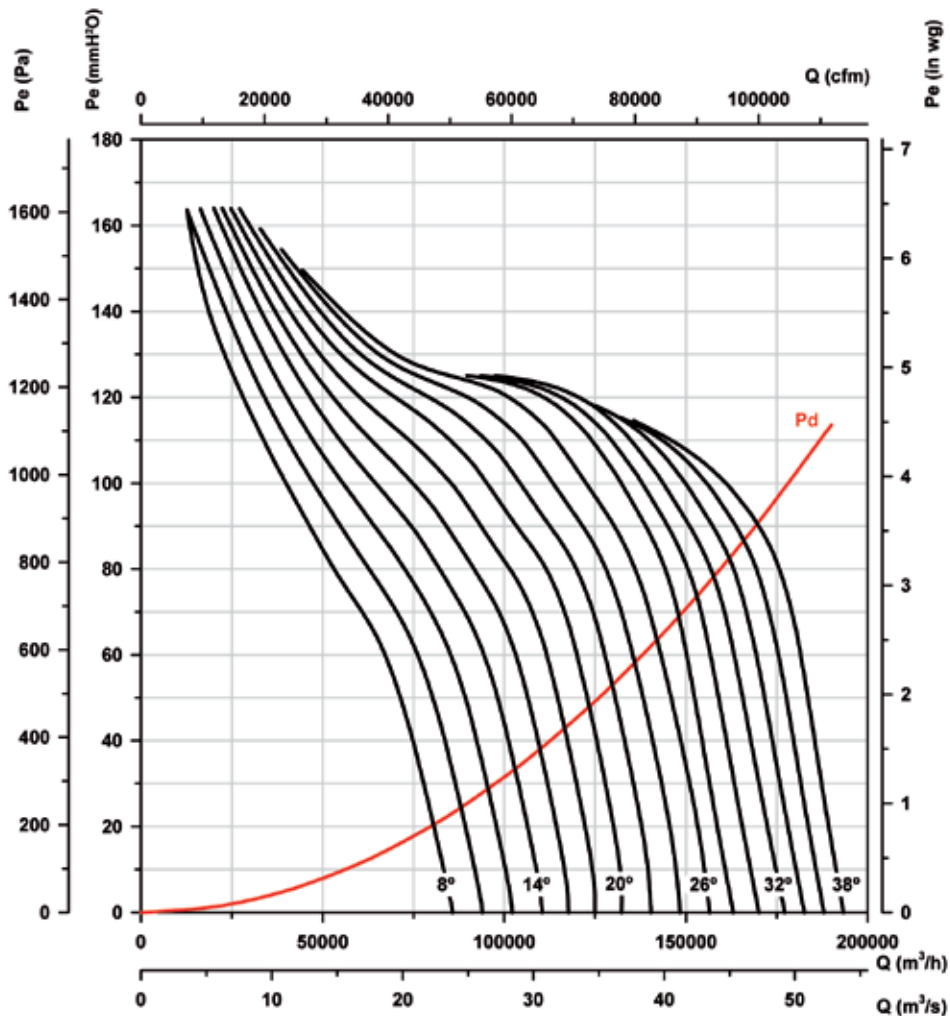

Curvas características

Q= Caudal en m³/h, m³/s y cfm.

Pe= Presión estática en mmH²O, Pa e inwg.

Diámetro Hélice (cm): 125

Número de polos: 4

Número de palas: 9

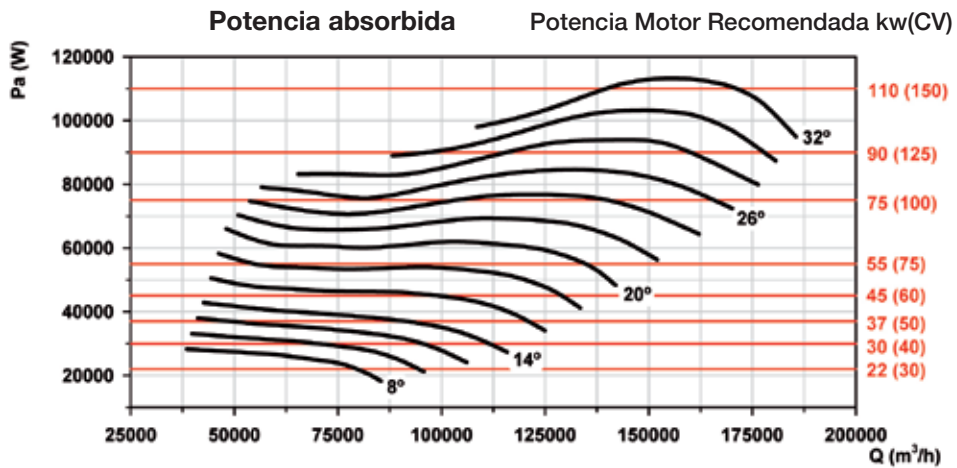
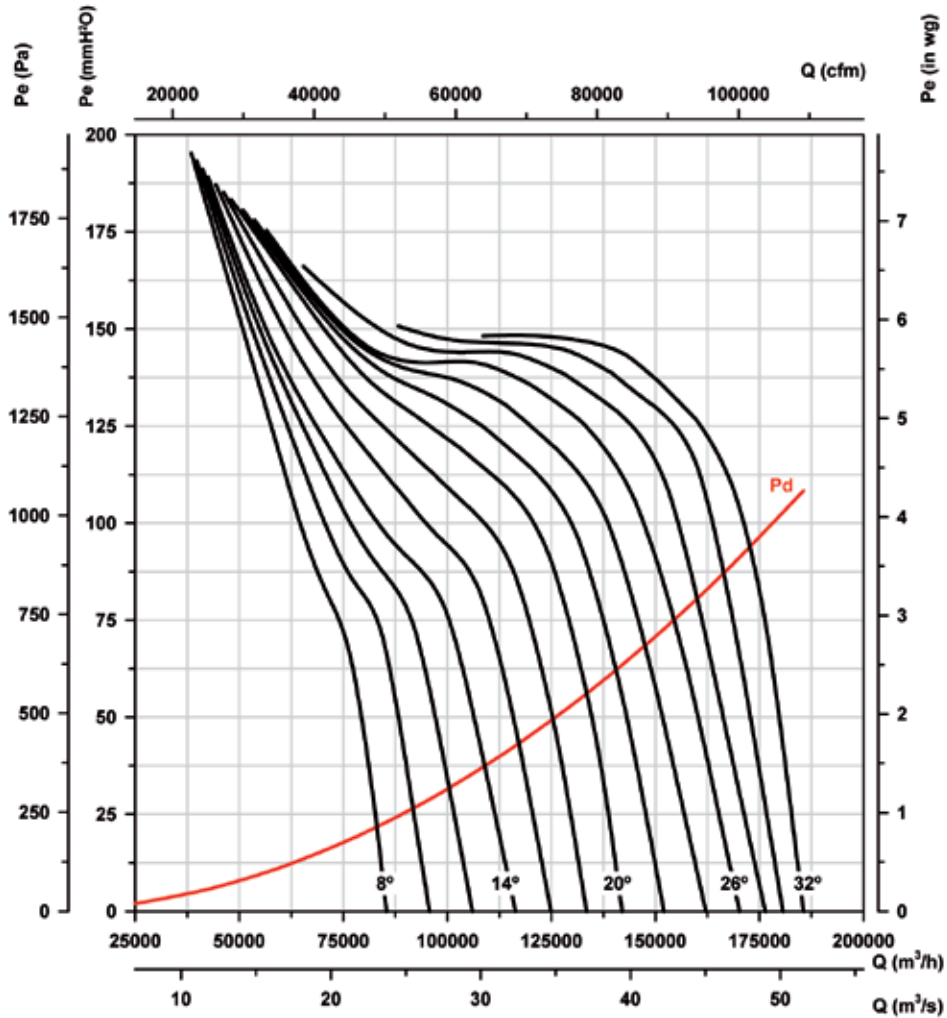

Curvas características

Q= Caudal en m³/h, m³/s y cfm.

Pe= Presión estática en mmH²O, Pa e inwg.

Diámetro Hélice (cm): 125

Número de polos: 6

Número de palas: 3

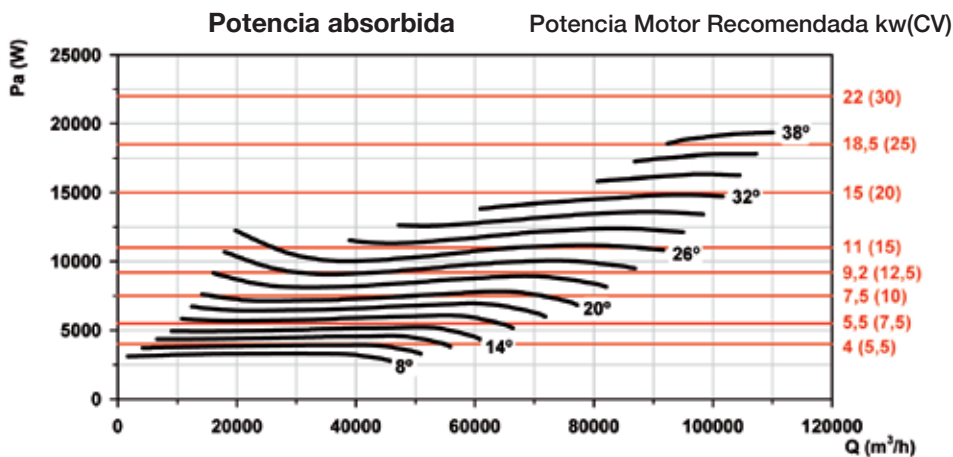
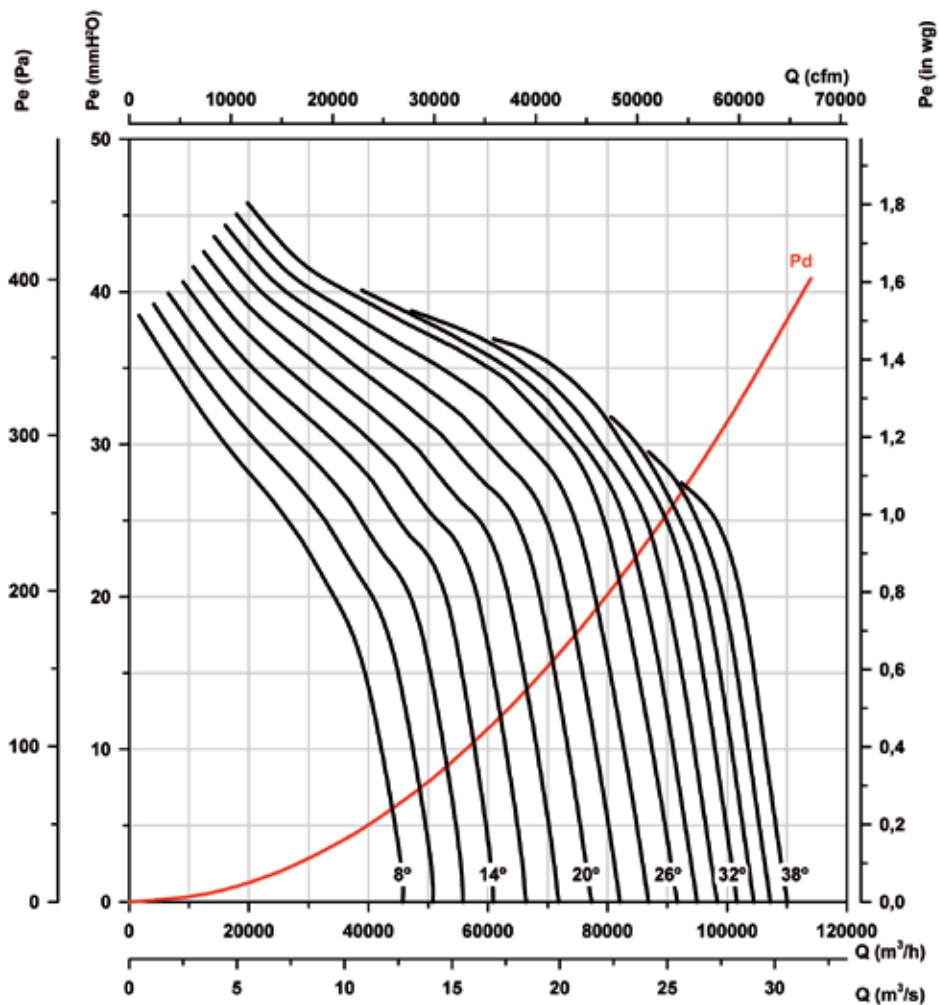

Curvas características

Q= Caudal en m³/h, m³/s y cfm.

Pe= Presión estática en mmH₂O, Pa e inwg.

Diámetro Hélice (cm): 125

Número de polos: 6

Número de palas: 6

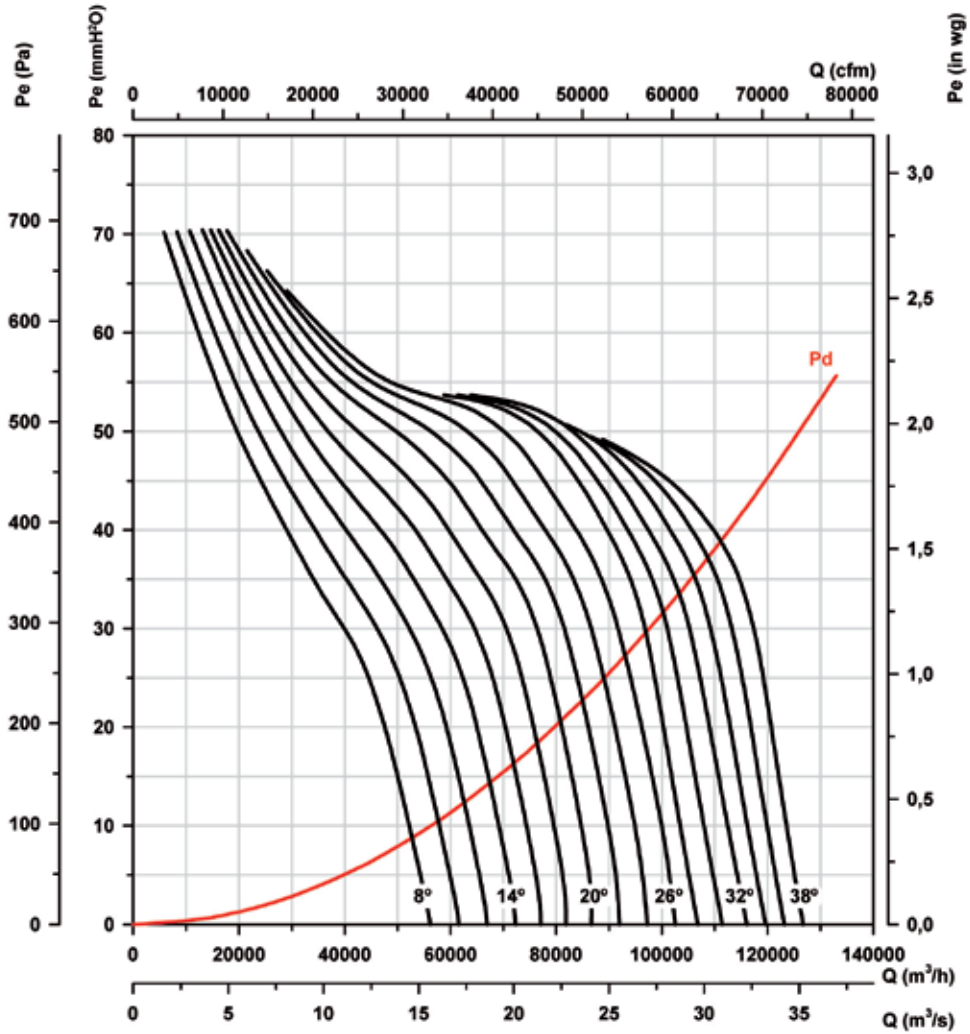

Potencia absorbida

Potencia Motor Recomendada kw(CV)

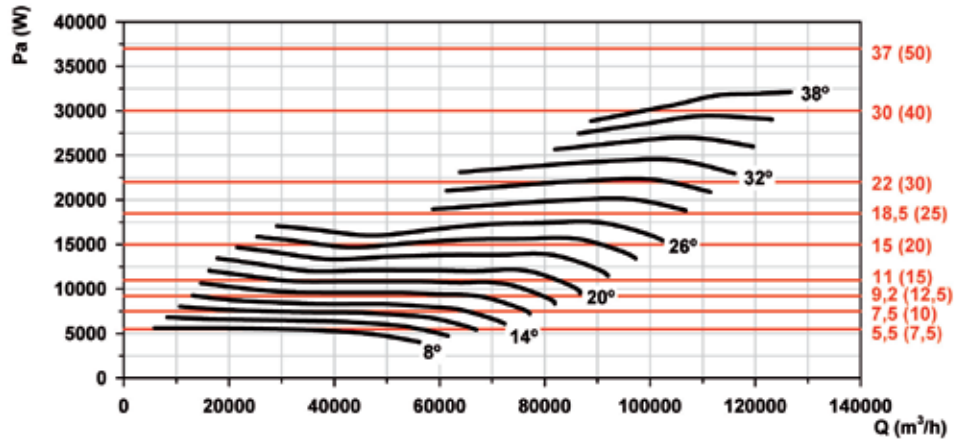

Curvas características

Q= Caudal en m³/h, m³/s y cfm.

Pe= Presión estática en mmH₂O, Pa e inwg.

Diámetro Hélice (cm): 125

Número de polos: 6

Número de palas: 9

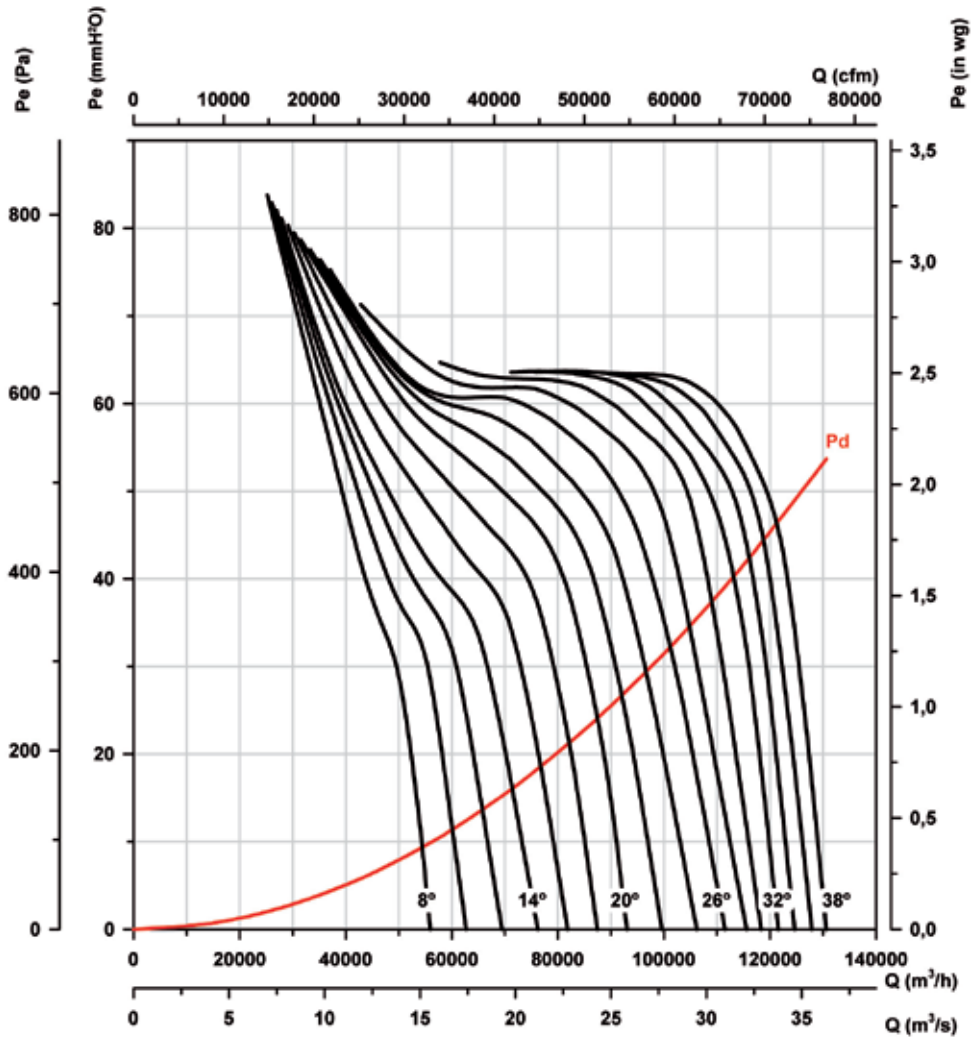

Potencia absorbida

Potencia Motor Recomendada kw(CV)

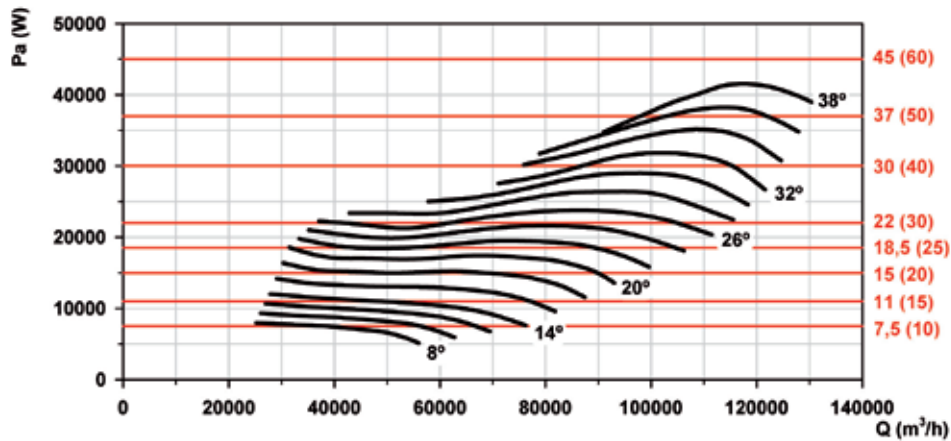

Curvas características

Q= Caudal en m³/h, m³/s y cfm.

Pe= Presión estática en mmH₂O, Pa e inwg.

Diámetro Hélice (cm): 140

Número de polos: 6

Número de palas: 3

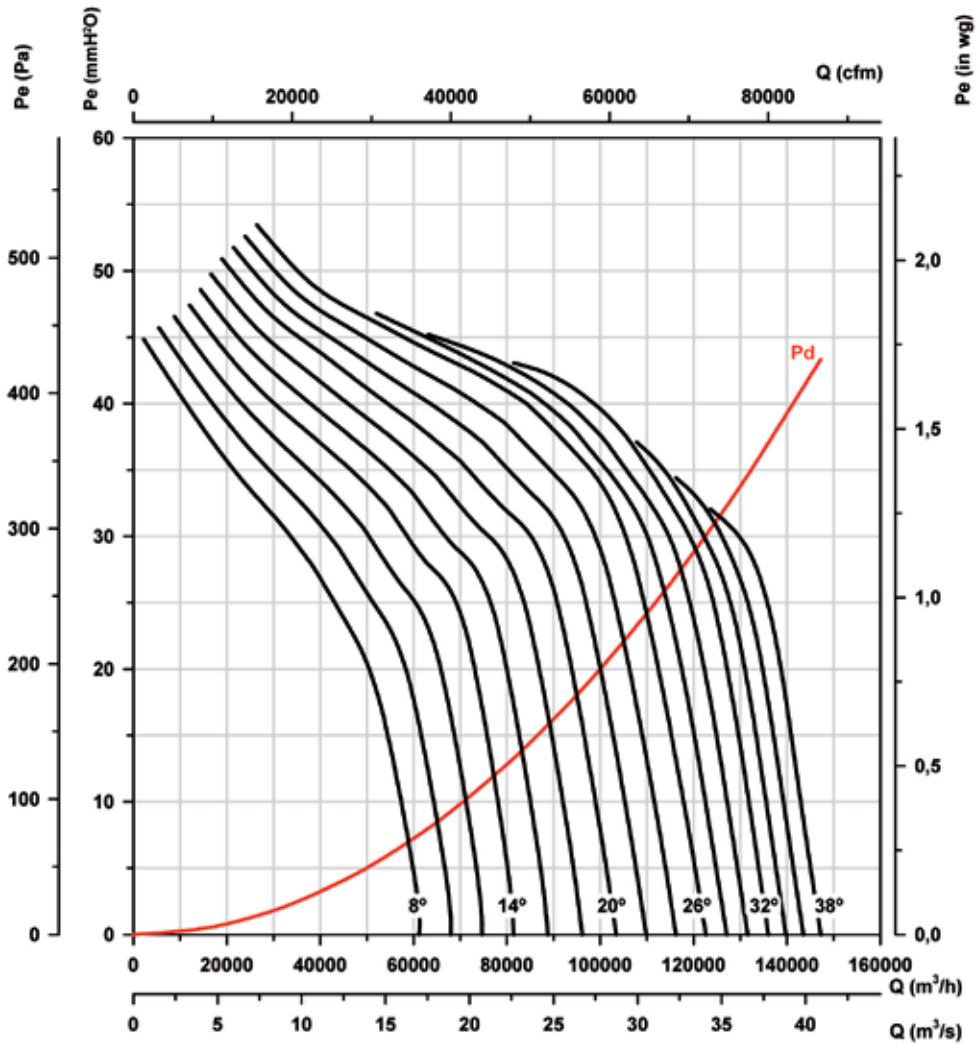

Potencia absorbida

Potencia Motor Recomendada kw(CV)

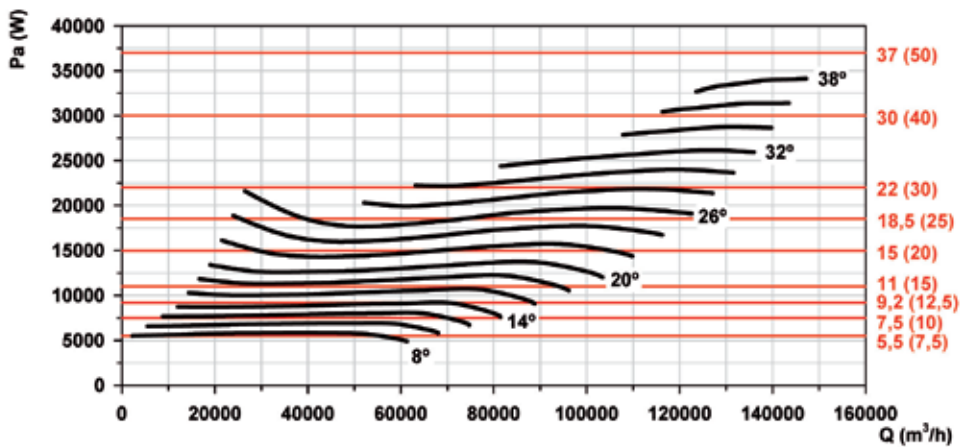

Curvas características

Q= Caudal en m³/h, m³/s y cfm.

Pe= Presión estática en mmH₂O, Pa e inwg.

Diámetro Hélice (cm): 140

Número de polos: 6

Número de palas: 6

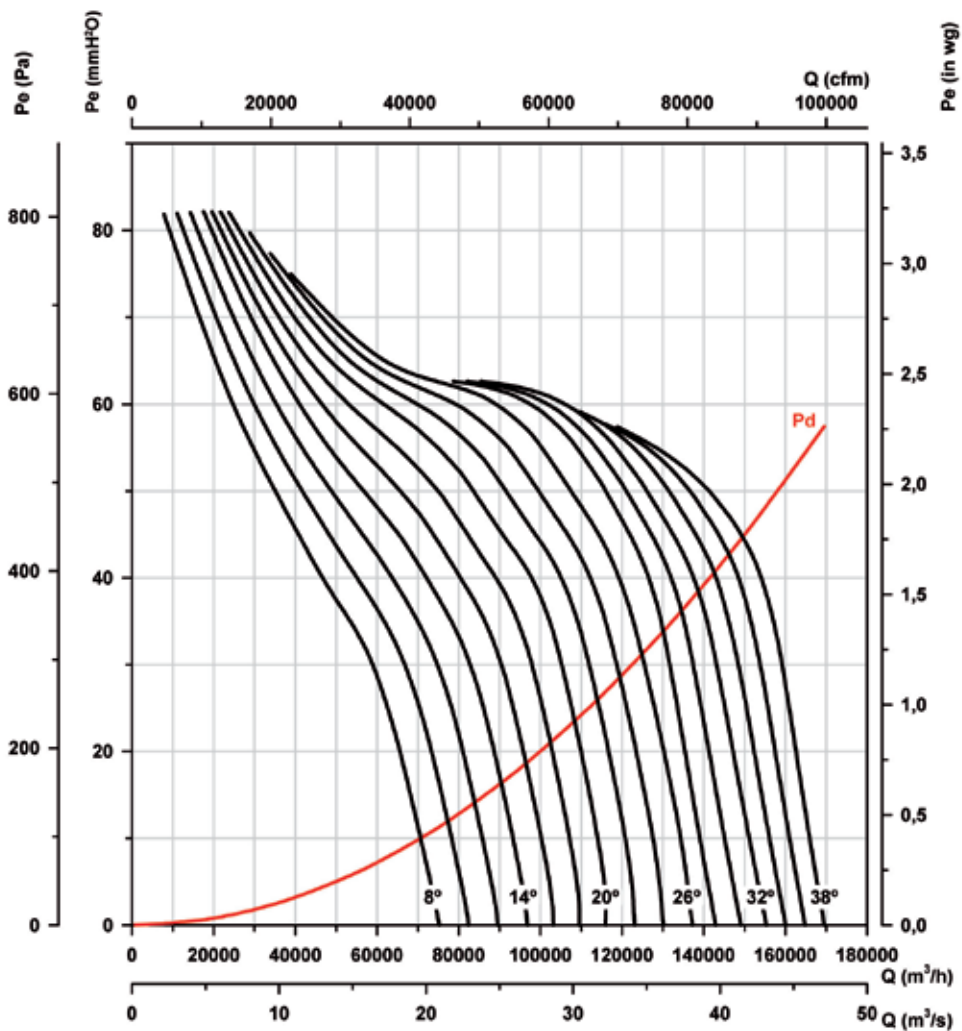

Potencia absorbida

Potencia Motor Recomendada kw(CV)

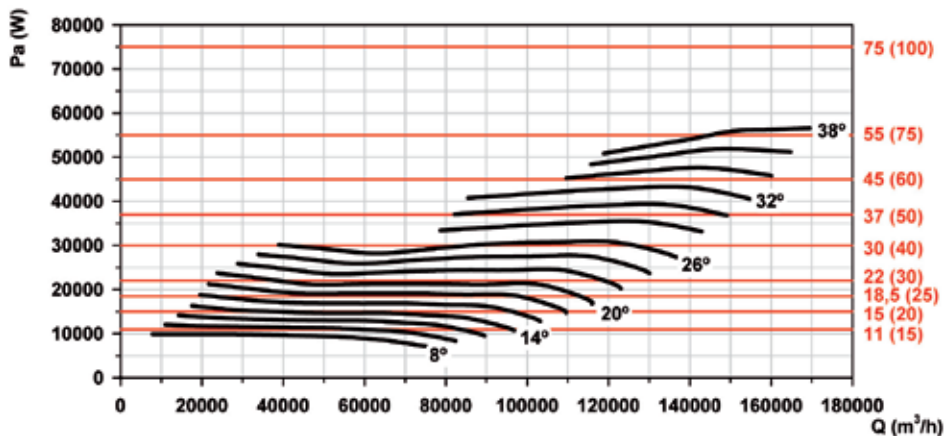

Curvas características

Q= Caudal en m³/h, m³/s y cfm.

Pe= Presión estática en mmH₂O, Pa e inwg.

Diámetro Hélice (cm): 140

Número de polos: 6

Número de palas: 9

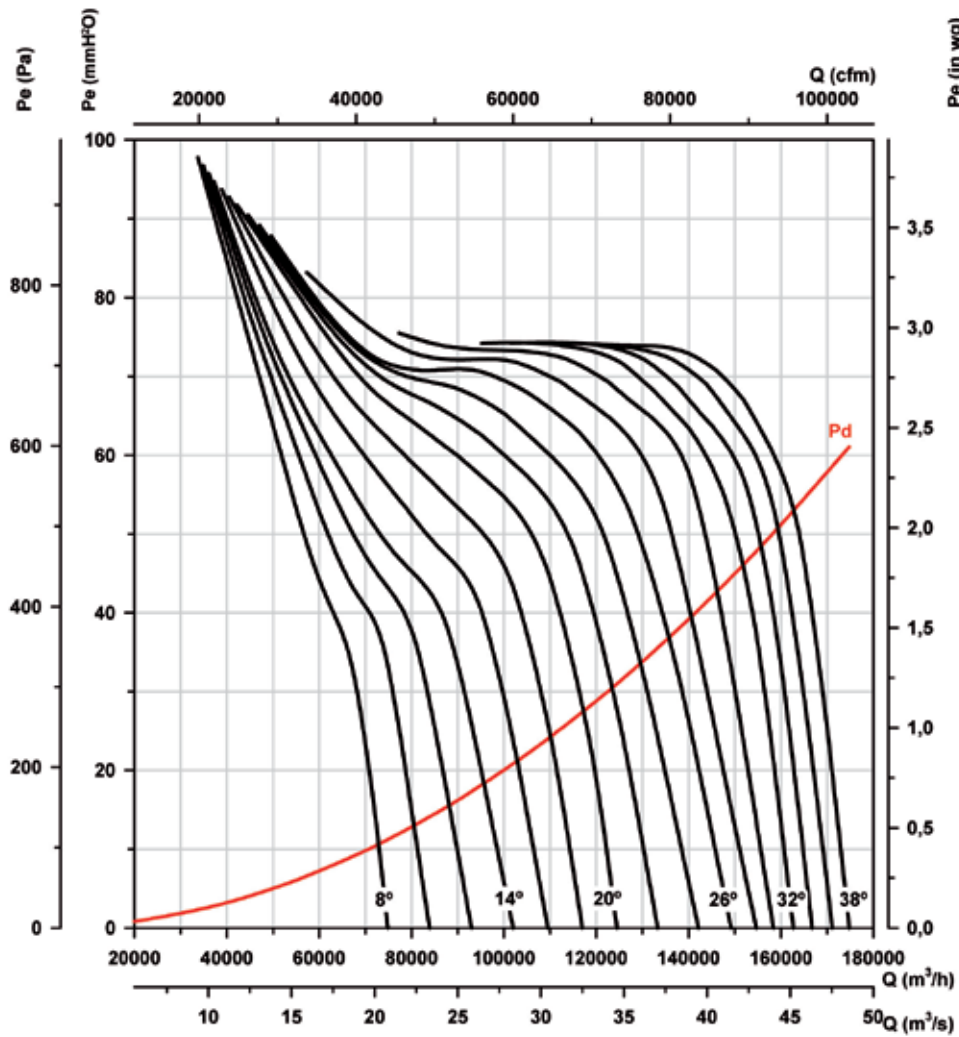

Potencia absorbida

Potencia Motor Recomendada kw(CV)

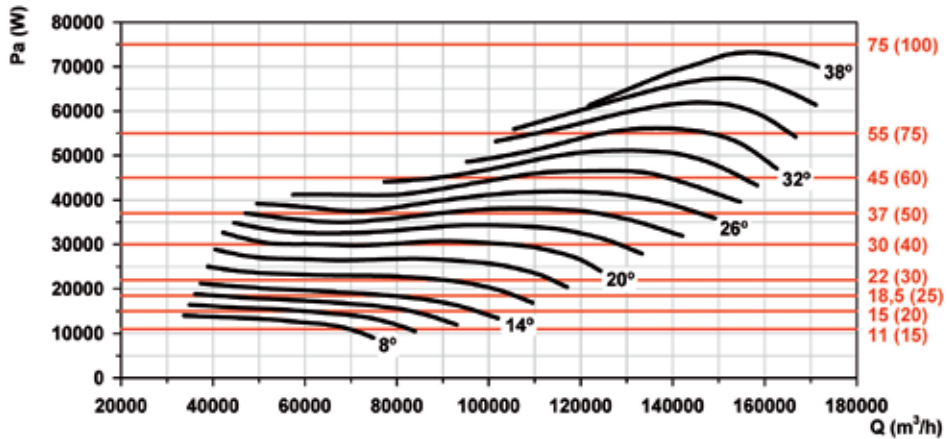

Curvas características

Q= Caudal en m³/h, m³/s y cfm.

Pe= Presión estática en mmH₂O, Pa e inwg.

Diámetro Hélice (cm): 140

Número de polos: 8

Número de palas: 3

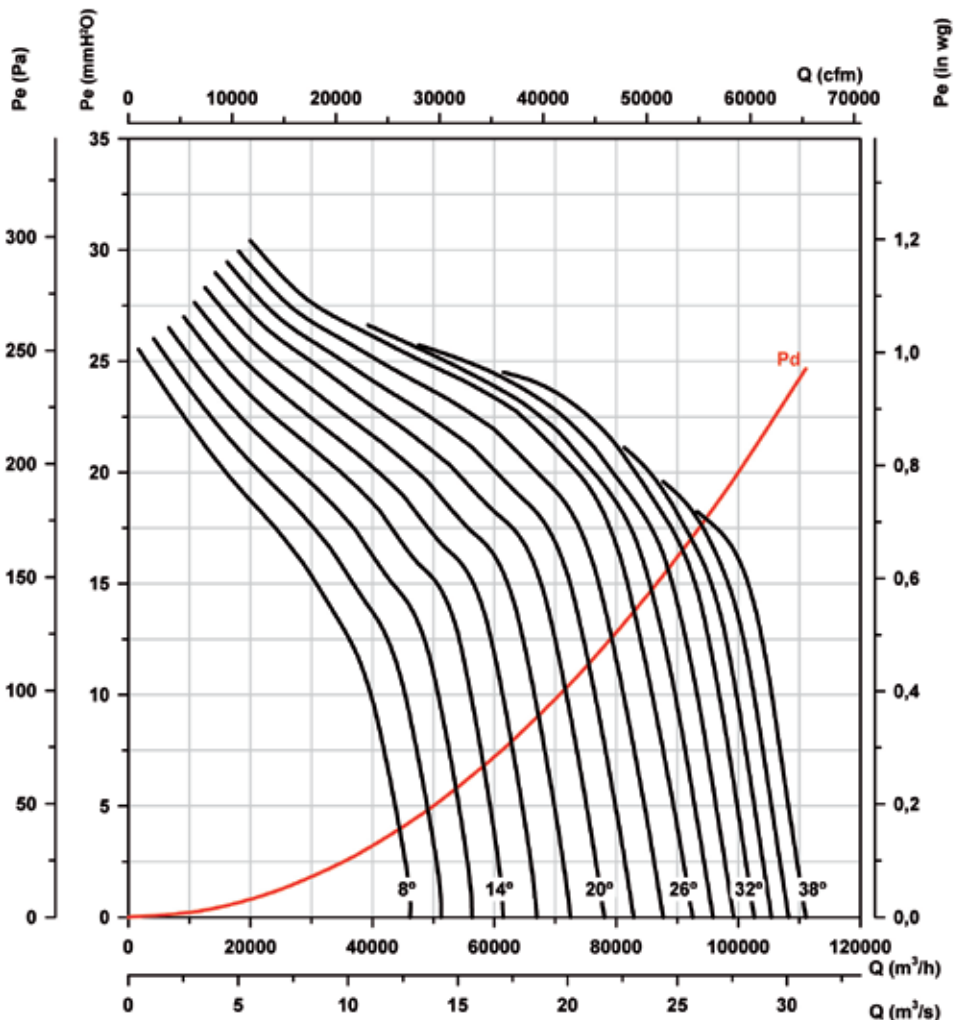

Potencia absorbida

Potencia Motor Recomendada kw(CV)

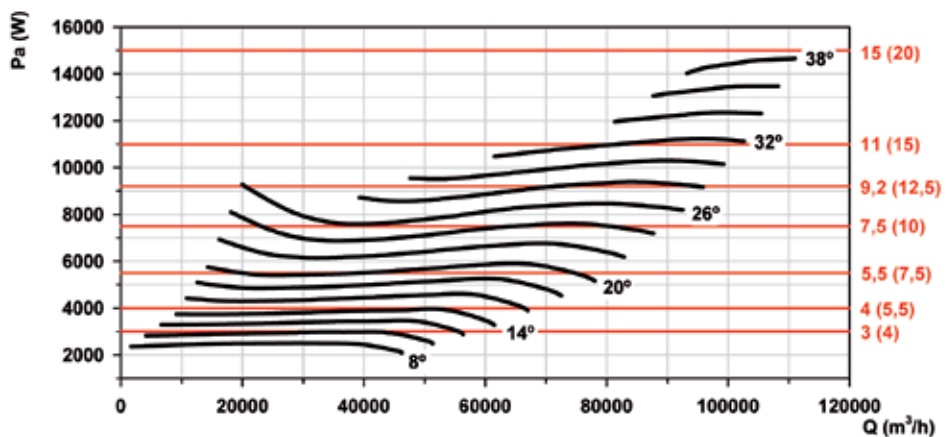

Curvas características

Q= Caudal en m³/h, m³/s y cfm.

Pe= Presión estática en mmH₂O, Pa e inwg.

Diámetro Hélice (cm): 140

Número de polos: 8

Número de palas: 6

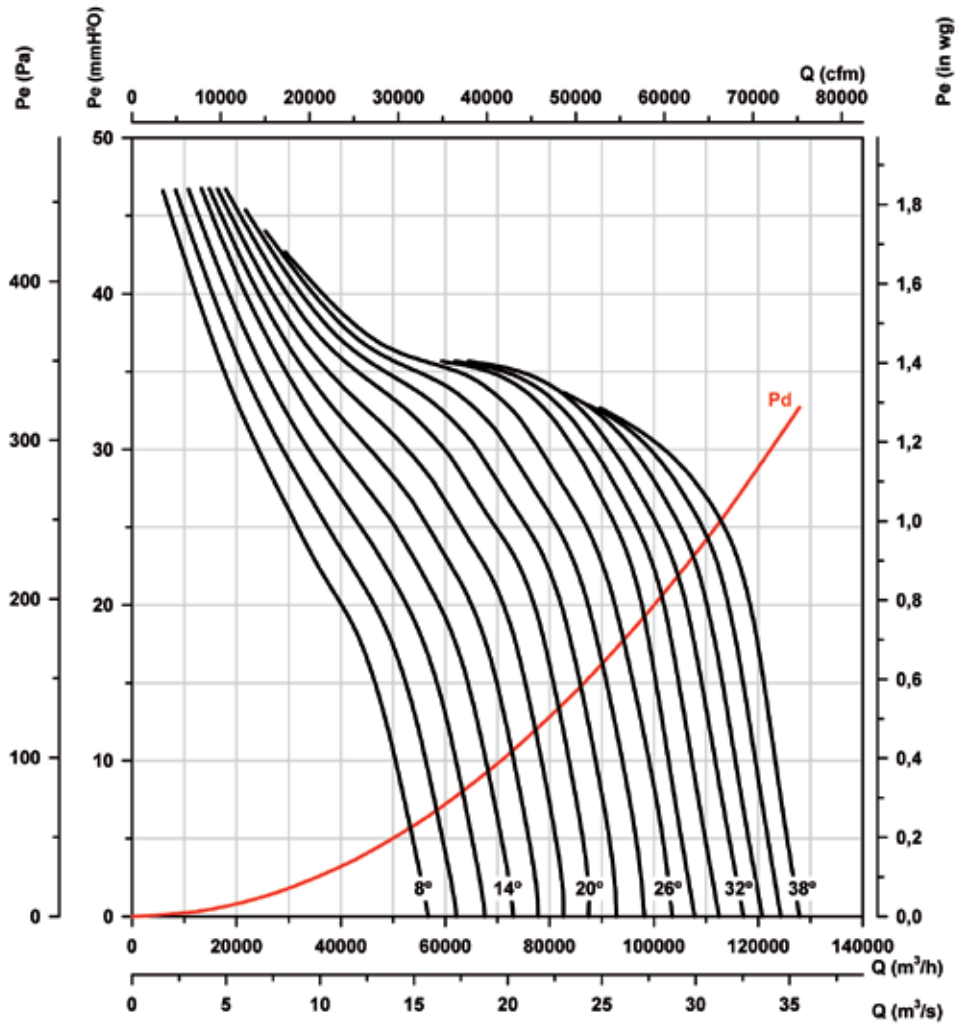

Potencia absorbida

Potencia Motor Recomendada kw(CV)

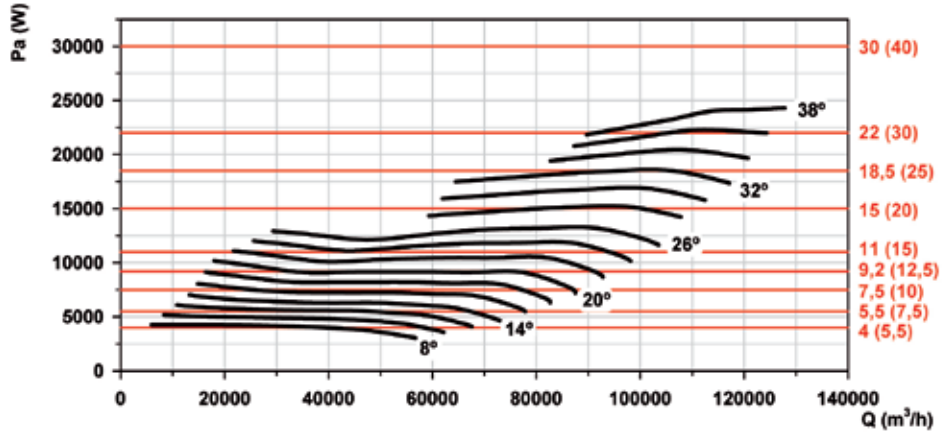

Curvas características

Q= Caudal en m³/h, m³/s y cfm.

Pe= Presión estática en mmH₂O, Pa e inwg.

Diámetro Hélice (cm): 140

Número de polos: 8

Número de palas: 9

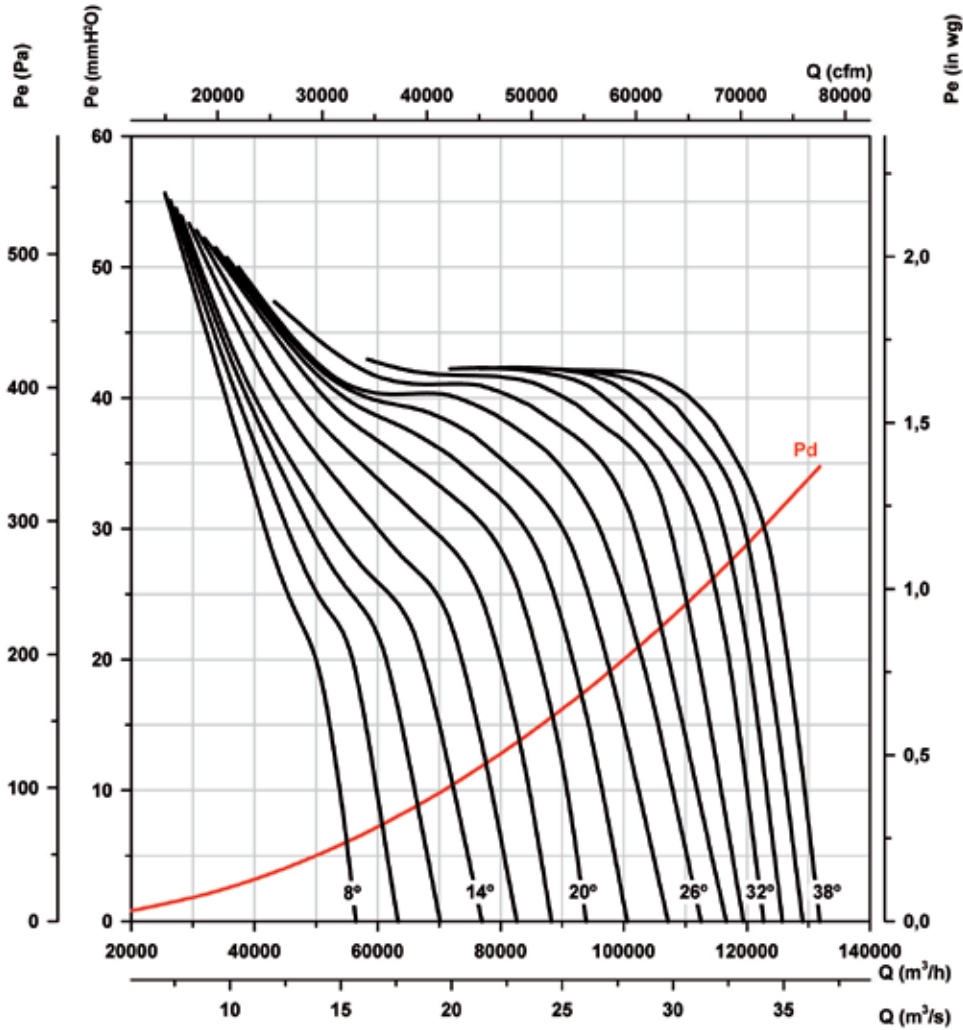

Potencia absorbida

Potencia Motor Recomendada kw(CV)

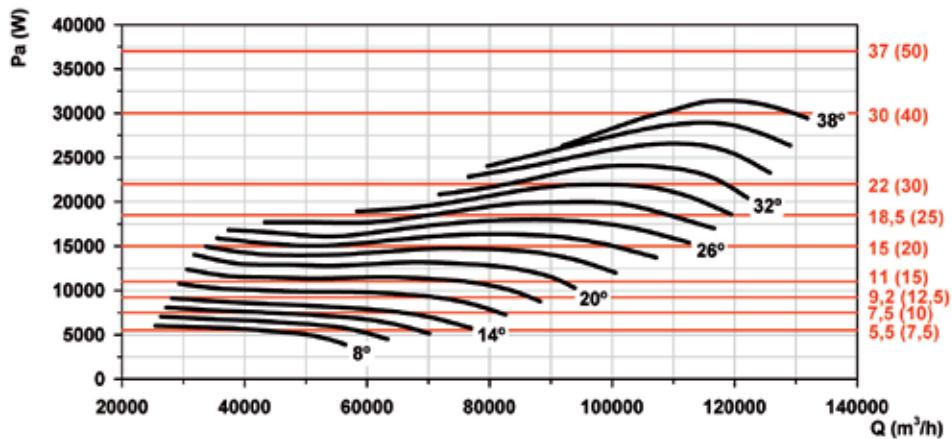

Curvas características

Q= Caudal en m³/h, m³/s y cfm.

Pe= Presión estática en mmH₂O, Pa e inwg.

Diámetro Hélice (cm): 160

Número de polos: 6

Número de palas: 3

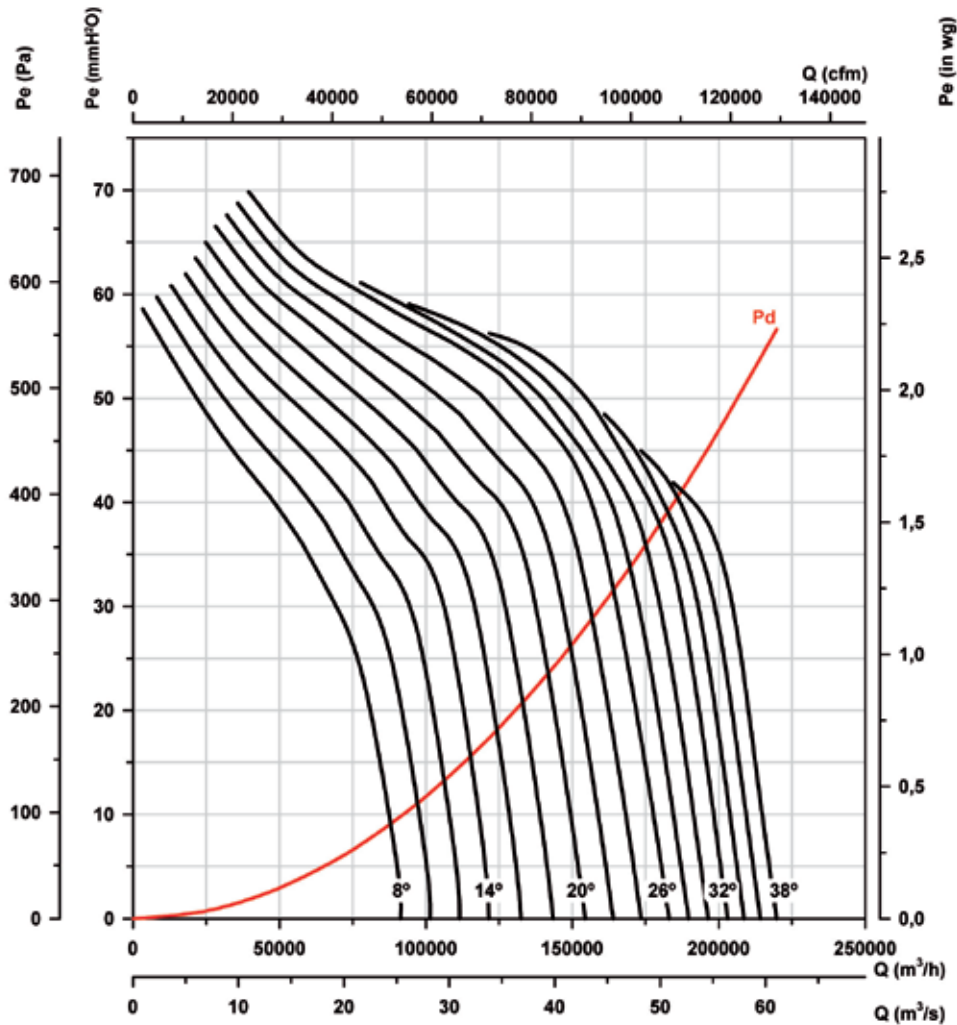

Potencia absorbida

Potencia Motor Recomendada kw(CV)

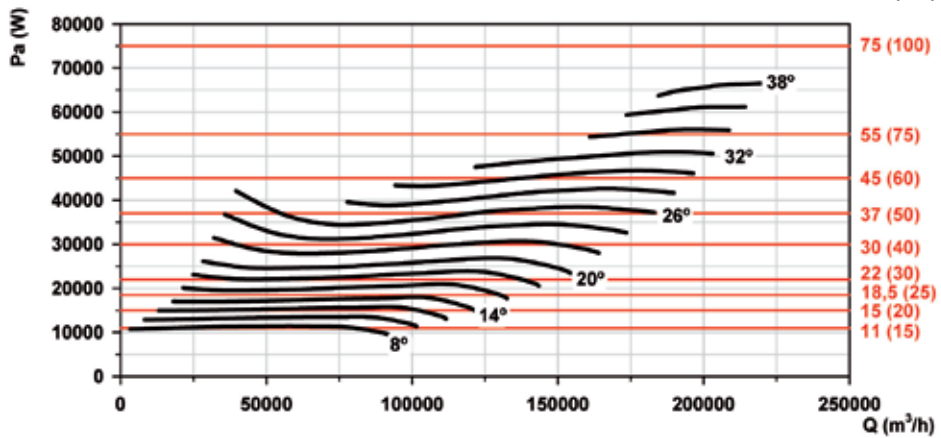

Curvas características

Q= Caudal en m³/h, m³/s y cfm.

Pe= Presión estática en mmH₂O, Pa e inwg.

Diámetro Hélice (cm): 160

Número de polos: 6

Número de palas: 8

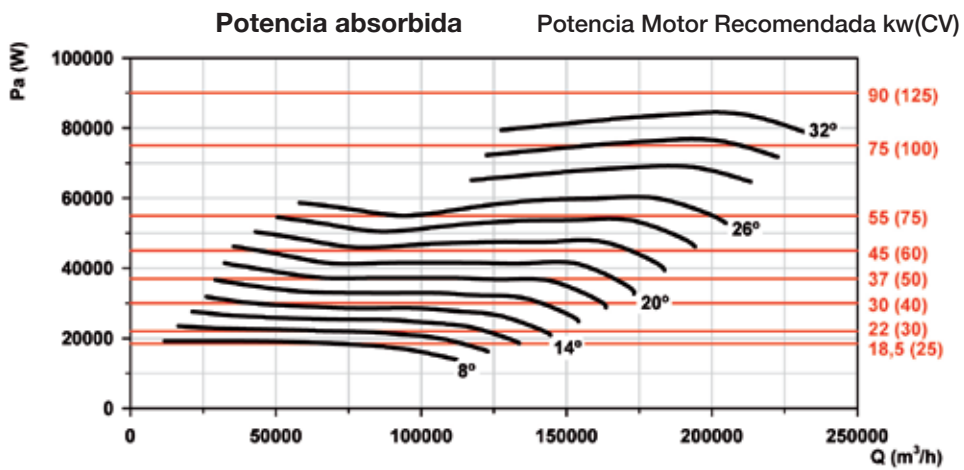
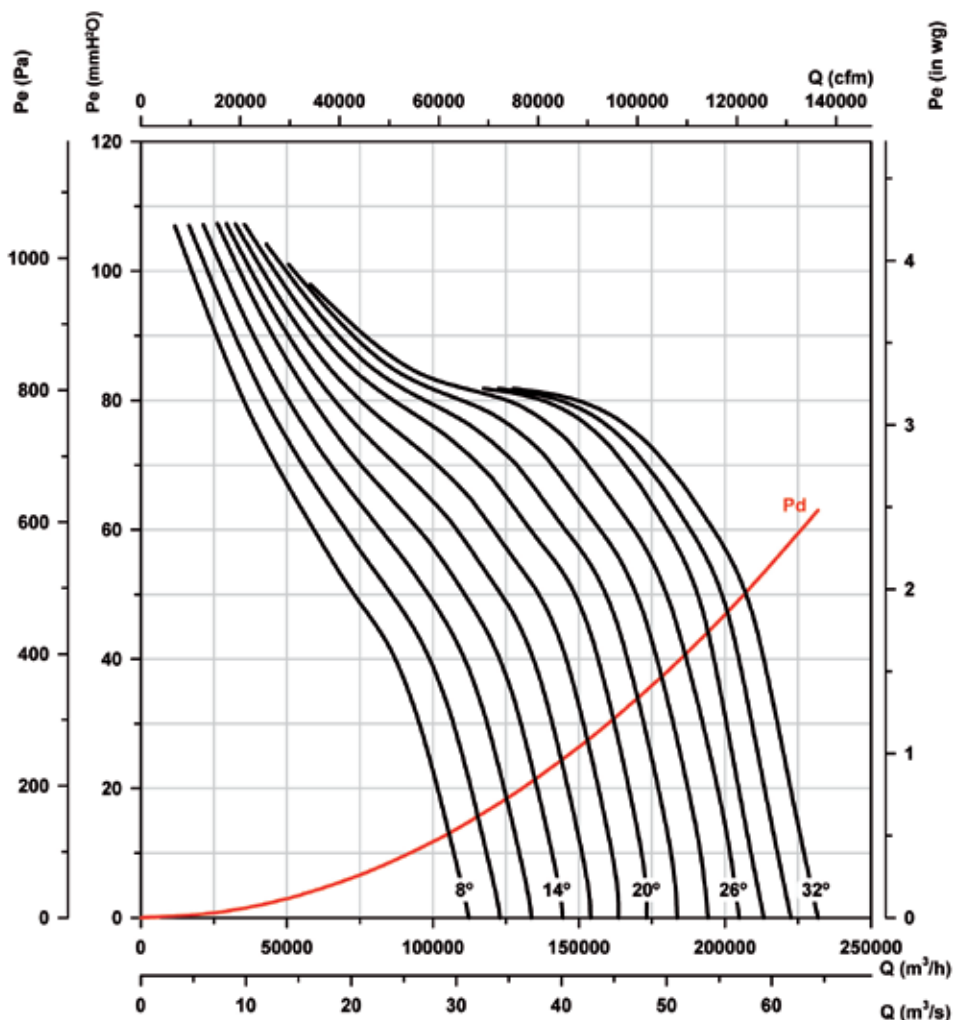

Curvas características

Q= Caudal en m³/h, m³/s y cfm.

Pe= Presión estática en mmH₂O, Pa e inwg.

Diámetro Hélice (cm): 160

Número de polos: 6

Número de palas: 9

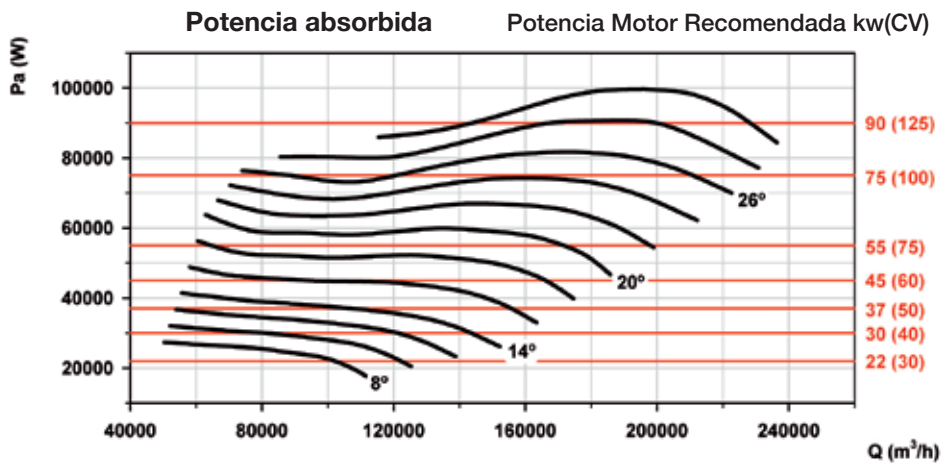
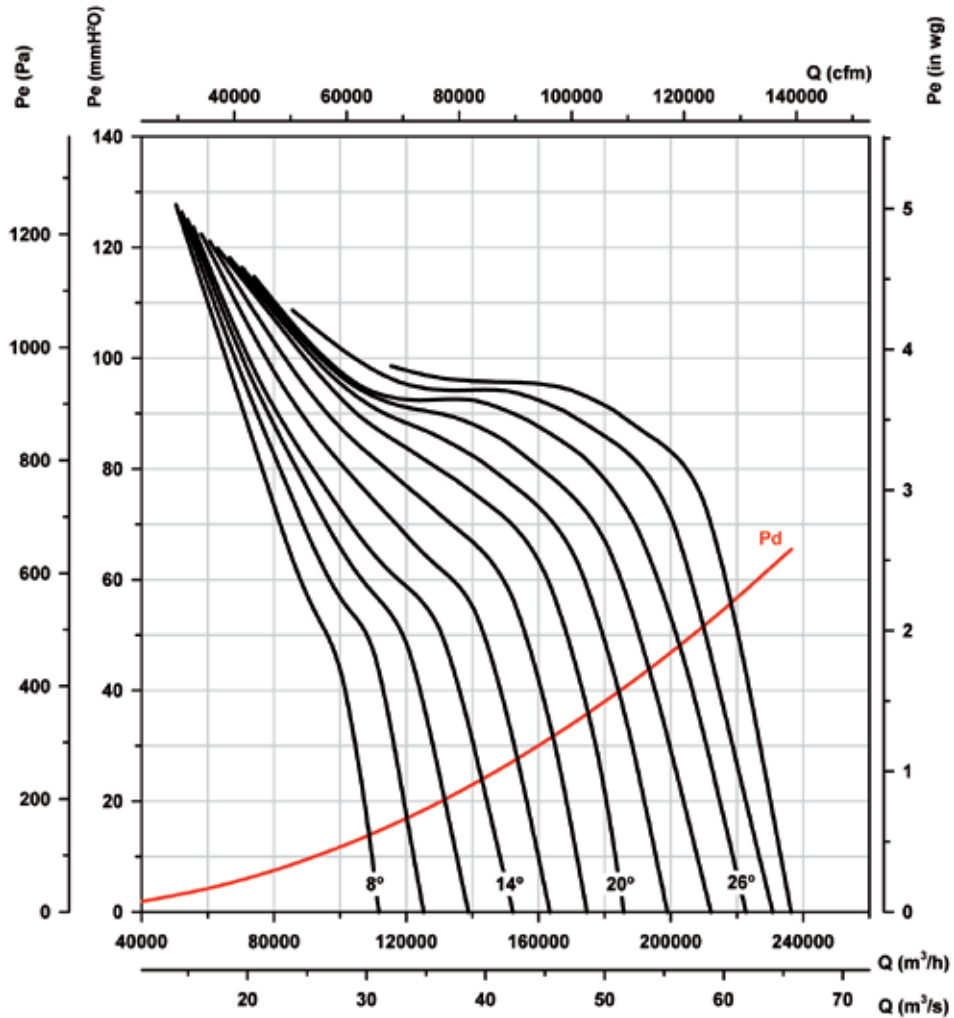

Curvas características

Q= Caudal en m³/h, m³/s y cfm.

Pe= Presión estática en mmH₂O, Pa e inwg.

Diámetro Hélice (cm): 160

Número de polos: 8

Número de palas: 3

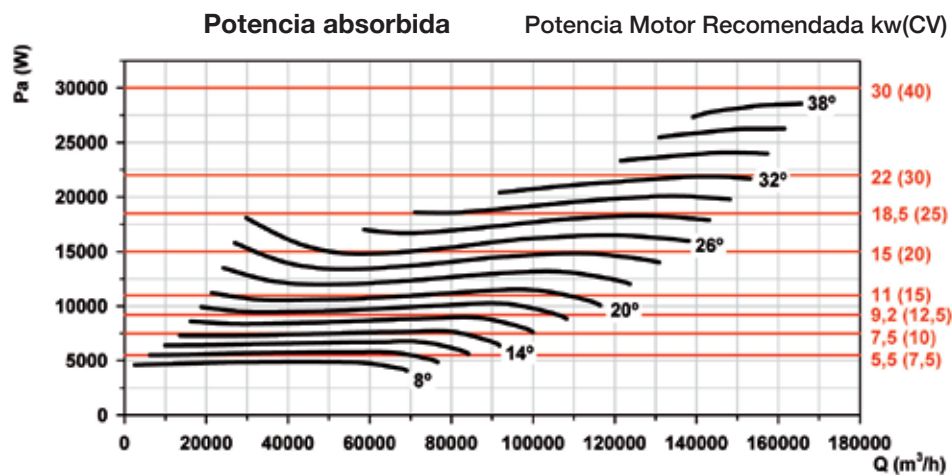
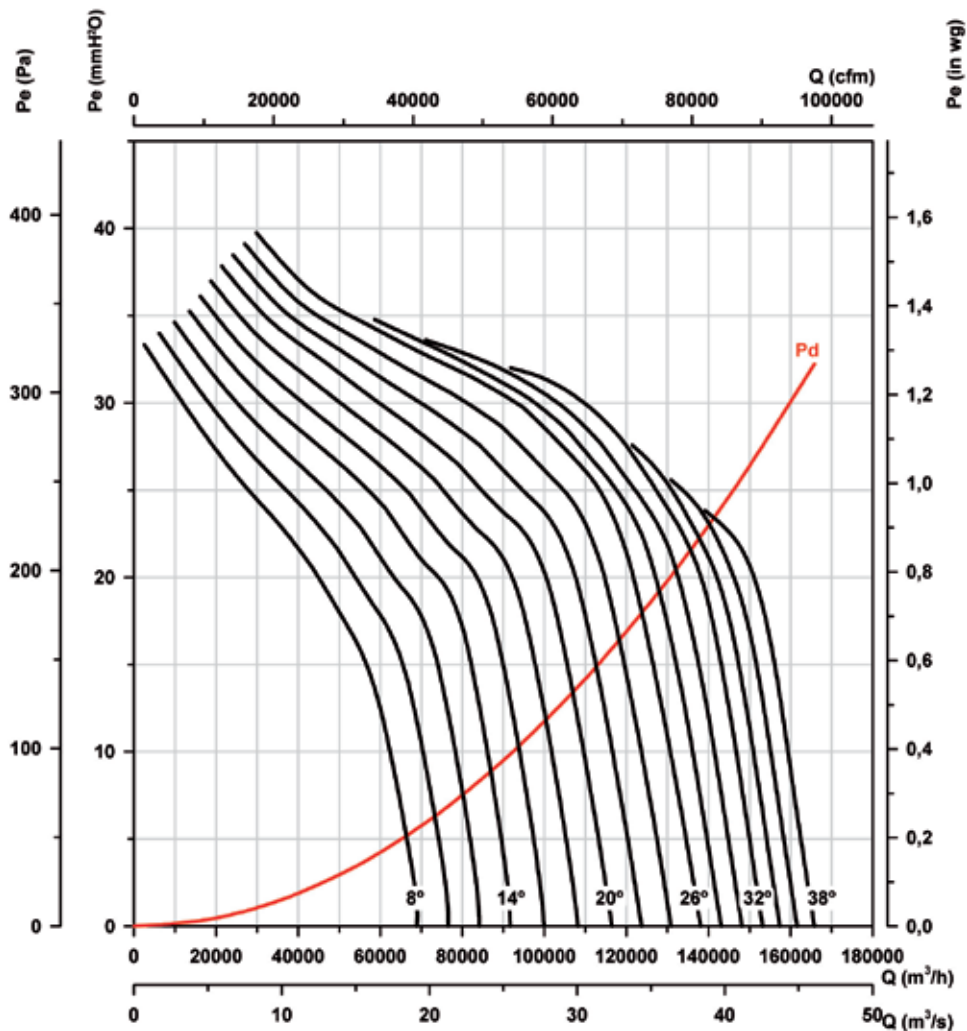

Curvas características

Q= Caudal en m³/h, m³/s y cfm.

Pe= Presión estática en mmH₂O, Pa e inwg.

Diámetro Hélice (cm): 160

Número de polos: 8

Número de palas: 6

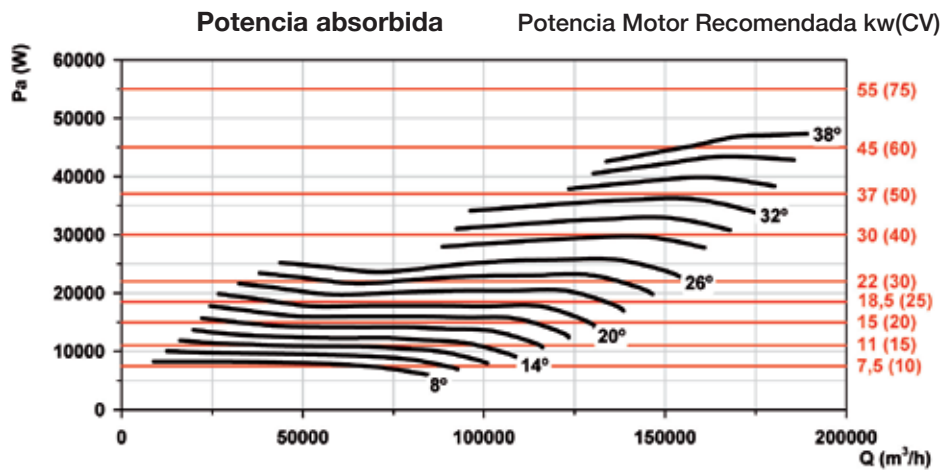
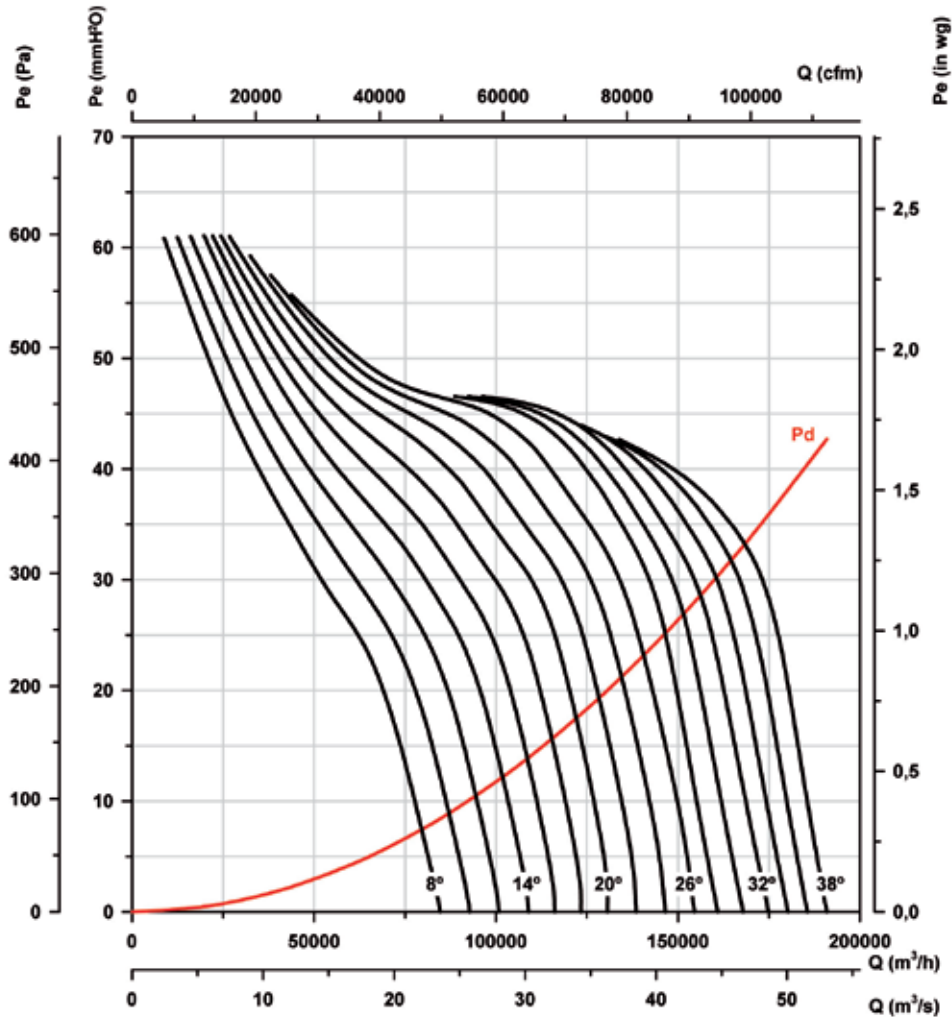

Curvas características

Q= Caudal en m³/h, m³/s y cfm.

Pe= Presión estática en mmH₂O, Pa e inwg.

Diámetro Hélice (cm): 160

Número de polos: 8

Número de palas: 9

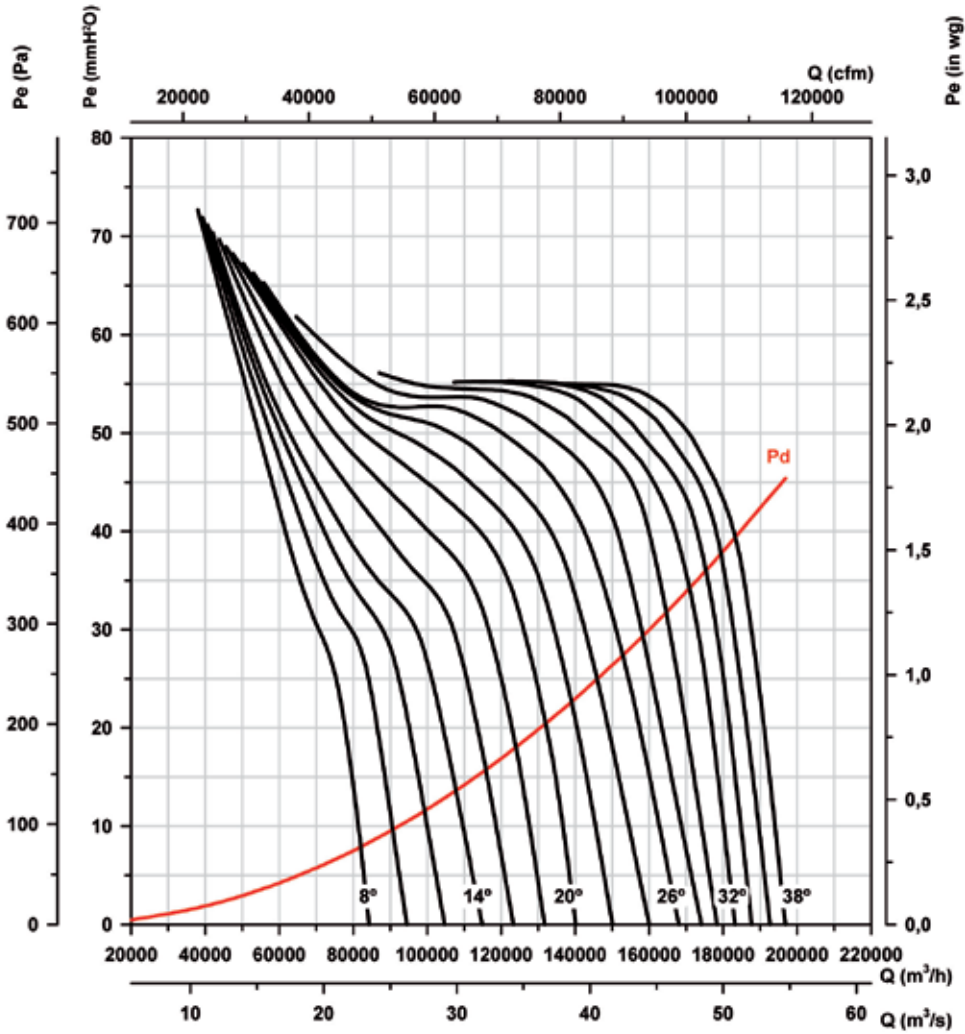

Potencia absorbida

Potencia Motor Recomendada kw(CV)

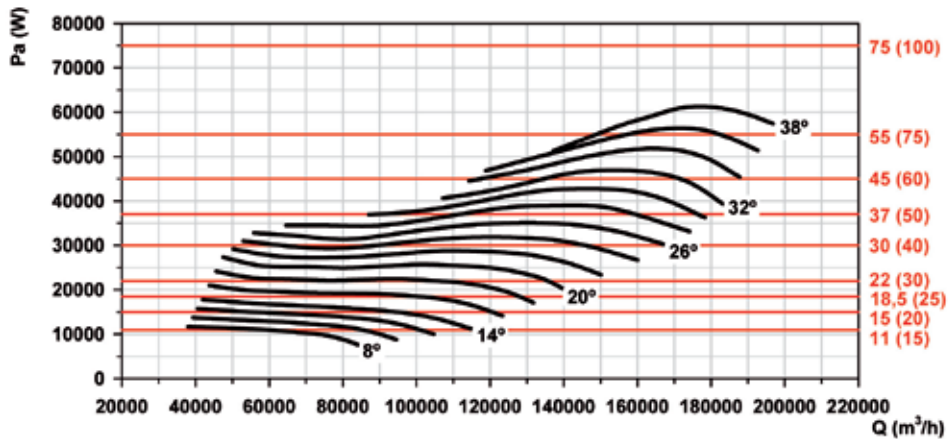

CJTHT

CJTHT: Ventiladores helicoidales 400°C/2h y 300°C/2h. Con caja aislada acústicamente



Unidades de extracción con ventiladores helicoidales para trabajar inmersas en zonas de riesgo de incendios

Ventilador:

- Ventilador con envoltorio tubular en chapa de acero.
- Estructura en chapa de acero galvanizado, con aislamiento térmico y acústico.
- Hélices de ángulo variable en fundición de aluminio.
- Homologación según norma EN 12101-3, con certificaciones: 0370-CPR-0312 (F400) y 0370-CPR-0974 (F300).



Motor:

- Motores clase H para uso continuo S1 y uso emergencia S2. Con rodamientos a bolas, protección IP55 y 1 ó 2 velocidades según modelo
- Motor Multitensión, diseño especial válido para: 220/380V 60Hz, 254/440V 60Hz, 265/460V 60Hz, 277/480V 60Hz
- Temperatura máxima del aire a transportar: Servicio S1 -20°C+ 40°C en continuo. Servicio S2 300°C/2h. 400°C/2h

gico libre de fosfatos

- Caja: anticorrosivo en chapa de acero galvanizado

Bajo demanda:

- Dirección aire hélice-motor
- Hélices reversibles 100%

Acabado:

- Ventilador: Anticorrosivo en resina de poliéster polimerizada a 190°C.. previo desengrase con tratamiento nanotecnológico

Código de pedido

De tamaño 40 a tamaño 100

CJTHT — 56 — 4T — 2 — F-400 — 60Hz

CJTHT: Unidades de extracción helicoidales 400°C/2h y 300°C/2h, con caja aislada acústicamente

Diámetro hélice en cm.

Número de polos motor
2=2900 r/min. 50 Hz
4=1400 r/min. 50 Hz
6=900 r/min. 50 Hz
8=750 r/min. 50 Hz
12=500 r/min. 50 Hz

T=Trifásico

Potencia motor (c.v.)

F-300: Homologación. Probado para 300°C/2h
F-400: Homologación 400°C/2h

Tamaño 125

CJTHT — 125 — 4T / — 9-10 — 15 — F-400 — 60Hz

CJTHT: Unidades de extracción helicoidales 400°C/2h y 300°C/2h, con caja aislada acústicamente

Diámetro hélice en cm.

Número de polos motor
2=2900 r/min. 50 Hz
4=1400 r/min. 50 Hz
6=900 r/min. 50 Hz
8=750 r/min. 50 Hz
12=500 r/min. 50 Hz

T=Trifásico

Número de palas
3 palas
6 palas
9 palas

Angulo inclinación palas

Potencia motor (c.v.)

F-300: Homologación. Probado para 300°C/2h
F-400: Homologación 400°C/2h

Características técnicas

Modelo	Velocidad (r/min)	Intensidad máxima admisible (A)		Potencia instalada (kW)	Ángulo inclinación palas (°)	Caudal máximo (m³/h)	Nivel presión sonora dB(A)	Peso aprox. (Kg)
		220-277 V	380-480 V					
CJTHT-40-2/4T-1.5	3451 / 1708		2,98 / 1,07	1,10 / 0,25	6750/3400	73 / 58	50	
CJTHT-40-2/4T-2	3499 / 1737		4,47 / 1,40	1,50 / 0,37	7350/3650	74 / 59	51	
CJTHT-40-4T-0.75	1690	2,72	1,57	0,55	5800	61	41	
CJTHT-40-6T-0.75	1107	3,12	1,80	0,55	3800	51	49	
CJTHT-40-6/12T-0.75	1107 / 536		1,75 / 0,67	0,55 / 0,09	3800/1750	51 / 36	53	
CJTHT-45-2/4T-2	3499 / 1737		4,47 / 1,40	1,50 / 0,37	8800/4400	75 / 60	53	
CJTHT-45-2/4T-3	3487 / 1720		5,73 / 1,48	2,20 / 0,50	11300/5650	77 / 62	55	
CJTHT-45-4T-0.75	1690	2,72	1,57	0,55	7500	65	43	
CJTHT-45-6T-0.75	1107	3,12	1,80	0,55	6050	53	51	
CJTHT-45-6/12T-0.75	1107 / 536		1,75 / 0,67	0,55 / 0,09	6050/2800	53 / 38	55	
CJTHT-50-2/4T-4	3463 / 1714		6,91 / 2,14	3,00 / 0,80	12100/6050	79 / 64	62	
CJTHT-50-2/4T-6	3469 / 1720		10,38 / 3,39	4,50 / 1,30	15400/7700	80 / 65	78	
CJTHT-50-4T-1	1678	3,02	1,74	0,75	8950	66	50	
CJTHT-50-6T-0.75	1107	3,12	1,80	0,55	9150	55	52	
CJTHT-50-6/12T-0.75	1107 / 536		1,75 / 0,67	0,55 / 0,09	9150/4250	55 / 40	56	
CJTHT-56-2/4T-6	3469 / 1720		10,38 / 3,39	4,50 / 1,30	19650/9800	85 / 69	87	
CJTHT-56-2/4T-12	3469 / 1708		18,73 / 5,74	9,20 / 2,50	27000/13500	86 / 71	153	
CJTHT-56-4T-1	1678	3,02	1,74	0,75	10550	70	59	
CJTHT-56-4T-1.5	1690	4,83	2,79	1,10	12750	71	61	
CJTHT-56-4/8T-1.5	1720 / 839		2,99 / 1,04	1,10 / 0,25	12750/6300	71 / 56	65	
CJTHT-56-4T-2	1696	6,29	3,63	1,50	15000	72	63	
CJTHT-56-4/8T-2	1684 / 839		3,73 / 1,72	1,50 / 0,37	15000/7400	72 / 57	69	
CJTHT-56-6T-0.75	1107	3,12	1,80	0,55	10650	60	61	
CJTHT-56-6/12T-0.75	1107 / 536		1,75 / 0,67	0,55 / 0,09	10650/4950	60 / 45	65	
CJTHT-63-4T-1	1678	3,02	1,74	0,75	13800	70	63	
CJTHT-63-4T-1.5	1690	4,83	2,79	1,10	16550	71	66	
CJTHT-63-4/8T-1.5	1720 / 839		2,99 / 1,04	1,10 / 0,25	16550/8200	71 / 56	69	
CJTHT-63-4T-2	1696	6,29	3,63	1,50	19100	72	67	
CJTHT-63-4/8T-2	1684 / 839		3,73 / 1,72	1,50 / 0,37	19100/9450	72 / 57	74	
CJTHT-63-4T-3	1726	8,68	5,01	2,20	22400	73	73	
CJTHT-63-4/8T-3	1702 / 839		4,93 / 1,82	2,20 / 0,45	22400/11050	73 / 58	87	
CJTHT-63-4T-4	1714	11,11	6,42	3,00	25150	74	78	
CJTHT-63-4/8T-4	1714 / 853		6,71 / 2,40	3,00 / 0,60	25150/12450	74 / 59	91	
CJTHT-63-6T-0.75	1107	3,12	1,80	0,55	14650	63	66	
CJTHT-63-6/12T-0.75	1107 / 536		1,75 / 0,67	0,55 / 0,09	14650/6800	63 / 48	69	
CJTHT-63-6T-1	1119	3,58	2,07	0,75	15900	64	67	
CJTHT-63-6/12T-1	1113 / 518		2,39 / 1,14	0,75 / 0,15	15900/7400	64 / 49	71	
CJTHT-71-4T-1.5	1690	4,83	2,79	1,10	19950	75	82	
CJTHT-71-4/8T-1.5	1720 / 839		2,99 / 1,04	1,10 / 0,25	19950/9850	75 / 60	86	
CJTHT-71-4T-2	1696	6,29	3,63	1,50	19950	76	84	
CJTHT-71-4/8T-2	1684 / 839		3,73 / 1,72	1,50 / 0,37	19950/9850	76 / 61	91	
CJTHT-71-4T-3	1726	8,68	5,01	2,20	25250	78	90	
CJTHT-71-4/8T-3	1702 / 839		4,93 / 1,82	2,20 / 0,45	25250/12450	78 / 63	103	
CJTHT-71-4T-4	1714	11,11	6,42	3,00	28100	79	95	
CJTHT-71-4/8T-4	1714 / 853		6,71 / 2,40	3,00 / 0,60	28100/13900	79 / 64	108	
CJTHT-71-6T-0.75	1107	3,12	1,80	0,55	15400	65	82	
CJTHT-71-6/12T-0.75	1107 / 536		1,75 / 0,67	0,55 / 0,09	15400/7150	65 / 50	86	
CJTHT-71-6T-1	1119	3,58	2,07	0,75	17450	66	84	
CJTHT-71-6/12T-1	1113 / 518		2,39 / 1,14	0,75 / 0,15	17450/8100	66 / 51	87	
CJTHT-71-6T-1.5	1119	5,1	2,95	1,10	20300	67	86	
CJTHT-71-6/12T-1.5	1131 / 559		3,30 / 1,32	1,10 / 0,18	20300/9450	67 / 52	97	
CJTHT-80-4T-3	1726	8,68	5,01	2,20	25050	79	98	
CJTHT-80-4/8T-3	1702 / 839		4,93 / 1,82	2,20 / 0,45	25050/12400	79 / 64	111	

Características técnicas

Modelo	Velocidad (r/min)	Intensidad máxima admisible (A)		Potencia instalada (kW)	Ángulo inclinación palas (°)	Caudal máximo (m³/h)	Nivel presión sonora dB(A)	Peso aprox. (Kg)
		220-277 V	380-480 V					
CJTHT-80-4T-4	1714	11,11	6,42	3,00	27850	80	103	
CJTHT-80-4/8T-4	1714 / 853		6,71 / 2,40	3,00 / 0,60	27850/13750	80 / 65	115	
CJTHT-80-4T-5.5	1708		8,56	4,00	33450	81	113	
CJTHT-80-4/8T-5.5	1726 / 857		9,36 / 2,88	4,00 / 0,80	33450/16550	81 / 66	147	
CJTHT-80-6T-1.5	1119	5,1	2,95	1,10	20100	70	95	
CJTHT-80-6/12T-1.5	1131 / 559		3,30 / 1,32	1,10 / 0,18	20100/9350	70 / 55	105	
CJTHT-80-6T-2	1125	6,81	3,93	1,50	23900	71	99	
CJTHT-80-6/12T-2	1154 / 559		4,43 / 1,65	1,50 / 0,25	23900/11100	71 / 56	113	
CJTHT-80-6T-3	1131	11,11	6,42	2,20	30150	72	113	
CJTHT-80-6/12T-3	1119 / 559		6,24 / 2,39	2,20 / 0,37	30150/14000	72 / 57	118	
CJTHT-80-8T-0.75	821	3,57	2,06	0,55	16550	68	99	
CJTHT-80-8T-1	833	4,87	2,81	0,75	19550	69	111	
CJTHT-90-4T-4	1714	11,11	6,42	3,00	34700	84	127	
CJTHT-90-4/8T-4	1714 / 853		6,71 / 2,40	3,00 / 0,60	34700/17150	84 / 69	139	
CJTHT-90-4T-5.5	1708		8,56	4,00	39900	86	137	
CJTHT-90-4/8T-5.5	1726 / 857		9,36 / 2,88	4,00 / 0,80	39900/19700	86 / 71	171	
CJTHT-90-4T-7.5	1726		12,09	5,50	43350	88	171	
CJTHT-90-4/8T-7.5	1726 / 857		12,42 / 3,59	5,50 / 1,10	43350/21450	88 / 73	190	
CJTHT-90-4T-10	1737		16,28	7,50	50000	89	208	
CJTHT-90-4/8T-9	1726 / 857		17,16 / 4,89	7,50 / 1,50	46850/23150	89 / 74	198	
CJTHT-90-6T-2	1125	6,81	3,93	1,50	28400	75	123	
CJTHT-90-6/12T-2	1154 / 559		4,43 / 1,65	1,50 / 0,25	28400/13200	75 / 60	137	
CJTHT-90-6T-3	1131	11,11	6,42	2,20	32750	76	137	
CJTHT-90-6/12T-3	1119 / 559		6,24 / 2,39	2,20 / 0,37	32750/15250	76 / 61	142	
CJTHT-90-6T-4	1142	13,42	7,75	3,00	38150	77	171	
CJTHT-90-6/12T-4	1142 / 571		7,85 / 2,81	3,00 / 0,55	38150/17750	77 / 62	171	
CJTHT-90-8T-1	833	4,87	2,81	0,75	23150	69	135	
CJTHT-90-8T-2	833	7,21	4,16	1,50	29850	71	139	
CJTHT-90-8T-3	857	9,67	5,58	2,20	35350	72	171	
CJTHT-100-4T-7.5	1726		12,09	5,50	51700	89	179	
CJTHT-100-4/8T-7.5	1726 / 857		12,42 / 3,59	5,50 / 1,10	46950/23200	89 / 74	198	
CJTHT-100-4T-10	1737		16,28	7,50	56400	90	216	
CJTHT-100-4/8T-9	1726 / 857		17,16 / 4,89	7,50 / 1,50	56400/27900	90 / 75	206	
CJTHT-100-4T-15	1743		23,48	11,00	65850	91	251	
CJTHT-100-4/8T-15	1749 / 863		24,47 / 8,96	11,00 / 2,80	65850/32550	91 / 76	251	
CJTHT-100-4T-20	1749		31,62	15,00	72500	92	258	
CJTHT-100-4/8T-20	1749 / 863		33,24 / 13,58	15,00 / 3,80	72500/35850	92 / 77	258	
CJTHT-100-6T-3	1131	11,11	6,42	2,20	36950	80	145	
CJTHT-100-6/12T-3	1119 / 559		6,24 / 2,39	2,20 / 0,37	36950/17200	80 / 65	150	
CJTHT-100-6T-4	1142	13,42	7,75	3,00	43150	81	179	
CJTHT-100-6/12T-4	1142 / 571		7,85 / 2,81	3,00 / 0,55	43150/20050	81 / 66	179	
CJTHT-100-6T-5.5	1142		10,17	4,00	47500	82	187	
CJTHT-100-6/12T-5.5	1154 / 571		10,60 / 3,25	4,00 / 0,65	47500/22100	82 / 67	206	
CJTHT-100-8T-2	833	7,21	4,16	1,50	32550	75	147	
CJTHT-100-8T-3	857	9,67	5,58	2,20	37450	75	179	
CJTHT-100-8T-4	857	12,78	7,38	3,00	43400	76	216	
CJTHT-125-4T/3-10	1737		16,28	7,50	54400	85	395	
CJTHT-125-4/8T/3-9	1726 / 857		17,16 / 4,89	7,50 / 1,50	50550/25000	85 / 65	409	
CJTHT-125-4T/3-15	1743		23,48	11,00	69800	86	450	
CJTHT-125-4/8T/3-15	1749 / 863		24,47 / 8,96	11,00 / 2,80	69800/34500	86 / 66	456	
CJTHT-125-4T/3-20	1749		31,62	15,00	77500	88	457	
CJTHT-125-4/8T/3-20	1749 / 863		33,24 / 13,58	15,00 / 3,80	77500/38300	88 / 68	476	
CJTHT-125-4T/3-25	1749		36,58	18,50	92950	88	540	

Características técnicas

Modelo	Velocidad (r/min)	Intensidad máxima admisible (A)		Potencia instalada (kW)	Ángulo inclinación palas (°)	Caudal máximo (m³/h)	Nivel presión sonora dB(A)	Peso aprox. (Kg)
		220-277 V	380-480 V					
CJTHT-125-4T/3-30	1743 / 863		42,63 / 16,24	22,00 / 5,30	101300	89	545	
CJTHT-125-4/8T/3-27	1749		44,02	22,00	92950/45950	89 / 68	548	
CJTHT-125-4/8T/3-37	1770 / 882		51,00 / 0,60	27,00 / 6,00	118000/58350	90 / 69	625	
CJTHT-125-4T/3-40	1755		58,24	30,00	118000	90	598	
CJTHT-125-4/8T/3-40	1755 / 875		58,87 / 21,24	30,00 / 7,50	118000/58350	90 / 69	638	
CJTHT-125-4T/6-20	1749		31,62	15,00	69250	86	466	
CJTHT-125-4/8T/6-20	1749 / 863		33,24 / 13,58	15,00 / 3,80	73400/36250	86 / 65	485	
CJTHT-125-4/8T/6-22	1749 / 863		33,24 / 13,58	15,00 / 3,80	77500/38300	86 / 66	555	
CJTHT-125-4T/6-25	1749		36,58	18,50	81600	87	549	
CJTHT-125-4/8T/6-27	1749		44,02	22,00	85750/42350	87 / 66	557	
CJTHT-125-4T/6-30	1743 / 863		42,63 / 16,24	22,00 / 5,30	93950	87	554	
CJTHT-125-4/8T/6-37	1770 / 882		51,00 / 0,60	27,00 / 6,00	102200/50500	87 / 67	633	
CJTHT-125-4T/6-40	1755		58,24	30,00	110400	89	606	
CJTHT-125-4/8T/6-40	1755 / 875		58,87 / 21,24	30,00 / 7,50	110400/54600	89 / 68	646	
CJTHT-125-4T/6-50	1770		70,60	37,00	117700	90	734	
CJTHT-125-4T/9-25	1749		36,58	18,50	69850	85	558	
CJTHT-125-4/8T/9-22	1749 / 863		33,24 / 13,58	15,00 / 3,80	59500/29400	85 / 66	564	
CJTHT-125-4T/9-30	1743 / 863		42,63 / 16,24	22,00 / 5,30	85350	86	563	
CJTHT-125-4/8T/9-27	1749		44,02	22,00	75000	86 / 67	566	
CJTHT-125-4/8T/9-37	1770 / 882		51,00 / 0,60	27,00 / 6,00	85350/42200	87 / 67	642	
CJTHT-125-4T/9-40	1755		58,24	30,00	95700	88	615	
CJTHT-125-4/8T/9-40	1755 / 875		58,87 / 21,24	30,00 / 7,50	95700/47300	88 / 68	655	
CJTHT-125-4T/9-50	1770		70,60	37,00	106050	90	743	
CJTHT-125-6T/3-4	1142	13,42	7,75	3,00	35650	77	385	
CJTHT-125-6/12T/3-4	1142 / 571		7,85 / 2,81	3,00 / 0,55	40700/18900	77 / 62	401	
CJTHT-125-6T/3-5.5	1142		10,17	4,00	50800	78	393	
CJTHT-125-6/12T/3-5.5	1154 / 571		10,60 / 3,25	4,00 / 0,65	50800/23600	78 / 63	432	
CJTHT-125-6T/3-7.5	1142		13,56	5,50	60900	79	401	
CJTHT-125-6/12T/3-7.5	1154 / 571		14,40 / 4,77	5,50 / 1,00	60900/28300	79 / 64	445	
CJTHT-125-6T/3-10	1142		18,24	7,50	71850	81	449	
CJTHT-125-6/12T/3-10	1160 / 577		17,82 / 6,74	7,50 / 1,50	71850/33400	81 / 66	457	
CJTHT-125-6T/3-15	1136		23,38	11,00	91650	82	466	
CJTHT-125-6/12T/3-15	1154 / 559		26,31 / 9,57	11,00 / 2,20	91650/42600	82 / 67	557	
CJTHT-125-6T/3-20	1154		31,14	15,00	101650	83	533	
CJTHT-125-6/12T/3-24	1160 / 577		34,71 / 10,46	15,00 / 2,50	104450/48550	83 / 68	623	
CJTHT-125-6T/6-5.5	1142		10,17	4,00	45400	75	402	
CJTHT-125-6/12T/6-5.5	1154 / 571		10,60 / 3,25	4,00 / 0,65	50750/23600	75 / 60	441	
CJTHT-125-6T/6-7.5	1142		13,56	5,50	56150	75	410	
CJTHT-125-6/12T/6-7.5	1154 / 571		14,40 / 4,77	5,50 / 1,00	56150/26100	75 / 60	454	
CJTHT-125-6T/6-10	1142		18,24	7,50	66950	77	458	
CJTHT-125-6/12T/6-10	1160 / 577		17,82 / 6,74	7,50 / 1,50	66950/31150	77 / 62	466	
CJTHT-125-6T/6-15	1136		23,38	11,00	81900	79	475	
CJTHT-125-6/12T/6-15	1154 / 559		26,31 / 9,57	11,00 / 2,20	81900/38100	79 / 64	566	
CJTHT-125-6T/6-20	1154		31,14	15,00	91950	80	542	
CJTHT-125-6/12T/6-24	1160 / 577		34,71 / 10,46	15,00 / 2,50	102550/47700	80 / 65	631	
CJTHT-125-6T/9-10	1142		18,24	7,50	55900	76	467	
CJTHT-125-6/12T/9-10	1160 / 577		17,82 / 6,74	7,50 / 1,50	55900/26000	76 / 61	475	
CJTHT-125-6T/9-15	1136		23,38	11,00	76250	79	484	
CJTHT-125-6/12T/9-15	1154 / 559		26,31 / 9,57	11,00 / 2,20	76250/35450	79 / 64	575	
CJTHT-125-6T/9-20	1154		31,14	15,00	87450	82	551	
CJTHT-125-6/12T/9-24	1160 / 577		34,71 / 10,46	15,00 / 2,50	93050/43250	82 / 67	640	

Dimensiones mm

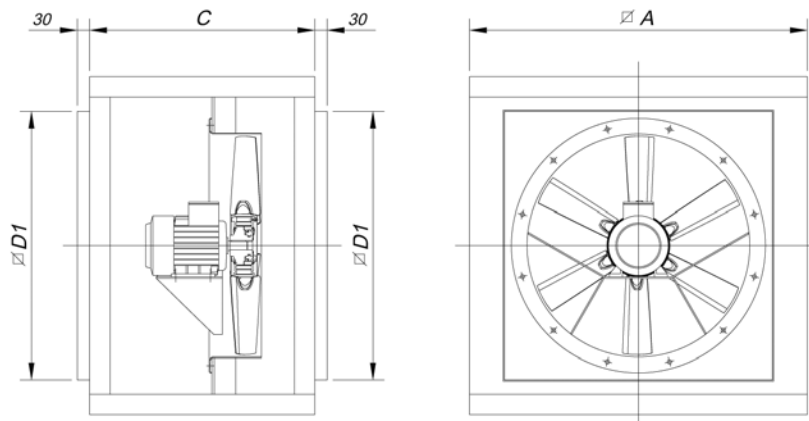

Modelo	∅A	C	∅D1
CJTHT-40/45/50	700	550	565
CJTHT-56/63	825	550	690
CJTHT-71/80	1000	650	850
CJTHT-90/100	1200	750	1050
CJTHT-125	1600	1200	1400

Curvas Características

Ver curvas características en la serie THT

Accesorios

Ver apartado accesorios



INT

IAT

CABLE BOX

C2V

AET

CENTRAL CO

VSD

P-400

THT/IMP

Jet fans de gran alcance 400°C/2h y 300°C/2h, unidireccionales o reversibles



Jet fans de gran alcance 300°C/2h y 400°C/2h unidireccionales o reversibles con diseño circular (THT/IMP-C), octogonal (THT/IMP-L) o octogonal pintada (THT/IMP-O)



THT/IMP-C

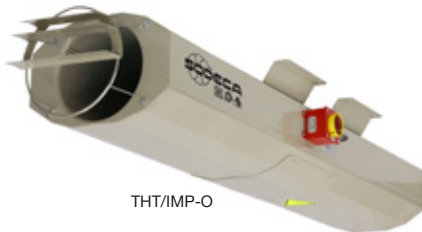

THT/IMP-O

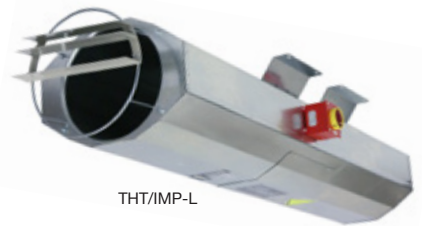

THT/IMP-L

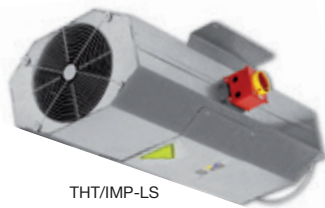

THT/IMP-LS

Ventilador:

- Conjunto de ventilador unidireccional o reversible compuesto de ventilador, silenciadores, deflectores y soportes, homologados para evacuación de humos, según norma EN 12101-3, con certificación N°: 0370-CPR-0394
- Hélices orientables en fundición de aluminio, diseñadas para obtener grandes empujes
- Rejilla de protección contra contactos según norma UNE-EN ISO 12499, en los modelos unidireccionales
- Deflector para aumento de alcance del aire, en el lado de impulsión. Los modelos reversibles van equipados con deflectores en ambos lados.
- Silenciadores de alta atenuación con aislamiento térmico y acústico
- Interruptor de seguridad, serie IAT incorporado en el ventilador (THT/IMP-L y THT/IMP-O) o bajo demanda (THT/IMP-C)
- Dirección aire motor-hélice o reversible 100%
- THT/IMP-C: Envoltorio circular en chapa de acero pintada
- THT/IMP-L: Envoltorio en chapa de acero galvanizada
- THT/IMP-O: Envoltorio en chapa pintada
- THT/IMP-LS: Envoltorio de longitud reducida, en chapa de acero galvanizada

Motor:

- Motores clase H, uso continuo S1 y uso emergencia S2, con rodamientos a bolas, protección IP55, de 2 velocidades
- Motor Multitensión, diseño especial válido para: 220/380V 60Hz, 254/440V 60Hz, 265/460V 60Hz, 277/480V 60Hz
- Temperatura máxima del aire a transportar: Servicio S1 -20°C+ 40°C en continuo, Servicio S2 300°C/2h y 400°C/2h

Acabado:

- Anticorrosivo en resina de poliéster polimerizada a 190 °C, previo desengrase con tratamiento nanotecnológico libre de fosfatos (THT/IMP-C, THT/IMP-O) o anticorrosivo en chapa de acero galvanizado (THT/IMP-L)

Bajo demanda:

- Prestaciones de empuje distintas a las indicadas
- Versión para trabajar fuera de la zona de riesgo de incendio (ver serie HCT/IMP)



Deflector para aumento de alcance

Código de pedido

THT/IMP — O — UNI — 38 — 2/4T — — 1,5 — F-400 — 60Hz

↓	↓	↓	↓	↓	↓	↓	↓
THT/IMP: Jet fans de gran alcance	Diseño C: Envoltorio circular O: Envoltorio pintada L: Envoltorio chapa galvanizada LS: Envoltorio reducida	Dirección del aire UNI: Unidireccional REV: Reversible	Diámetro hélice en cm.	Número de polos motor 2=3500 r/min. 60 Hz 4=1680 r/min. 60 Hz 6=1080 r/min. 60 Hz 8=900 r/min. 60 Hz 12=750 r/min. 60 Hz	T=Trifásico	Potencia motor (c.v)	F-300: Homologación. Probado para 300°C/2h. F-400: Homologación 400°C/2h

Características técnicas

Modelo	Velocidad (r/min)	Intensidad máxima 380-480V (A)	Caudal (m³/h)	Empuje (N)	Velocidad impulsión (m/s)	Potencia instalada (kW)	Presión sonora LpA a 10m dB(A)	Peso aprox. (Kg)
Unidireccional								
THT/IMP-C-UNI-31-2/4T	3432 / 1716	1,50 / 0,55	4260 / 2130	21/ 5	15,6 / 7,8	0,55 / 0,15	51 / 36	65
THT/IMP-C-UNI-35-2/4T	3450 / 1716	2,10 / 0,80	6360 / 3180	36/ 9	17,8 / 8,9	0,85 / 0,20	52 / 37	70
THT/IMP-C-UNI-38-2/4T-1,5	3480 / 1740	2,90 / 1,10	8450 / 4225	57/ 15	20,7 / 10,3	1,10 / 0,25	47 / 32	89
THT/IMP-C-UNI-40-2/4T-1,5	3480 / 1740	2,90 / 1,10	9250 / 4625	60/ 15	20,4 / 10,2	1,10 / 0,25	53 / 38	98
THT/IMP-C-UNI-45-2/4T-2	3528 / 1752	4,40 / 1,40	10800 / 5400	62/ 15	18,1 / 9,0	1,50 / 0,37	57 / 42	132
THT/IMP-C-UNI-45-2/4T-3	3516 / 1740	5,70 / 1,80	13200 / 6600	92/ 23	22,1 / 11,0	2,20 / 0,60	58 / 43	133
THT/IMP-C-UNI-50-2/4T-6	3516 / 1740	10,00 / 3,20	19700 / 9850	165/ 41	26,4 / 13,2	4,50 / 1,30	60 / 45	220
THT/IMP-O-UNI-29-2/4T	3432 / 1716	1,50 / 0,55	4000 / 2000	21/ 5	16,8 / 8,4	0,55 / 0,15	37 / 22	69
THT/IMP-O-UNI-35-2/4T	3450 / 1716	2,10 / 0,80	6360 / 3180	36/ 9	17,8 / 8,9	0,85 / 0,20	52 / 37	70
THT/IMP-O-UNI-38-2/4T-1,5	3480 / 1740	2,90 / 1,10	8450 / 4225	57/ 15	20,7 / 10,3	1,10 / 0,25	47 / 32	94
THT/IMP-O-UNI-40-2/4T-1,5	3480 / 1740	2,90 / 1,10	9250 / 4625	60/ 15	20,4 / 10,2	1,10 / 0,25	53 / 38	104
THT/IMP-O-UNI-45-2/4T-2	3528 / 1752	4,40 / 1,40	10800 / 5400	62/ 15	18,1 / 9,0	1,50 / 0,37	57 / 42	140
THT/IMP-O-UNI-45-2/4T-3	3516 / 1740	5,70 / 1,80	13200 / 6600	92/ 23	22,1 / 11,0	2,20 / 0,60	58 / 43	141
THT/IMP-O-UNI-50-2/4T-6	3516 / 1740	10,00 / 3,20	19700 / 9850	165/ 41	26,4 / 13,2	4,50 / 1,30	60 / 45	234
THT/IMP-L-UNI-29-2/4T	3432 / 1716	1,50 / 0,55	4000 / 2000	21/ 5	16,8 / 8,4	0,55 / 0,15	37 / 22	69
THT/IMP-L-UNI-35-2/4T	3450 / 1716	2,10 / 0,80	6360 / 3180	36/ 9	17,8 / 8,9	0,85 / 0,20	52 / 37	70
THT/IMP-L-UNI-38-2/4T-1,5	3480 / 1740	2,90 / 1,10	8450 / 4225	57/ 15	20,7 / 10,3	1,10 / 0,25	47 / 32	94
THT/IMP-L-UNI-40-2/4T-1,5	3480 / 1740	2,90 / 1,10	9250 / 4625	60/ 15	20,4 / 10,2	1,10 / 0,25	53 / 38	104
THT/IMP-L-UNI-45-2/4T-2	3528 / 1752	4,40 / 1,40	10800 / 5400	62/ 15	18,1 / 9,0	1,50 / 0,37	57 / 42	140
THT/IMP-L-UNI-45-2/4T-3	3516 / 1740	5,70 / 1,80	13200 / 6600	92/ 23	22,1 / 11,0	2,20 / 0,60	58 / 43	141
THT/IMP-L-UNI-50-2/4T-6	3516 / 1740	10,00 / 3,20	19700 / 9850	165/ 41	26,4 / 13,2	4,50 / 1,30	60 / 45	234
THT/IMP-LS-UNI-29-2/4T	3432 / 1716	1,50 / 0,55	4000 / 2000	21/ 5	16,8 / 8,4	0,55 / 0,15	39 / 24	55
THT/IMP-LS-UNI-35-2/4T	3450 / 1716	2,10 / 0,80	6360 / 3180	36/ 9	17,8 / 8,9	0,85 / 0,20	54 / 39	56
THT/IMP-LS-UNI-38-2/4T-1,5	3480 / 1740	2,90 / 1,10	8450 / 4225	57/ 15	20,7 / 10,3	1,10 / 0,25	49 / 34	76
THT/IMP-LS-UNI-40-2/4T-1,5	3480 / 1740	2,90 / 1,10	9250 / 4625	60/ 15	20,4 / 10,2	1,10 / 0,25	55 / 40	83
THT/IMP-LS-UNI-45-2/4T-2	3528 / 1752	4,40 / 1,40	10800 / 5400	62/ 15	18,1 / 9,0	1,50 / 0,37	59 / 44	112
THT/IMP-LS-UNI-45-2/4T-3	3516 / 1740	5,70 / 1,80	13200 / 6600	92/ 23	22,1 / 11,0	2,20 / 0,60	60 / 45	113
THT/IMP-LS-UNI-50-2/4T-6	3516 / 1740	10,00 / 3,20	19700 / 9850	165/ 41	26,4 / 13,2	4,50 / 1,30	62 / 47	187
Reversible								
THT/IMP-C-REV-31-2/4T	3432 / 1716	1,50 / 0,55	3840 / 1920	17/ 4	14,1 / 7,0	0,55 / 0,15	50 / 35	63
THT/IMP-C-REV-35-2/4T	3450 / 1716	2,10 / 0,80	5940 / 2970	31/ 8	16,7 / 8,3	0,85 / 0,20	51 / 36	70
THT/IMP-C-REV-38-2/4T-2	3528 / 1752	4,40 / 1,40	8200 / 4100	54/ 14	20,1 / 10,0	1,50 / 0,37	49 / 34	91
THT/IMP-C-REV-40-2/4T-2	3528 / 1752	4,40 / 1,40	9250 / 4625	60/ 15	20,4 / 10,2	1,50 / 0,37	52 / 37	100
THT/IMP-C-REV-45-2/4T-2	3528 / 1752	4,40 / 1,40	10300 / 5150	56/ 14	17,2 / 8,6	1,50 / 0,37	56 / 41	131
THT/IMP-C-REV-45-2/4T-3	3516 / 1740	5,70 / 1,80	12800 / 6400	87/ 22	21,4 / 10,7	2,20 / 0,60	57 / 42	133
THT/IMP-C-REV-50-2/4T-6	3516 / 1740	10,00 / 3,20	19000 / 9500	153/ 38	25,4 / 12,7	4,50 / 1,30	60 / 45	267
THT/IMP-O-REV-29-2/4T	3432 / 1716	1,50 / 0,55	3400 / 1700	15/ 4	14,3 / 7,1	0,55 / 0,15	38 / 23	67
THT/IMP-O-REV-35-2/4T	3450 / 1716	2,10 / 0,80	5940 / 2970	31/ 8	16,7 / 8,3	0,85 / 0,20	51 / 36	70
THT/IMP-O-REV-38-2/4T-2	3528 / 1752	4,40 / 1,40	8200 / 4100	54/ 14	20,1 / 10,0	1,50 / 0,37	49 / 34	97
THT/IMP-O-REV-40-2/4T-2	3528 / 1752	4,40 / 1,40	9250 / 4625	60/ 15	20,4 / 10,2	1,50 / 0,37	52 / 37	106
THT/IMP-O-REV-45-2/4T-2	3528 / 1752	4,40 / 1,40	10300 / 5150	56/ 14	17,2 / 8,6	1,50 / 0,37	56 / 41	139
THT/IMP-O-REV-45-2/4T-3	3516 / 1740	5,70 / 1,80	12800 / 6400	87/ 22	21,4 / 10,7	2,20 / 0,60	57 / 42	141
THT/IMP-O-REV-50-2/4T-6	3516 / 1740	10,00 / 3,20	19000 / 9500	153/ 38	25,4 / 12,7	4,50 / 1,30	60 / 45	284
THT/IMP-L-REV-29-2/4T	3432 / 1716	1,50 / 0,55	3400 / 1700	15/ 4	14,3 / 7,1	0,55 / 0,15	38 / 23	67
THT/IMP-L-REV-35-2/4T	3450 / 1716	2,10 / 0,80	5940 / 2970	31/ 8	16,7 / 8,3	0,85 / 0,20	51 / 36	70
THT/IMP-L-REV-38-2/4T-2	3528 / 1752	4,40 / 1,40	8200 / 4100	54/ 14	20,1 / 10,0	1,50 / 0,37	49 / 34	97
THT/IMP-L-REV-40-2/4T-2	3528 / 1752	4,40 / 1,40	9250 / 4625	60/ 15	20,4 / 10,2	1,50 / 0,37	52 / 37	106
THT/IMP-L-REV-45-2/4T-2	3528 / 1752	4,40 / 1,40	10300 / 5150	56/ 14	17,2 / 8,6	1,50 / 0,37	56 / 41	139
THT/IMP-L-REV-45-2/4T-3	3516 / 1740	5,70 / 1,80	12800 / 6400	87/ 22	21,4 / 10,7	2,20 / 0,60	57 / 42	141
THT/IMP-L-REV-50-2/4T-6	3516 / 1740	10,00 / 3,20	19000 / 9500	153/ 38	25,4 / 12,7	4,50 / 1,30	60 / 45	284
THT/IMP-LS-REV-29-2/4T	3432 / 1716	1,50 / 0,55	3400 / 1700	15/ 4	14,3 / 7,1	0,55 / 0,15	40 / 25	55
THT/IMP-LS-REV-35-2/4T	3450 / 1716	2,10 / 0,80	5940 / 2970	31/ 8	16,7 / 8,3	0,85 / 0,20	53 / 38	56
THT/IMP-LS-REV-38-2/4T-2	3528 / 1752	4,40 / 1,40	8200 / 4100	54/ 14	20,1 / 10,0	1,50 / 0,37	51 / 36	77
THT/IMP-LS-REV-40-2/4T-2	3528 / 1752	4,40 / 1,40	9250 / 4625	60/ 15	20,4 / 10,2	1,50 / 0,37	53 / 39	85
THT/IMP-LS-REV-45-2/4T-2	3528 / 1752	4,40 / 1,40	10300 / 5150	56/ 14	17,2 / 8,6	1,50 / 0,37	58 / 43	111
THT/IMP-LS-REV-45-2/4T-3	3516 / 1740	5,70 / 1,80	12800 / 6400	87/ 22	21,4 / 10,7	2,20 / 0,60	59 / 44	113
THT/IMP-LS-REV-50-2/4T-6	3516 / 1740	10,00 / 3,20	19000 / 9500	153/ 38	25,4 / 12,7	4,50 / 1,30	62 / 47	227

Dimensiones mm

C: Envoltete circular

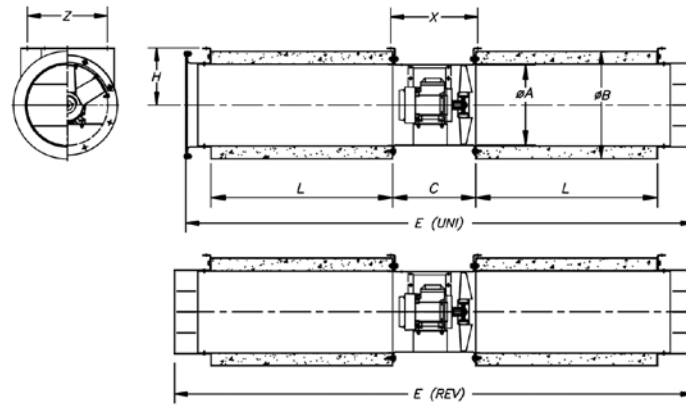

Modelo	$\varnothing A$	$\varnothing B$	C	L	$\varnothing d$	E (UNI)	E (REV)	H	X	Z
THT/IMP-C-31	315	415	320	700	10	1956	2000	220	345	275
THT/IMP-C-35	355	460	325	700	12	1960	2005	250	346	300
THT/IMP-C-38	380	415	340	1000	12	2570	2620	225	530	517
THT/IMP-C-40	410	510	340	950	12	2485	2540	280	376	340
THT/IMP-C-45	460	630	360	950	12	2500	2554	355	396	440

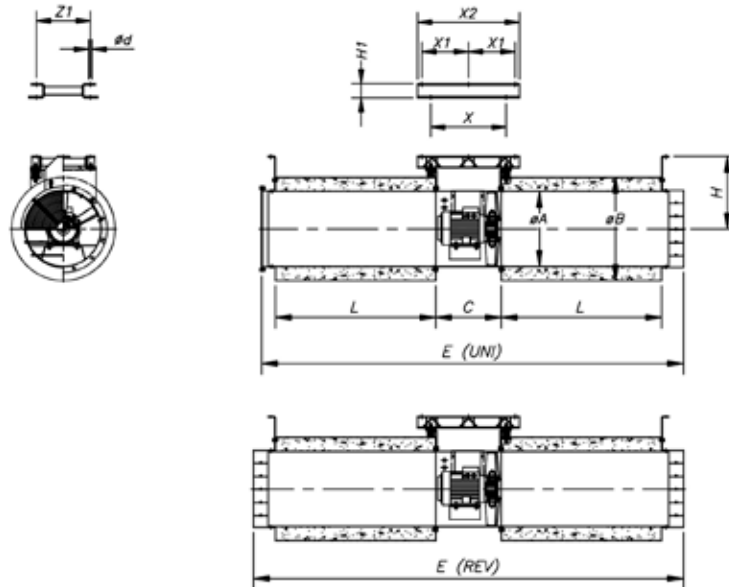

Modelo	$\varnothing A$	$\varnothing B$	C	L	$\varnothing d$	E (UNI)	E (REV)	H	H1-	X	X1	X2	Z	Z1
THT/IMP-C-50	514	710	450	1100	12	2895	2950	498	80	518	320	700	380	370

O: Envoltorio pintado
 L: Envoltorio chapa galvanizada
 LS: Envoltorio reducida

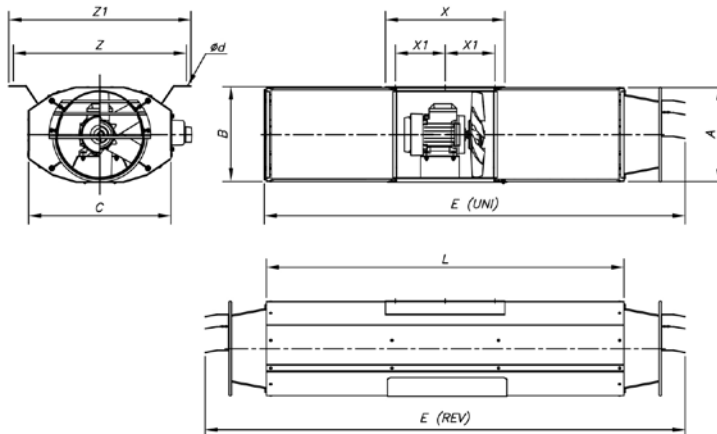

	A	B	C	ød	E (UNI)	E (REV)	L	X	X1	Z	Z1
THT/IMP-LS-29	319,5	324	479	12x26	1410	1610	1200	400	167	580	610
THT/IMP-L-29	319,5	324	479	12x26	2210	2410	2000	400	167	580	610
THT/IMP-O-29	319,5	324	479	12x26	2210	2410	2000	400	167	580	610
THT/IMP-LS-35	383	386	523	12x26	1410	1610	1200	400	167	614	644
THT/IMP-L-35	383	386	523	12x26	2210	2410	2000	400	167	614	644
THT/IMP-O-35	383	386	523	12x26	2210	2410	2000	400	167	614	644
THT/IMP-LS-38	406	409	550	12x26	1410	1610	1200	400	170	640	670
THT/IMP-L-38	406	409	550	12x26	2210	2410	2000	400	170	640	670
THT/IMP-O-38	406	409	550	12x26	2210	2410	2000	400	170	640	670
THT/IMP-LS-40	436	439	582	12x26	1410	1610	1200	400	170	670	700
THT/IMP-L-40	436	439	582	12x26	2210	2410	2000	400	170	670	700
THT/IMP-O-40	436	439	582	12x26	2210	2410	2000	400	170	670	700
THT/IMP-LS-45	486	489	630	12x26	1410	1610	1200	400	170	724	754
THT/IMP-L-45	486	489	630	12x26	2210	2410	2000	400	170	724	754
THT/IMP-O-45	486	489	630	12x26	2210	2410	2000	400	170	724	754
THT/IMP-LS-50	546	549	742	12x26	1445	1675	1200	580	255	778	808
THT/IMP-L-50	546	549	742	12x26	2245	2475	2000	580	255	778	808
THT/IMP-O-50	546	549	742	12x26	2245	2475	2000	580	255	778	808

Aplicación en garajes

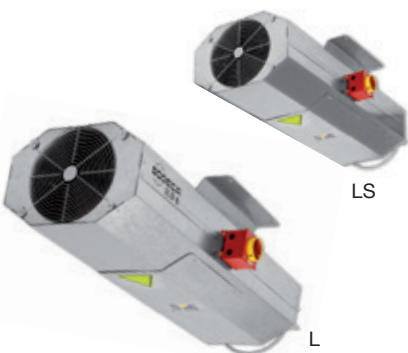

Accesorios



CI



Caja de conexiones en el exterior
Pies fijación

Jet fans centrífugos de inducción y de gran alcance 300°C/2h y 400°C/2h, para trabajar dentro de la zona de riesgo de incendio, con bajo perfil

Jet fans centrífugos de inducción y de gran alcance 300°C/2h y 400°C/2h, para trabajar dentro de la zona de riesgo de incendio, con bajo perfil

Ventilador:

- Envoltente en chapa de acero
- Turbina con álabes a reacción en chapa de acero de gran robustez
- Caja de conexiones en el exterior
- Pies fijación incluidos

Motor:

- Motores clase H, uso continuo S1 y uso emergencia S2, con rodamientos a bolas, protección IP-55 de 1 o 2 velocidades según modelo
- Motor Multitensión, diseño especial válido para: 220/380V 60Hz, 254/440V 60Hz, 265/460V 60Hz, 277/480V 60Hz
- Temperatura máxima del aire a transportar: Servicio S1 -20°C +40°C en continuo, Servicio S2 300°C/2h y 400°C/2h.

Acabado:

- Anticorrosivo en resina de poliéster polimerizada a 190 °C, previo desengrase con tratamiento nanotecnológico libre de fosfatos.

Bajo demanda:

- Versión para trabajar fuera de la zona de riesgo de incendio (ver serie CI-CO)



Código de pedido

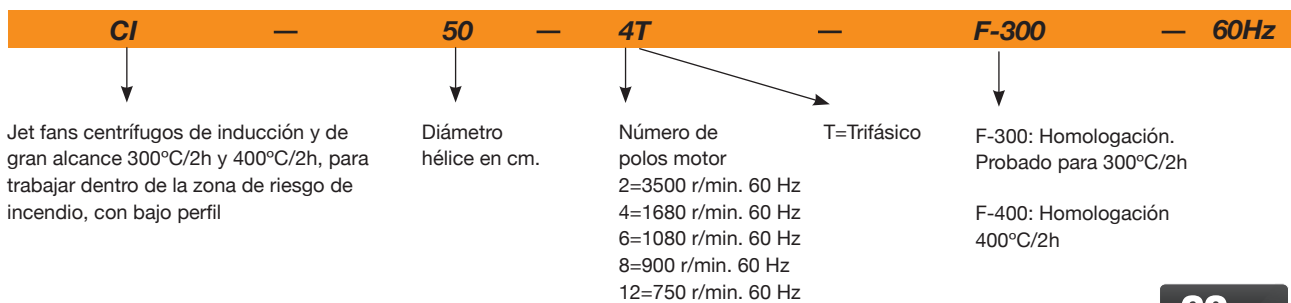

Características técnicas

Modelo	Velocidad (r/min)	Intensidad máxima admisible (A)		Caudal (m³/h)	Empuje (N)	Potencia instalada (kW)	Presión sonora LpA a 1m dB(A)	Peso aprox. (Kg)
		220-277V	380-480V					
CI-50-4T	1674	5,00	2,90	6050	50	1,20	78	83
CI-50-4/8T	1674/780		2,90 / 1,20	6050 / 3020	50 / 13	1,20 / 0,30	78/63	83
CI-75-4T	1740	9,00	5,20	8080	75	2,20	85	139
CI-75-4/8T	1740/876		5,20 / 2,05	8080 / 4040	75 / 19	2,20 / 0,37	85/70	139
CI-100-4T	1734	9,90	5,70	9340	100	2,40	89	141
CI-100-4/8T	1734/858		5,70 / 2,20	9340 / 4670	100 / 25	2,40 / 0,55	89/14	141

Dimensiones mm

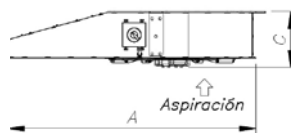
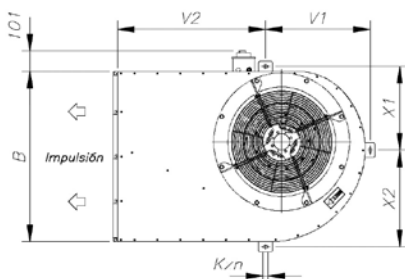

Modelo	A	B	C	V2	V1	X1	X2	Kxn
CI-50-F300	1240	840	272,5	741,5	524,5	413	477	12x26
CI-50-F400	1240	840	261,5	741,5	524,5	413	477	12x26
CI-75-F300	1778	1040	311	1143	662	494	596	12x26
CI-75-F400	1778	1040	299	1143	662	494	596	12x26
CI-100 F-300	1778	1040	323	1143	662	494	596	12x26
CI-100 F-400	1778	1040	323	1143	662	494	596	12x26

Accesorios



HTMF

Extractores de cubierta multifuncional 400°C/2h (F-400) y 300°C/2h (F-300)

Extractores de cubierta multifuncional 400°C/2h, para trabajar inmersos en zonas de riesgo de incendios, diseñados para evacuación de humos en naves industriales o similares

Ventilador:

- Base soporte en chapa de acero galvanizada pintada
- Hélices orientables en fundición de aluminio
- Rejilla de protección contra contactos según norma UNE-EN ISO 12499
- Sombrero en chapa de acero galvanizada pintada, con salida de aire natural. Homologación según norma EN 12101-3, con certificación N° 0370-CPR-0544

Motor:

- Motores clase H, uso continuo S1 y uso emergencia S2, con rodamientos a bolas, protección IP55, de 1 ó 2 velocidades según modelo
- Motor Multitensión, diseño especial válido para: 220/380V 60Hz, 254/440V 60Hz, 265/460V 60Hz, 277/480V 60Hz
- Temperatura máxima del aire a transportar: Servicio S1 -20°C+ 40°C en continuo, Servicio S2 300°C/2h, 400°C/2h

Acabado:

- Anticorrosivo en resina de poliéster polimerizada a 190 °C, previo desengrase con tratamiento nanotecnológico libre de fosfatos.

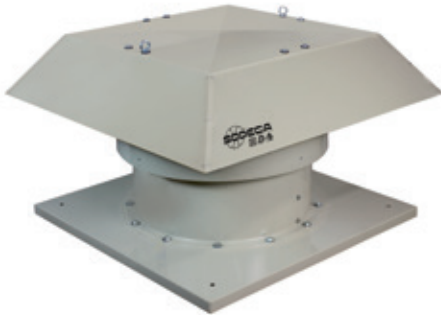

Código de pedido

HTMF	56	4T	2	F-400	60Hz
HTMF: Extractores de cubierta multifuncional 400°C/2h y 300°C/2h	Diámetro hélice en cm.	Número de polos motor 2=3500 r/min. 60 Hz 4=1680 r/min. 60 Hz 6=1080 r/min. 60 Hz 8=900 r/min. 60 Hz 12=750 r/min. 60 Hz	T=Trifásico	Potencia motor (c.v.)	F-300: Homologación 300°C/2h F-400: Homologación 400°C/2h

Características técnicas

60Hz

Modelo	Velocidad (r/min)	Intensidad máxima admisible (A)		Potencia instalada (kW)	Caudal máximo (m³/h)	Nivel presión (1) sonora dB(A)		Peso aprox. (Kg)
		220-277V	380-480V			Aspiración	Descarga	
HTMF-56-4T-1	1716	3,80	2,20	0,75	10545	62	59	65
HTMF-56-4T-1,5	1704	4,70	2,70	1,10	11400	63	60	71
HTMF-56-4/8T-1,5	1728 / 852		2,90 / 1,40	1,10 / 0,25	11400 / 5700	63 / 48	60 / 45	75
HTMF-56-6T-0,75	1116	3,30	1,90	0,55	8170	51	49	64
HTMF-63-4T-1,5	1704	4,70	2,70	1,10	13870	65	62	83
HTMF-63-4/8T-1,5	1728 / 852		2,90 / 1,40	1,10 / 0,25	13870 / 6935	65 / 50	62 / 47	87
HTMF-63-4T-2	1710	6,60	3,80	1,50	15485	66	63	85
HTMF-63-4/8T-2	1698 / 858		3,60 / 1,50	1,50 / 0,30	15485 / 7742	66 / 51	63 / 48	90
HTMF-63-4T-3	1722	9,20	5,30	2,20	17955	67	64	90
HTMF-63-4/8T-3	1698 / 858		5,20 / 1,90	2,20 / 0,45	17955 / 8977	67 / 52	64 / 49	103
HTMF-63-6T-0,75	1116	3,30	1,90	0,55	10260	56	54	76
HTMF-63-6T-1	1128	4,40	2,60	0,75	11305	57	55	85
HTMF-71-4T-2	1710	6,60	3,80	1,50	16150	69	66	90
HTMF-71-4/8T-2	1698 / 858		3,60 / 1,50	1,50 / 0,30	16150 / 8075	69 / 54	66 / 51	96
HTMF-71-4T-3	1722	9,20	5,30	2,20	18430	71	68	96
HTMF-71-4/8T-3	1698 / 858		5,20 / 1,90	2,20 / 0,45	18430 / 9215	71 / 56	68 / 53	109
HTMF-71-4T-4	1716	11,40	6,60	3,00	22610	72	69	100
HTMF-71-4/8T-4	1704 / 846		6,90 / 2,30	3,00 / 0,60	22610 / 11305	72 / 57	69 / 54	111

Características técnicas

Modelo	Velocidad (r/min)	Intensidad máxima admisible (A)		Potencia instalada (kW)	Caudal máximo (m³/h)	Nivel presión (1) sonora dB(A)		Peso aprox. (Kg)
		220-277V	380-480V			Aspiración	Descarga	
HTMF-71-6T-1	1128	4,40	2,60	0,75	13205	58	56	90
HTMF-71-6T-1,5	1134	6,40	3,70	1,10	16245	59	57	92
HTMF-80-4T-4	1716	11,40	6,60	3,00	27600	73	70	123
HTMF-80-4/8T-4	1704 / 846		6,90 / 2,30	3,00 / 0,60	27600 / 13800	73 / 58	70 / 55	134
HTMF-80-4T-5,5	1728		8,40	4,00	30176	74	71	134
HTMF-80-4/8T-5,5	1740 / 864		9,40 / 3,50	4,00 / 0,80	30176 / 15088	74 / 59	71 / 56	138
HTMF-80-6T-1,5	1134	6,40	3,70	1,10	19412	62	60	115
HTMF-80-6T-2	1134	7,40	4,30	1,50	22172	63	61	120
HTMF-80-6T-3	1140	10,30	5,90	2,20	24932	64	62	134
HTMF-80-8T-1	852	4,80	2,80	0,75	16376	61	60	132
HTMF-90-4T-5,5	1728		8,40	4,00	35052	79	76	156
HTMF-90-4/8T-5,5	1740 / 864		9,40 / 3,50	4,00 / 0,80	35052 / 17526	79 / 64	76 / 61	160
HTMF-90-4T-7,5	1716		11,50	5,50	38456	81	78	161
HTMF-90-4/8T-7,5	1746 / 870		12,80 / 4,60	5,50 / 1,10	38456 / 19228	81 / 66	78 / 63	207
HTMF-90-4T-10	1752		17,70	7,50	41308	82	79	225
HTMF-90-4/8T-9	1746 / 870		15,50 / 5,50	6,70 / 1,50	41308 / 20654	82 / 67	79 / 64	215
HTMF-90-6T-3	1140	10,30	5,90	2,20	29256	68	66	156
HTMF-90-6/12T-3	1128 / 564		5,60 / 2,20	2,20 / 0,37	29256 / 14628	68 / 53	66 / 51	161
HTMF-90-6T-4	1134	15,00	8,70	3,00	32016	69	67	164
HTMF-90-6/12T-4	1164 / 570		8,90 / 3,50	3,00 / 0,55	32016 / 16008	69 / 54	67 / 52	188
HTMF-90-8T-1	852	4,80	2,80	0,75	17020	61	60	154
HTMF-90-8T-2	840	9,00	5,20	1,50	19596	63	62	158
HTMF-100-4T-7,5	1716		11,50	5,50	40756	84	81	185
HTMF-100-4/8T-7,5	1746 / 870		12,80 / 4,60	5,50 / 1,10	40756 / 20378	84 / 69	81 / 66	231
HTMF-100-4T-10	1752		17,70	7,50	47564	85	82	249
HTMF-100-4/8T-9	1746 / 870		15,50 / 5,50	6,70 / 1,50	44528 / 22264	84 / 69	81 / 66	239
HTMF-100-4T-15	1746		23,00	11,00	51336	86	83	268
HTMF-100-4/8T-14	1764 / 870		23,20 / 8,70	11,00 / 2,80	48300 / 24150	85 / 70	82 / 67	280
HTMF-100-6T-3	1140	10,30	5,90	2,20	32476	74	72	180
HTMF-100-6/12T-3	1128 / 564		5,60 / 2,20	2,20 / 0,37	32476 / 16238	74 / 59	72 / 57	185
HTMF-100-6T-4	1134	15,00	8,70	3,00	35420	75	73	188
HTMF-100-6/12T-4	1164 / 570		8,90 / 3,50	3,00 / 0,55	35420 / 17710	75 / 60	73 / 58	212
HTMF-100-6T-5,5	1164		11,00	4,00	40020	76	74	212
HTMF-100-6/12T-5,5	1164 / 576		11,30 / 4,20	4,00 / 0,65	40020 / 20010	76 / 61	74 / 59	239
HTMF-100-8T-3	846	13,20	7,60	2,20	26404	69	68	189
HTMF-100-8T-4	852	15,60	9,00	3,00	28704	70	69	249
HTMF-THT-125-4T/3-10	1752		13,90	7,50	55250	75	72	333
HTMF-THT-125-4T/3-15	1764		20,90	11,00	72150	76	73	372
HTMF-THT-125-4T/3-20	1758		27,90	15,00	83120	78	75	394
HTMF-THT-125-4T/6-15	1764		20,90	11,00	66800	76	73	388
HTMF-THT-125-4T/6-20	1758		27,90	15,00	72900	76	73	410
HTMF-THT-125-4T/9-20	1758		27,90	15,00	76310	75	72	425
HTMF-THT-125-6T/6-5,5	1164		11,00	4,00	47760	63	61	347
HTMF-THT-125-6T/6-7,5	1164		14,00	5,50	55600	63	61	384
HTMF-THT-125-6T/6-10	1170		14,80	7,50	66170	65	63	393
HTMF-THT-125-6T/6-15	1170		21,90	11,00	76380	67	65	415
HTMF-THT-125-6T/9-7,5	1164		14,00	5,50	50000	64	62	399
HTMF-THT-125-6T/9-10	1170		14,80	7,50	59340	64	62	408
HTMF-THT-125-6T/9-15	1170		21,90	11,00	71890	67	65	430
HTMF-THT-125-6T/9-20	1170		28,20	15,00	83660	70	68	475
HTMF-THT-125-8T/6-4	852	15,60	9,00	3,00	47510	56	55	384
HTMF-THT-125-8T/6-5,5	852		13,00	4,00	52770	58	57	404
HTMF-THT-125-8T/6-7,5	852		15,10	5,50	60410	60	59	416
HTMF-THT-125-8T/6-10	858		20,60	7,50	66030	61	60	424
HTMF-THT-125-8T/9-5,5	852		13,00	4,00	51330	58	57	419
HTMF-THT-125-8T/9-7,5	852		15,10	5,50	54480	61	60	431
HTMF-THT-125-8T/9-10	858		20,60	7,50	65660	63	62	439
HTMF-THT-125-8T/9-15	870		21,70	11,00	73870	64	63	445

(1) Los valores de los niveles sonoros, son presiones en dB(A) medidos a 6 metros, en campo libre.

Características acústicas

Valores tomados a la aspiración con caudal máximo.

Valores tomados a la descarga con caudal máximo.

Espectro de potencia sonora Lw(A) en dB(A) por banda de frecuencia en Hz																	
Modelo	63	125	250	500	1000	2000	4000	8000	Modelo	63	125	250	500	1000	2000	4000	8000
56-4-1	46	67	74	79	82	78	71	60	56-4-1	43	64	71	76	79	75	68	57
56-4-1,5	47	68	75	80	83	79	72	61	56-4-1,5	44	65	72	77	80	76	69	58
56-6-0,75	35	56	63	68	71	67	60	49	56-6-0,75	33	54	61	66	69	65	58	47
56-8-1,5	32	53	60	65	68	64	57	46	56-8-1,5	29	50	57	62	65	61	54	43
63-4-1,5	49	70	77	82	85	81	74	63	63-4-1,5	46	67	74	79	82	78	71	60
63-4-2	50	71	78	83	86	82	75	64	63-4-2	47	68	75	80	83	79	72	61
63-4-3	51	72	79	84	87	83	76	65	63-4-3	48	69	76	81	84	80	73	62
63-6-0,75	40	61	68	73	76	72	65	54	63-6-0,75	38	59	66	71	74	70	63	52
63-6-1	41	62	69	74	77	73	66	55	63-6-1	39	60	67	72	75	71	64	53
63-8-1,5	34	55	62	67	70	66	59	48	63-8-1,5	31	52	59	64	67	63	56	45
63-8-2	35	56	63	68	71	67	60	49	63-8-2	32	53	60	65	68	64	57	46
63-8-3	36	57	64	69	72	68	61	50	63-8-3	33	54	61	66	69	65	58	47
71-4-2	53	74	81	86	89	85	78	67	71-4-2	50	71	78	83	86	82	75	64
71-4-3	55	76	83	88	91	87	80	69	71-4-3	52	73	80	85	88	84	77	66
71-4-4	56	77	84	89	92	88	81	70	71-4-4	53	74	81	86	89	85	78	67
71-6-1	42	63	70	75	78	74	67	56	71-6-1	40	61	68	73	76	72	65	54
71-6-1,5	43	64	71	76	79	75	68	57	71-6-1,5	41	62	69	74	77	73	66	55
71-8-2	38	59	66	71	74	70	63	52	71-8-2	35	56	63	68	71	67	60	49
71-8-3	40	61	68	73	76	72	65	54	71-8-3	37	58	65	70	73	69	62	51
71-8-4	41	62	69	74	77	73	66	55	71-8-4	38	59	66	71	74	70	63	52
80-4-4	57	78	85	90	93	89	82	71	80-4-4	54	75	82	87	90	86	79	68
80-4-5,5	58	79	86	91	94	90	83	72	80-4-5,5	55	76	83	88	91	87	80	69
80-6-1,5	46	67	74	79	82	78	71	60	80-6-1,5	44	65	72	77	80	76	69	58
80-6-2	47	68	75	80	83	79	72	61	80-6-2	45	66	73	78	81	77	70	59
80-6-3	48	69	76	81	84	80	73	62	80-6-3	46	67	74	79	82	78	71	60
80-8-1	45	66	73	78	81	77	70	59	80-8-1	44	65	72	77	80	76	69	58
80-8-4	42	63	70	75	78	74	67	56	80-8-4	39	60	67	72	75	71	64	53
80-8-5,5	43	64	71	76	79	75	68	57	80-8-5,5	40	61	68	73	76	72	65	54
90-4-5,5	63	84	91	96	99	95	88	77	90-4-5,5	60	81	88	93	96	92	85	74
90-4-7,5	65	86	93	98	101	97	90	79	90-4-7,5	62	83	90	95	98	94	87	76
90-4-9	66	87	94	99	102	98	91	80	90-4-9	63	84	91	96	99	95	88	77
90-4-10	66	87	94	99	102	98	91	80	90-4-10	63	84	91	96	99	95	88	77
90-6-3	52	73	80	85	88	84	77	66	90-6-3	50	71	78	83	86	82	75	64
90-6-4	53	74	81	86	89	85	78	67	90-6-4	51	72	79	84	87	83	76	65
90-8-1	45	66	73	78	81	77	70	59	90-8-1	44	65	72	77	80	76	69	58
90-8-2	47	68	75	80	83	79	72	61	90-8-2	46	67	74	79	82	78	71	60
90-8-5,5	48	69	76	81	84	80	73	62	90-8-5,5	45	66	73	78	81	77	70	59
90-8-7,5	50	71	78	83	86	82	75	64	90-8-7,5	47	68	75	80	83	79	72	61
90-8-9	51	72	79	84	87	83	76	65	90-8-9	48	69	76	81	84	80	73	62
90-12-3	37	58	65	70	73	69	62	51	90-12-3	35	56	63	68	71	67	60	49
90-12-4	38	59	66	71	74	70	63	52	90-12-4	36	57	64	69	72	68	61	50
100-4-7,5	68	89	96	101	104	100	93	82	100-4-7,5	65	86	93	98	101	97	90	79
100-4-9	68	89	96	101	104	100	93	82	100-4-9	65	86	93	98	101	97	90	79
100-4-10	69	90	97	102	105	101	94	83	100-4-10	66	87	94	99	102	98	91	80
100-4-14	69	90	97	102	105	101	94	83	100-4-14	66	87	94	99	102	98	91	80
100-4-15	70	91	98	103	106	102	95	84	100-4-15	67	88	95	100	103	99	92	81
100-6-3	58	79	86	91	94	90	83	72	100-6-3	56	77	84	89	92	88	81	70
100-6-4	59	80	87	92	95	91	84	73	100-6-4	57	78	85	90	93	89	82	71
100-6-5,5	60	81	88	93	96	92	85	74	100-6-5,5	58	79	86	91	94	90	83	72
100-8-3	53	74	81	86	89	85	78	67	100-8-3	52	73	80	85	88	84	77	66
100-8-4	54	75	82	87	90	86	79	68	100-8-4	53	74	81	86	89	85	78	67
100-8-7,5	53	74	81	86	89	85	78	67	100-8-7,5	50	71	78	83	86	82	75	64
100-8-9	53	74	81	86	89	85	78	67	100-8-9	50	71	78	83	86	82	75	64
100-8-14	54	75	82	87	90	86	79	68	100-8-14	51	72	79	84	87	83	76	65
100-12-3	43	64	71	76	79	75	68	57	100-12-3	41	62	69	74	77	73	66	55
100-12-4	44	65	72	77	80	76	69	58	100-12-4	42	63	70	75	78	74	67	56
100-12-5,5	45	66	73	78	81	77	70	59	100-12-5,5	43	64	71	76	79	75	68	57
125-4T/3-10	66	73	84	94	95	90	82	78	125-4T/3-10	63	70	81	91	92	87	79	75
125-4T/3-15	67	74	85	95	96	91	83	79	125-4T/3-15	64	71	82	92	93	88	80	76
125-4T/3-20	69	76	87	97	98	93	85	81	125-4T/3-20	66	73	84	94	95	90	82	78
125-4T/6-15	63	72	87	94	97	91	85	81	125-4T/6-15	60	69	84	91	94	88	82	78
125-4T/6-20	63	72	87	94	97	91	85	81	125-4T/6-20	60	69	84	91	94	88	82	78
125-4T/9-20	62	71	87	93	95	89	84	80	125-4T/9-20	59	68	84	90	92	86	81	77
125-6T/6-5,5	56	66	78	81	83	79	68	64	125-6T/6-5,5	54	64	76	79	81	77	66	62
125-6T/6-7,5	56	66	78	81	83	79	68	64	125-6T/6-7,5	54	64	76	79	81	77	66	62
125-6T/6-10	58	68	80	83	85	81	70	66	125-6T/6-10	56	66	78	81	83	79	68	64
125-6T/6-15	60	70	82	85	87	83	72	68	125-6T/6-15	58	68	80	83	85	81	70	66
125-6T/9-7,5	54	65	79	83	83	81	70	66	125-6T/9-7,5	52	63	77	81	81	79	68	64
125-6T/9-10	54	65	79	83	83	81	70	66	125-6T/9-10	52	63	77	81	81	79	68	64
125-6T/9-15	57	68	82	86	86	84	73	69	125-6T/9-15	55	66	80	84	84	82	71	67
125-6T/9-20	60	71	85	89	89	87	76	72	125-6T/9-20	58	69	83	87	87	85	74	70
125-8T/6-4	50	59	70	75	75	69	58	54	125-8T/6-4	49	58	69	74	74	68	57	53
125-8T/6-5,5	52	61	72	77	77	71	60	56	125-8T/6-5,5	51	60	71	76	76	70	59	55
125-8T/6-7,5	54	63	74	79	79	73	62	58	125-8T/6-7,5	53	62	73	78	78	72	61	57
125-8T/6-10	55	64	75	80	80	74	63	59	125-8T/6-10	54	63	74	79	79	73	62	58
125-8T/9-5,5	49	61	70	76	78	72	61	57	125-8T/9-5,5	48	60	69	75	77	71	60	56
125-8T/9-7,5	52	64	73	79	81	75	64	60	125-8T/9-7,5	51	63	72	78	80	74	63	59
125-8T/9-10	54	66	75	81	83	77	66	62	125-8T/9-10	53	65	74	80	82	76	65	61
125-8T/9-15	55	67	76	82	84	78	67	63	125-8T/9-15	54	66	75	81	83	77	66	62

Dimensiones mm

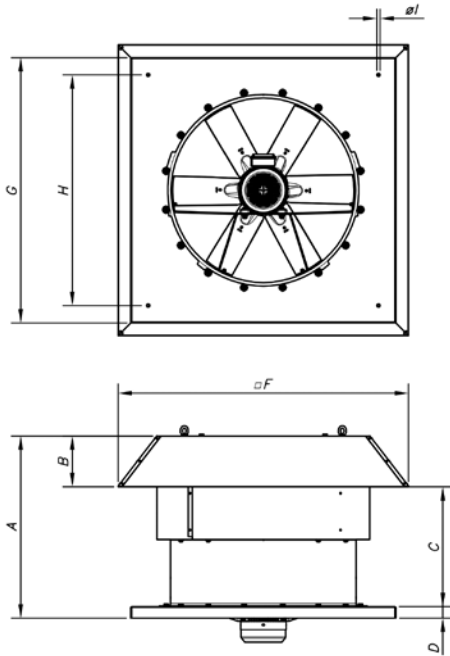

	A	B	C	D	F	G	H	I
HTMF-56	650	185	465	40	960	900	750	14
HTMF-63	680	215	465	40	1092	1000	850	14
HTMF-71	760	195	565	40	1120	1000	850	14
HTMF-80	790	215	575	50	1252	1150	1000	14
HTMF-90	910	232	678	50	1380	1150	1000	14
HTMF-100	1055	252	803	50	1527	1250	1100	14
HTMF-125	1170	310	859	50	1802	1425	1275	17

Validación de la presión sonora según distancia

El nivel sonoro puede variar dependiendo de la estructura de la cubierta o tejado.

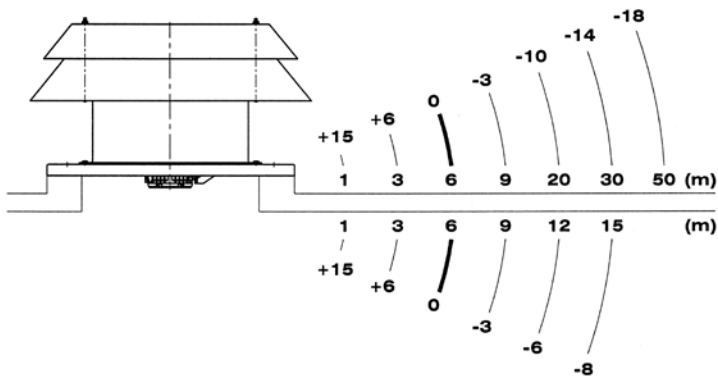

Accesorios

Ver apartado accesorios



Curvas características

Q= Caudal en m³/h, m³/s y cfm.

Pe= Presión estática en mmH₂O, Pa e inwg.

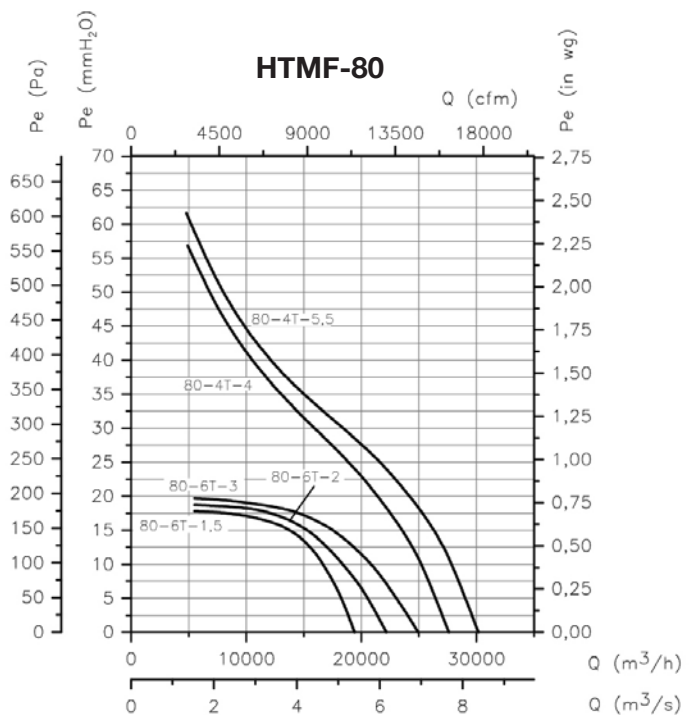
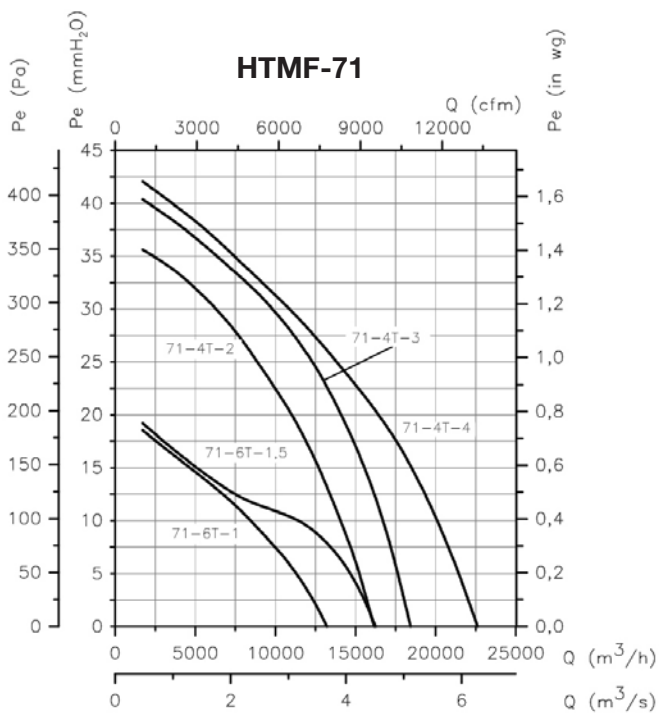
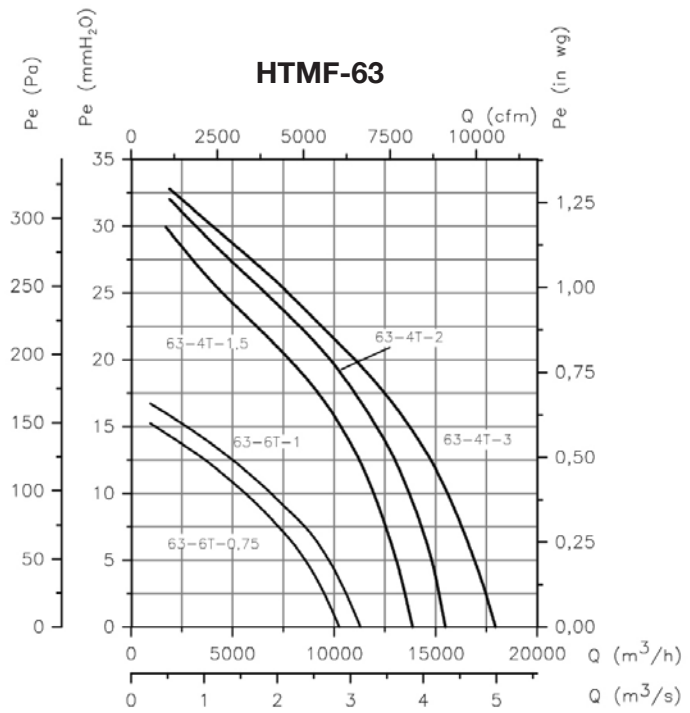
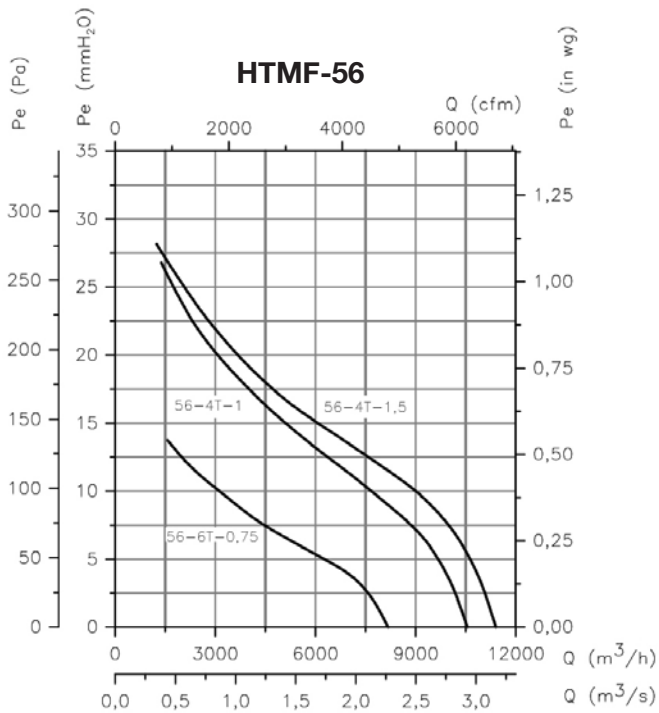

Curvas características

Q= Caudal en m³/h, m³/s y cfm.

Pe= Presión estática en mmH₂O, Pa e inwg.

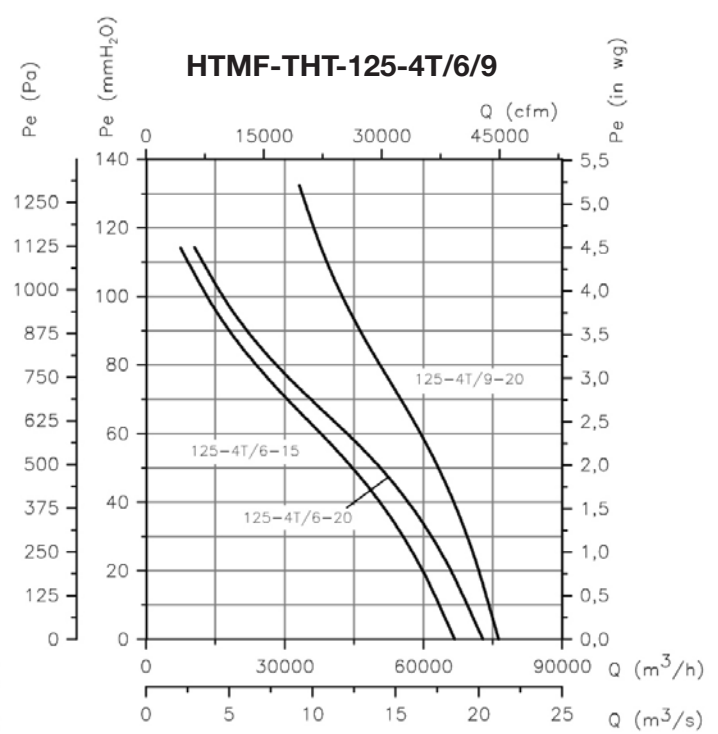
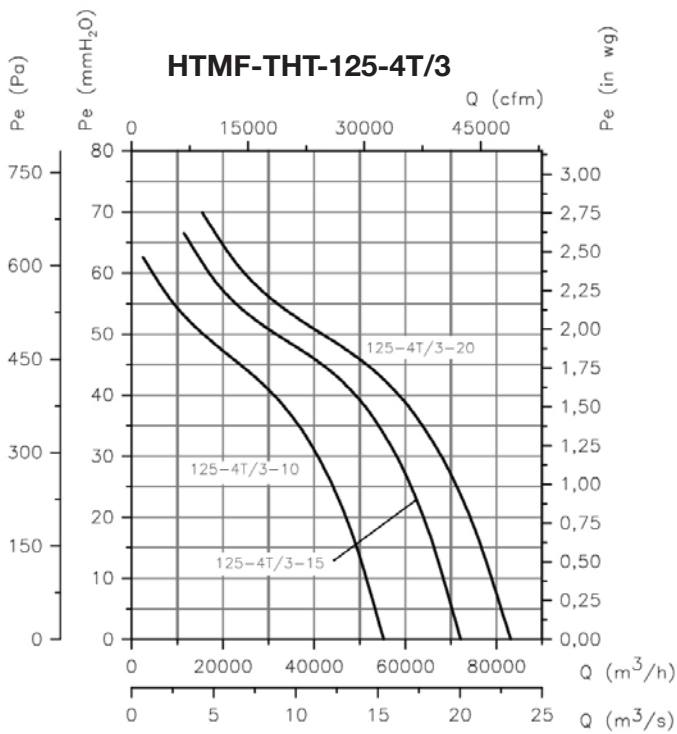
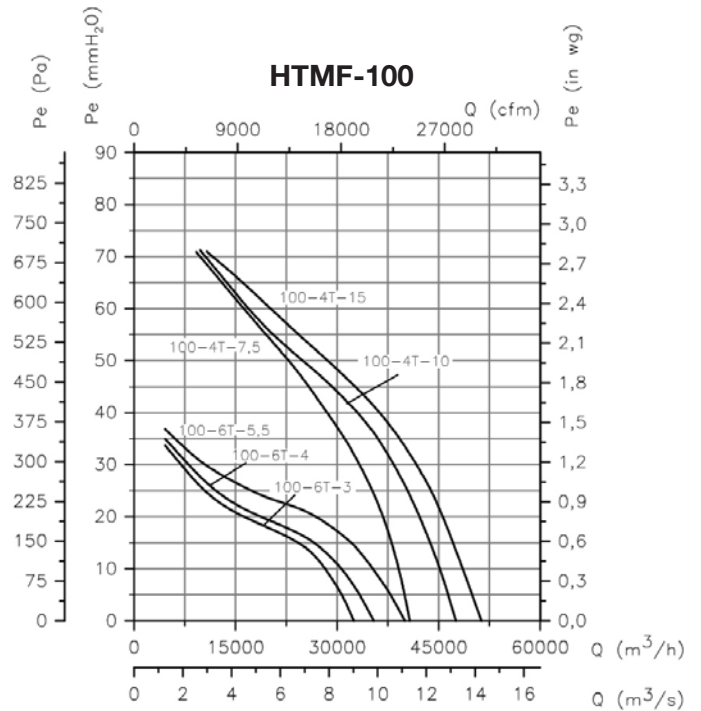
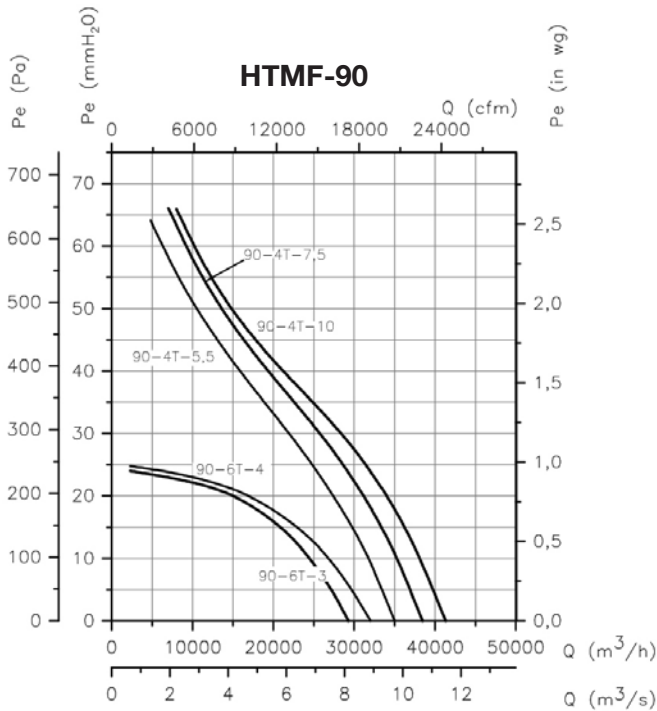

Curvas características

Q= Caudal en m³/h, m³/s y cfm.

Pe= Presión estática en mmH₂O, Pa e inwg.

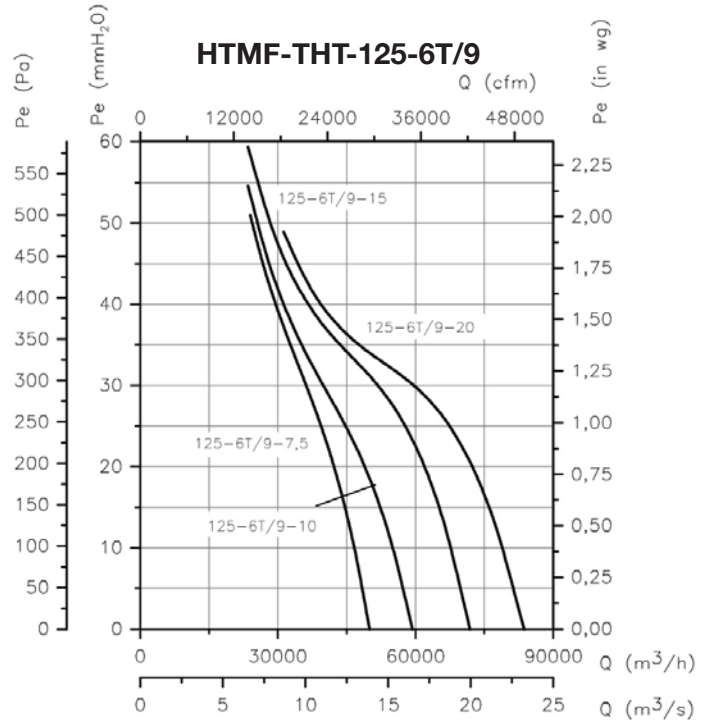
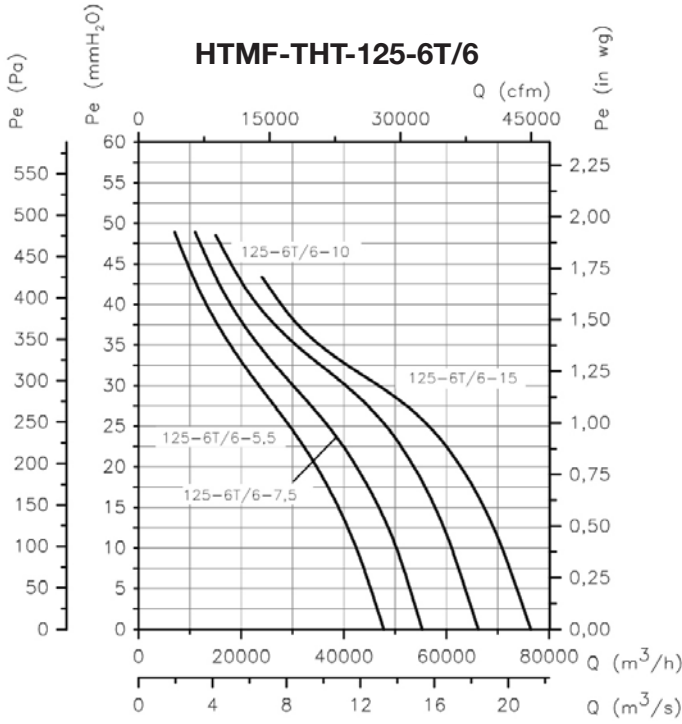

THT/ROOF

Extractores helicoidales de cubierta con salida de aire vertical 400°C/2h y 300°C/2h



Extractores helicoidales de cubierta con salida de aire vertical, para trabajar inmersos en zonas de riesgo de incendios, diseñados para evacuación de humos en naves industriales o similares.

Ventilador:

- Base soporte en chapa de acero galvanizada y tratamiento anticorrosivo.
- Hélices orientables en fundición de aluminio.
- Rejilla de protección contra contactos según norma UNE-EN ISO 12499.
- Compuerta antirretorno en chapa de aluminio para evitar la entrada de agua cuando el ventilador no está en funcionamiento.
- Homologación según norma EN 12101-3. Con certificaciones N°:0370-CPR-0305 (F400), 0370-CPR-0973 (F300).
- Dirección aire motor-hélice.

Motor:

- Motores clase H para uso continuo S1 y uso emergencia S2. Con rodamientos a bolas y protección IP55.
- Motor Multitensión, diseño especial válido para: 220/380V 60Hz, 254/440V 60Hz, 265/460V 60Hz, 277/480V 60Hz
- Temperatura máxima del aire a transportar: Servicio S1 -20°C+40°C en continuo. Servicio S2, 300°C/2h, 400°C/2h

Acabado:

- Anticorrosivo en resina de poliéster polimerizada a 190°C, previo desengrase con tratamiento nanotecnológico libre de fosfatos.

Bajo demanda:

- Extractores con motor de 2 velocidades.
- Ventiladores de 2 y 8 polos según diámetro.



Código de pedido

De tamaño 40 a tamaño 100

THT/ROOF	—	56	—	4T	—	2	—	F400	—	60Hz
THT/ROOF: Extractores helicoidales de cubierta con salida de aire vertical 400°C/2h y 300°C/2h		Diámetro hélice en cm		Número de polos motor T: Trifásico		Potencia motor (c.v.)		F-300: Homologación. Probado para 300°C/2h. F-400: Homologación 400°C/2h		

Tamaño 120

THT/ROOF	—	125	—	4T/9	—	24	—	F400	—	60Hz
THT/ROOF: Extractores helicoidales de cubierta con salida de aire vertical 400°C/2h y 300°C/2h		Diámetro hélice en cm		Número de polos motor T: Trifásico		Número de palas 3 palas 6 palas 9 palas		Potencia motor (c.v.)		F-300: Homologación. Probado para 300°C/2h. F-400: Homologación 400°C/2h

Características técnicas

60Hz

Modelo	Velocidad (r/min)	Intensidad máxima admisible (A)		Potencia instalada (W)	Ángulo inclinación palas (°)	Caudal máximo (m3/h)	Nivel presión sonora dB(A) ⁽¹⁾		Peso aprox. (Kg)
		220-277V	380-480V				Aspiración	Descarga	
THT/ROOF-40-4T-0.75	1704	2,90	1,70	0,55	32	4800	53,55	48,3	39
THT/ROOF-40-6T-0.75	1116	3,30	1,90	0,55	32	3150	42	37,8	44
THT/ROOF-45-4T-0.75	1704	2,90	1,70	0,55	36	7450	57,75	52,5	42
THT/ROOF-45-6T-0.75	1116	3,30	1,90	0,55	30	4450	44,1	39,9	47
THT/ROOF-50-4T-1	1716	3,80	2,20	0,75	28	9750	61,95	56,7	51
THT/ROOF-50-6T-0.75	1116	3,30	1,90	0,55	32	7000	49,35	45,15	54
THT/ROOF-56-4T-1	1716	3,80	2,20	0,75	22	11250	66,15	60,9	58
THT/ROOF-56-4T-1.5	1704	4,70	2,70	1,10	30	13600	67,2	61,95	58
THT/ROOF-56-4T-2	1710	6,60	3,80	1,50	36	15050	68,25	63	61
THT/ROOF-56-6T-0.75	1116	3,30	1,90	0,55	38	10150	54,6	50,4	57
THT/ROOF-63-4T-1.5	1704	4,70	2,70	1,10	20	17800	66,15	61,95	67
THT/ROOF-63-4T-2	1710	6,60	3,80	1,50	24	19300	66,15	61,95	71
THT/ROOF-63-4T-3	1722	9,20	5,30	2,20	32	22150	68,25	64,05	76
THT/ROOF-63-4T-4	1716	11,40	6,60	3,00	38	24250	69,3	65,1	85
THT/ROOF-63-6T-0.75	1116	3,30	1,90	0,55	28	13600	57,75	53,55	67

Características técnicas

Modelo	Velocidad (r/min)	Intensidad máxima admisible (A)		Potencia instalada (W)	Ángulo inclinación palas (°)	Caudal máximo (m3/h)	Nivel presión sonora dB(A) ⁽¹⁾		Peso aprox. (Kg)
		220-277V	380-480V				Aspiración	Descarga	
THT/ROOF-63-6T-1	1128	4,40	2,60	0,75	38	15900	59,85	55,65	70
THT/ROOF-71-4T-2	1710	6,60	3,80	1,50	14	20900	71,4	67,2	78
THT/ROOF-71-4T-3	1722	9,20	5,30	2,20	22	25100	70,35	66,15	83
THT/ROOF-71-4T-4	1716	11,40	6,60	3,00	28	27500	71,4	67,2	92
THT/ROOF-71-6T-0.75	1116	3,30	1,90	0,55	20	16100	58,8	55,65	74
THT/ROOF-71-6T-1	1128	4,40	2,60	0,75	26	17300	59,85	55,65	77
THT/ROOF-71-6T-1.5	1134	6,40	3,70	1,10	34	19950	60,9	56,7	83
THT/ROOF-80-4T-4	1716	11,40	6,60	3,00	16	30250	74,55	70,35	114
THT/ROOF-80-4T-5.5	1728		8,40	4,00	18	32750	74,55	70,35	121
THT/ROOF-80-6T-1.5	1134	6,40	3,70	1,10	18	21450	64,05	59,85	105
THT/ROOF-80-6T-2	1134	7,40	4,30	1,50	26	25950	65,1	60,9	114
THT/ROOF-80-6T-3	1140	10,30	5,90	2,20	32	29950	66,15	61,95	120
THT/ROOF-90-4T-5.5	1728		8,40	4,00	12	38900	78,75	74,55	134
THT/ROOF-90-4T-7.5	1716		11,50	5,50	18	46150	77,7	73,5	161
THT/ROOF-90-4T-10	1752		17,70	7,50	22	50150	76,65	72,45	172
THT/ROOF-90-6T-2	1134	7,40	4,30	1,50	16	28800	67,2	63	127
THT/ROOF-90-6T-3	1140	10,30	5,90	2,20	24	34000	68,25	63	134
THT/ROOF-90-6T-4	1134	15,00	8,70	3,00	30	38900	69,3	65,1	159
THT/ROOF-100-4T-7.5	1716		11,50	5,50	10	46850	82,95	78,75	172
THT/ROOF-100-4T-10	1752		17,70	7,50	16	57400	80,85	76,65	183
THT/ROOF-100-4T-15	1746		23,00	11,00	22	66300	79,8	75,6	236
THT/ROOF-100-4T-20	1752		29,00	15,00	28	76150	81,9	77,7	251
THT/ROOF-100-6T-3	1140	10,30	5,90	2,20	16	37600	70,35	67,2	146
THT/ROOF-100-6T-4	1134	15,00	8,70	3,00	20	41150	70,35	65,1	171
THT/ROOF-100-6T-5.5	1164		11,00	4,00	26	47800	71,4	67,2	183
THT/ROOF-125-4T/3-25	1758		37,00	18,50	20	98350	85,05	79,8	404
THT/ROOF-125-4T/3-30	1764		42,00	22,00	24	110350	86,1	80,85	418
THT/ROOF-125-4T/3-40	1770		58,00	30,00	30	125000	87,15	81,9	499
THT/ROOF-125-4T/6-25	1758		37,00	18,50	14	92550	84	78,75	413
THT/ROOF-125-4T/6-30	1764		42,00	22,00	16	98850	84	78,75	427
THT/ROOF-125-4T/6-40	1770		58,00	30,00	22	117450	86,1	80,85	507
THT/ROOF-125-4T/6-50	1776		73,00	37,00	26	131050	87,15	81,9	543
THT/ROOF-125-4T/9-25	1758		37,00	18,50	10	79650	81,9	76,65	422
THT/ROOF-125-4T/9-30	1764		42,00	22,00	12	88300	82,95	77,7	436
THT/ROOF-125-4T/9-40	1770		58,00	30,00	16	104050	85,05	79,8	516
THT/ROOF-125-4T/9-50	1776		73,00	37,00	20	118400	87,15	81,9	552
THT/ROOF-125-6T/3-4	1134	15,00	8,70	3,00	12	46750	73,5	68,25	267
THT/ROOF-125-6T/3-5.5	1164		11,00	4,00	16	55400	73,5	69,3	279
THT/ROOF-125-6T/3-7.5	1164		14,00	5,50	22	68400	74,55	70,35	286
THT/ROOF-125-6T/3-10	1152		18,60	7,50	28	79150	76,65	72,45	316
THT/ROOF-125-6T/3-15	1146		26,00	11,00	34	87150	77,7	73,5	346
THT/ROOF-125-6T/3-20	1140		35,50	15,00	38	91650	78,75	74,55	404
THT/ROOF-125-6T/6-5.5	1164		11,00	4,00	10	51500	69,3	65,1	288
THT/ROOF-125-6T/6-7.5	1164		14,00	5,50	14	60650	69,3	65,1	295
THT/ROOF-125-6T/6-10	1152		18,60	7,50	20	72650	71,4	67,2	325
THT/ROOF-125-6T/6-15	1146		26,00	11,00	26	85850	73,5	69,3	355
THT/ROOF-125-6T/6-20	1140		35,50	15,00	30	92850	74,55	70,35	413
THT/ROOF-125-6T/9-10	1152		18,60	7,50	14	63500	71,4	67,2	334
THT/ROOF-125-6T/9-15	1146		26,00	11,00	20	77550	74,55	70,35	364
THT/ROOF-125-6T/9-20	1140		35,50	15,00	26	92950	77,7	73,5	422

(1) Los valores de los niveles sonoros, son presiones en dB(A) medidos a 6 metros, en campo libre.

Características acústicas

Espectro de potencia sonora Lw(A) en dB(A) por banda de frecuencia en Hz.

Valores tomados a la aspiración con Caudal máximo

Modelo	63	125	250	500	1000	2000	4000	8000
40-4-0.75	36	57	64	69	72	68	61	50
40-6-0.75	25	46	53	58	61	57	50	39
45-4-0.75	40	61	68	73	76	72	65	54
45-6-0.75	27	48	55	60	63	59	52	41
50-4-1	44	64	72	77	79	76	69	58
50-6-0.75	32	52	60	65	67	64	57	46
56-4-1	48	68	76	81	83	80	73	62
56-4-1.5	49	69	77	82	84	81	74	63
56-4-2	50	70	78	83	85	82	75	64
56-6-0.75	37	57	65	70	72	69	62	51
63-4-1.5	48	68	76	81	83	80	73	65
63-4-2	52	68	76	81	83	80	73	66
63-4-3	53	70	78	83	85	82	77	67
63-4-4	54	71	79	84	86	83	78	68
63-6-0.75	42	60	68	73	75	72	65	56

Valores tomados a la descarga con Caudal máximo

Modelo	63	125	250	500	1000	2000	4000	8000
40-4-0.75	31	52	59	64	67	63	56	45
40-6-0.75	21	42	49	54	57	53	46	35
45-4-0.75	35	56	63	68	71	67	60	49
45-6-0.75	23	44	51	56	59	55	48	37
50-4-1	39	59	67	72	74	71	64	53
50-6-0.75	28	48	56	61	63	60	53	42
56-4-1	43	63	71	76	78	75	68	57
56-4-1.5	44	64	72	77	79	76	69	58
56-4-2	45	65	73	78	80	77	70	59
56-6-0.75	33	53	61	66	68	65	58	47
63-4-1.5	44	64	72	77	79	76	69	60
63-4-2	47	64	72	77	79	76	69	61
63-4-3	48	66	74	79	81	78	73	62
63-4-4	49	67	75	80	82	79	74	63
63-6-0.75	38	56	64	69	71	68	61	52

Características acústicas

Espectro de potencia sonora Lw(A) en dB(A) por banda de frecuencia en Hz.

Valores tomados a la aspiración con Caudal máximo

Modelo	63	125	250	500	1000	2000	4000	8000
63-6-1	43	62	70	75	77	74	67	57
71-4-2	53	73	81	86	88	85	78	70
71-4-3	58	72	80	85	87	84	77	71
71-4-4	59	73	81	86	88	85	78	72
71-6-0.75	44	63	72	74	76	73	66	55
71-6-1	45	65	73	75	77	74	67	56
71-6-1.5	46	66	71	76	78	75	68	57
80-4-4	56	76	84	89	91	88	81	74
80-4-5.5	56	76	84	89	91	88	81	74
80-6-1.5	49	66	74	79	81	78	71	60
80-6-2	50	67	75	80	82	79	72	61
80-6-3	51	68	76	81	83	80	73	62
90-4-5.5	60	81	88	93	96	92	85	74
90-4-7.5	59	80	87	92	95	91	84	73
90-4-10	58	79	86	91	94	90	83	72
90-6-2	49	70	77	82	85	81	74	63
90-6-3	56	70	77	82	85	81	74	63
90-6-4	57	72	79	84	87	83	76	65
100-4-7.5	64	84	92	97	99	96	89	78
100-4-10	62	82	90	95	97	94	87	76
100-4-15	61	81	89	94	96	93	86	75
100-4-20	63	83	91	96	98	95	88	77
100-6-3	61	72	80	85	87	84	77	66
100-6-4	64	72	80	85	87	84	77	66
100-6-5.5	64	73	81	86	88	85	78	67
125-4/3-25	73	79	91	101	101	97	89	85
125-4/3-30	74	80	92	102	102	98	90	86
125-4/3-40	75	81	93	103	103	99	91	87
125-4/6-25	68	76	92	99	101	96	90	86
125-4/6-30	68	76	92	99	101	96	90	86
125-4/6-40	70	78	94	101	103	98	92	88
125-4/6-50	71	79	95	102	104	99	93	89
125-4/9-25	66	74	91	97	98	93	88	84
125-4/9-30	67	75	92	98	99	94	89	85
125-4/9-40	69	77	94	100	101	96	91	87
125-4/9-50	71	79	96	102	103	98	93	89
125-6/3-4	66	74	86	90	88	83	74	70
125-6/3-5.5	66	74	86	90	88	83	74	70
125-6/3-7.5	67	75	87	91	89	84	75	71
125-6/3-10	69	77	89	93	91	86	77	73
125-6/3-15	70	78	90	94	92	87	78	74
125-6/3-20	71	79	91	95	93	88	79	75
125-6/6-5.5	60	69	82	85	86	83	72	68
125-6/6-7.5	60	69	82	85	86	83	72	68
125-6/6-10	62	71	84	87	88	85	74	70
125-6/6-15	64	73	86	89	90	87	76	72
125-6/6-20	65	74	87	90	91	88	77	73
125-6/9-10	58	68	83	87	86	85	74	70
125-6/9-15	61	71	86	90	89	88	77	73
125-6/9-20	64	74	89	93	92	91	80	76

Valores tomados a la descarga con Caudal máximo

Modelo	63	125	250	500	1000	2000	4000	8000
63-6-1	39	58	66	71	73	70	63	53
71-4-2	49	69	77	82	84	81	74	65
71-4-3	53	68	76	81	83	80	73	67
71-4-4	54	69	77	82	84	81	74	68
71-6-0.75	40	60	68	71	73	70	63	52
71-6-1	41	61	69	71	73	70	63	52
71-6-1.5	42	62	67	72	74	71	64	53
80-4-4	52	72	80	85	87	84	77	69
80-4-5.5	52	72	80	85	87	84	77	70
80-6-1.5	45	62	70	75	77	74	67	56
80-6-2	46	63	71	76	78	75	68	57
80-6-3	47	64	72	77	79	76	69	58
90-4-5.5	56	77	84	89	92	88	81	70
90-4-7.5	55	76	83	88	91	87	80	69
90-4-10	54	75	82	87	90	86	79	68
90-6-2	45	66	73	78	81	77	70	59
90-6-3	52	66	73	78	81	77	70	59
90-6-4	53	68	75	80	83	79	72	61
100-4-7.5	60	80	88	93	95	92	85	74
100-4-10	58	78	86	91	93	90	83	72
100-4-15	57	77	85	90	92	89	82	71
100-4-20	59	79	87	92	94	91	84	73
100-6-3	58	69	77	82	84	81	74	63
100-6-4	59	67	75	80	82	79	72	61
100-6-5.5	60	69	77	82	84	81	74	63
125-4/3-25	68	74	86	96	96	92	84	80
125-4/3-30	69	75	87	97	97	93	85	81
125-4/3-40	70	76	88	98	98	94	86	82
125-4/6-25	63	71	87	94	96	91	85	81
125-4/6-30	63	71	87	94	96	91	85	81
125-4/6-40	65	73	89	96	98	93	87	83
125-4/6-50	66	74	90	97	99	94	88	84
125-4/9-25	61	69	86	92	93	88	83	79
125-4/9-30	62	70	87	93	94	89	84	80
125-4/9-40	64	72	89	95	96	91	86	82
125-4/9-50	66	74	91	97	98	93	88	84
125-6/3-4	61	69	81	85	83	78	69	65
125-6/3-5.5	62	70	82	86	84	79	70	66
125-6/3-7.5	63	71	83	87	85	80	71	67
125-6/3-10	65	73	85	89	87	82	73	69
125-6/3-15	66	74	86	90	88	83	74	70
125-6/3-20	67	75	87	91	89	84	75	71
125-6/6-5.5	56	65	78	81	82	79	68	64
125-6/6-7.5	56	65	78	81	82	79	68	64
125-6/6-10	58	67	80	83	84	81	70	66
125-6/6-15	60	69	82	85	86	83	72	68
125-6/6-20	61	70	83	86	87	84	73	69
125-6/9-10	54	64	79	83	82	81	70	66
125-6/9-15	57	67	82	86	85	84	73	69
125-6/9-20	60	70	85	89	88	87	76	72

Dimensiones mm

Modelo	A	B	C	D	ØF	G	H	ØI
THT/ROOF-40	628	349	244	35	519	630	530	12
THT/ROOF-45	642	363	244	35	569	710	590	12
THT/ROOF-50	679	400	244	35	626	900	750	12
THT/ROOF-56	710	426	244	40	686	900	750	14
THT/ROOF-63	747	463	244	40	753	1000	850	14
THT/ROOF-71	830	498	292	40	833	1000	850	14
THT/ROOF-80	887	545	292	50	923	1150	1000	14
THT/ROOF-90	989	601	338	50	1031	1150	1000	14
THT/ROOF-100	1136	648	438	50	1128	1250	1100	14
THT/ROOF-125	1313	775	488	50	1376	1425	1275	17

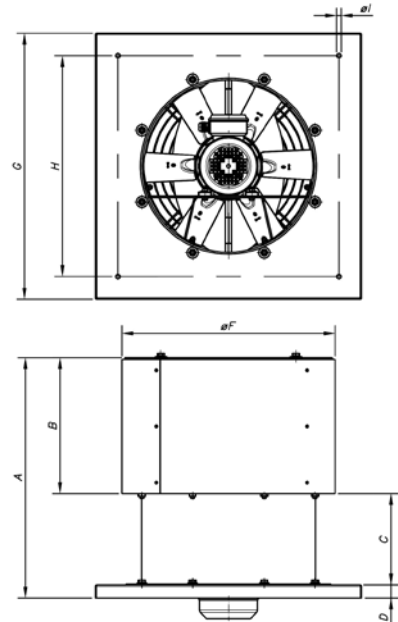

Curvas características

Ver serie HTMV

Accesorios



TCR/R CJTCR/R



TCR/R



CJTCR/R

Extractores centrífugos y unidades de extracción 400°C/2h, con turbina a reacción

TCR/R: Extractores centrífugos 400°C/2h, para trabajar en el exterior de la zona de riesgo de incendios, de simple aspiración y gran robustez, equipados con turbina con álabes hacia atrás

CJTCR/R: Unidades de extracción 400°C/2h con caja aislada acústicamente, para trabajar en el exterior de la zona de riesgo de incendios, de simple aspiración y gran robustez

Ventilador:

- Envoltente en chapa de acero
- Turbina con álabes a reacción, en chapa de acero de gran robustez, con pintura anticorrosiva
- Homologación según norma EN 12101-3, con certificación N°: 0370-CPR-0400 (TCR/R), y N°: 0370-CPR-0401 (CJTCR/R)

Motor:

- Motores clase F, con rodamientos a bolas, protección IP55
- Motor Multitensión, diseño especial válido para: 220/380V 60Hz, 254/440V 60Hz, 265/460V 60Hz, 277/480V 60Hz
- Temperatura máxima del aire a transportar: Servicio S1 -20°C+ 250°C en continuo, Servicio S2 300°C/2h y 400°C/2h

Acabado:

- Anticorrosivo en resina de poliéster polimerizada a 190 °C, previo desengrase con tratamiento nanotecnológico libre de fosfatos.
- CJTCR/R: Anticorrosivo en chapa de acero galvanizado

Bajo demanda:

- Extractores con motor de 2 velocidades
- Extractores a transmisión



Turbina a reacción
de alto rendimiento,
y gran robustez



Código de pedido

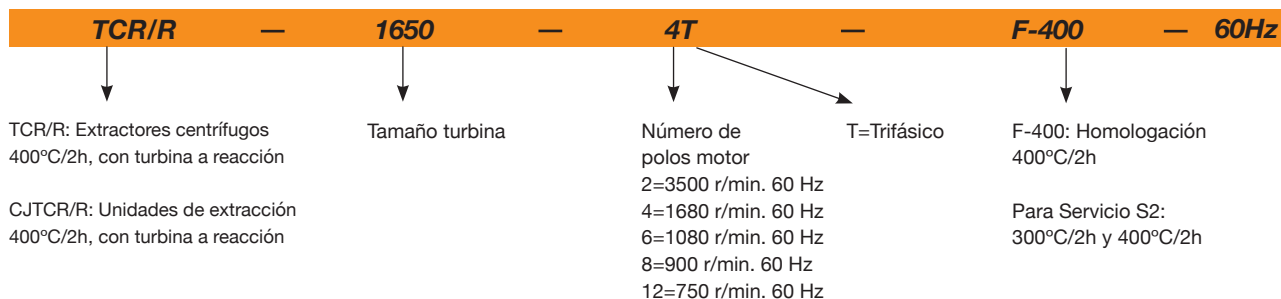

Características técnicas

Modelo	Velocidad (r/min)	Intensidad máxima admisible (A)		Potencia instalada (kW)	Caudal máximo (m3/h)	Nivel presión sonora dB(A)		Peso aprox. (Kg)	
		220-277V	380-480V			TCR/R	CJTCR/R	TCR/R	CJTCR/R
TCR/R CJTCR/R 1240-2T	3474	13,16	7,6	4	11100	86	81	93	147
TCR/R CJTCR/R 1240-4T	1692	3,29	1,9	0,75	5800	71	66	71	125
TCR/R CJTCR/R 1445-2T	3432		13,9	7,5	16500	87	82	126	210
TCR/R CJTCR/R 1445-4T	1692	4,49	2,59	1,1	8030	72	67	93	177
TCR/R CJTCR/R 1650-4T	1704	5,98	3,45	1,5	10500	74	68	114	189
TCR/R CJTCR/R 1650-6T	1116	4,09	2,36	0,75	7410	64	59	111	186
TCR/R CJTCR/R 1856-4T	1716	11,22	6,48	3	15150	79	74	152	273
TCR/R CJTCR/R 1856-6T	1116	5,63	3,25	1,1	10050	70	65	145	266
TCR/R CJTCR/R 2063-4T	1740		11,1	5,5	24450	80	75	225	380
TCR/R CJTCR/R 2063-6T	1140	6,79	3,92	1,5	16100	71	66	209	364
TCR/R CJTCR/R 2271-4T	1752		22	11	34610	85	79	315	508
TCR/R CJTCR/R 2271-6T	1152	11,95	6,9	3	22750	76	71	280	473

Características acústicas

Los valores indicados, se determinan mediante medidas de nivel de presión y potencia sonora en dB(A) obtenidas en campo libre a una distancia equivalente a dos veces la envergadura del ventilador más el diámetro de la turbina, con un mínimo de 1,5 mts.

Espectro de potencia sonora Lw(A) en dB(A) por banda de frecuencia en Hz

Modelo TCR/R	63	125	250	500	1000	2000	4000	8000	Modelo CJTCR/R	63	125	250	500	1000	2000	4000	8000
1240-2	68	83	81	93	90	94	96	83	1240-2	63	78	76	88	85	89	91	78
1240-4	56	40	76	79	79	80	70	59	1240-4	51	65	71	74	74	75	65	54
1445-2	73	85	83	95	93	97	99	89	1445-2	68	80	78	90	88	92	94	84
1445-4	59	72	78	83	80	83	78	64	1445-4	54	67	73	78	75	78	73	59
1650-4	64	74	82	84	83	85	76	66	1650-4	58	68	76	78	77	79	70	60
1650-6	53	65	72	77	73	69	62	54	1650-6	48	60	67	72	68	64	57	49
1856-4	69	78	91	87	90	91	85	71	1856-4	64	73	86	82	85	86	80	66
1856-6	61	69	81	83	80	81	71	60	1856-6	56	64	76	78	75	76	66	55
2063-4	80	85	91	93	91	88	81	73	2063-4	75	80	86	88	86	83	76	68
2063-6	69	70	82	82	81	83	73	63	2063-6	64	65	77	77	76	78	68	58
2271-4	83	84	93	96	98	99	95	82	2271-4	77	78	87	90	92	93	89	76
2271-6	73	73	87	86	90	90	79	68	2271-6	68	68	82	81	85	85	74	63

Orientaciones

Suministro standard LG 270



Dimensiones mm

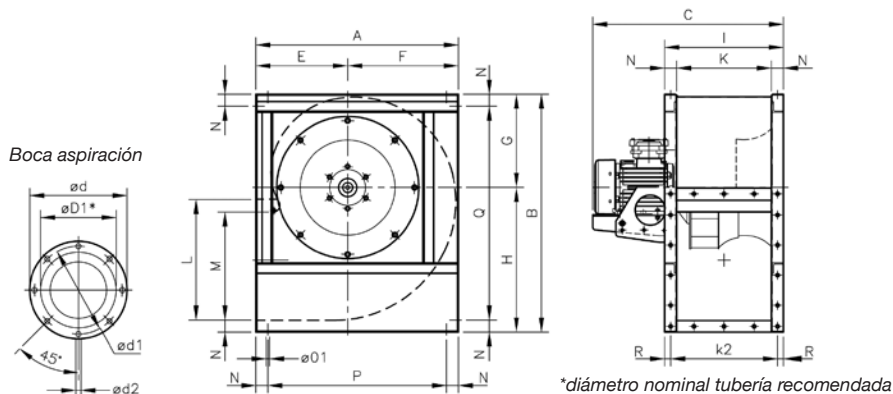

Modelo	A	B	C	ØD1*	Ød	Ød1	Ød2	E	F	G	H	I	M	N	Ø01	P	Q	R
TCR/R 1240-2T	673	790	734	400	472	444	M.8	305	368	310	480	395	358.5	40	11	593	710	20
TCR/R 1240-4T	673	790	634	400	472	444	M.8	305	368	310	480	395	358.5	40	11	593	710	20
TCR/R 1445-2T	765	880	815	450	522	494	M.8	350	415	339	541	445	407	45	11	675	790	20
TCR/R 1445-4T	765	880	727	450	522	494	M.8	350	415	339	541	445	407	45	11	675	790	20
TCR/R 1650-4T	832	970	770.5	500	582	555	M.10	375	457	378	592	490	445	45	13	742	880	20
TCR/R 1650-6T	832	970	770.5	500	582	555	M.10	375	457	378	592	490	445	45	13	742	880	20
TCR/R 1856-4T	925	1084	857.5	560	645	615	M.10	415	510	424	660	550	493	50	13	825	984	25
TCR/R 1856-6T	925	1084	828	560	645	615	M.10	415	510	424	660	550	493	50	13	825	984	25
TCR/R 2063-4T	1037	1218	955	630	720	688	M.10	465	572	477	741	620	530	60	13	917	1098	30
TCR/R 2063-6T	1037	1218	932	630	720	688	M.10	465	572	477	741	620	530	60	13	917	1098	30
TCR/R 2271-4T	1173	1375	1149	710	800	768	M.12	525	648	538	837	690	603.5	65	13	1043	1245	32.5
TCR/R 2271-6T	1173	1375	1112	710	800	768	M.12	525	648	538	837	690	603.5	65	13	1043	1245	32.5

Boca impulsión

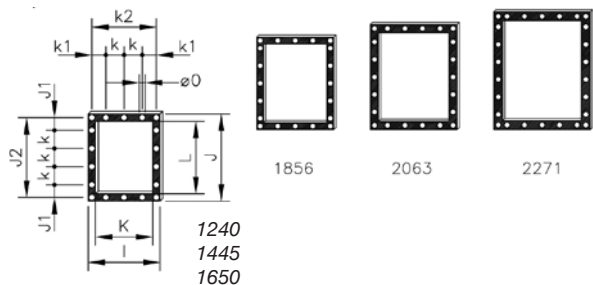

Modelo	I	J	J1	J2	K	k	k1	k2	L	Ø0
TCR/R-1240	395	480	70	440	315	100	77.5	355	400	11
TCR/R-1445	445	540	99	498	355	100	102.5	405	450	11
TCR/R-1650	490	590	87.5	550	400	125	100	450	500	13
TCR/R-1856	550	660	55	610	450	125	125	500	560	13
TCR/R-2063	620	750	95	690	500	125	92.5	560	630	13
TCR/R-2271	690	840	75	775	560	125	62.5	625	710	13

Suministro standard: LG-270

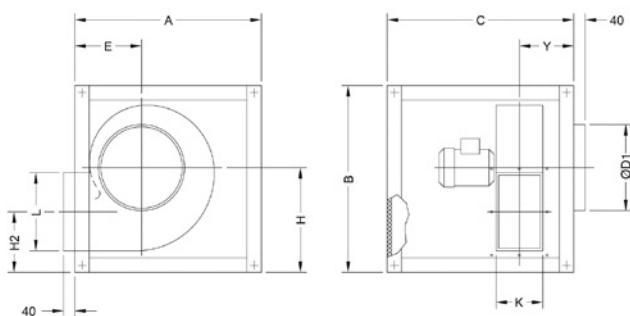

Modelo	A	B	C	ØD1	E	H	H2	K	L	Y
CJTCR/R-1240	970	970	970	400	312	549	308	315	400	307.5
CJTCR/R-1445	1070	1070	1070	450	357	610	339	355	450	333.5
CJTCR/R-1650	1160	1160	1160	500	382	660	365	400	500	355
CJTCR/R-1856	1260	1260	1050	560	422	727	399	450	560	360
CJTCR/R-2063	1400	1400	1200	630	472	810	444	500	630	395
CJTCR/R-2271	1555	1555	1355	710	532	906	560	560	715	430

Dimensiones mm

Suministro bajo demanda: LG-0

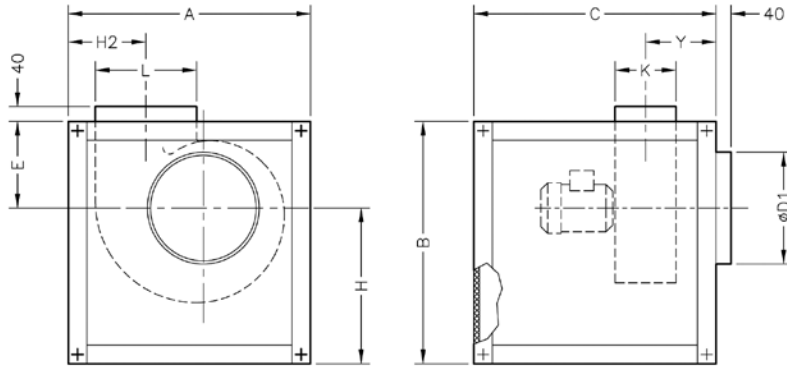

Modelo	A	B	C	ØD1	E	H	H2	K	L	Y
CJTTCR/R-1240	970	970	970	400	533	437	322	315	400	307.5
CJTTCR/R-1445	1070	1070	1070	450	586	484	367	355	450	333.5
CJTTCR/R-1650	1160	1160	1160	500	634.5	525.5	391.5	400	500	355
CJTTCR/R-1856	1260	1260	1050	560	681.5	578.5	442.5	450	560	360
CJTTCR/R-2063	1400	1400	1200	630	759	641	482	500	630	395
CJTTCR/R-2271	1555	1555	1355	710	838	717	518.5	560	715	430

Suministro bajo demanda: LG-90

Detalle taladros boca impulsión

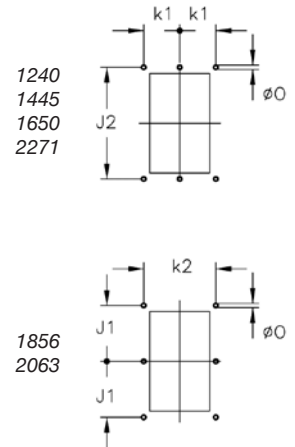
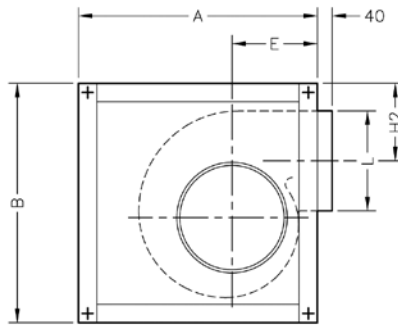
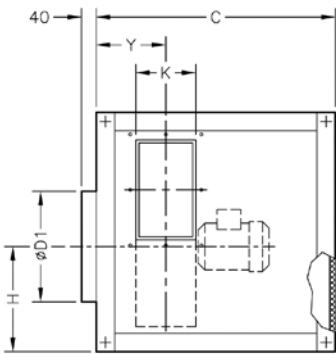

Modelo	A	B	C	ØD1	E	H	H2	K	L	Y
CJTTCR/R-1240	970	970	970	400	312	379	350	315	400	307.5
CJTTCR/R-1445	1070	1070	1070	450	357	408	391	355	450	333.5
CJTTCR/R-1650	1160	1160	1160	500	382	447	419	400	500	355
CJTTCR/R-1856	1260	1260	1050	560	422	495	438	450	560	360
CJTTCR/R-2063	1400	1400	1200	630	472	546	488	500	630	395
CJTTCR/R-2271	1555	1555	1355	710	532	607	532	560	715	430

Modelo	k1	k2	J1	J2	Ø0
CJTTCR/R-1240	177.5	-	-	440	11
CJTTCR/R-1445	202.5	-	-	498	11
CJTTCR/R-1650	225	-	-	550	13
CJTTCR/R-1856	-	500	305	-	13
CJTTCR/R-2063	-	560	345	-	13
CJTTCR/R-2271	312.5	-	-	775	13

Curvas características

Q= Caudal en m³/h, m³/s y cfm.

Pe= Presión estática en mmH₂O, Pa e in wg.

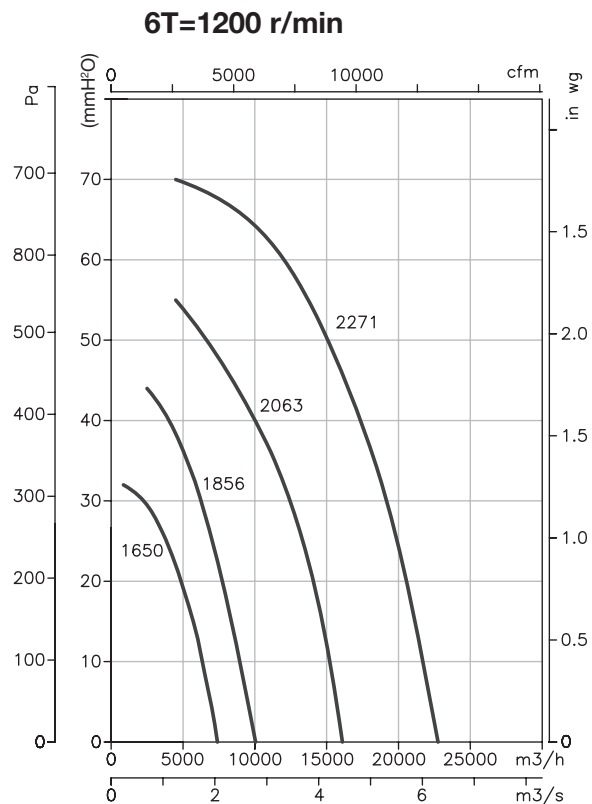
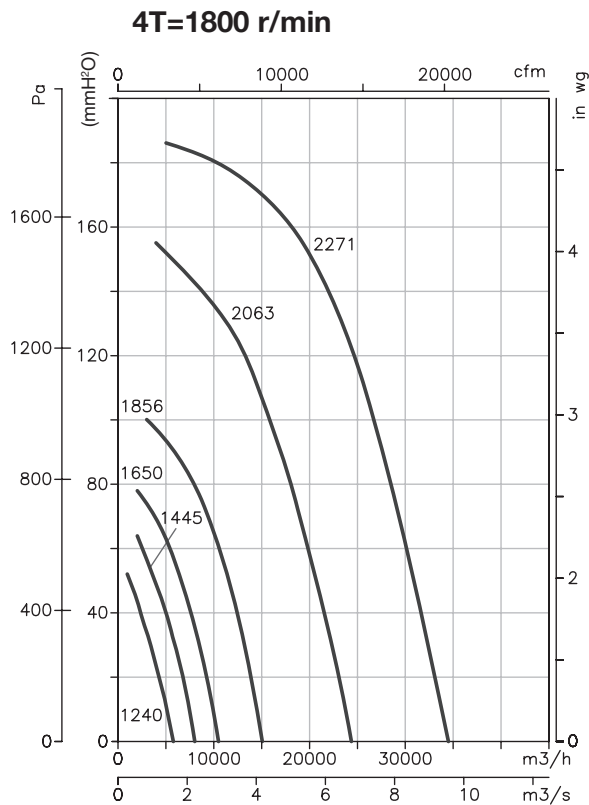
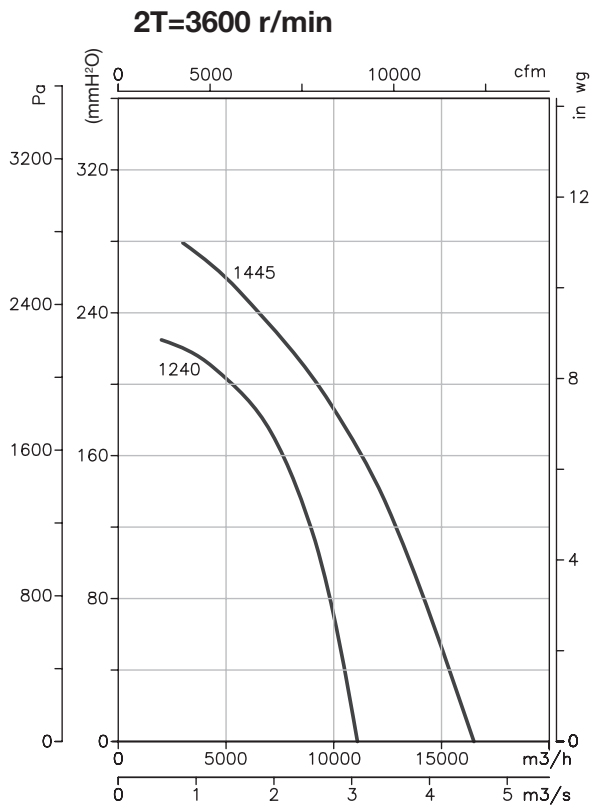

Accesorios



CJTX-C



Unidades de extracción 400°C/2h, a transmisión con ventilador de doble aspiración

Unidades de extracción 400°C/2h, con motor y transmisión en el interior de la caja, para trabajar en el exterior de la zona de riesgo de incendios

Ventilador:

- Estructura en chapa de acero galvanizado
- Turbina con álabes hacia delante, en chapa de acero galvanizado
- Homologación según norma EN 12101-3, con certificación N°: 0370-CPR-0468
- Dirección aire sentido lineal

Motor:

- Motores clase F, con rodamientos a bolas, protección IP55, de 1 ó 2 velocidades según modelo
- Motor Multitensión, diseño especial válido para: 220/380V 60Hz, 254/440V 60Hz, 265/460V 60Hz, 277/480V 60Hz
- Temperatura máxima del aire a transportar: Servicio S1 -20°C+ 120°C en continuo, Servicio S2 300°C/2h y 400°C/2h

Acabado:

- Anticorrosivo en chapa de acero galvanizado

Bajo demanda:

- Extractores con salida vertical



Código de pedido

CJTX-C	—	15/15	—	0,75	—	F-400	—	60Hz
↓		↓		↓		↓		
Unidades de extracción 400°C/2h, a transmisión con ventilador de doble aspiración		Tamaño turbina		Potencia motor (c.v.)		F-400: Homologación 400°C/2h Para Servicio S2: 300°C/2h y 400°C/2h		

Características técnicas

60Hz

Modelo	Velocidad (r/min)	Intensidad máxima admisible (A)		Potencia instalada (kW)	Caudal máximo (m3/h)	Nivel presión sonora dB(A)	Peso aprox. (Kg)
		220-277V	380-480V				
CJTX-C-7/7-0,25	1000	1,03	0,59	0,18	1600	58	53
CJTX-C-7/7-0,33	1200	1,30	0,75	0,25	1825	60	54
CJTX-C-7/7-0,5	1400	1,85	1,06	0,37	2100	64	54
CJTX-C-7/7-0,75	1600	2,59	1,49	0,55	2350	67	58
CJTX-C-7/7-1	1800	2,96	1,71	0,75	2600	69	62
CJTX-C-9/9-0,33	850	1,30	0,75	0,25	2300	58	65
CJTX-C-9/9-0,5	960	1,85	1,06	0,37	2800	61	66
CJTX-C-9/9-0,75	1060	2,59	1,49	0,55	3200	65	69
CJTX-C-9/9-1	1200	2,96	1,71	0,75	3500	67	73
CJTX-C-9/9-1,5	1340	4,38	2,53	1,10	4100	70	80
CJTX-C-9/9-2	1500	5,53	3,19	1,50	4400	72	84
CJTX-C-10/10-0,33	660	1,30	0,75	0,25	2800	57	77
CJTX-C-10/10-0,5	800	1,85	1,06	0,37	3300	61	77
CJTX-C-10/10-0,75	880	2,59	1,49	0,55	3800	63	81
CJTX-C-10/10-1	1000	2,96	1,71	0,75	4200	65	85
CJTX-C-10/10-1,5	1130	4,38	2,53	1,10	4800	68	92

Características técnicas

Modelo	Velocidad (r/min)	Intensidad máxima admisible (A)		Potencia instalada (kW)	Caudal máximo (m ³ /h)	Nivel presión sonora dB(A)	Peso aprox. (Kg)
		220-277V	380-480V				
CJTX-C-10/10-2	1270	5,53	3,19	1,50	5300	71	94
CJTX-C-10/10-3	1450	8,40	4,85	2,20	5900	74	89
CJTX-C-12/12-0,5	600	1,85	1,06	0,37	4200	60	96
CJTX-C-12/12-0,75	700	2,59	1,49	0,55	4600	63	99
CJTX-C-12/12-1	800	2,96	1,71	0,75	5100	65	104
CJTX-C-12/12-1,5	880	4,38	2,53	1,10	5700	68	111
CJTX-C-12/12-2	1020	5,53	3,19	1,50	6400	70	113
CJTX-C-12/12-3	1140	8,40	4,85	2,20	7400	73	107
CJTX-C-12/12-4	1250	11,22	6,48	3,00	8200	75	115
CJTX-C-15/15-0,75	530	2,59	1,49	0,55	4700	59	126
CJTX-C-15/15-1	560	2,96	1,71	0,75	6000	61	130
CJTX-C-15/15-1,5	630	4,38	2,53	1,10	7000	64	138
CJTX-C-15/15-2	700	5,53	3,19	1,50	7800	66	141
CJTX-C-15/15-3	800	8,40	4,85	2,20	9000	69	135
CJTX-C-15/15-4	880	11,22	6,48	3,00	10000	72	144
CJTX-C-15/15-5,5	970	14,98	8,65	4,00	11000	73	145
CJTX-C-18/18-1	460	2,96	1,71	0,75	7500	60	163
CJTX-C-18/18-1,5	510	4,38	2,53	1,10	9000	61	171
CJTX-C-18/18-2	540	5,53	3,19	1,50	10800	64	175
CJTX-C-18/18-3	610	8,40	4,85	2,20	12500	67	170
CJTX-C-18/18-4	680	11,22	6,48	3,00	14000	70	177
CJTX-C-18/18-5,5	750	14,98	8,65	4,00	15000	72	178
CJTX-C-18/18-7,5	850		11,40	5,50	16500	74	188
CJTX-C-18/18-10	930		14,80	7,50	18000	77	202
CJTX-C-20/20-2	450	5,53	3,19	1,50	13000	64	276
CJTX-C-20/20-3	530	8,40	4,85	2,20	15000	68	270
CJTX-C-20/20-4	580	11,22	6,48	3,00	16300	70	277
CJTX-C-20/20-5,5	660	14,98	8,65	4,00	18000	72	279
CJTX-C-20/20-7,5	740		11,40	5,50	20500	74	289
CJTX-C-20/20-10	815		14,80	7,50	22500	77	304
CJTX-C-22/22-2	380	5,53	3,19	1,50	14000	62	318
CJTX-C-22/22-3	430	8,40	4,85	2,20	16000	64	312
CJTX-C-22/22-4	480	11,22	6,48	3,00	18000	68	320
CJTX-C-22/22-5,5	520	14,98	8,65	4,00	20000	69	323
CJTX-C-22/22-7,5	580		11,40	5,50	22500	72	333
CJTX-C-22/22-10	650		14,80	7,50	25000	74	346
CJTX-C-22/22-15	740		21,00	11,00	28000	77	358
CJTX-C-22/22-20	780		28,60	15,00	31000	79	424
CJTX-C-25/25-3	340	8,40	4,85	2,20	20000	66	369
CJTX-C-25/25-4	380	11,22	6,48	3,00	22000	68	376
CJTX-C-25/25-5,5	420	14,98	8,65	4,00	24000	70	377
CJTX-C-25/25-7,5	470		11,40	5,50	26500	73	393
CJTX-C-25/25-10	510		14,80	7,50	29000	75	401
CJTX-C-25/25-15	570		21,00	11,00	34000	78	419
CJTX-C-25/25-20	630		28,60	15,00	38000	80	482
CJTX-C-30/28-3	250	8,40	4,85	2,20	25000	64	502
CJTX-C-30/28-4	280	11,22	6,48	3,00	27000	66	516
CJTX-C-30/28-5,5	340	14,98	8,65	4,00	29000	68	517
CJTX-C-30/28-7,5	360		11,40	5,50	32500	71	530
CJTX-C-30/28-10	410		14,80	7,50	36000	73	545
CJTX-C-30/28-15	480		21,00	11,00	40000	76	557
CJTX-C-30/28-20	520		28,60	15,00	45000	78	627
CJTX-C-30/28-25	550		36,00	18,50	49000	79	609

Dimensiones mm

Suministro standard impulsión horizontal (H): LG-90

VISTA EN PLANTA

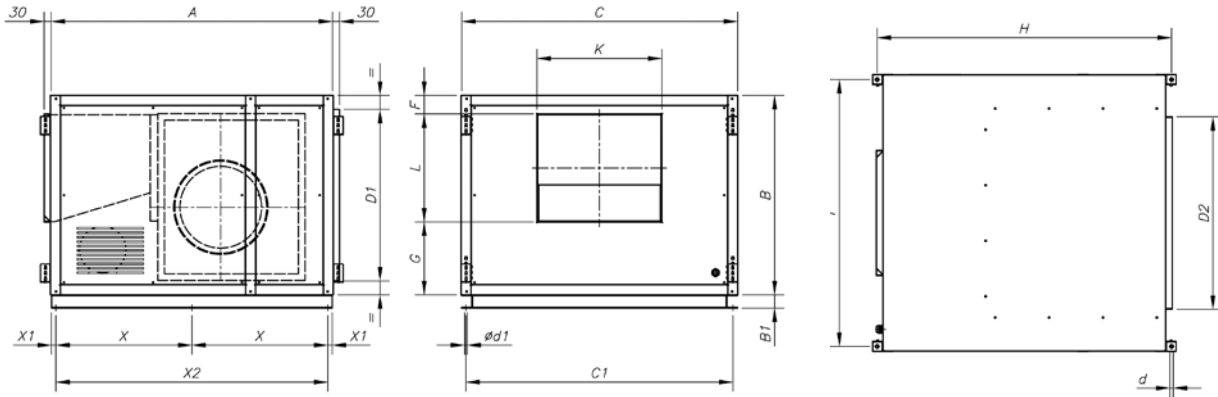

	A	B	B1	C	C1	ød	ød1	D1	D2	F	G	H	I	K	L	X	X1	X2
CJTX-C-7/7	700	480	-	730	695	10,5	9	354	470	62	202	750	685	239	216	-	-	-
CJTX-C-9/9	785	592	-	759	716	10,5	9	466	490	92	230	835	714	305	270	-	-	-
CJTX-C-10/10	860	618	-	825	782	10,5	9	492	520	87	235	910	780	334	296	-	-	-
CJTX-C-12/12	970	680	-	945	902	10,5	9	554	620	80	250	1020	900	395	350	-	-	-
CJTX-C-15/15	1100	776	-	1100	1057	10,5	9	650	720	80	285	1150	1055	483	411	-	-	-
CJTX-C-18/18	1278	900	60	1250	1207	10,5	11	774	870	95	325	1328	1205	552	480	614,5	20	1229
CJTX-C-20/20	1495	1050	60	1474	1431	13	11	954	1100	122	347	1555	1419	611	611	722,5	20	1545
CJTX-C-22/22	1640	1180	60	1625	1582	13	11	1054	1250	125	350	1700	1570	665	705	795,5	20	1591
CJTX-C-25/25	1800	1300	60	1825	1782	13	11	1174	1450	125	369	1860	1770	775	806	875,5	20	1751
CJTX-C-30/28	2000	1525	60	2134	2091	13	11	1399	1760	118	465	2060	2079	900	942	975,5	20	1951

Suministro bajo demanda: Impulsión vertical (V) LG-0

VISTA EN PLANTA

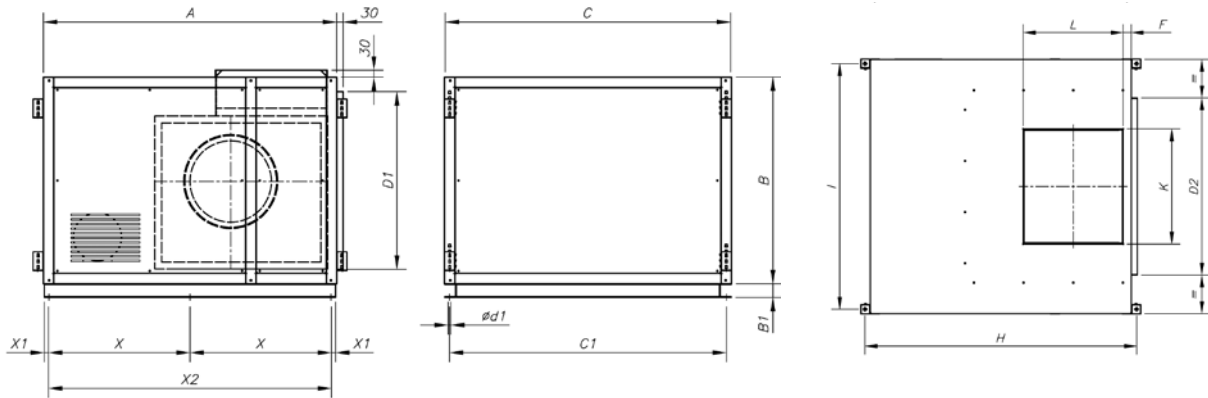

	A	B	B1	C	C1	ød	ød1	D1	D2	F	H	I	K	L	X	X1	X2
CJTX-C-7/7	700	480	-	730	695	10,5	9	354	470	165	750	685	238	210	-	-	-
CJTX-C-9/9	785	592	-	759	716	10,5	9	466	490	157	835	714	312	272	-	-	-
CJTX-C-10/10	860	618	-	825	782	10,5	9	492	520	135	910	780	333	300	-	-	-
CJTX-C-12/12	970	680	-	945	902	10,5	9	554	620	183	1020	900	397	355	-	-	-
CJTX-C-15/15	1100	776	-	1100	1057	10,5	9	650	720	197	1150	1055	479	421	-	-	-
CJTX-C-18/18	1278	900	60	1250	1207	10,5	11	774	870	281	1328	1205	550	495	614,5	20	1229
CJTX-C-20/20	1495	1050	60	1474	1431	13	11	954	1100	283	1555	1419	610	611	722,5	20	1545
CJTX-C-22/22	1640	1180	60	1625	1582	13	11	1054	1250	325	1700	1570	666	701	795,5	20	1591
CJTX-C-25/25	1800	1300	60	1825	1782	13	11	1174	1450	367	1860	1770	775	798	875,5	20	1751
CJTX-C-30/28	2000	1525	60	2134	2091	13	11	1399	1760	407	2060	2079	894	947	975,5	20	1951

Curvas características

Q= Caudal en m³/h, m³/s y cfm.

Pe= Presión estática en mmH₂O, Pa e inwg.

CJTX-C-7/7

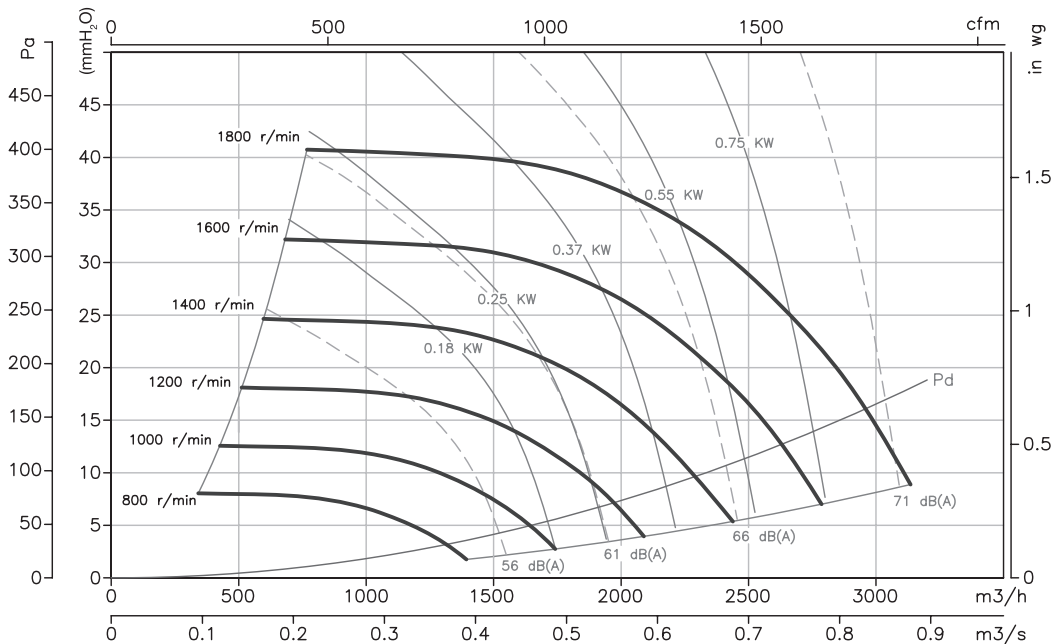

CJTX-C-9/9

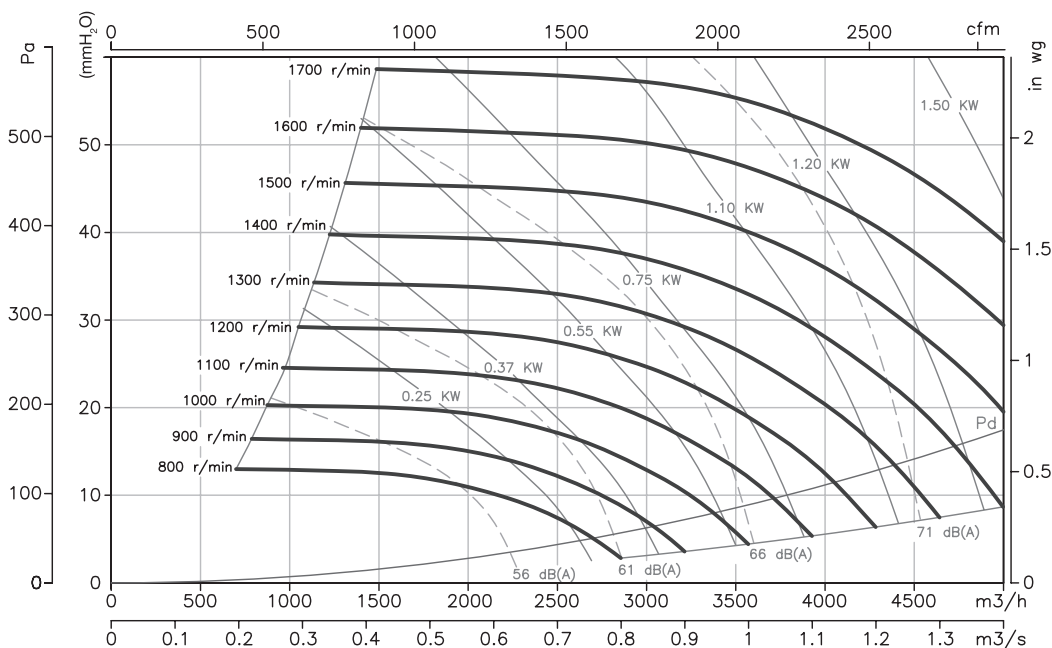

Curvas características

Q= Caudal en m³/h, m³/s y cfm.

Pe= Presión estática en mmH₂O, Pa e inwg.

CJTX-C-10/10

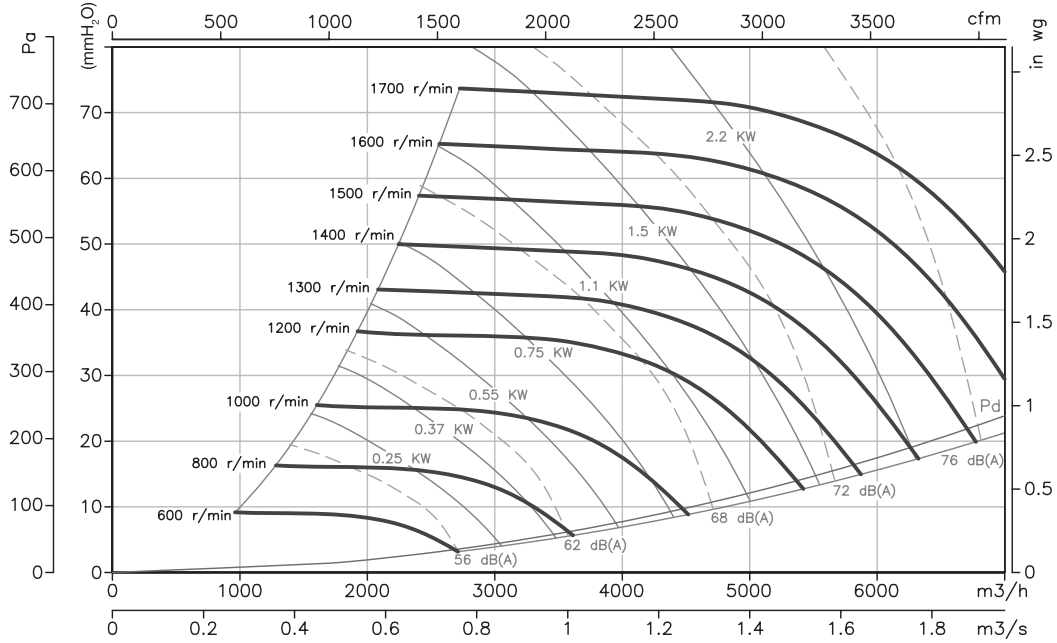

CJTX-C-12/12

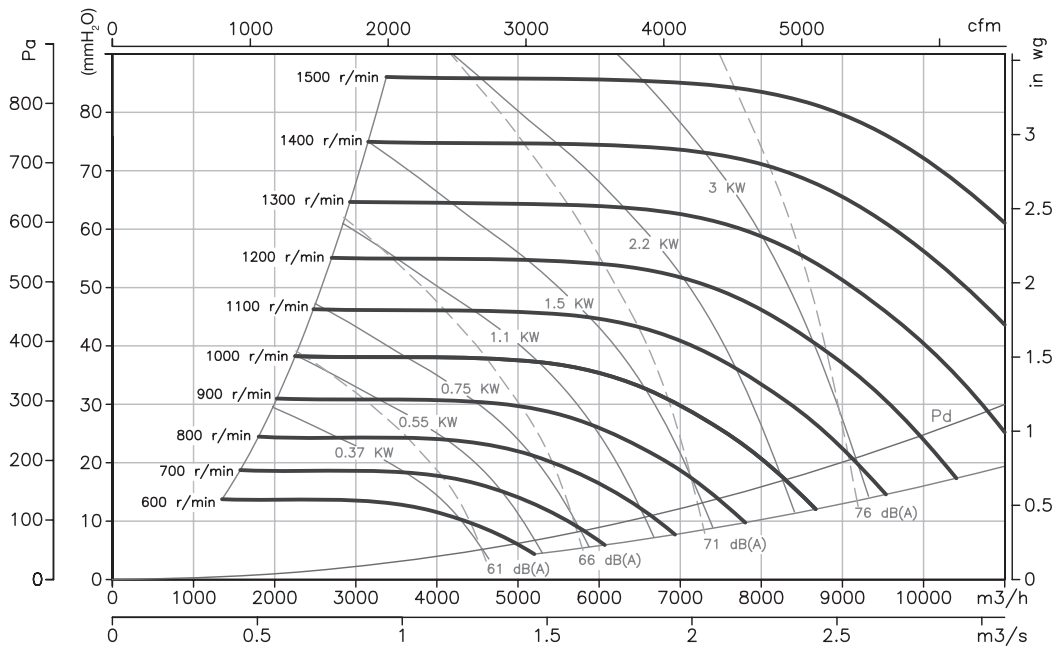

Curvas características

Q= Caudal en m³/h, m³/s y cfm.

Pe= Presión estática en mmH₂O, Pa e inwg.

CJTX-C-15/15

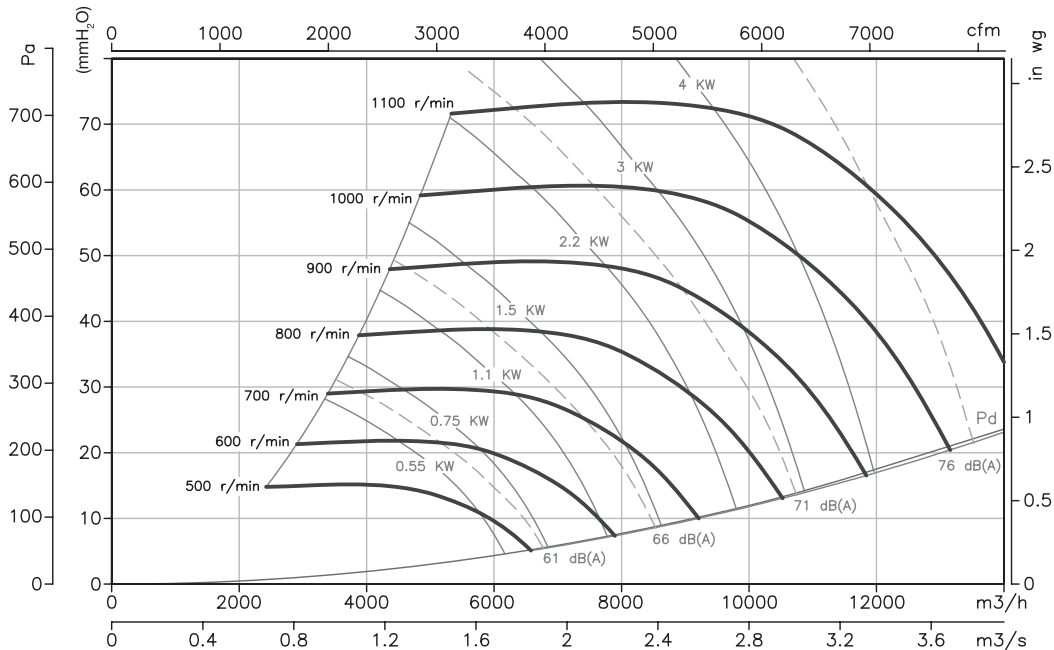

CJTX-C-18/18

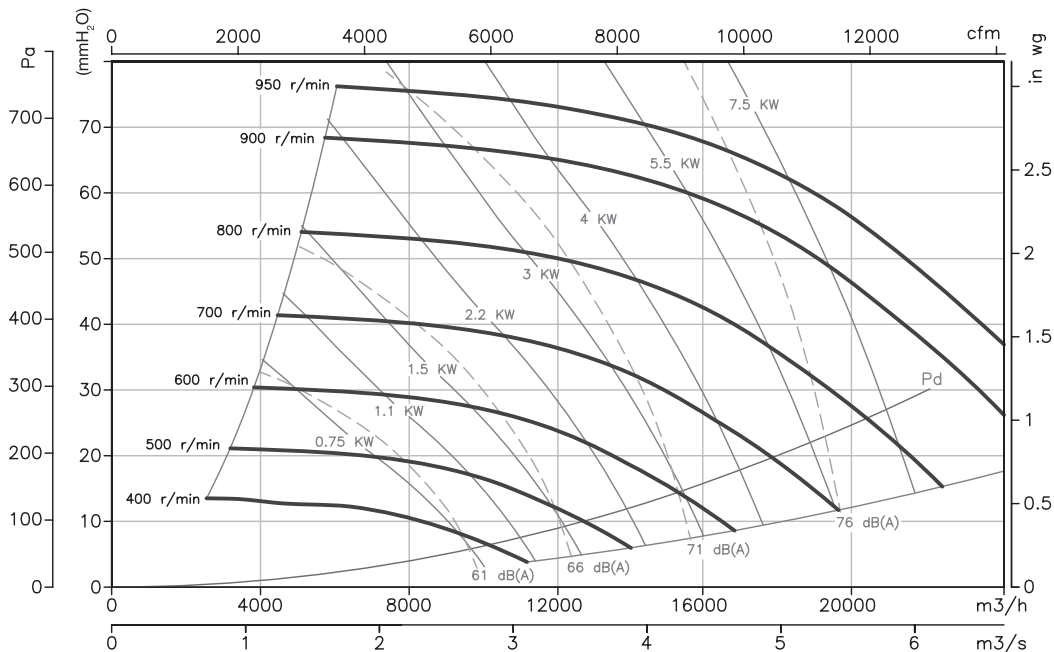

Curvas características

Q= Caudal en m³/h, m³/s y cfm.

Pe= Presión estática en mmH₂O, Pa e inwg.

CJTX-C-20/20

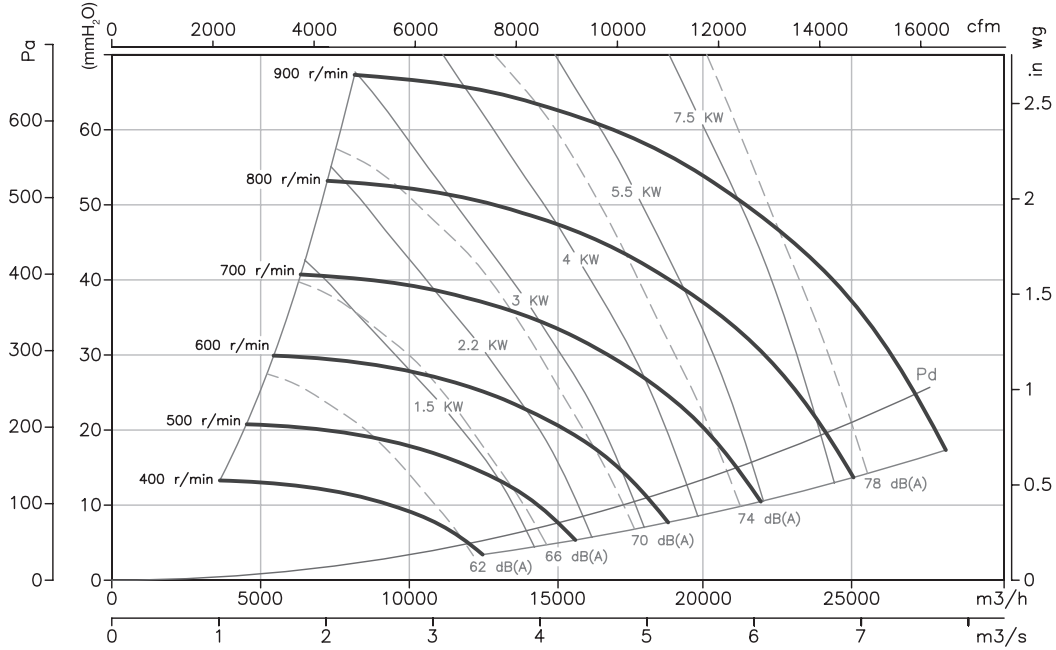

CJTX-C-22/22

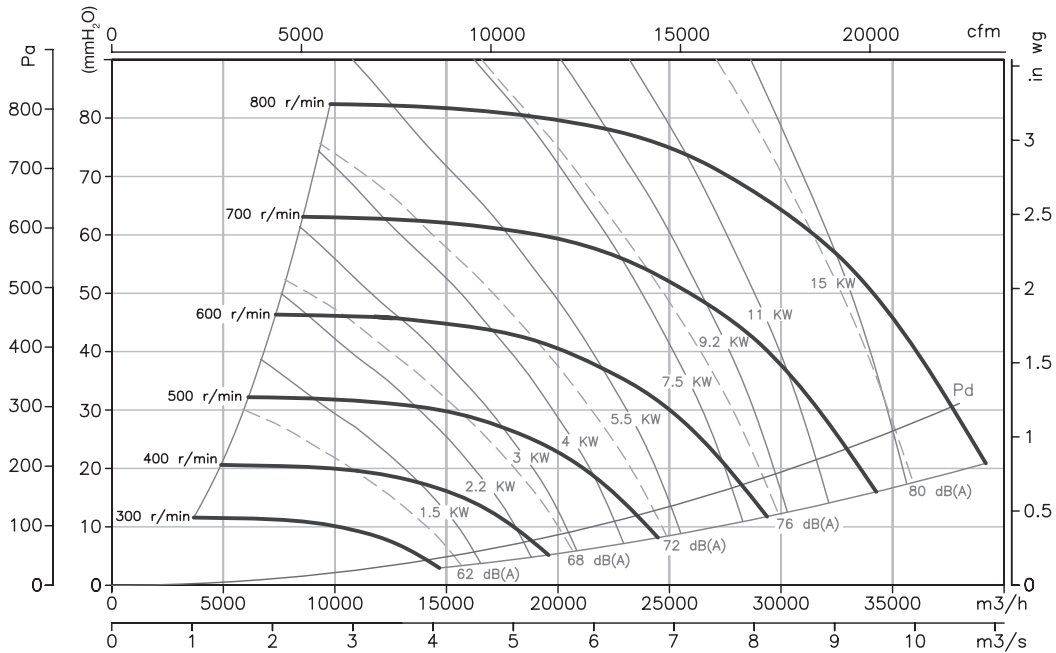

Curvas características

Q= Caudal en m³/h, m³/s y cfm.

Pe= Presión estática en mmH₂O, Pa e inwg.

CJTX-C-25/25

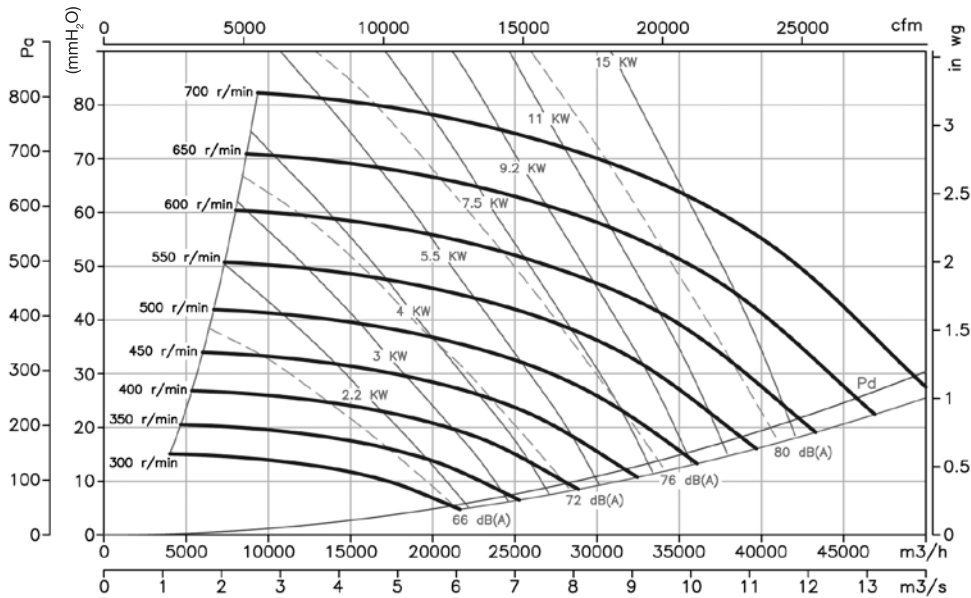

CJTX-C-30/28

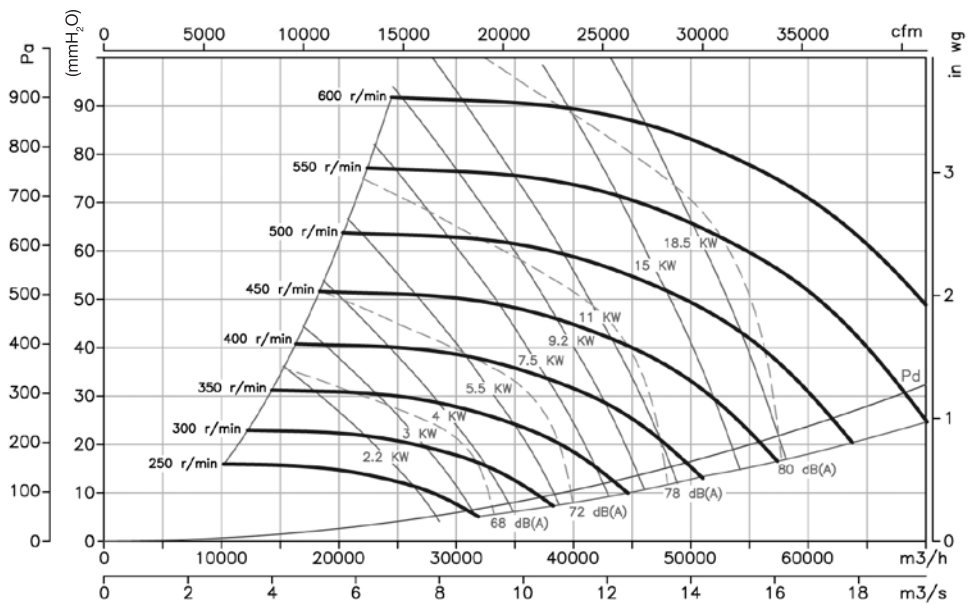

Accesorios



CJSX



Motor fuera del paso del aire

Unidades de extracción 400°C/2h, a transmisión con ventilador de simple aspiración

Unidades de extracción 400°C/2h, con motor fuera del paso del aire, para trabajar en el exterior de la zona de riesgo de incendios

Ventilador:

- Estructura en chapa de acero galvanizado
- Turbina con álabes hacia delante, en chapa de acero galvanizado
- Homologación según norma EN 12101-3, con certificación N°: 0370-CPR-0503

Motor:

- Motores clase F, con rodamientos a bolas, protección IP55
- Motor Multitensión, diseño especial válido para: 220/380V 60Hz, 254/440V 60Hz, 265/460V 60Hz, 277/480V 60Hz
- Temperatura máxima del aire a transportar: Servicio S1 -20°C+ 120°C en continuo, Servicio S2 300°C/2h y 400°C/2h

Acabado:

- Anticorrosivo en chapa de acero galvanizado

Bajo demanda:

- Extractores con motor de 2 velocidades
- Extractores con salida vertical



Código de pedido

CJSX	—	22/11	—	3	—	F-400	—	60Hz
↓		↓		↓		↓		
Extractores centrífugos 400°C/2h, con turbina a reacción		Tamaño turbina		Potencia motor (c.v.)		F-400: Homologación 400°C/2h		
						Para Servicio S2: 300°C/2h y 400°C/2h		

Características técnicas

60Hz

Modelo	Velocidad (r/min)	Intensidad máxima admisible (A)		Potencia instalada (kW)	Caudal máximo (m3/h)	Nivel presión sonora dB(A)	Peso aprox. (Kg)
		220-277V	380-480V				
CJSX-12/6-0,75	1000	2,42	1,40	0,55	2600	69	73
CJSX-12/6-1	1100	3,29	1,90	0,75	3100	71	74
CJSX-12/6-1,5	1250	4,49	2,59	1,10	3500	74	77
CJSX-12/6-2	1300	5,98	3,45	1,50	4250	77	80
CJSX-12/6-3	1500	8,31	4,80	2,20	4800	79	85
CJSX-15/7-1	800	3,29	1,90	0,75	4000	67	92
CJSX-15/7-1,5	850	4,49	2,59	1,10	4800	69	95
CJSX-15/7-2	920	5,98	3,45	1,50	5400	72	98
CJSX-15/7-3	1000	8,31	4,80	2,20	6400	75	103
CJSX-15/7-4	1050	11,22	6,48	3,00	7400	77	106
CJSX-18/9-1,5	750	4,49	2,59	1,10	5800	68	111
CJSX-18/9-2	790	5,98	3,45	1,50	6600	70	114
CJSX-18/9-3	800	8,31	4,80	2,20	8200	74	119
CJSX-18/9-4	850	11,22	6,48	3,00	9000	76	122
CJSX-18/9-5,5	920	14,90	8,60	4,00	10500	78	125
CJSX-20/10-2	650	5,98	3,45	1,50	8100	65	203
CJSX-20/10-3	690	8,31	4,80	2,20	10100	68	208
CJSX-20/10-4	750	11,22	6,48	3,00	11500	70	211
CJSX-20/10-5,5	790	14,90	8,60	4,00	13100	73	214
CJSX-20/10-7,5	850		11,10	5,50	15000	75	227
CJSX-22/11-3	580	8,31	4,80	2,20	11200	67	219
CJSX-22/11-4	610	11,22	6,48	3,00	13000	70	222
CJSX-22/11-5,5	650	14,90	8,60	4,00	15000	72	225
CJSX-22/11-7,5	690		11,10	5,50	17000	74	238

Características técnicas

Modelo	Velocidad (r/min)	Intensidad máxima admisible (A)		Potencia instalada (kW)	Caudal máximo (m3/h)	Nivel presión sonora dB(A)	Peso aprox. (Kg)
		220-277V	380-480V				
CJSX-22/11-10	750		14,80	7,50	19000	76	246
CJSX-22/11-12,5	790		17,80	9,20	21000	78	257
CJSX-22/11-15	830		21,50	11,00	22000	79	273
CJSX-22/11-20	910		28,50	15,00	24500	81	292
CJSX-22/11-25	1000		35,00	18,50	26000	83	322
CJSX-25/13-4	520	11,22	6,48	3,00	14000	62	254
CJSX-25/13-5,5	550	14,90	8,60	4,00	17000	65	257
CJSX-25/13-7,5	590		11,10	5,50	19500	67	270
CJSX-25/13-10	620		14,80	7,50	23000	70	278
CJSX-25/13-12,5	650		17,80	9,20	25000	72	289
CJSX-25/13-15	690		21,50	11,00	26500	74	305
CJSX-25/13-20	750		28,50	15,00	29500	75	324
CJSX-25/13-25	810		35,00	18,50	32000	77	354
CJSX-30/14-5,5	400	14,90	8,60	4,00	21000	69	331
CJSX-30/14-7,5	425		11,10	5,50	24000	72	344
CJSX-30/14-10	460		14,80	7,50	27500	74	352
CJSX-30/14-12,5	480		17,80	9,20	30000	76	363
CJSX-30/14-15	500		21,50	11,00	33000	77	379
CJSX-30/14-20	550		28,50	15,00	36500	78	398
CJSX-30/14-25	600		35,00	18,50	38000	81	428

Dimensiones mm

Suministro standard impulsión horizontal (H) RD-90

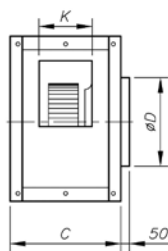
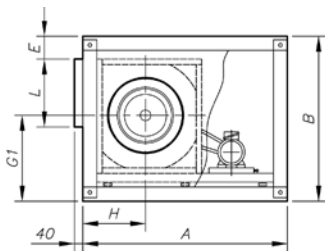

Bajo demanda impulsión vertical (V) RD-0

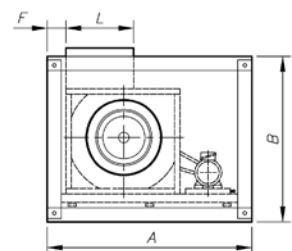
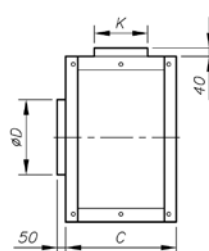

Bajo demanda impulsión horizontal (H) LG-90

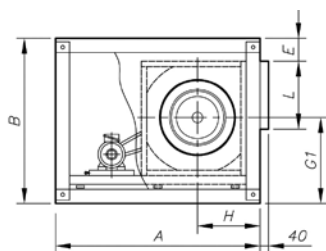
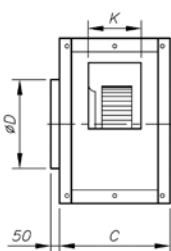

Bajo demanda impulsión vertical (V) LG-0

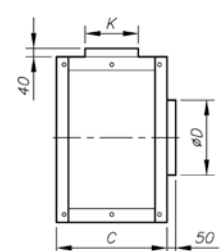
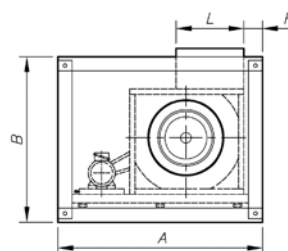

Modelo	A	B	C	ØD	E	con bancada		con bancada		con bancada			
						E	F	G1	G1	H	L	L	K
CJSX-12/6-H	850	650	540	330	74	-	-	288	-	288	346	-	210
CJSX-12/6-V	850	650	540	330	-	-	30	318	-	328	346	-	210
CJSX-15/7-H	1000	755	600	400	74	-	-	328	-	328	411	-	270
CJSX-15/7-V	1000	755	600	400	-	-	30	378	-	383	411	-	270
CJSX-18/9-H	1200	875	620	480	74	-	-	383	-	388	491	-	305
CJSX-18/9-V	1200	875	620	480	-	-	30	433	-	448	491	-	305
CJSX-20/10-H	1485	1175	730	565	175	120	-	475	530	440	613	605	343
CJSX-20/10-V	1485	1175	730	565	-	-	75	535	-	585	613	-	343
CJSX-22/11-H	1570	1250	760	615	165	110	-	510	565	470	708	700	373
CJSX-22/11-V	1570	1250	760	615	-	-	75	570	-	640	708	-	373
CJSX-25/13-H	1610	1375	820	685	175	120	-	550	605	495	803	795	423
CJSX-25/13-V	1610	1375	820	685	-	-	75	625	-	705	803	-	423
CJSX-30/14-H	1845	1600	855	820	160	95	-	655	710	580	943	935	488
CJSX-30/14-V	1845	1600	855	820	-	-	75	760	-	825	943	-	488

Curvas características

Q= Caudal en m³/h, m³/s y cfm.

Pe= Presión estática en mmH₂O, Pa e inwg.

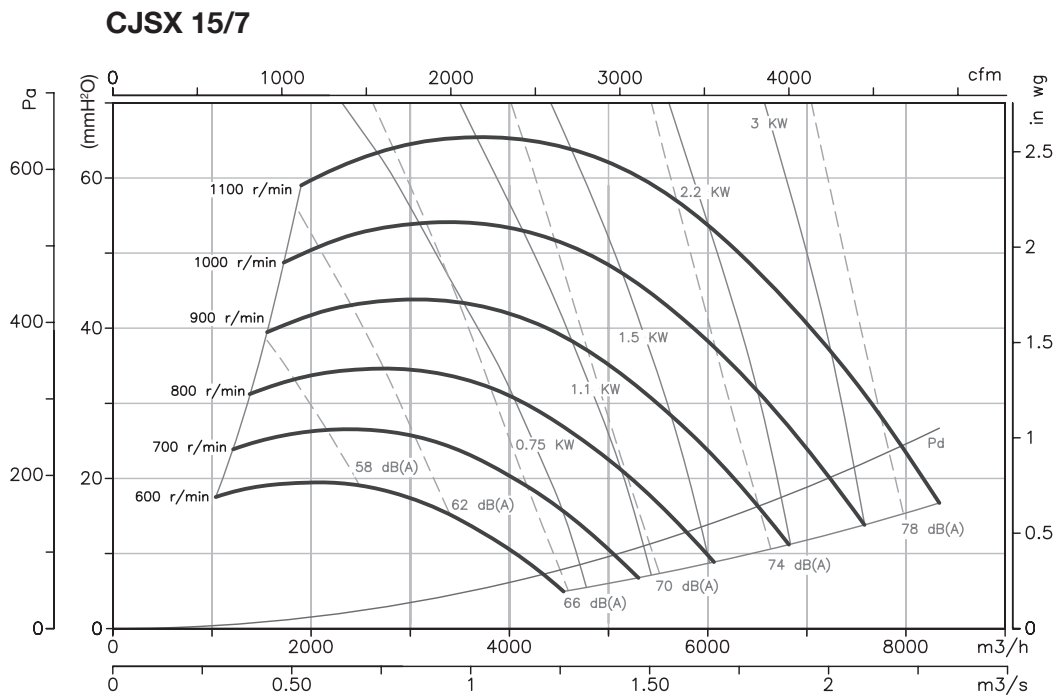
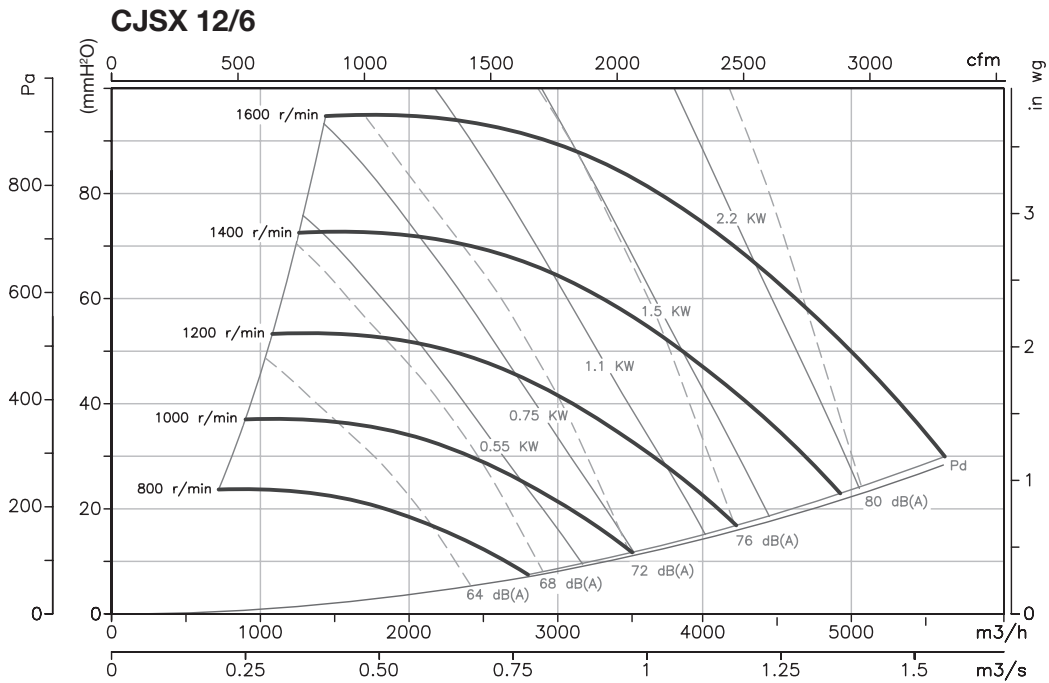

Curvas características

Q= Caudal en m³/h, m³/s y cfm.

Pe= Presión estática en mmH₂O, Pa e inwg.

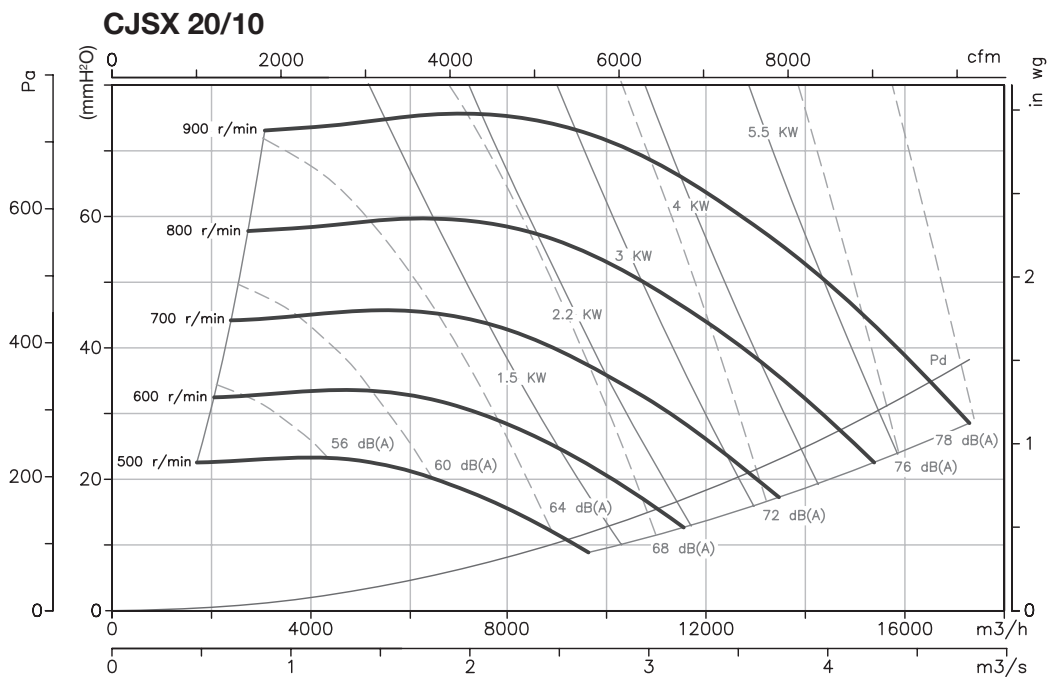
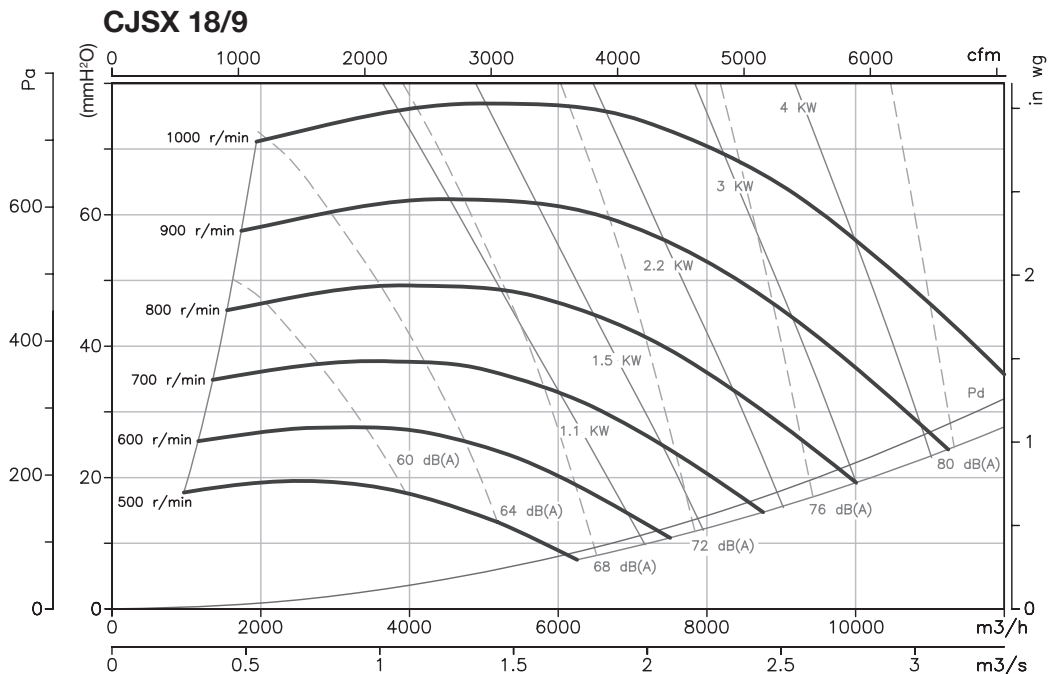

Curvas características

Q= Caudal en m³/h, m³/s y cfm.

Pe= Presión estática en mmH₂O, Pa e inwg.

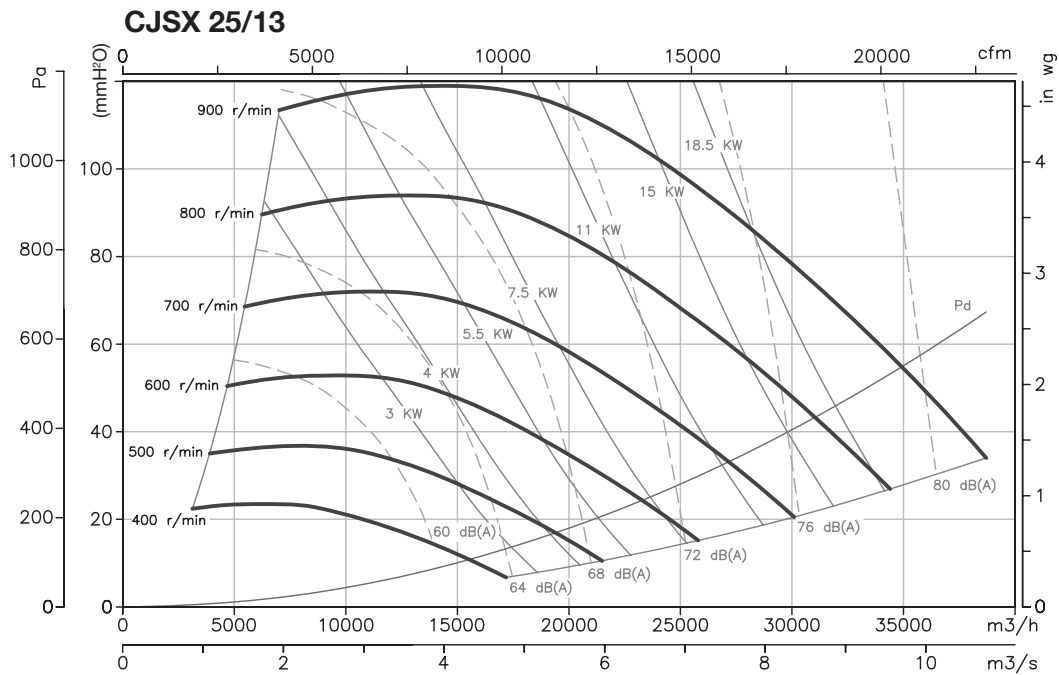
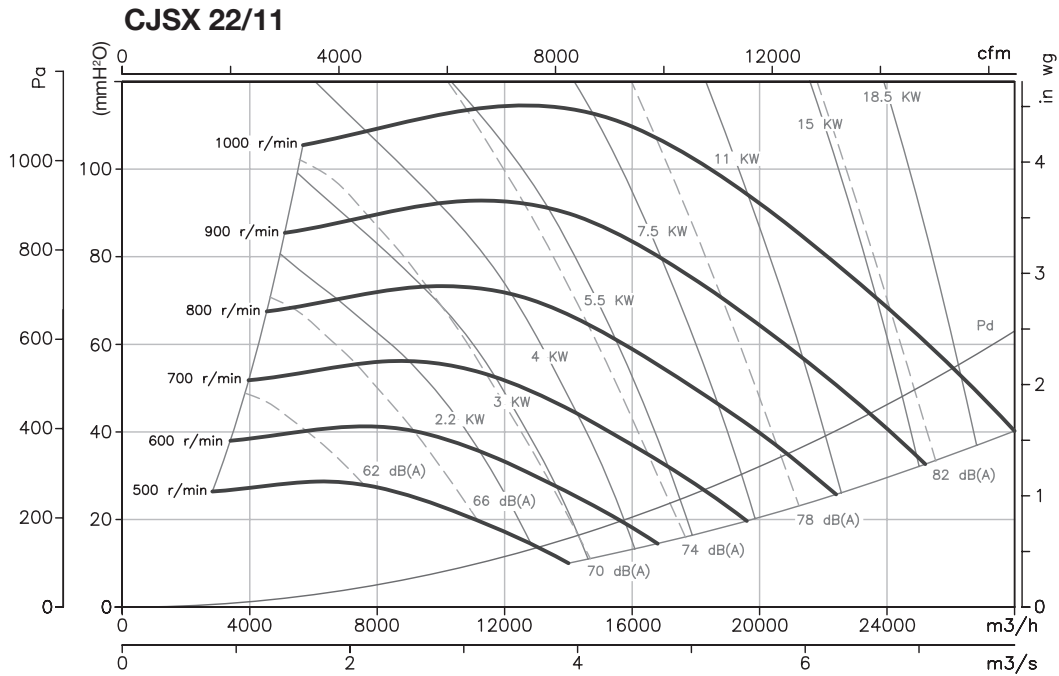

Curvas características

Q= Caudal en m³/h, m³/s y cfm.

Pe= Presión estática en mmH₂O, Pa e inwg.

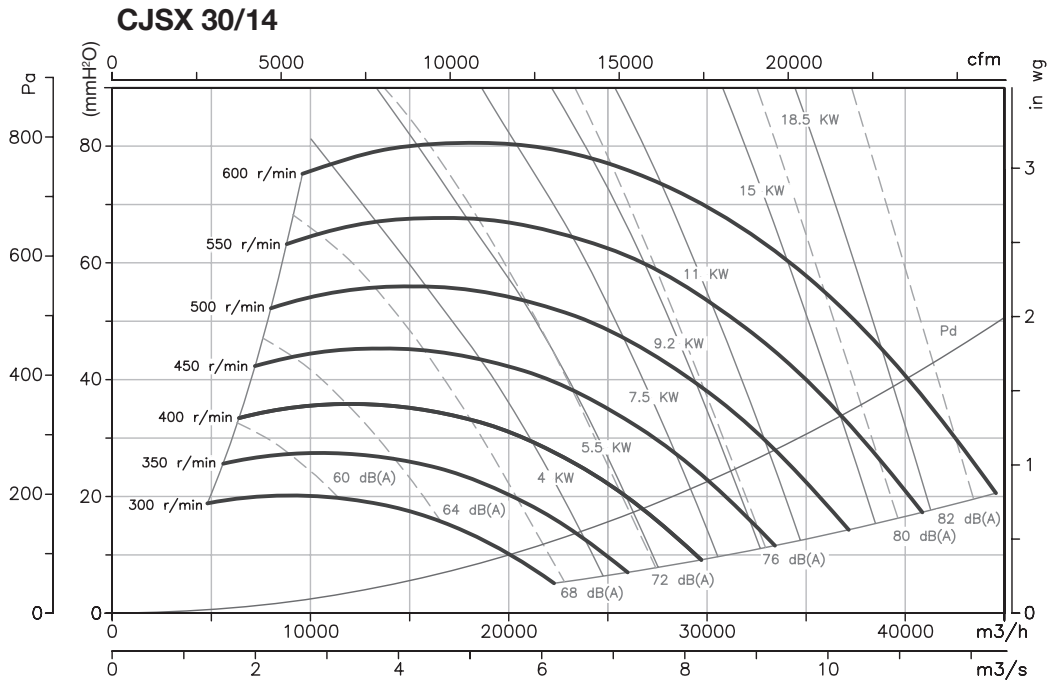

Accesorios

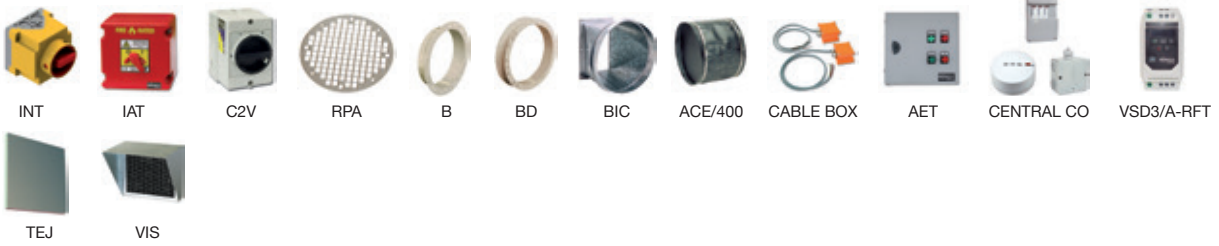

CSX

Extractores centrifugos 400 °C/2h para trabajar en el exterior de la zona de riesgo de incendios, accionados a transmisión con turbina a reacción



Turbina a reacción de alto rendimiento, y gran robustez

Extractores centrifugos 400 °C/2h accionados a transmisión con turbina a reacción equipados con motor eléctrico, conjunto de poleas, correas y protectores normalizados según norma ISO-13857

Ventilador:

- Envoltente en chapa de acero
- Turbina con álabes a reacción en chapa de acero
- Homologación según norma EN 12101-3:2002/AC:2006 con certificación número 0370-CPR-1577
- Conjunto de poleas, correas y protectores normalizados según norma ISO-13857

Motor:

- Motores de eficiencia IE3 para potencias iguales o superiores a 0,75kW, excepto monofásicos, 2 velocidades y 8 polos.
- Motores clase F, con rodamientos a bolas, protección IP55
- Motor Multitensión, diseño especial válido para: 220/380V 60Hz, 254/440V 60Hz, 265/460V 60Hz, 277/480V 60Hz
- Temperatura máxima del aire a transportar: -20°C + 150°C

Acabado:

- Anticorrosivo en resina de poliéster polimerizada a 190 °C, previo desengrase con tratamiento nanotecnológico libre de fosfatos.

Bajo demanda:

- Bobinados especiales para diferentes tensiones



Código de pedido

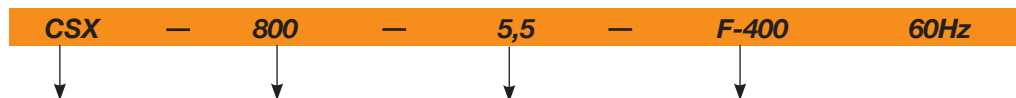

CSX: Extractores centrifugos 400 °C/2h para trabajar en el exterior de la zona de riesgo de incendios, accionados a transmisión

Tamaño turbina

Potencia motor (c.v.)

F-400: Homologación 400°C/2h

Características técnicas



Modelo	Velocidad (r/min)	Intensidad máxima admisible (A)		Potencia instalada (kW)	Caudal máximo (m3/h)	Peso aprox. (Kg)
		220-277V	380-480V			
CSX-315-0,5	1650	1,84	1,06	0,37	2700	56
CSX-315-0,75	1880	2,35	1,35	0,55	3075	58
CSX-315-1	2095	3,13	1,80	0,75	3430	57
CSX-315-1,5	2375	4,35	2,50	1,10	3885	62
CSX-315-2	2655	5,83	3,35	1,50	4345	63
CSX-315-3	3000	7,60	4,37	2,20	4910	75
CSX-315-4	3380	10,35	5,95	3,00	5530	77
CSX-355-0,5	1385	1,84	1,06	0,37	3235	64
CSX-355-0,75	1580	2,43	1,40	0,55	3685	65
CSX-355-1	1765	3,13	1,80	0,75	4120	65
CSX-355-1,5	2010	4,35	2,50	1,10	4690	70
CSX-355-2	2225	5,83	3,35	1,50	5190	71
CSX-355-3	2530	7,60	4,37	2,20	5905	82
CSX-355-4	2860	10,35	5,95	3,00	6675	84
CSX-355-5,5	3100	13,22	7,60	4,00	7235	94
CSX-400-0,75	1320	2,35	1,35	0,55	4375	81
CSX-400-1	1465	3,30	1,90	0,75	4855	84
CSX-400-1,5	1665	4,50	2,59	1,10	5515	86
CSX-400-2	1845	5,83	3,35	1,50	6110	93
CSX-400-3	2100	7,60	4,37	2,20	6955	101

Características técnicas

Modelo	Velocidad (r/min)	Intensidad máxima admisible (A)		Potencia instalada (kW)	Caudal máximo (m ³ /h)	Peso aprox. (Kg)
		220-277V	380-480V			
CSX-400-4	2370	10,35	5,95	3,00	7850	99
CSX-400-5,5	2610	13,22	7,60	4,00	8645	109
CSX-450-0,75	1095	2,43	1,40	0,55	5045	101
CSX-450-1	1220	3,30	1,90	0,75	5620	106
CSX-450-1,5	1390	4,50	2,59	1,10	6405	106
CSX-450-2	1540	6,00	3,45	1,50	7095	113
CSX-450-3	1750	8,35	4,80	2,20	8065	121
CSX-450-4	1980	10,35	5,95	3,00	9120	119
CSX-450-5,5	2180	13,22	7,60	4,00	10045	129
CSX-450-7,5	2420	-	10,50	5,50	11150	151
CSX-450-10	2670	-	13,90	7,50	12300	154
CSX-500-1	1005	3,30	1,90	0,75	6465	132
CSX-500-1,5	1140	4,50	2,59	1,10	7330	132
CSX-500-2	1270	6,00	3,45	1,50	8165	138
CSX-500-3	1445	8,35	4,80	2,20	9290	147
CSX-500-4	1635	11,27	6,48	3,00	10510	149
CSX-500-5,5	1800	13,91	8,00	4,00	11570	158
CSX-500-7,5	2000	-	11,10	5,50	12855	176
CSX-500-10	2220	-	13,90	7,50	14270	179
CSX-500-15	2300	-	20,50	11,00	14785	204
CSX-560-2	1035	6,00	3,45	1,50	9885	189
CSX-560-3	1185	8,35	4,80	2,20	11360	191
CSX-560-4	1340	11,27	6,48	3,00	12880	194
CSX-560-5,5	1475	13,91	8,00	4,00	14210	203
CSX-560-7,5	1640	-	11,10	5,50	15830	221
CSX-560-10	1815	-	14,80	7,50	17555	224
CSX-560-15	2065	-	20,50	11,00	20010	249
CSX-630-3	1010	8,35	4,80	2,20	12120	216
CSX-630-4	1140	11,27	6,48	3,00	13680	218
CSX-630-5,5	1255	13,91	8,00	4,00	15060	227
CSX-630-7,5	1395	-	11,10	5,50	16740	245
CSX-630-10	1550	-	14,80	7,50	18600	248
CSX-630-15	1760	-	22,00	11,00	21120	273
CSX-630-20	1900	-	29,00	15	22800	303
CSX-710-4	960	11,27	6,48	3,00	17065	260
CSX-710-5,5	1060	13,91	8,00	4,00	18845	269
CSX-710-7,5	1180	-	11,10	5,50	20980	287
CSX-710-10	1305	-	14,80	7,50	23200	289
CSX-710-15	1485	-	22,00	11,00	26400	315
CSX-710-20	1670	-	29,00	15,00	29690	345
CSX-710-25	1750	-	36,50	18,50	31110	363
CSX-800-4	765	11,27	6,48	3,00	19975	306
CSX-800-5,5	845	13,91	8,00	4,00	22065	315
CSX-800-7,5	940	-	11,10	5,50	24545	333
CSX-800-10	1040	-	14,80	7,50	27155	336
CSX-800-15	1185	-	22,00	11,00	30940	361
CSX-800-20	1330	-	29,00	15,00	34730	391
CSX-800-25	1420	-	36,50	18,50	37080	409
CSX-900-4	640	11,27	6,48	3,00	21200	385
CSX-900-5,5	705	13,91	8,00	4,00	23355	394
CSX-900-7,5	785	-	11,10	5,50	26005	412
CSX-900-10	870	-	14,80	7,50	28820	415
CSX-900-15	990	-	22,00	11,00	32795	440
CSX-900-20	1100	-	29,00	15,00	36440	470
CSX-900-25	1150	-	36,50	18,50	38095	488
CSX-900-30	1200	-	42,00	22,00	39750	522
CSX-1000-5,5	575	13,91	8,00	4,00	25555	487
CSX-1000-7,5	645	-	11,10	5,50	28665	479
CSX-1000-10	715	-	14,80	7,50	31780	482
CSX-1000-15	815	-	22,00	11,00	36220	507
CSX-1000-20	915	-	29,00	15,00	40665	537
CSX-1000-25	980	-	36,50	18,50	43555	555
CSX-1000-30	1040	-	42,00	22,00	46220	589
CSX-1000-40	1120	-	59,00	30,00	49780	619

Dimensiones mm

Suministro standard RD-90

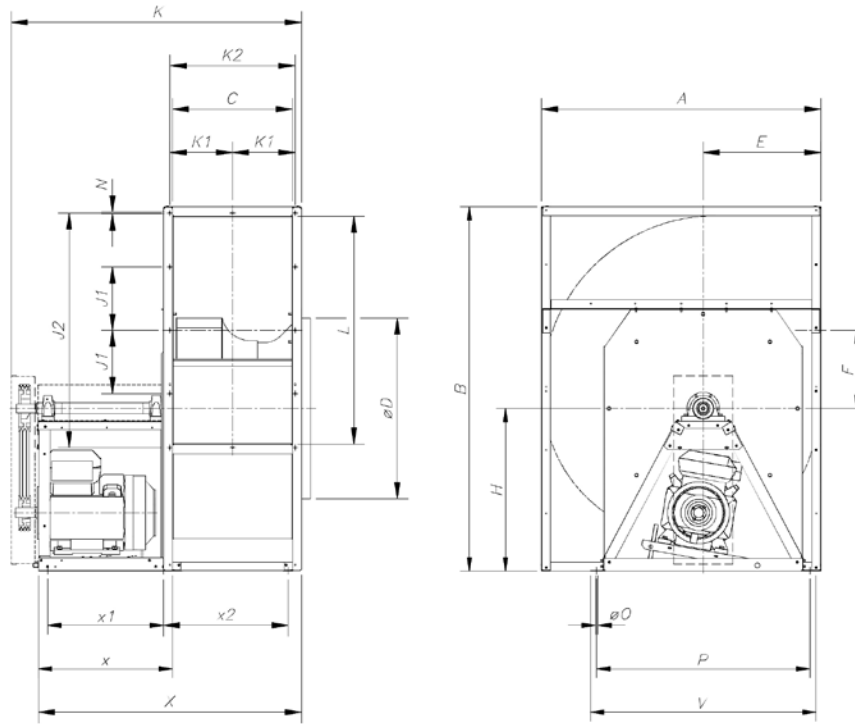

	A	B	C	L	K2	K1	J2	J1	N	øD	H	E	F	K	X	øD	P	V	x1	x2	x
CSX-315	522	771,5	223	404	253	126,5	434	-	13x9	313	400	236	139,5	769	679	12	454	504	315	264	415
CSX-355	582,5	869,5	247	453	277	138,5	483	-	13x9	353	450	261	158	793	703	12	496	546	315	288	415
CSX-400	651	963	274	507	304	152	537	-	13x9	398	500	290	179,5	820	730	12	542	592	315	315	415
CSX-450	727,5	1067	308	569	338	169	599	-	13x9	448	550	322	202,5	959	829	12	595	645	380	349	480
CSX-500	801	1180	344	638	374	187	658	-	13x9	498	600	352	221	1005	875	12	654	704	380	380	480
CSX-560	892,5	1295	383	715	413	206,5	745	-	13x9	558	650	390	247,5	1202	1064	12	715	765	515	424	630
CSX-630	998,5	1489,5	432	801	462	231	831	-	13x9	628	769	434	280	1251	1113	12	780	830	515	473	630
CSX-710	1117	1547	479	902	508	254	928	200	13x9	708	730	481,5	316	1298	1160	14	890	930	515	520	630
CSX-800	1250	1665,5	533	1010	563	283,5	1037	250	13x9	798	762	535	358,5	1362	1219	14	980	1050	515	574,5	630
CSX-900	1408	1525	595	1130	625	312,5	1160	300	13x9	898	850	604	407	1424	1281	14	1080	1150	515	636,5	630
CSX-1000	1546	2016	663	1260	693	346,5	1297	350	13x9	998	900	651	433	1600	1456	14	1180	1250	642	690	742

Curvas características

Q= Caudal en m³/h, m³/s y cfm.

Pe= Presión estática en mmH₂O, Pa e inwg.

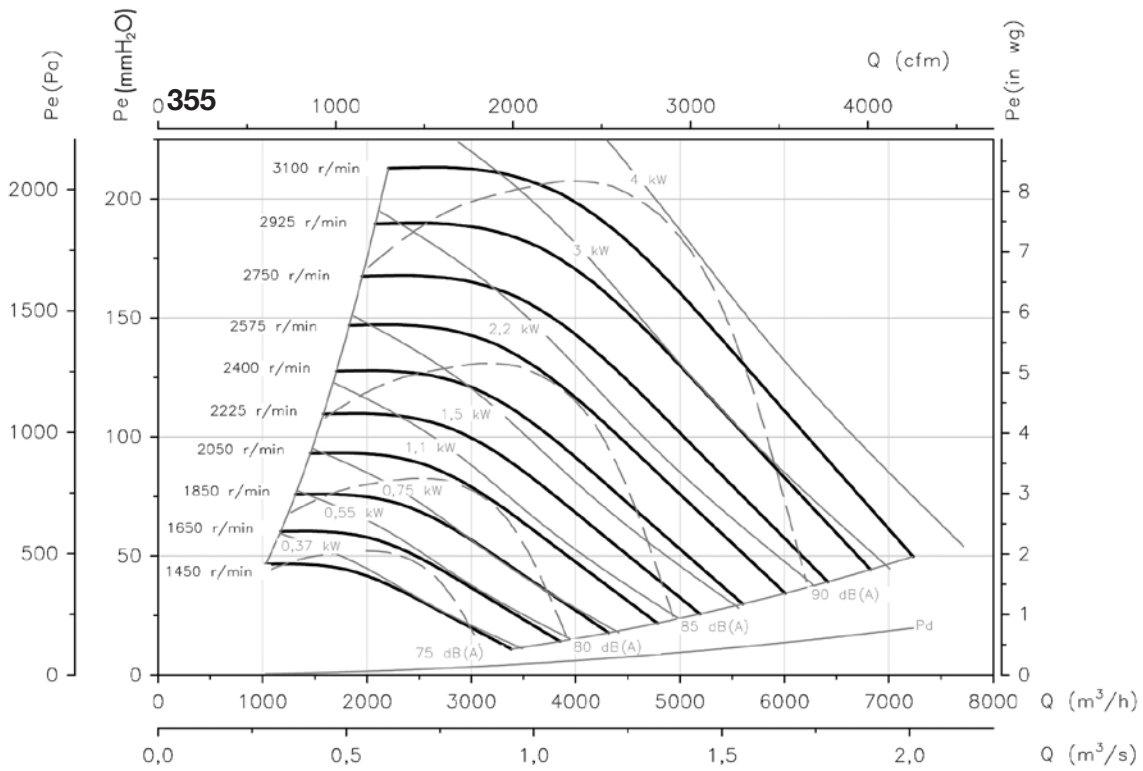
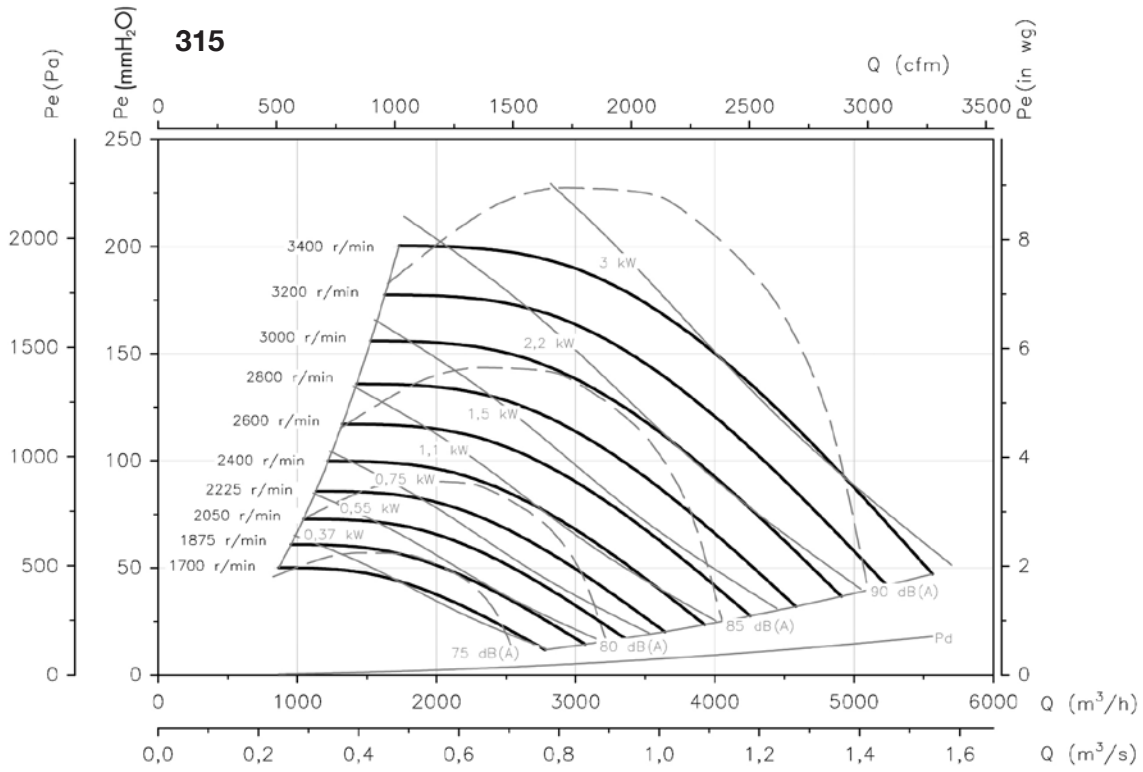

Curvas características

Q= Caudal en m³/h, m³/s y cfm.

Pe= Presión estática en mmH₂O, Pa e inwg.

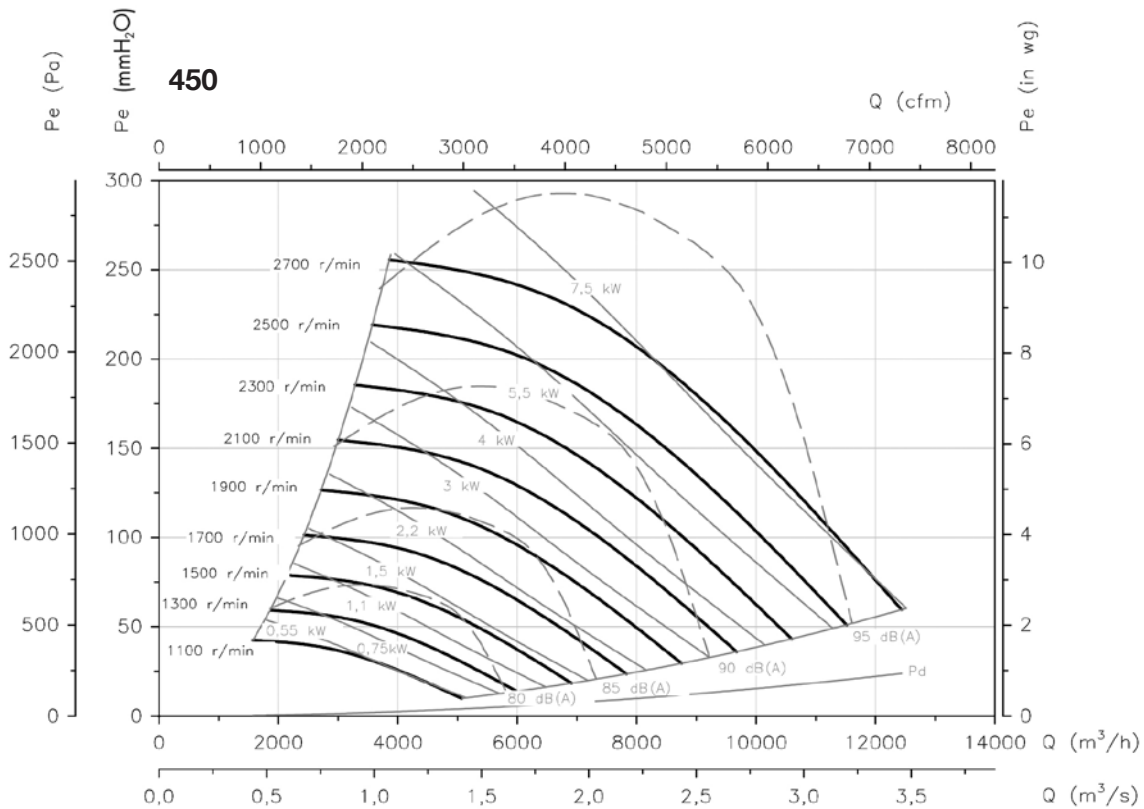
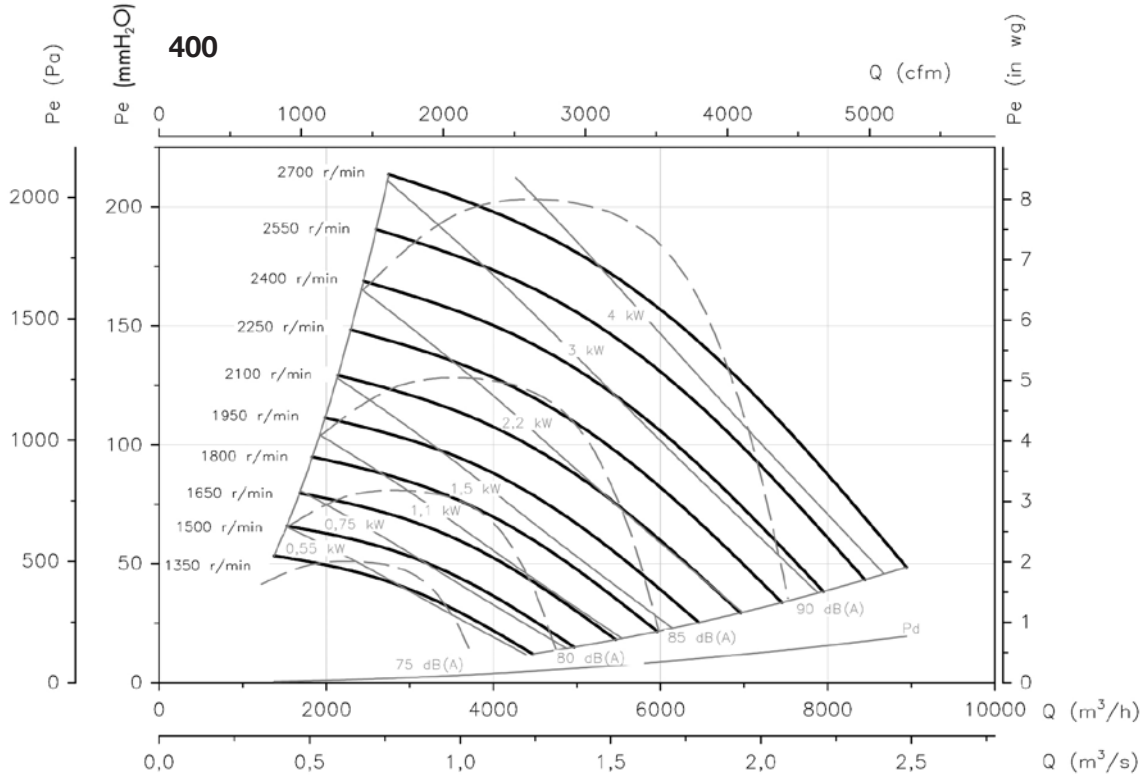

Curvas características

Q= Caudal en m³/h, m³/s y cfm.

Pe= Presión estática en mmH₂O, Pa e inwg.

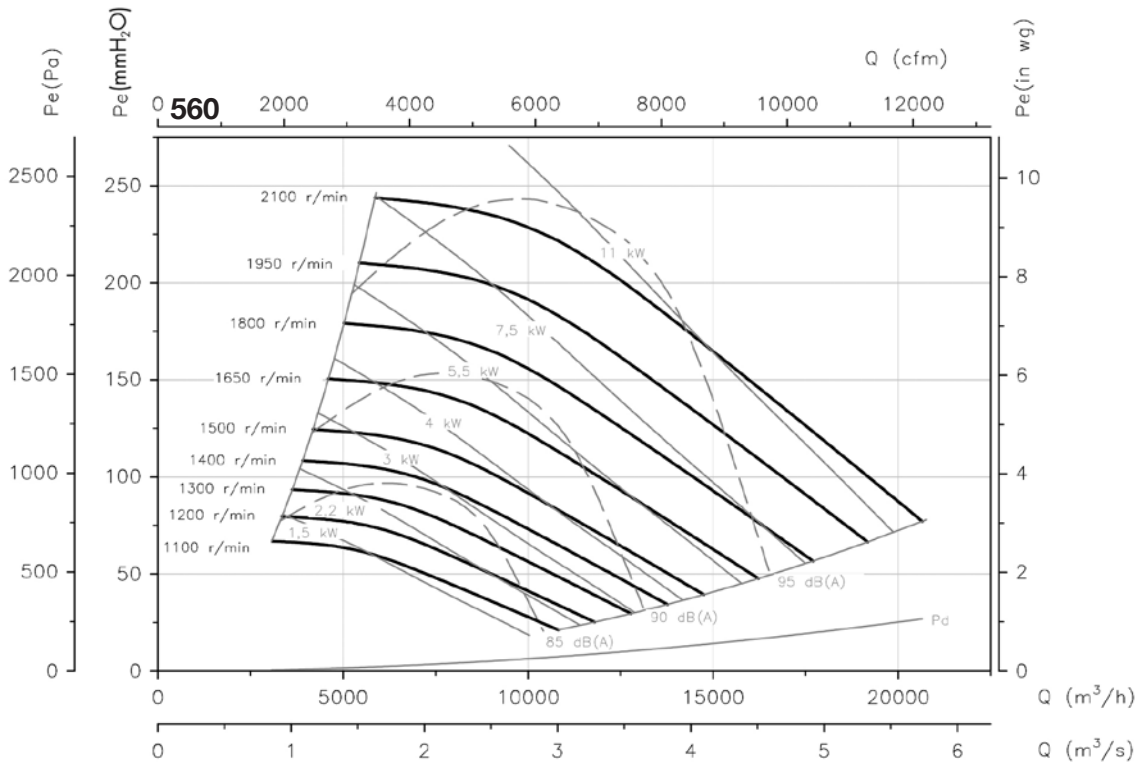
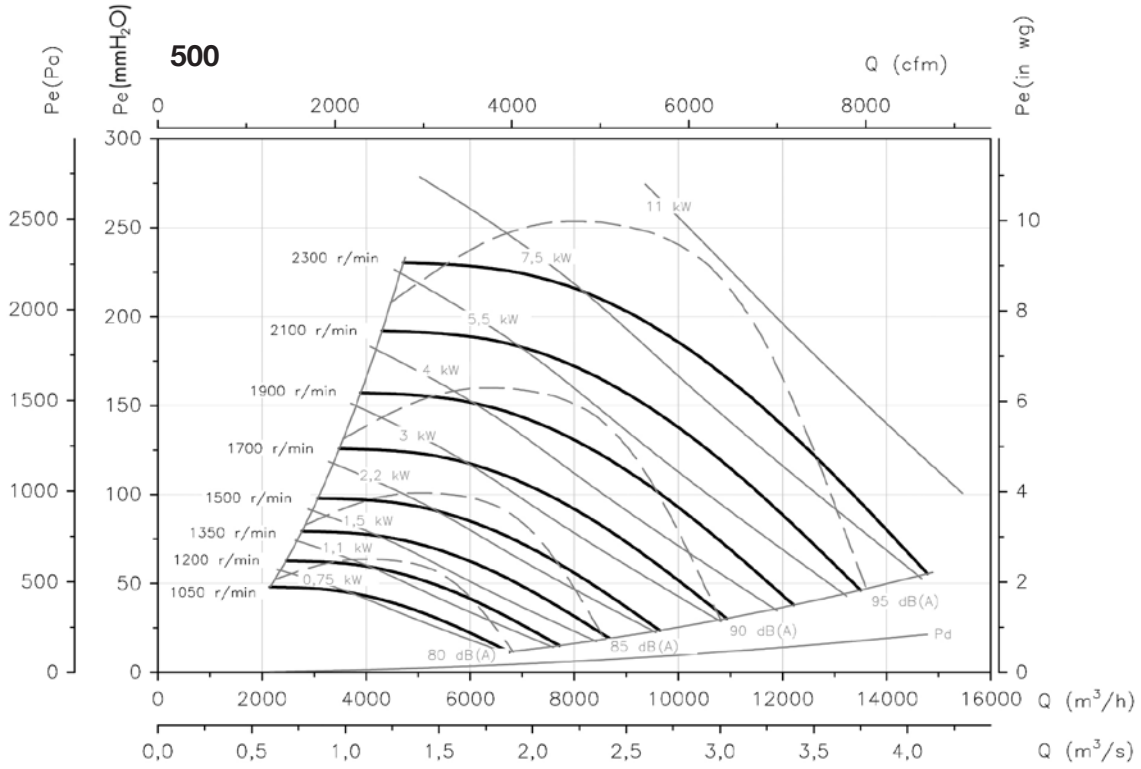

Curvas características

Q= Caudal en m³/h, m³/s y cfm.

Pe= Presión estática en mmH₂O, Pa e inwg.

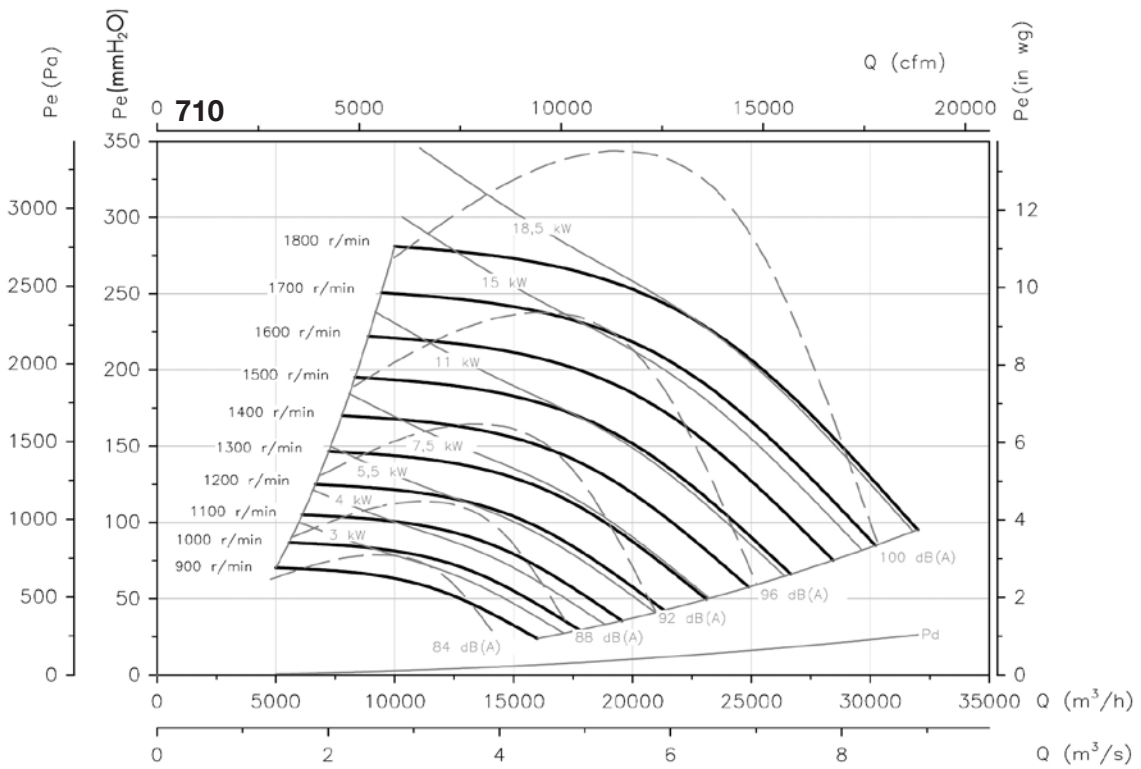
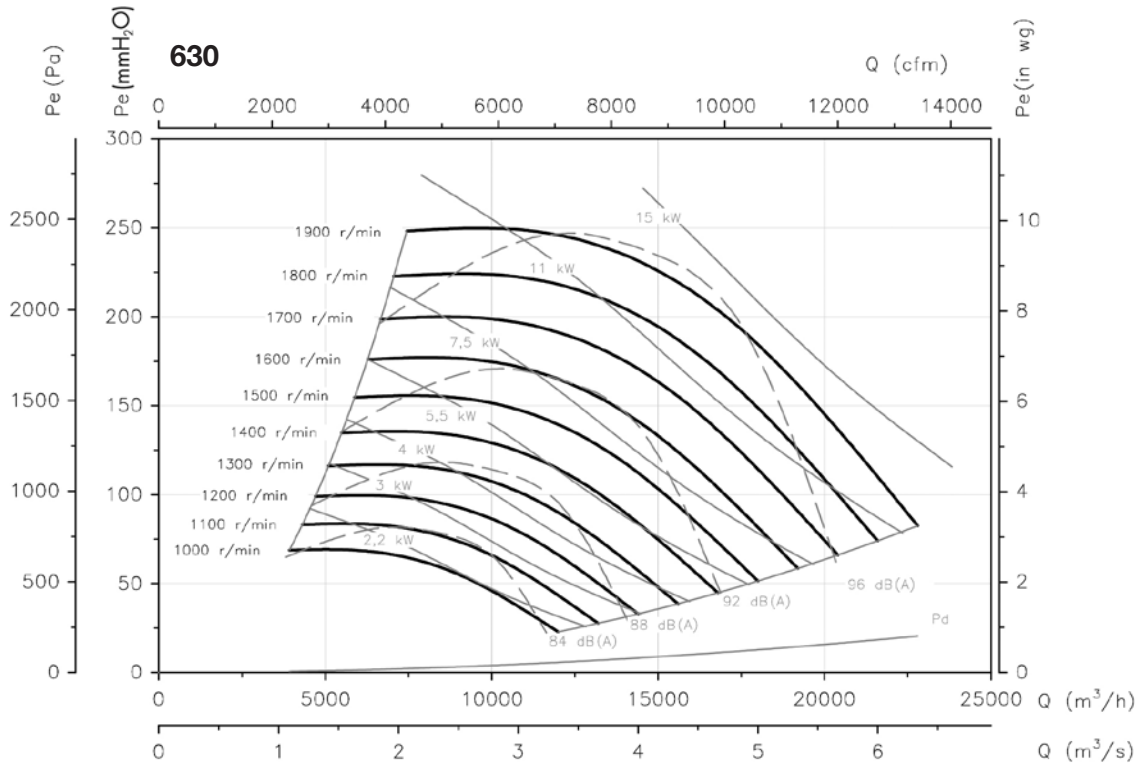

Curvas características

Q= Caudal en m³/h, m³/s y cfm.

Pe= Presión estática en mmH₂O, Pa e inwg.

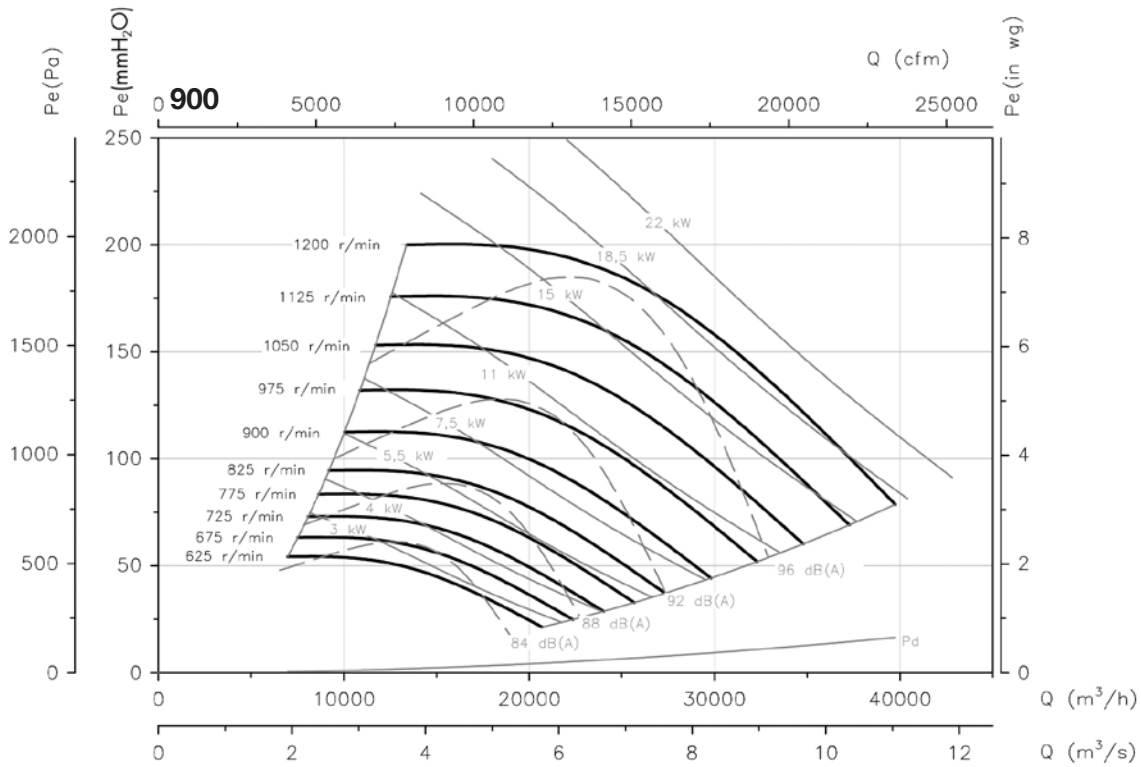
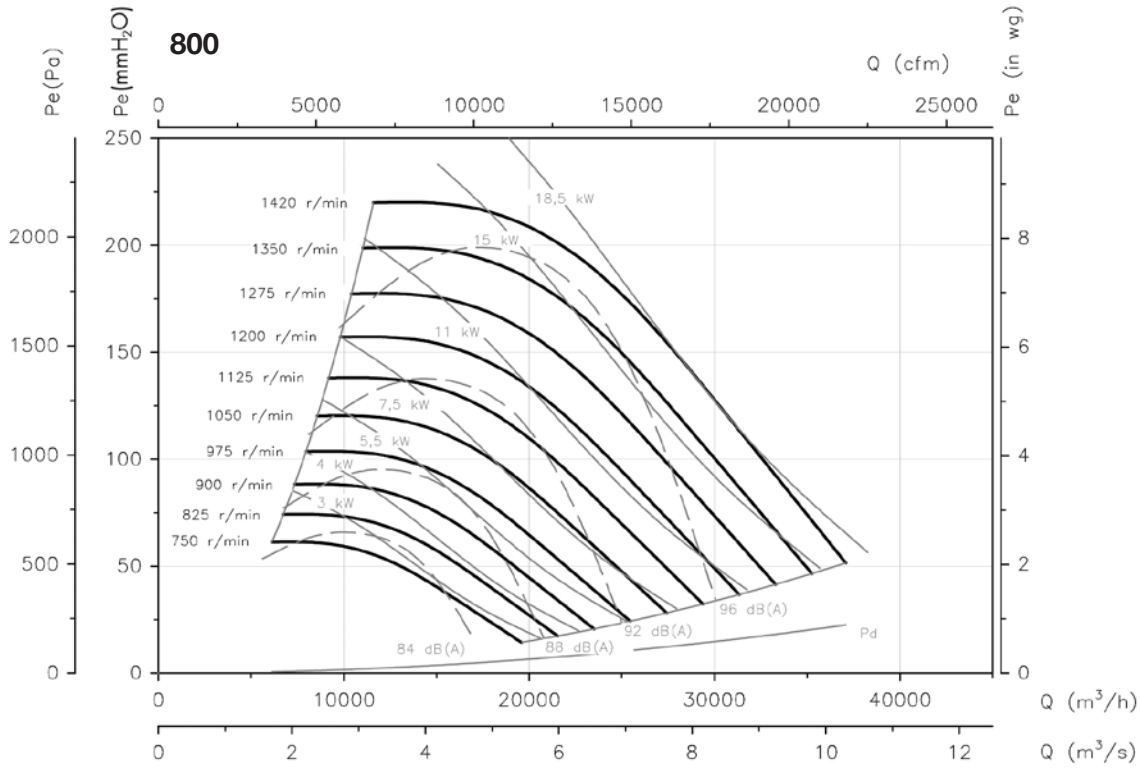

Curvas características

Q= Caudal en m³/h, m³/s y cfm.

Pe= Presión estática en mmH₂O, Pa e inwg.

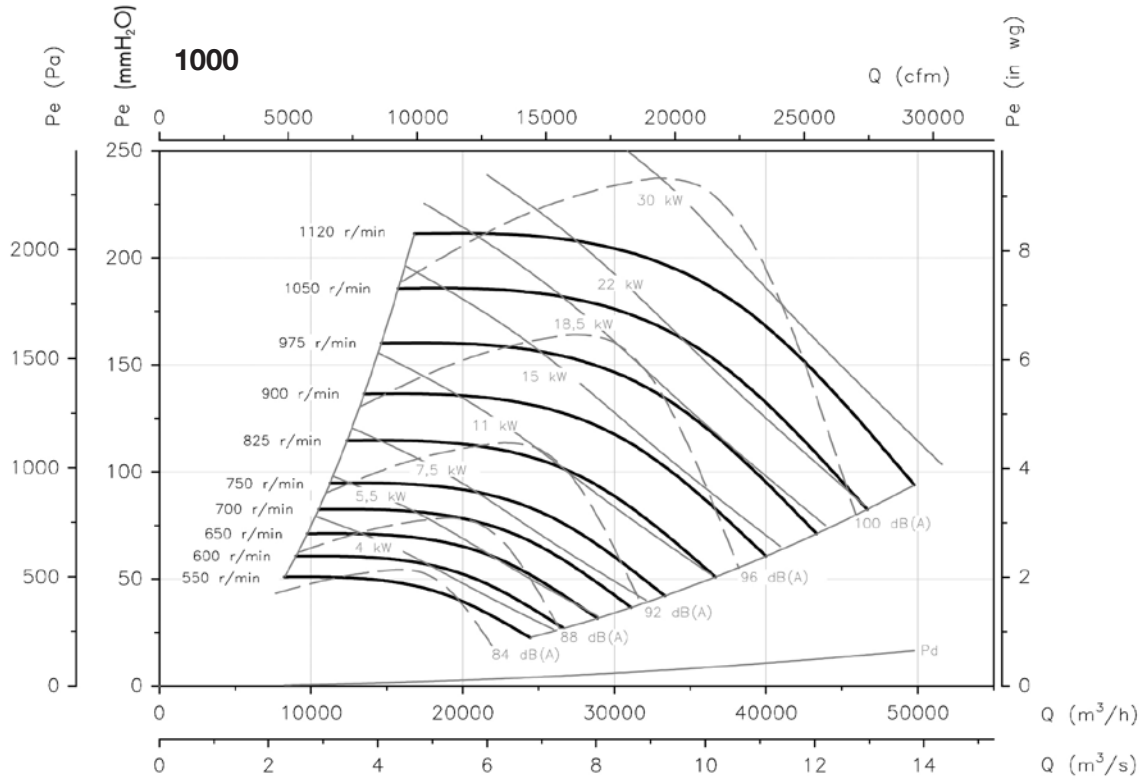

Accesorios

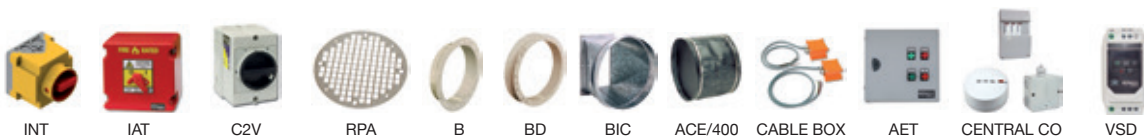

SOBREPRESIÓN DE ESCALERAS

374

KIT SOBREPRESIÓN

Sistema de presurización de escaleras, vías de escape o de confinamiento

381

KIT BOXPDS

Equipos de presurización para escaleras, rutas de escape y vestíbulos

385

HATCH PDS

Equipos de presurización para escaleras, rutas de escape y vestíbulos

387



SISTEMAS DE CONTROL DE PRESURIZACIÓN

Los sistemas de control de presurización de SODECA han sido diseñados de acuerdo a los estándares europeos y a la norma europea "EN 12101-6 Smoke and heat control systems: Specifications for pressure differential systems.

El método de control de humo por sobrepresión consiste en la presurización mediante inyección de aire en habitáculos que son utilizados como vías de escape de personas en caso de incendio, tales como cajas de escalera, pasillos, corredores, elevadores, etc. Este método está basado en el control de humo mediante la velocidad del aire y la barrera artificial que crea la sobrepresión.

Acorde con la norma europea existen diferentes clases de sistemas de presión diferencial en los edificios según su uso.

Clase de sistema	Ejemplos de uso
Sistema de clase A	Para medios de escape. Defensa in situ
Sistema de clase B	Para medios de escape y lucha contra incendios
Sistema de clase C	Para medios de escape mediante evacuación simultánea
Sistema de clase D	Para medios de escape. Riesgo de personas dormidas
Sistema de clase E	Para medios de escape, con evacuación por fases
Sistema de clase F	Sistemas contra incendios y medios de escape

Para la elección y la clasificación del sistema en cada caso hay que tener en cuenta el uso del edificio, su tamaño y las instrucciones de evacuación en caso de incendio, ya que esta elección determina el caudal necesario que debe entregar el equipo de presurización. Es muy importante prestar especial atención a la elección de los mismos ya que según la clase de sistema se requerirán diferentes tipos de caudal.

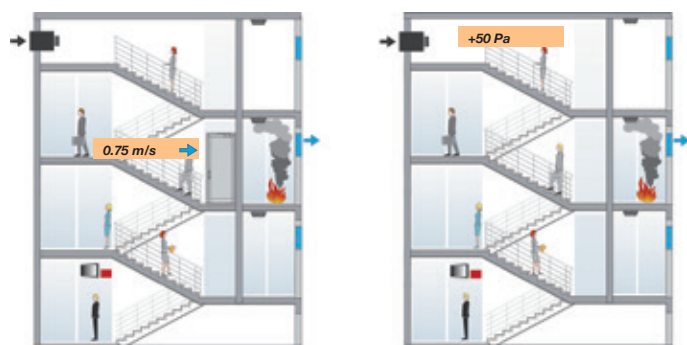

CLASES DE SISTEMAS

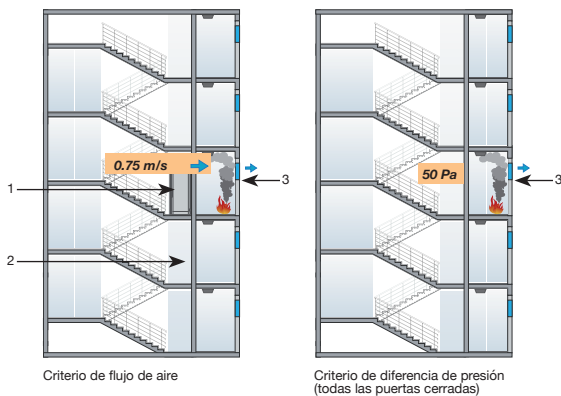

SISTEMA CLASE A

Las condiciones de diseño se basan en la suposición de que un edificio no deberá ser evacuado, a menos que esté directamente amenazado por el incendio.

El nivel de compartimentación de fuego es normalmente seguro para los ocupantes que permanecen dentro del edificio.

Por lo tanto, es poco probable que en el espacio protegido estén abiertas simultáneamente más de una puerta (ya sea entre la escalera y el vestíbulo / pasillo o la puerta de salida final).

1. Puerta abierta
 2. Puerta cerrada
 3. Paso de emisión de aire
- *La puerta abierta puede indicar un paso libre de aire a través de un vestíbulo único

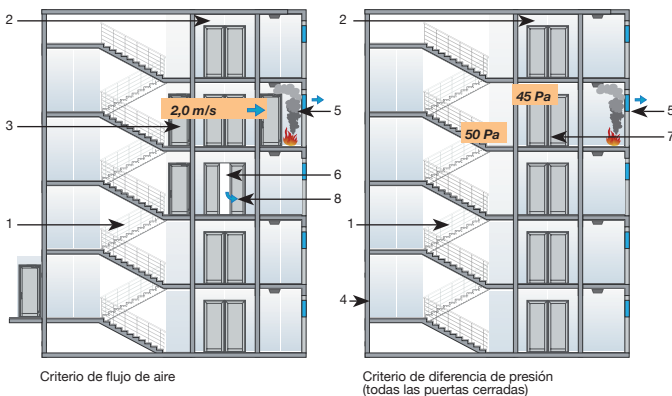

SISTEMA CLASE B

Un sistema de presión diferencial de clase B se puede utilizar para reducir al mínimo la posibilidad de contaminación grave por humo de los puestos de control contra incendios, durante las operaciones de evacuación de personas y de los servicios de extinción.

Durante las operaciones de extinción será necesario abrir la puerta entre el vestíbulo y el alojamiento para hacer frente a un incendio potencialmente desarrollado.

1. Escaleras de incendios
2. Vestíbulos para bomberos
3. Puerta abierta
4. Puerta cerrada
5. Aberturas de escape de aire
6. Puerta abierta (vestíbulos para bomberos)
7. Puerta cerrada (vestíbulos para bomberos)
8. Flujo de aire desde el pozo del ascensor de bomberos

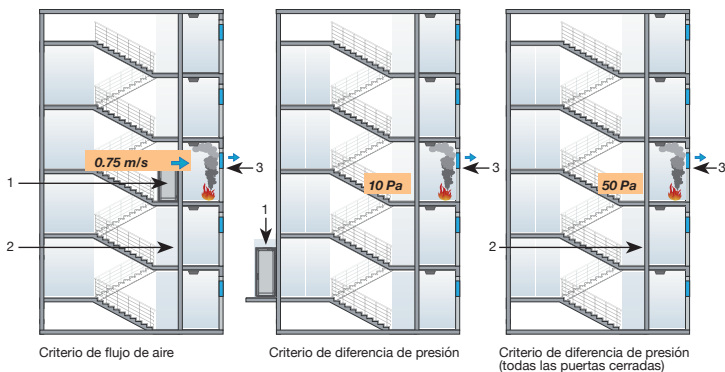

SISTEMA CLASE C

Las condiciones de diseño para sistemas de clase C se basan en la hipótesis de que los ocupantes del edificio serán evacuados de forma simultánea al activarse la señal de alarma de incendio.

En el caso de una evacuación simultánea se supone que las escaleras serán ocupadas para el período nominal de la evacuación y posteriormente, estará libre de personas. En consecuencia, la evacuación se producirá durante las primeras fases de desarrollo del incendio, etapa durante la cual puede aceptarse cierta fuga de humo hacia la escalera.

El flujo de aire aportado por el sistema de presurización deberá eliminar dicho humo de la escalera.

Se supone que los ocupantes durante la evacuación se mantienen atentos y preparados y conocen el entorno por el que se mueven, minimizando así el tiempo de permanencia en el edificio.

1. Puerta abierta
 2. Puerta cerrada
 3. Aberturas de escape aire
- *La figura puede incluir vestíbulos

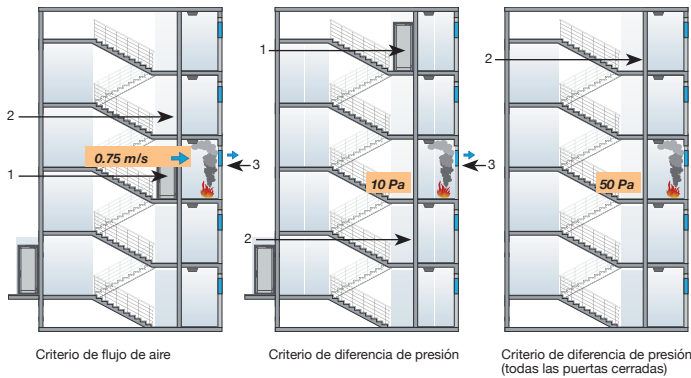

SISTEMA CLASE D

Los sistemas de clase D están diseñados en edificios donde los ocupantes puedan estar durmiendo, por ejemplo: hoteles, albergues y edificios de tipo institucional. El tiempo para que los ocupantes se muevan en un área protegida antes de alcanzar la salida final, puede ser mayor que la esperada en el caso de personas despiertas y en buenas condiciones físicas y los ocupantes pueden no estar familiarizados con el edificio o necesitan ayuda para llegar a la salida final / al espacio protegido.

1. Puerta abierta
 2. Puerta cerrada
 3. Aberturas de escape aire
- *La figura puede incluir vestíbulos

1. Puerta abierta
 2. Puerta cerrada
 3. Aberturas de escape aire
- *La figura puede incluir vestíbulos

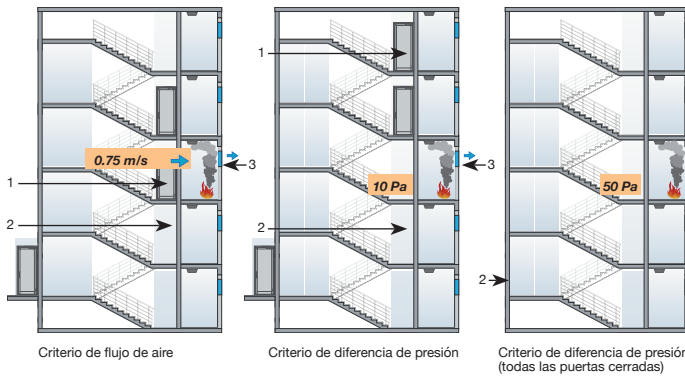

SISTEMA CLASE E

Se aplican en edificios donde la evacuación en caso de incendio se realiza por fases o de forma escalonada.

En el escenario de "evacuación por fases" se considera que el edificio aún estaría ocupado durante un tiempo considerable, mientras que el fuego se está desarrollando, por lo que deberán considerarse mayores cargas de fuego y por consiguiente, mayor cantidad de humo y gases calientes. (Estos factores pueden variar significativamente, según el tipo de materiales en combustión, carga de fuego generada por estos y geometría de dicha carga).

En una situación así, las escaleras protegidas deberán mantenerse libres de humo para asegurar la evacuación segura de las personas que ocupan las plantas no incendiadas.

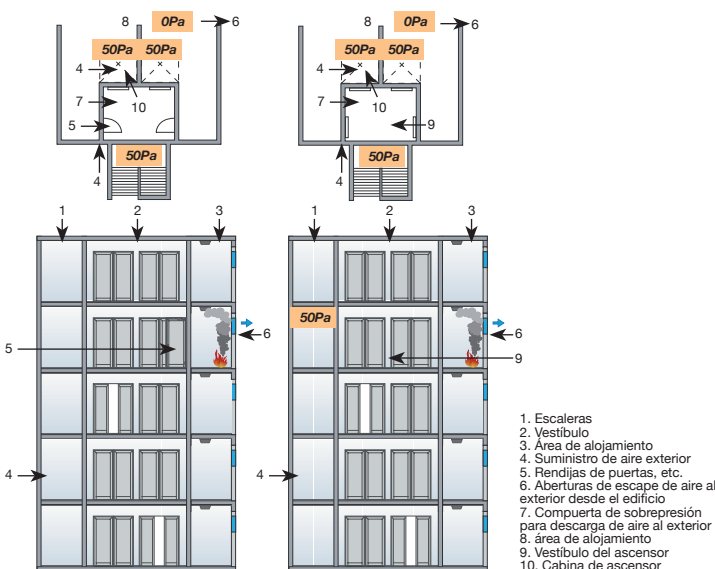

SISTEMA CLASE F

El sistema clase F se aplica para reducir al mínimo las posibilidades de contaminación grave por humo en las cajas de escalera empleadas por los servicios de extinción, tanto durante los procesos de evacuación de personas, como durante la actuación contra incendios de dichos servicios.

Durante las operaciones de extinción será necesario abrir la puerta entre el vestíbulo y el alojamiento para hacer frente a un incendio potencialmente desarrollado.

El sistema debe diseñarse de forma que en la caja de escalera y donde lo haya, el pozo de ascensor, se mantengan libres de humo. En caso que éste entre en el vestíbulo, la presión dentro de la escalera no debe conducir el humo hasta el hueco, ni viceversa.



Criterio de diferencia de presión

CLASE DE SISTEMA	A	B	C	D	E	F
Diferencia de presión entre escalera y alojamiento (Todas las puertas cerradas)	50 Pa	50 Pa	50 Pa	50 Pa	50 Pa	50 Pa
Diferencia de presión a ambos lados de la puerta del alojamiento (Puerta de salida final abierta)	-	-	10 Pa	10 Pa	10 Pa	-
Puertas abiertas (Criterio diferencia de presión) Salida final al exterior	NO	NO	SI	SI	SI	NO
Puertas abiertas (Criterio diferencia de presión) Planta de incendio	NO	NO	NO	NO	NO	NO
Puertas abiertas (Criterio diferencia de presión) Nº de plantas distintas a la del incendio	0	0	0	1	2	0
Diferencia de presión (entre vestíbulo y alojamiento)	45 Pa*	45 Pa	45 Pa*	45 Pa*	45 Pa*	45 Pa
Diferencia de presión (entre pozo ascensor y alojamiento)	-	50 Pa	-	-	-	50 Pa

Criterio de flujo de aire

CLASE DE SISTEMA	A	B	C	D	E	F	
						Situación 1	Situación 2
Velocidad de aire en puerta de planta de incendio (Puertas abiertas)	-	2 m/s	0,75 m/s	0,75 m/s	0,75 m/s	-	1 m/s
Velocidad de aire en puerta de escalera en planta de incendio (Puertas abiertas)	0,75 m/s	-	-	-	-	2 m/s	-
Puertas abiertas Salida final al exterior	NO	SI	NO	SI	SI	SI	SI
Puertas abiertas Ascensor	NO	SI	NO	NO	NO	SI	NO
Puertas abiertas Escalera – vestíbulo en planta de incendio	SI	SI	SI	SI	SI	SI	NO
Puertas abiertas Escalera – vestíbulo en planta distinta de la del incendio	NO	SI	NO	NO	NO	SI	NO
Puertas abiertas Planta de incendio	SI	SI	SI	SI	SI	SI	SI
Puertas abiertas Nº de plantas distintas a la del incendio	0	0	0	0	1	0	0

*La presurización de los vestíbulos no es obligatoria cuando solo cuenta con las puertas que comunican éstos con la escalera y las plantas.



Tiempo de respuesta

Todos los sistemas deben diseñarse de tal modo que la fuerza a aplicar en el tirador de la puerta para abrirla no supere los 100N.

Los equipos SODECA incorporan controles de última generación para satisfacer la máxima exigencia y fiabilidad a los cambios de situaciones que se pueden producir durante un incendio, como las situaciones de evacuación "caóticas" en las que se abren y cierran puertas entre las zonas de incendio y las zonas presurizadas libres de humo de forma aleatoria.

Nuestros sistemas son capaces de reaccionar de forma rápida y precisa a estos cambios, asegurando siempre una Sobrepresión de 50Pa en situación de puertas cerradas y mantener la velocidad de aire exigida en cada situación de puerta abierta. Esta capacidad de respuesta asegura que la fuerza a aplicar para abrir una puerta no supere los 100N tal como indican los estándares europeos.

- t1: Apertura de puerta (1 segundo)
- t2: Puerta abierta: El sistema entrega el 100% del caudal necesario en menos de 6 segundos
- t3: Cierre de puerta (3 segundos)

Los equipos SODECA son capaces de cumplir con los siguientes tiempos de reacción:

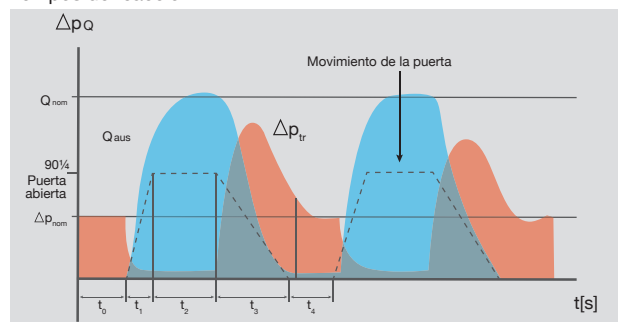

t4: Puerta cerrada: El sistema adquiere la presión nominal en menos de 6 segundos, evitando así un exceso de presión prolongado asegurando que la fuerza a aplicar en el tirador de la puerta no sea mayor de 100N.

Q= Caudal
P= Presión

Ejemplos de aplicación

Los sistemas SODECA ofrecen distintas tipologías de equipos para satisfacer todas las necesidades de instalación según el edificio al cual se aplique un Sistema de control de presurización.

Es importante tener en cuenta durante la elección del equipo donde se instalará, determinando como se realizarán la aspiración de aire del exterior y la impulsión a la zona presurizada, considerando las siguientes recomendaciones:

Aspiración del aire exterior:

La toma de aire del exterior debe estar lejos de zonas con riesgo de incendio para asegurar la entrada de aire limpio a través del sistema de presurización. En caso de instalación en cubierta, serán necesarias dos tomas de aire alejadas entre sí, equipándolas con sistemas de detección de humo, de forma que si a través de una de las bocas se aspira humo, ésta deberá poder cerrarse de forma automática mediante una persiana motorizada (KIT DAMPER) u otro sistema equivalente.

Impulsión del aire al interior:

Se acepta un solo punto de impulsión de aire a la zona presurizada para edificios inferiores a 11 metros de altura, para edificios de más altura deberá asegurarse un punto de entrada de aire cada 3 plantas, por ejemplo, usando difusores y un conducto de aire a lo largo de toda la escalera.

En sala técnica

KIT BOXPDS / KIT SOBREPRESIÓN



En cubierta

KIT BOXPDS / HATCH PDS / KIT SOBREPRESIÓN

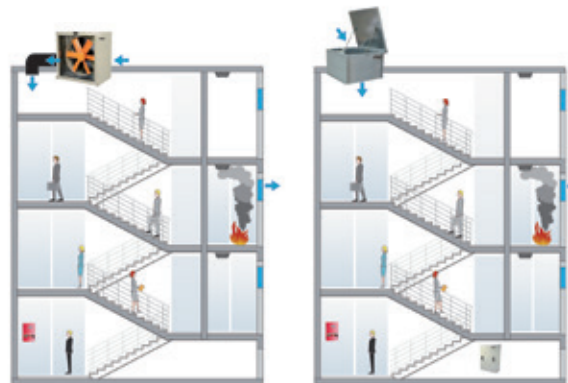

En vestíbulo independiente

PRESSKIT / KIT SOBREPRESIÓN

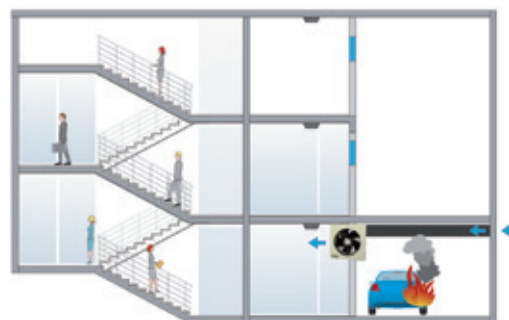



PRUEBAS DE SIMULACIÓN REALES

Todos los equipos fabricados por SODECA son sometidos a rigurosas pruebas en entornos de simulación reales, usando nuestras instalaciones y nuestra cámara de pruebas con puertas resistentes al fuego, dampers motorizados para simulación de fugas y simulación de apertura/cierre de puerta temporizadas, de acuerdo con la norma EN-12101-6 Smoke and heat control systems: Specifications for pressure differential systems.

Equipos certificados por laboratorios independientes



Certificado: NR331151



EN-12101-6
Smoke and heat control
systems: Specifications
for pressure differential systems

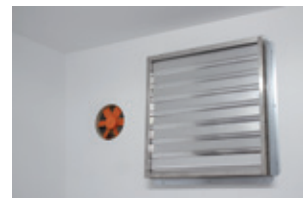
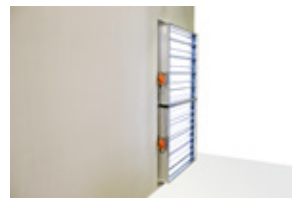

CONTROL PUESTA EN MARCHA MEDIANTE REMOTE CONNECT

SODECA va más allá y se adapta a las nuevas necesidades del mercado para dar respuesta a las nuevas demandas tecnológicas, de forma que nuestros sistemas ofrecen opciones avanzadas y de conectividad para facilitar la supervisión y el mantenimiento de los equipos una vez instalados en cualquier edificación.

Utilizando el protocolo Modbus se puede interconectar cualquier sistema BMS (Building management system) con nuestros equipos de forma que el usuario final o los servicios de mantenimiento puedan supervisar en todo momento el estado y el correcto funcionamiento de los mismos.

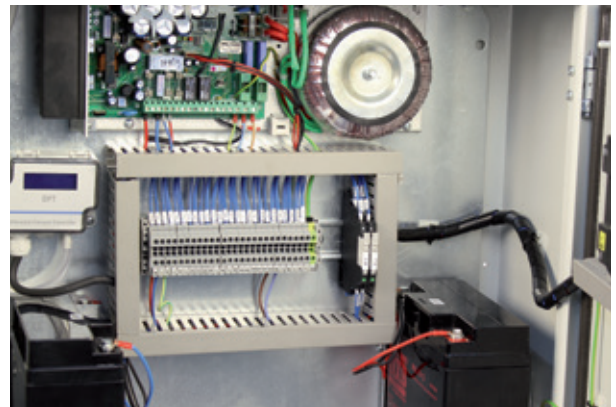

KIT SOBREPRESIÓN

El sistema de presurización de escaleras, vías de escape o de confinamiento, permite controlar de forma automática el caudal y mantener una presión diferencial de 50 Pa en una sola etapa, según norma UNE EN 12101-6-2006

KIT SOBREPRESIÓN DE ESCALERAS
Para equipos trifásicos



KIT SOBREPRESIÓN DE ESCALERAS

- Kit sobrepresión de escaleras, formado por un cuadro de control (BOXPRES KIT) y unidades de impulsión (CJHCH o CJBD), para la presurización de las escaleras y rutas de escape. También disponible para equipos monofásicos NEOLINEO Y CJBC.

KIT SOBREPRESIÓN CON VENTILADOR DE RESERVA

- Kit de sobrepresión con ventilador de reserva, formado por un cuadro de control (BOXPRES KIT II), que incorpora un sistema de conmutación automático para mantener la sobrepresión en caso de fallo del ventilador principal, y unidades de impulsión de aire con ventilador de reserva serie TWIN o CJHCH/DUPLEX.

KIT SOBREPRESIÓN DE ESCALERAS
Para equipos monofásicos



BOXPRES



- Fácil instalación
- Solución compacta y autónoma
- Mantenimiento preventivo
- Fácil puesta en marcha
- Instalación segura y funcional



- El buen funcionamiento de los sistemas de presurización, depende no solo del buen diseño de los mismos, sino también de la buena regulación que realice el sistema, por lo que es de vital importancia contar con elementos de regulación calibrados y de gran precisión, que permitan simultanear las dos situaciones presentes en caso de incendio, de forma rápida y estable.
- El cuadro de control BOXPRES, además de cumplir con las máximas exigencias, simplifica al máximo el trabajo del instalador.

KIT SOBREPRESIÓN CON
VENTILADOR DE RESERVA



Incluye:

- Variador de frecuencia programado a 50 Pa
- Sonda de presión diferencial
- Magneto térmico
- Led de línea y fallo
- Pulsador de chequeo

BOXPRES, es un equipo con todas sus conexiones entre sí realizadas y probadas

- Listo para funcionar y desempeñar su función sobre el control de la presión de la instalación.
- Posibilidad de chequeo de la instalación para evitar fallos
- Solo se debe conectar la línea de alimentación, el ventilador de impulsión y la señal de incendio.

Los cuadros para equipos monofásicos incluyen:

- Regulador de tensión programado a 50 Pa
- Sonda de presión diferencial externa al equipo.

Código de pedido

KIT SOBREPRESIÓN — 7.100 — 60Hz

Kit sobrepresión: Conjunto de sobrepresión para escaleras
Kit sobrepresión II: Conjunto de sobrepresión con ventilador de reserva

Caudal máximo

Características técnicas

Modelo	Alimentación	Salida	Unidad de impulsión	Caudal (m ³ /h)	Nivel sonoro irradiado * dB(A)
KIT SOBREPRESION-1060-LED	230 Vac II	230 Vac II	NEOLINEO-200	1060	38
KIT SOBREPRESION-2300-LED	230 Vac II	230 Vac II	NEOLINEO-315	2300	47
KIT SOBREPRESION-2880-LED	230 Vac II	230 Vac II	CJBC-2828-6M 1/3	2880	61
KIT SOBREPRESION-7100-LED	230 Vac II	230 Vac III	CJHCH-45-4T-0,5	7100	55
KIT SOBREPRESION-7800-LED	230 Vac II	230 Vac III	CJBD-3333-6T-1,5	7800	55
KIT SOBREPRESION-12900-LED	230 Vac II	230 Vac III	CJHCH-56-4T-1	12900	60
KIT SOBREPRESION-17000-LED	230 Vac II	230 Vac III	CJHCH-63-4T-1,5	17000	61
KIT SOBREPRESION-7100-BOX	400 Vac III	400 Vac III	CJHCH-45-4T-0,5	7100	55
KIT SOBREPRESION-7800-BOX	400 Vac III	400 Vac III	CJBD-3333-6T-1,5	7800	55
KIT SOBREPRESION-12900-BOX	400 Vac III	400 Vac III	CJHCH-56-4T-1	12900	60
KIT SOBREPRESION-17000-BOX	400 Vac III	400 Vac III	CJHCH-63-4T-1,5	17000	61
KIT SOBREPRESION II-6240-BOX	400 Vac III	400 Vac III	TWIN-12/12-6T-1,5	6240	55
KIT SOBREPRESION II-9520-BOX	400 Vac III	400 Vac III	TWIN-15/15-6T-3	9520	54
KIT SOBREPRESION II-12900-BOX	400 Vac III	400 Vac III	CJHCH/DUPLEX-56-4T-1-H	12900	60
KIT SOBREPRESION II-17000-BOX	400 Vac III	400 Vac III	CJHCH/DUPLEX-63-4T-1,5-H	17000	61
SI-PRESIÓN TPDA					
SI-PRESIÓN TPDA c/DISPLAY					
BOXPRES KIT-3A 230Vac	230 Vac II	230 Vac II			
BOXPRES KIT-10A 230Vac	230 Vac II	230 Vac II			
BOXPRES KIT-0,75KW 230Vac	230 Vac II	230 Vac III			
BOXPRES KIT-1,5KW 230Vac	230 Vac II	230 Vac III			
BOXPRES KIT-0,75KW 400Vac	400 Vac III	400 Vac III			
BOXPRES KIT-1,5KW 400Vac	400 Vac III	400 Vac III			
BOXPRES KIT-2,2KW 400Vac	400 Vac III	400 Vac III			
BOXPRES KIT II - 1,5KW 400Vac	400 Vac III	400 Vac III			
BOXPRES KIT II - 2,2KW 400Vac	400 Vac III	400 Vac III			

Dimensiones mm

CJHCH

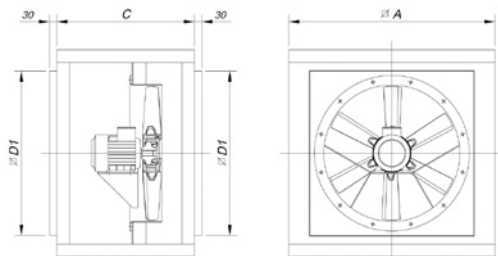

Modelo	∅A	C	∅D1
CJHCH-40/45/50	700	550	565
CJHCH-56/63	825	550	690

CJBD

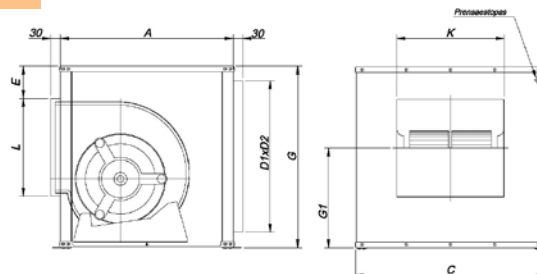

Modelo	Equiv. pulgadas	A	B	C	E	D1x02	G1	L	K
CJBD-3333	12/12	650	650	700	92	556X606	379	358	400

Dimensiones mm

TWIN

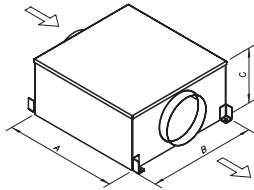

Modelo	A	B	C
TWIN-12/12	1103	1139	610
TWIN 15/15	1279	1639	698

CJHCH/DUPLEX

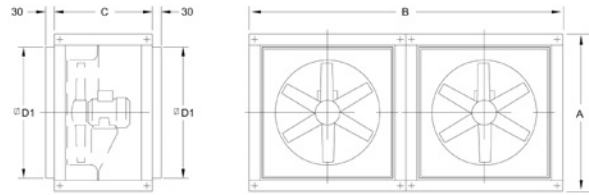

Modelo	ØA	B	C	ØD1
CJHCH/DUPLEX-56/63	825	1650	550	690

NEOLINEO

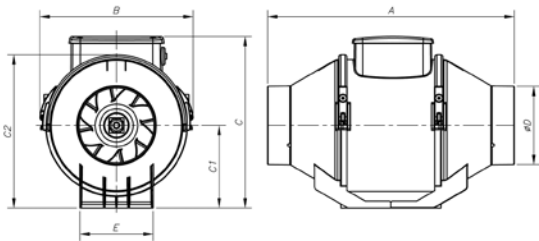

Modelo	A	B	C	C1	C2	øD	E
NEOLINEO-200	300	234,5	260,5	125,5	235	196	140
NEOLINEO-315	448	361,5	392,5	188,5	359	312	220,5

CJBC

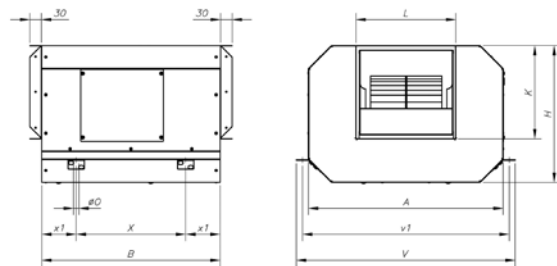

Modelo	A	B	H	K	L	øO	V	v1	X	x1
CJBC-2828-6M-1/3	696	645	460	290	320	15	755	725	445	100

BOXPRESS KIT SOBREPRESIÓN

Características técnicas y dimensiones

Modelo	Potencia kW	Alimentación (V/Hz)	Salida (V/Hz)	Intensidad salida (A)	Tamaño	Medidas (largo x ancho x fondo)
BOXPRES KIT-3A 230Vac	-	380 Vac II	380 Vac II	3	-	255 x 170 x 140 mm
BOXPRES KIT-10A 230Vac	-	380 Vac II	380 Vac II	10	-	255 x 170 x 140 mm
BOXPRES KIT-0,75kW 230Vac	0,75	220 V II / 60Hz	220 V II / 60Hz	4,3	1	270x270x170mm
BOXPRES KIT-1,5kW 230Vac	1,5	220 V II / 60Hz	220 V II / 60Hz	7	1	270x270x170mm
BOXPRES KIT-0,75KW 400Vac	0,75	380 V III / 60Hz	380 V III / 60Hz	2,2	1	270x270x170mm
BOXPRES KIT-1,5KW 400Vac	1,5	380 V III / 60Hz	380 V III / 60Hz	4,1	1	270x270x170mm
BOXPRES KIT-2,2KW 400Vac	2,2	380 V III / 60Hz	380 V III / 60Hz	5,8	2	360x360x205mm

Prensaestopas de entrada cable a equipo

BOXPRES KIT-3A / KIT-10A

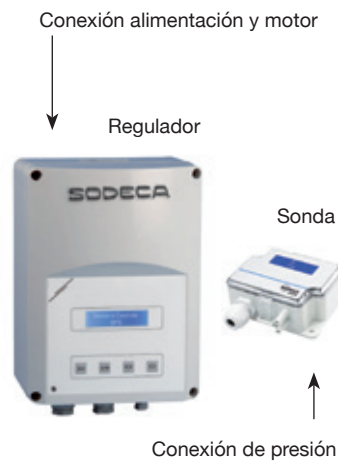

BOXPRES KIT tamaño 1 y 2

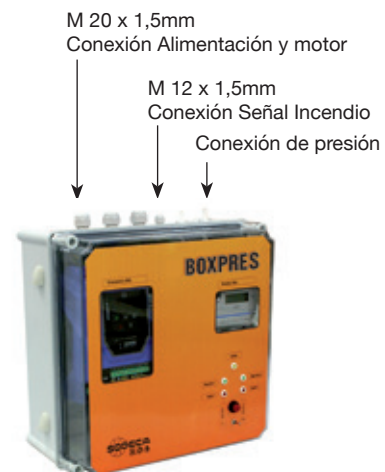

BOXPRESS KIT SOBREPRESIÓN II

Para equipos con ventilador de reserva.

Características técnicas y dimensiones

Modelo	Potencia kW	Alimentación (V/Hz)	Salida (V/Hz)	Intensidad salida (A)	Tamaño	Medidas (largo x ancho x fondo)
BOXPRES KIT II - 1,5KW 400Vac	1,5	380 V III / 60Hz	380 V III / 60Hz	4,1	1	270 x 270 x 170 mm
BOXPRES KIT II - 2,2KW 400Vac	2,2	380 V III / 60Hz	380 V III / 60Hz	5,4	2	360 x 360 x 205 mm

* Los dos motores nunca funcionan simultáneamente

Prensaestopas de entrada cable a equipo**BOXPRES KIT tamaño 1 y 2**

M 20 x 1,5mm
Conexión Alimentación y motor

M 12 x 1,5mm
Conexión Señal Incendio
Conexión de presión

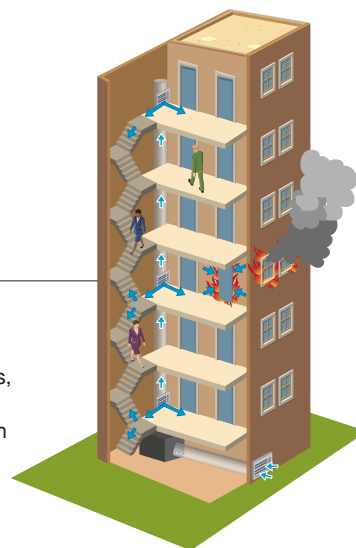
**Ejemplo de aplicación**

Método de control de humo por Sobrepresión, este sistema consiste en la presurización mediante inyección de aire en habitáculos que son utilizados como vías de escape de personas en caso de incendio, tales como cajas de escalera, pasillos, corredores, elevadores, etc. Sobre todo en edificios de altura con gran ocupación. Este método está basado en el control del humo mediante la velocidad del aire y la barrera artificial que crea la sobre presión del aire sobre el humo, para que este no pueda entrar en las vías de escape.

KIT BOXPDS

Equipos de presurización para escaleras, rutas de escape y vestíbulos, de conformidad a la norma europea EN 12101-6

Equipos de presurización de vías de escape en caso de incendio cumpliendo requisitos de la norma europea EN 12101-6. El KIT BOXPDS regula de forma automática el flujo de aire y es capaz de mantener los 50 Pa de sobrepresión aún con presencia de fugas en la instalación. El sistema es capaz de mantener la sobrepresión (Pressure criteria) y una velocidad de 0,75 m/s en caso de puerta abierta (Airflow criteria) de forma casi inmediata.

KIT BOXPDS

- Consta del cuadro de control BOXPDS, una unidad de ventilación CJHCH y un kit Damper con detector óptico de humos incorporado.



- Fácil instalación
- Solución compacta y autónoma
- Mantenimiento preventivo
- Fácil puesta en marcha
- Instalación segura y funcional



BOXPDS

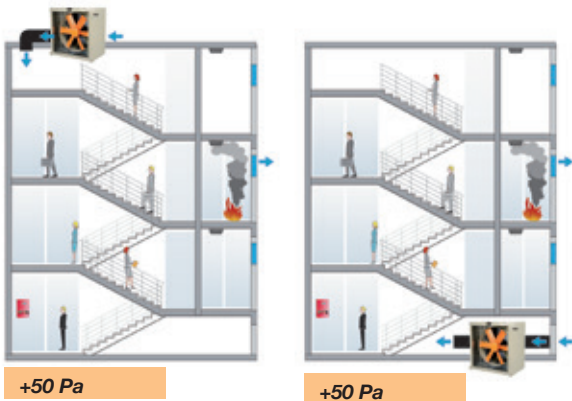

+50 Pa

+50 Pa

BOXPDS

- Variador de frecuencia Inverter.
- Sonda de presión diferencial de gran precisión.
- Cuadro eléctrico con protecciones magnetotérmicas e indicación de fallo en la alimentación general.
- Control electrónico para gestión de alarmas, mantenimiento, puerto ModBUS RTU para conexión a sistemas BMS (Building management systems) y control por DAMPER.
- Fuente de alimentación certificada con baterías para asegurar la alimentación de los equipos de control en caso de fallo en la red eléctrica.



Cuadro de mandos:

- Cuadro de mandos externo para la visualización de la presión a tiempo real, pilotos de alarmas y activación manual del sistema



Código de pedido

KIT BOXPDS — 800 — 5.5 — 60Hz

Equipos de presurización para escaleras, rutas de escape y vestíbulos

Diámetro del ventilador

Potencia en C.V.

60Hz

Características técnicas

Modelo	Velocidad (r/min)	Intensidad máx admisible 400V (A)	Potencia Instalada (kw)	Caudal máximo (m³/h)	NPS irradiado dB(A)	Peso aprox. (Kg)
BOXPDS-710-1.5	1680	2.32	1.1	19750	78,75	188
BOXPDS-710-2	1716	3.44	1.5	21100	78,75	190,5
BOXPDS-710-3	1734	4.83	2.2	23950	81,9	200
BOXPDS-800-3	1734	4.83	2.2	28000	82,95	208
BOXPDS-800-4	1734	6.33	3	32700	84	210
BOXPDS-800-5.5	1728	8.12	4	37200	85,05	215

Dimensiones mm

KIT BOXPDS

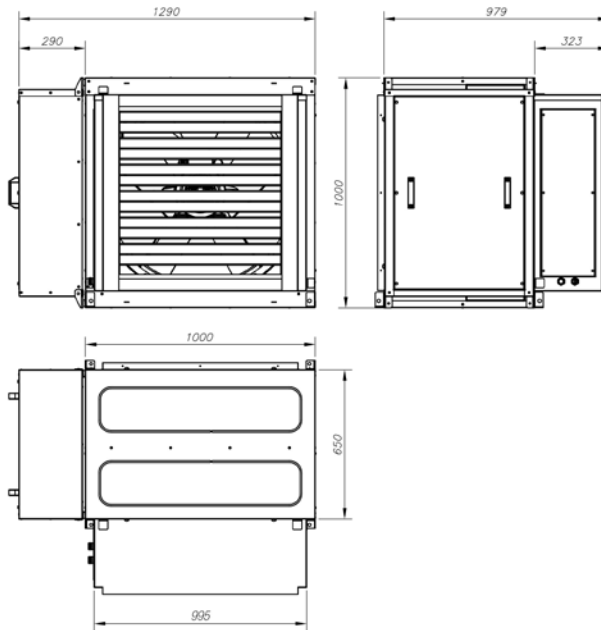
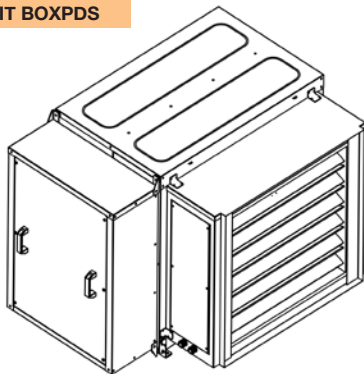

BOXPDS

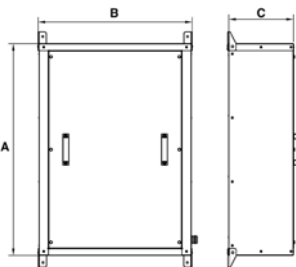

Modelo	A	B	C
BOXPDS	900	650	280

DAMPER

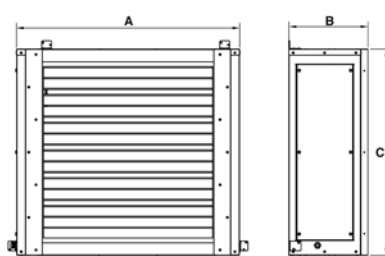

Modelo	A	B	C
DAMPER	995	326,5	855

CJHCH

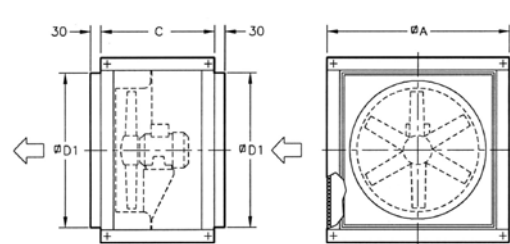

Modelo	ØA	C	ØD1
CJHCH-71/80	1000	650	850

Ejemplos de aplicación

BOXPDS

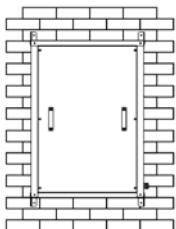

En sala técnica

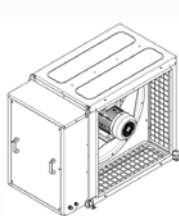

Junto a unidad de ventilación

DAMPER

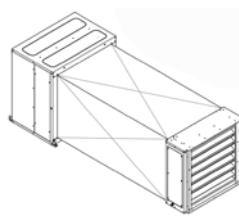

En conducto de aspiración

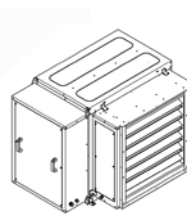

Junto a unidad de ventilación

Se pueden usar 2 dampers instalando dos puntos de aspiración alejados del ventilador, de forma que siempre uno de los puntos estará en posición abierta y el otro cerrado. En caso de detección de humos en la boca de aspiración con damper abierto, éste se cerrará y se abrirá el segundo damper para asegurar la entrada de aire limpio al espacio a proteger (vía de escape libre de humo)

HATCH PDS

Equipos de presurización para escaleras, rutas de escape y vestíbulos de conformidad a la norma europea EN 12101-6

Equipos de presurización de vías de escape en caso de incendio cumpliendo requisitos de la norma europea EN 12101-6. El HATCH PDS regula de forma automática el flujo de aire y es capaz de mantener los 50 Pa de sobrepresión aún con presencia de fugas en la instalación. El sistema es capaz de mantener la sobrepresión (Pressure criteria) y una velocidad de 0,75 m/s en caso de puerta abierta (Airflow criteria) de forma casi inmediata.

HATCH PDS

Consta de una unidad de ventilación HATCH-S con apertura de compuerta motorizada y de un cuadro de control BOXPDS

- Estructura de gran robustez para aguantar severos cambios climáticos.
- Estructura del equipo en chapa galvanizada anticorrosiva.
- Diseño para asegurar la estanqueidad a la entrada del agua.
- Aislamiento térmico para evitar pérdidas de aire caliente en invierno.
- Zócalo de adaptación para la correcta y fácil instalación en el tejado.

Sistema de apertura:

- Brazos motorizados de apertura, con mecanismo encapsulado IP-65.
- Tensión de alimentación 230 V. AC 60Hz o 24V. DC.
- Sistema reforzado y garantizado con más de 10.000 operaciones en carga máxima.
- Carga máxima 1000 Nw.
- Apertura automática mediante señal externa del sistema de control (central de incendios, detector de humos, interruptor manual...)
- Sistemas de control no incluidos en el suministro.
- Apertura manual para ventilación ambiental mediante interruptor.
- Interruptor final de carrera para señalar la posición de la compuerta.

Ventilador:

- Extractores serie HCT.
- Envoltente tubular en chapa de acero con tratamiento anticorrosivo en resina de poliéster.
- Hélices en fundición de aluminio.

Motor:

- Motores de eficiencia IE3 para potencias iguales o superiores a 0,75kW, excepto monofásicos, 2 velocidades y 8 polos.
- Motores clase F, con rodamientos a bolas, protección IP55.
- Motor Multitensión, diseño especial válido para: 220/380V 60Hz, 254/440V 60Hz, 265/460V 60Hz, 277/480V 60Hz
- Temperatura de trabajo : -25°C +50°C

Acabado:

- Anticorrosivo en chapa de acero galvanizado

Bajo demanda:

- Equipados con ventiladores certificados F-300 y F-400
- Equipos de presurización reversibles para evacuación de humos en caso de necesidad.
- Acabado con pintura anticorrosiva en resina de poliéster.

BOXPDS

- Variador de frecuencia Inverter.
- Sonda de diferencial de presión de gran precisión.
- Cuadro eléctrico con protecciones magnetotérmicas con indicación de fallo en la alimentación general.
- Control electrónico para gestión de alarmas, mantenimiento, puerto ModBUS RTU para conexión a sistemas BMS (Building management systems) y control por DAMPER.
- Fuente de alimentación certificada, con baterías para asegurar el correcto funcionamiento de los equipos de control en caso de fallo en la red eléctrica.

Cuadro de mandos:

- Cuadro de mandos externo para la visualización de la presión a tiempo real, pilotos de alarmas y activación manual del sistema.



+50 Pa

Código de pedido

HATCH PDS	— 80	— 4T	—	5.5	— N	—	1	—	G	— 60Hz
Modelo	Tamaño	Número de polos motor 2=3500 r/min. 60 Hz 4=1680 r/min. 60 Hz 6=1080 r/min. 60 Hz	T=Trifásico	Potencia motor (c.v.)	Accesorios eléctricos N= sin accesorios Y= interruptor final de carrera	Tensión de alimentación sistema de apertura 1=230 V.AC 2=24 V.DC	Acabado G=galvanizado P=pintado color especial			

60Hz

Características técnicas

Modelo	Velocidad (r/min)	Intensidad máxima admisible (A)		Potencia instalada (kW)	Caudal máximo (m3/h)	Nivel presión sonora dB(A)	Peso aprox. (Kg)
		220-277V	380-480V				
HATCH PDS-40-2T-1	3420	3,15	1,80	0,75	6115	76,60	184
HATCH PDS-40-2T-1,5	3456	4,70	2,70	1,10	7050	76,65	188
HATCH PDS-45-2T-2	3456	5,90	3,40	1,50	9405	78,75	193
HATCH PDS-45-2T-3	3408	8,70	5,00	2,20	11325	80,85	194
HATCH PDS-50-2T-2	3456	5,90	3,40	1,50	10100	80,85	197
HATCH PDS-50-2T-3	3408	8,70	5,00	2,20	11925	81,90	199
HATCH PDS-50-2T-4	3456	11,20	6,50	3,00	13860	82,95	206
HATCH PDS-50-2T-5,5	3444		9,30	4,00	15900	84,00	222
HATCH PDS-56-2T-5,5	3444		9,50	4,00	18840	89,25	226
HATCH PDS-56-2T-7,5	3492		10,60	5,50	22510	90,30	237
HATCH PDS-56-4T-2	1728	6,20	3,60	1,50	15020	75,60	205
HATCH PDS-63-4T-3	1710	9,00	5,20	2,20	22460	76,65	262
HATCH PDS-63-4T-4	1716	11,40	6,60	3,00	24460	77,70	271
HATCH PDS-63-6T-1	1128	4,70	2,70	0,75	16025	66,15	252
HATCH PDS-80-4T-3	1710	9,00	5,20	2,20	25545	82,95	280
HATCH PDS-80-4T-4	1716	11,40	6,60	3,00	30410	84,00	289
HATCH PDS-80-4T-5,5	1728		8,40	4,00	32940	85,05	295
HATCH PDS-80-4T-7,5	1752		12,60	5,50	39820	86,10	311
HATCH PDS-80-6T-1,5	1134	5,50	3,20	1,10	21580	72,45	279
HATCH PDS-80-6T-2	1134	7,40	4,30	1,50	26090	73,50	288
HATCH PDS-90-4T-7,5	1752		12,60	5,50	46325	92,40	392
HATCH PDS-90-4T-10	1752		17,70	7,50	50315	93,45	403
HATCH PDS-90-4T-15	1752		22,00	11,00	59610	94,50	456
HATCH PDS-90-6T-3	1140	9,50	5,50	2,20	34055	78,75	365
HATCH PDS-90-6T-4	1164	13,50	7,80	3,00	39055	79,80	391
HATCH PDS-100-4T-10	1752		17,70	7,50	57650	94,50	413
HATCH PDS-100-4T-15	1752		22,00	11,00	66505	95,55	466
HATCH PDS-100-6T-5,5	1164		11,00	4,00	47955	85,05	413
HATCH PDS-100-6T-7,5	1164		12,40	5,50	53545	86,10	420

Características técnicas del exutorio dinámico según norma EN 12101-3:2002/AC:2006

Modelo	Homologación °C	Clase aislamiento motor	Durabilidad	Temperatura ambiente mínima	Carga de viento (Pa)	Carga de nieve (Pa)
HATCH PDS	-	Clase F	RE 10000	T(-15)	WL 1500	SL 500

Características acústicas

Los valores indicados se determinan mediante medidas de potencia sonora en dB(A) obtenidas en campo libre a una distancia equivalente a dos veces la envergadura del ventilador más el diámetro de la hélice, con un mínimo de 1,5 mts.

Espectro de potencia sonora Lw(A) en dB(A) por banda de frecuencia en Hz.

Modelo	63	125	250	500	1000	2000	4000	8000	Modelo	63	125	250	500	1000	2000	4000	8000
40-2-1	44	65	72	77	80	76	69	58	80-4-4	54	74	82	87	89	86	79	71
40-2-1,5	45	66	73	78	81	77	70	59	80-4-5,5	54	74	82	87	89	86	79	72
45-2-2	47	68	75	80	83	79	72	61	80-4-7,5	55	75	83	88	90	87	80	73
45-2-3	49	70	77	82	85	81	74	63	80-6-1,5	47	64	72	77	79	76	69	58
50-2-2	52	72	80	85	87	84	77	66	80-6-2	48	65	73	78	80	77	70	59
50-2-3	53	73	81	86	88	85	78	67	90-4-7,5	57	78	85	90	93	89	82	71
50-2-4	54	74	82	87	89	86	79	68	90-4-10	56	77	84	89	92	88	81	70
50-2-5,5	55	75	83	88	90	87	80	69	90-4-15	58	79	86	91	94	90	83	72
56-2-5,5	60	80	88	93	95	92	85	74	90-6-3	54	68	75	80	83	79	72	61
56-2-7,5	61	81	89	94	96	93	86	75	90-6-4	55	70	77	82	85	81	74	63
56-4-2	47	67	75	80	82	79	72	61	100-4-10	60	80	88	93	95	92	85	74
63-4-3	50	68	76	81	83	80	75	64	100-4-15	59	79	87	92	94	91	84	73
63-4-4	51	69	77	82	84	81	76	65	100-4-20	61	81	89	94	96	93	86	75
63-6-1	41	60	68	73	75	72	65	55	100-6-5,5	62	71	79	84	86	83	76	65
80-4-3	56	75	83	89	90	87	81	70	100-6-7,5	63	72	80	85	87	84	77	66

Dimensiones mm

HATCH PDS

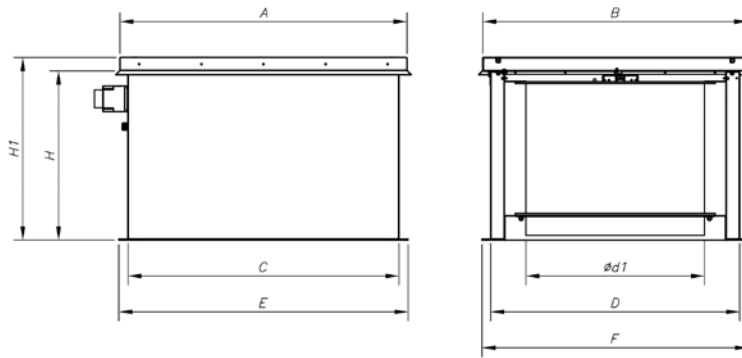

Modelo	A	B	C	D	ød1	E	F	H	H1	Modelo	A	B	C	D	ød1	E	F	H	H1
HATCH PDS-40-2T-1	1100	990	1022	920	400	1100	1000	760	820	HATCH PDS-80-4T-4	1295	1195	1222	1122	800	1300	1200	760	820
HATCH PDS-40-2T-1'5	1100	990	1022	920	400	1100	1000	760	820	HATCH PDS-80-4T-5'5	1295	1195	1222	1122	800	1300	1200	760	820
HATCH PDS-45-2T-2	1100	990	1022	920	450	1100	1000	760	820	HATCH PDS-80-4T-7'5	1295	1195	1222	1122	800	1300	1200	760	820
HATCH PDS-45-2T-3	1100	990	1022	920	450	1100	1000	760	820	HATCH PDS-80-6T-1'5	1295	1195	1222	1122	800	1300	1200	760	820
HATCH PDS-50-2T-2	1100	990	1022	920	500	1100	1000	760	820	HATCH PDS-80-6T-2	1295	1195	1222	1122	800	1300	1200	760	820
HATCH PDS-50-2T-3	1100	990	1022	920	500	1100	1000	760	820	HATCH PDS-90-4T-7'5	1492	1392	1420	1320	900	1500	1400	860	920
HATCH PDS-50-2T-4	1100	990	1022	920	500	1100	1000	760	820	HATCH PDS-90-4T-10	1492	1392	1420	1320	900	1500	1400	860	920
HATCH PDS-50-2T-5'5	1100	990	1022	920	500	1100	1000	760	820	HATCH PDS-90-4T-15	1492	1392	1420	1320	900	1500	1400	860	920
HATCH PDS-56-2T-5'5	1100	990	1022	920	560	1100	1000	760	820	HATCH PDS-90-6T-3	1492	1392	1420	1320	900	1500	1400	860	920
HATCH PDS-56-2T-7'5	1100	990	1022	920	560	1100	1000	760	820	HATCH PDS-90-6T-4	1492	1392	1420	1320	900	1500	1400	860	920
HATCH PDS-56-4T-2	1100	990	1022	920	560	1100	1000	760	820	HATCH PDS-100-4T-10	1492	1392	1420	1320	1000	1500	1400	860	920
HATCH PDS-63-4T-3	1295	1195	1222	1122	630	1300	1200	760	820	HATCH PDS-100-4T-15	1492	1392	1420	1320	1000	1500	1400	860	920
HATCH PDS-63-4T-4	1295	1195	1222	1122	630	1300	1200	760	820	HATCH PDS-100-4T-20	1492	1392	1420	1320	1000	1500	1400	860	920
HATCH PDS-63-6T-1	1295	1195	1222	1122	630	1300	1200	760	820	HATCH PDS-100-6T-5'5	1492	1392	1420	1320	1000	1500	1400	860	920
HATCH PDS-80-4T-3	1295	1195	1222	1122	800	1300	1200	760	820	HATCH PDS-100-6T-7'5	1492	1392	1420	1320	1000	1500	1400	860	920

BOXPDS

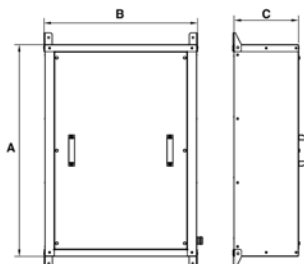

Modelo	A	B	C
BOXPDS	900	650	280

CERTIFICADO ATEX

EXTRACTORES ATMÓSFERAS EXPLOSIVAS ATEX



EAC



390

HCDF

Extractores helicoidales con marco cuadrado, con Certificación ATEX Ex d

397

HDF

Extractores helicoidales con marco circular, con Certificación ATEX Ex d

397

HCH/ATEX

Extractores helicoidales murales de gran robustez, con Certificación ATEX

400

HCT/ATEX

Extractores helicoidales tubulares de gran robustez, con Certificación ATEX

400

CMA/ATEX

Extractores centrífugos de media presión en fundición de aluminio, con certificación ATEX

404

CMP/ATEX

Extractores centrífugos de media presión equipados con turbina multipala, con certificación ATEX

406

CMR/ATEX

Extractores centrífugos de media presión y gran robustez, equipados con turbina a reacción, con certificación ATEX

410



ATMÓSFERAS EXPLOSIVAS ATEX

Todos los extractores y ventiladores SODECA para atmosferas explosivas cumplen con las exigencias de la directiva europea ATEX 94/9/CE y han estado diseñados de acuerdo a la norma EN-14986 "Diseño de ventiladores para trabajar en atmósferas potencialmente explosivas". De esta forma se garantiza la calidad de los productos y se asegura al máximo la seguridad de las personas e instalaciones.

CERTIFICADOS ATMÓSFERAS EXPLOSIVAS ATEX



EAC

Diseño de los ventiladores:

De acuerdo a la norma EN-14986 y para evitar la ignición en el caso de fricción o impacto entre la parte móvil y la estática, se fabrican con materiales combinables entre sí para prevenir posibles chispas.

Ventiladores centrífugos:

Para prevenir chispas generadas por la turbina:

- . Boca de aspiración de cobre
- . Casquillos de protección para proteger las uniones atornilladas/remachadas
- . Verificación de las distancias entre componentes

Ventiladores helicoidales:

- Para prevenir chispas generadas por la hélice:

- . Banda de recubrimiento de cobre o aluminio sobre la cara interior del aro
- . Verificación de las distancias entre componentes

Siguiendo la normativa, todas las partes del ventilador que no están soldadas entre sí, y están fijadas mecánicamente mediante otros sistemas, o son diferentes piezas recubiertas de pintura que pueden aislar la conductividad, están unidas mediante tomas de tierra, para evitar las diferencias de potencial entre estas partes no soldadas o pintadas.

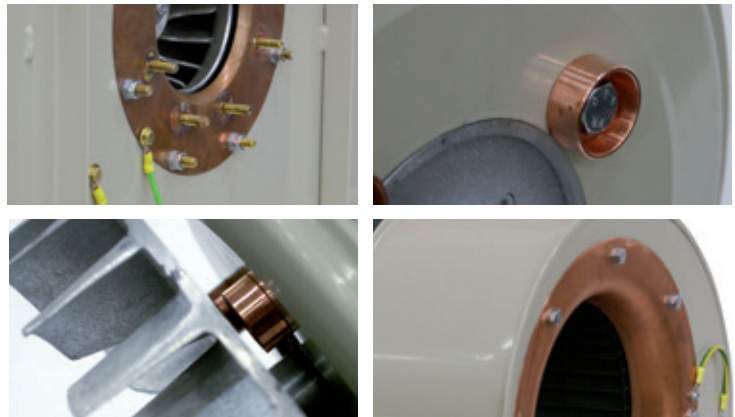

Sodeca se ha especializado desde sus orígenes en el diseño y la fabricación de ventiladores y sus accesorios para aplicaciones industriales.

La unión de la experiencia adquirida durante décadas de trabajo con ventiladores, junto con la tecnología aportada por ingenieros distribuidos en diferentes departamentos, ha permitido que Sodeca se sitúe entre los mayores fabricantes de ventilación industrial del mundo.

Las aplicaciones industriales requieren gran capacidad de adaptación a las especificaciones de cada proyecto y flexibilidad en la fabricación, para cumplir con las necesidades reales de cada cliente.

Para cumplir con este objetivo Sodeca dispone de una línea de productos Standard y una línea de productos de fabricación especial, para la construcción de ventiladores adaptados a las exigencias de nuestros clientes.

Para los diferentes proyectos podemos utilizar motores que cumplen las normativas más exigentes del mercado:

NEMA super premium efficiency

NEMA premium efficiency

NEMA high efficiency

U.L. motors

C.S.A. motors

CUMPLIMIENTO DE NORMAS

Los ventiladores y extractores de SODECA, cumplen con las siguientes normativas:

CALIDAD	
ISO 9001:2015	Sistemas de gestión de la calidad. Requisitos. Quality management systems -- Requirements
ENSAYOS	
ISO 5801	Ventiladores industriales. Ensayos de comportamiento en circuitos normalizados. Industrial fans -- Performance testing using standardized airways
AMCA 210-07	Ventiladores industriales. Métodos de ensayos de ventiladores y su representación de ensayos. Laboratory Methods of Testing Fans for Aerodynamic Performance Rating
UNE-EN ISO 5801	Ventiladores. Dispositivos e instalaciones para el ensayo de ventiladores.
UNE-EN ISO 13350	Ventiladores industriales. Ensayos de comportamiento de ventiladores de chorro. Industrial fans -- Performance testing of jet fans
ISO 13348	Industrial fans -- Tolerances, methods of conversion and technical data presentation
VENTILADORES PARA ALTA TEMPERATURA	
EN 12101-3	Sistemas de control de humos y calor. Parte 3: Especificaciones para aireadores extractores de humos y calor mecánicos. Smoke and heat control systems - Part 3: Specification for powered smoke and heat exhaust ventilators
ACÚSTICA	
ISO 3744	Acústica. Determinación de los niveles de potencia acústica de fuentes de ruido a partir de la presión acústica. Método de ingeniería para condiciones de campo libre sobre un plano reflectante. Acoustics -- Determination of sound power levels of noise sources using sound pressure -- Engineering method in an essentially free field over a reflecting plane
EQUILIBRADO Y VIBRACIONES	
ISO 1940-1	Vibraciones mecánicas. Calidad de equilibrado Mechanical vibration -- Balance quality requirements for rotors in a constant (rigid) state -- Part 1: Specification and verification of balance tolerances
ISO 10816-1	Vibraciones mecánicas. Evaluación de las vibraciones de máquinas Mechanical vibration -- Evaluation of machine vibration by measurements on non-rotating parts -- Part 1: General guidelines
ISO 14694	Ventiladores industriales. Especificaciones para equilibrado y niveles de vibración Industrial fans -- Specifications for balance quality and vibration levels
SEGURIDAD (Declaración de Conformidad CE)	
EN ISO 12100	Seguridad de las máquinas. Conceptos básicos, principios generales para el diseño. Parte 1: Terminología básica, metodología. Safety of machinery -- Basic concepts, general principles for design -- Part 1: Basic terminology, methodology
EN ISO 12100	Seguridad de las máquinas. Conceptos básicos, principios generales para el diseño. Parte 2: Principios técnicos. Safety of machinery -- Basic concepts, general principles for design -- Part 2: Technical principles
UNE EN 60204-1	Seguridad de las máquinas. Equipo eléctrico de las máquinas. Parte 1: Requisitos generales. Safety of machinery - Electrical equipment of machines - Part 1: General requirements
ISO 13857	Seguridad de máquinas. Distancias de seguridad para impedir que se alcancen zonas peligrosas con los miembros superiores e inferiores. Safety of machinery -- Safety distances to prevent danger zones being reached by upper and lower limbs
UNE-EN ISO 12499	Ventiladores industriales. Seguridad mecánica en los ventiladores Industrial fans -- Mechanical safety of fans -- Guarding
DIRECTIVAS Y REGLAMENTOS	
Directiva 2006/42/CE	Directiva de máquinas Machinery Directive
Directiva 2014/35/UE	Directiva de baja tensión Low Voltage Directive
Directiva 2014/30/UE	Directiva compatibilidad electromagnética EMC Directive
Reglamento 305/2011	Directiva productos de construcción Construction Products Directive (CPR)
Directiva 2009/125/CE	Directiva de requisitos de diseño ecológico para productos que utilizan energía. Ecodesign Requirements for Energy-related Products Directive

EJECUCIONES ATEX

Directiva ATEX 2014/34/UE	Aparatos y sistemas de protección para uso en atmósferas potencialmente explosivas Equipment and protective systems intended for use in potentially explosive atmospheres
EN 14986	Diseño de ventiladores para trabajar en atmósferas potencialmente explosivas. Design of fans working in potentially explosive atmospheres
EN 13463-1	Equipos no eléctricos destinados a atmósferas potencialmente explosivas. Parte 1: Requisitos y metodología básica. Non-electrical equipment for use in potentially explosive atmospheres - Part 1: Basic method and requirements
EN 1127-1	Atmósferas explosivas. Prevención y protección contra la explosión. Parte 1: Conceptos básicos y metodología. Explosive atmospheres - Explosion prevention and protection - Part 1: Basic concepts and methodology



Extractores para **ATMÓSFERAS EXPLOSIVAS ATEX**

Una zona ATEX es una mezcla de aire con **gas** inflamable, **vapor** de líquido inflamable, **niebla** de líquido combustible o **polvo** combustible, que de inflamarse lo hacen en todo su conjunto a la vez.



Sensibilidad a la inflamación de los gases:

LIE	Límite inferior de explosividad » % volumen.
LSE	Límite superior de explosividad » % volumen.
EMI	Energía mínima de Inflamación » 10-6 μ Joules
Flash Point	Temperatura mínima de un líquido forma gases inflamables
Temperatura de Ignición	Temperatura a la que inflama un gas (T1, T2, T3, T4, T5 y T6)

Sensibilidad a la inflamación de sólidos:

LIE ó CME	Concentración mínima explosiva » g/m ³
CLO	Concentración límite de Oxígeno » % volumen
EMI	Energía mínima de Inflamación » 10-3 μ Joules
TMI	Temperatura mínima de inflamación en °C: - En nube TMI n (nube de polvo en contacto con una superficie caliente). - En capa TMI c ignición de una capa de 5 mm. - (límite de T el menor de: 2/3 de TMI n o TMI c -75°C)

Resumen de definiciones de las zonas

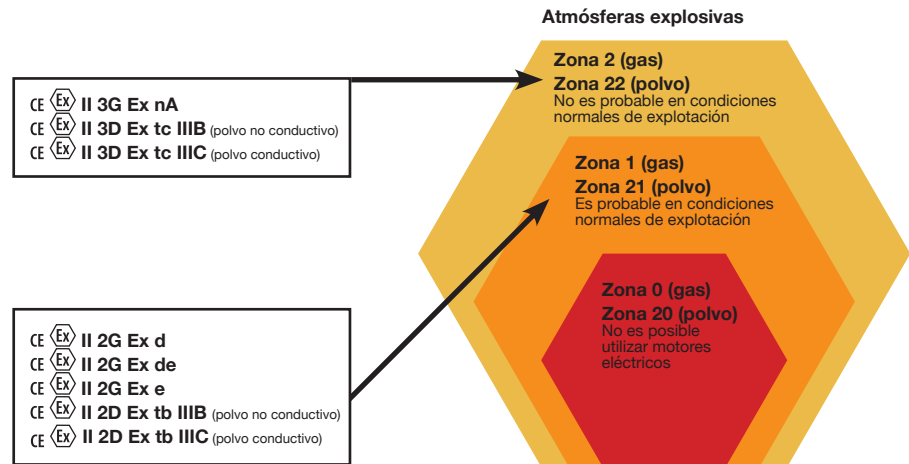

Definición de zonas:

Gases y vapores / Polvos:

- **Zona 0 / Zona 20:**
Presente continuamente, durante largos periodos de tiempo o frecuentemente. No es posible utilizar motores eléctricos.
- **Zona 1 / Zona 21:**
Es probable en condiciones normales de funcionamiento
- **Zona 2 / Zona 22:**
No es probable la creación de zona ATEX en condiciones de funcionamiento normal

Grupos y categorías de aparatos:

GRUPO I: equipos para trabajos subterráneos y de superficie de minas con peligro por grisú o polvos explosivos.

- Categoría M1: deben permanecer operativos
- Categoría M2: se debe poder cortar la alimentación de energía

GRUPO II: Otras zonas de riesgo

- Categoría 1: nivel de protección muy alto. Zona muy probable.
- Categoría 2: nivel de protección alto. Zona probable.
- Categoría 3: nivel de protección normal. Zona poco probable.

Selección de la categoría en función de la zona:

ZONA	CATEGORÍA
0 o 20	1
1 o 21	1 o 2
2 o 22	1, 2 o 3

Selección de zona en función de la categoría:

CATEGORÍA	ZONA
1	Todas
2	1, 21, 2 o 22
3	2 o 22

Grupo de explosión y clase de temperatura

Grupo de explosión	Clase de temperatura					
	T1	T2	T3	T4	T5	T6
II A	Acetona Etano Acetato etílico Cloruro de etilo Amoníaco Benceno Ácido acético	Óxido de carbono Metano Metanol Cloruro de metilo Propano Gas ciudad Tolueno	Acetato amílico-i Butano Alcohol butílico-n Ciclo-hexano Dicloroetano 1, 2 Anhídrido acético	Gasolina Carburantes Otto Carburante aviación Aceites combustib. Hexano	Acetal-dehido	
II B		Alcohol etílico Etileno Óxido de etileno	Hidrógeno sufarado	Eter etílico		
II C	Hidrógeno	Acetileno				Sulfuro de carbono

Clase de temperatura y temperatura de ignición:

Clase de temperatura	Temperatura de ignición
T1	>450°C
T2	>300°C
T3	>200°C
T4	>135°C
T5	>100°C
T6	>85°C

Valores de explosividad de sólidos combustibles

Producto	Kmax	Pmax	EMI	CLO	TMIn	TIMc
Harina de maíz	127	6.7	300	--	530	460
Harina de arroz	40	6.7	>10	--	370	480
Harina de trigo	47	8.2	>300	11%	460	470
Harina de Malta	100	7.8	>10	11%	310	460
Almidón de maíz	143	10.6	>100	9%	440	400
Almidón de arroz	220	10.0	>10	--	470	390
Almidón de patata	89	9.4	>3000	--	520	570

Marcado según ATEX

Marcado de motores de acuerdo con la directiva ATEX

CE	0081	Ex	II	2	G/D
Marcado CE	Identificación del organismo certificador (Ej. LCIE)	Marcado CE para los productos Ex	Agrupamiento de aparatos eléctricos	Categoría del equipo (2 ó 3)	Gas o Polvo

Marcado según EN

Marcado estándar adicional para motores

Ex	d	II	C	T4	Gb
Aparato protegido contra explosiones	Tipo de protección	Grupos (todos excepto minas)	Grupos según Gas (necesario sólo para antideflagrantes)	Clase de temperatura	Nivel de protección contra explosión



Valores de explosividad de gases combustibles

	Grupo de gas	%vol LIE	g/mol M		Grupo de gas	%vol LIE	g/mol M
metano	I	5,0	16,04	cloroetano	IIA	3,6	64,51
acetato de amilo	IIA	1,1	130,19	cloroetano	IIIA	5,0	106,97
acetato de butilo	IIA	1,2	116,16	cloroetileno(cloruro de vinilo)	IIA	3,8	62,50
acetato de etilo	IIA	2,1	88,11	clorometano	IIA	7,6	50,49
acetato de metilo	IIA	3,1	74,08	cloropropano	IIA	2,6	78,54
acetato de propilo	IIA	1,7	102,13	cloruro de acetilo	IIA	5,0	78,50
acetona	IIA	2,2	55,06	cloruro de alilo	IIA	3,3	76,53
acetonitrilo	IIA	3,0	41,05	creso	IIIA	1,0	108,14
ácido acético	IIA	4,0	60,05	decahidronaftaleno(decalina)	IIA	0,7	138,25
aldehído acético	IIA	4,0	44,05	decano	IIA	0,81	42,28
amoníaco	IIA	15,0	17,03	diacetona-alcoho	IIIA	1,8	116,16
anilina	IIA	1,2	107,13	dicloroetano	IIA	5,6	98,96
benceno	IIA	1,2	78,11	dicloroetileno	IIA	6,5	96,94
bromobutano	IIA	2,6	137,02	dicloropropano	IIA	3,4	112,99
bromoetano	IIA	6,7	108,97	dietilamina	IIA	1,7	73,14
butano	IIA	1,5	58,12	dimetilamina	IIA	2,8	45,08
butano	IIIA	1,4	74,12	dimetilnilina	IIA	1,2	121,18
butil metil cetona	IIA	1,2	100,16	dipropiléter	IIA		102,18
butilamina	IIA	1,7	73,14	estireno	IIA	1,1	104,15
ciclobutano	IIA	1,8	56,11	etano	IIA	3,0	30,07
ciclohexano	IIA	1,2	84,16	etano	IIIA	3,3	46,07
ciclohexano	IIIA	1,2	100,16	etil metil cetona	IIA	1,8	72,11
ciclohexanona	IIA	1,3	98,14	etilbenceno	IIA	1,0	106,17
ciclopentano	IIA	1,1	70,13	etilmercaptano	IIA	2,8	62,13
clorobenceno	IIA	1,1	112,56	feno	IIIA	1,3	94,11
clorobutano	IIA	1,8	92,57	formiato de etilo	IIA	2,7	74,08



APLICACIONES
INDUSTRIALES



APLICACIONES
ATMÓSFERAS
EXPLOSIVAS ATEX



APLICACIONES
NAVALES

Valores de explosividad de gases combustibles

	Grupo de gas	%vol LIE	g/mol M		Grupo de gas	%vol LIE	g/mol M
formiato de metilo	IIA	5	60,05	trimetilamina	IIA	2,0	59,11
gasolina		0,7	73,95	xileno	IIA	1,0	106,17
heptano	IIA	1,1	100,20	1,2-epoxipropano (óxido de propileno)	IIB	1,9	58,08
hexano	IIA	1,2	86,18	1,3,5-trioxano	IIB	3,6	90,08
hexano	IIIA	1,2	102,18	1,3-butadieno	IIB	1,4	54,09
keroseno	IIA	0,7	87,00	1,4-dioxano	IIB	1,9	88,11
metilamina	IIA	4,9	31,06	ácido cianhídrico	IIB	46,5	27,03
metilciclohexano	IIA	1,1	98,19	acrilato de etilo	IIB	1,7	100,12
monóxido de carbono	IIA	12,5	28,01	acrilato de metilo	IIB	2,4	86,09
naftaleno	IIA	0,9	128,17	acrilonitrilo	IIB	2,8	53,06
nitroetano	IIA	4,0	75,07	alcohol tetrahidrofurfúrico	IIB	1,5	102,13
nitrometano	IIA	7,1	61,04	ciclopropano	IIB	2,4	42,08
nonano	IIA	0,7	128,26	éter dibutílico	IIB	0,9	130,23
nonano	IIIA	8,0	144,26	éter dietílico	IIB	1,9	74,12
octano	IIA	6,0	114,23	etil metil éter	IIB	2,0	60,10
pentano	IIA	1,4	72,15	etileno	IIB	2,7	28,05
pentano	IIIA	1,2	88,15	furano	IIB	2,3	68,08
petróleo	IIA	1,0	87,00	gas de coquería	IIB	5,0	
piridina	IIA	1,7	79,10	metilacetileno (propino)	IIB	1,7	40,06
propano	IIA	2,0	44,10	nitrato de isopropilo	IIB	2,0	105,09
propano	IIIA	2,1	60,10	óxido de etileno (epoxietano)	IIB	2,6	44,05
propeno (propileno)	IIA	2,0	42,08	tetrahidrofurano	IIB	1,5	72,11
propilamina	IIA	2,0	59,11	acetileno	IIC	1,5	26,04
tolueno	IIA	1,2	92,14	disulfuro de carbono	IIC	1,0	76,13
trietilamina	IIA	1,2	53,15	hidrógeno	IIC	4,0	2,02



**APLICACIONES
OFF-SHORE**



**APLICACIONES
INDUSTRIA QUÍMICA**

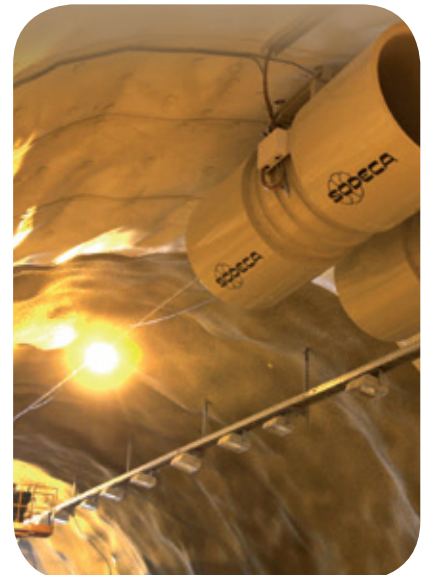

**APLICACIONES
MINERÍA Y OBRAS
PUBLICAS**

HCDF HDF



HCDF: Extractores helicoidales con marco cuadrado, con Certificación ATEX Ex d

HDF: Extractores helicoidales con marco circular, con Certificación ATEX Ex d



HCDF



HDF

Extractores helicoidales murales (HCDF) o circulares (HDF) con Certificación ATEX y motor antideflagrante CEE ExII2G Ex d, para trabajar en atmósferas explosivas.

Ventilador:

- Hélice en fundición de aluminio
- Dirección aire motor-hélice
- Prensaestopas antideflagrante incluido
- HCDF: Marco soporte en chapa de acero, con banda de aluminio en la zona de la hélice según norma EN-14986
- HCDF: Rejilla de protección contra contactos según norma UNE-EN ISO 12499
- HDF: Aro soporte en chapa de acero, con banda de aluminio en la zona de la hélice según norma EN-14986

Motor:

- Motores clase F, con rodamientos a bolas, protección IP55, con certificación ATEX, antideflagrantes Ex"d" IIBT4
- Motor Multitensión, diseño especial válido para: 220/380V 60Hz, 254/440V 60Hz, 265/460V 60Hz, 277/480V 60Hz
- HDF: Temperatura de trabajo: -20°C.+ 40°C.
- HCDF: Temperatura de trabajo: -20°C +50 °C



Marcado: $\text{CE} \text{Ex} \text{II} 2\text{G} \text{Ex} \text{d}$
Organismo notificado: L.O.M.
Nº de identificación:
LOM3ATEX0157

Acabado:

- Anticorrosivo con pintura ATEX, libre de componentes férricos, en resina de poliéster polimerizada a 190 °C, previo desengrase con tratamiento nanotecnológico libre de fosfatos

Bajo demanda:

- Bobinados especiales para diferentes tensiones y frecuencias
- Construcción ATEX para diferentes categorías
- Extractores con motor de 2 velocidades



Banda de aluminio para prevenir chispas según norma EN-14986:2006

Código de pedido

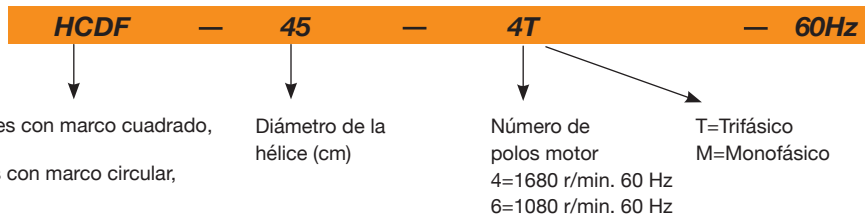

HCDF: Extractores helicoidales con marco cuadrado, con Certificación ATEX
HDF: Extractores helicoidales con marco circular, con Certificación ATEX

Diámetro de la hélice (cm)

Número de polos motor
4=1680 r/min. 60 Hz
6=1080 r/min. 60 Hz

T=Trifásico
M=Monofásico

Marcado: $\text{CE} \text{Ex} \text{II} 2\text{G} \text{c}$

60Hz

Características técnicas

Modelo	Velocidad (r/min)	Intensidad máxima admisible (A)		Potencia instalada (kW)	Caudal máximo (m³/h)	Nivel presión sonora dB(A)	Peso aprox. (Kg)
		220-277V	380-480V				
HCDF-25-4T	1644	0,78	0,45	0,09	890	51	6,5
HCDF-25-4M	1692	0,72		0,06	890	51	6,5
HCDF-31-4T	1644	0,78	0,45	0,09	1700	54	7,5
HCDF-31-4M	1692	0,72		0,06	1700	54	7,5
HCDF-35-4T	1644	0,78	0,45	0,09	2950	58	8,5
HCDF-35-4M	1692	0,72		0,06	2950	58	8,5
HCDF-40-4T	1704	1,3	0,75	0,25	4400	63	12,5
HCDF-40-4M	1680	3,25		0,25	4400	63	15
HCDF-45-4T	1704	1,3	0,75	0,25	6450	66	14,5
HCDF-45-4M	1680	3,25		0,25	6450	66	17
HCDF-45-6T	1110	0,95	0,55	0,12	5200	57	14,5
HCDF-50-4T	1668	1,73	1	0,37	8600	69	16,5
HCDF-50-6T	1104	1,56	0,9	0,18	6300	59	16
HCDF-56-4T	1668	3,08	1,78	0,55	10500	72	36,5
HCDF-56-6T	1092	1,59	0,92	0,25	8400	63	30,5
HDF-63-4T	1698	4,5	2,6	1,1	15100	76	49
HDF-63-6T	1086	2,37	1,37	0,37	12400	64	36,5
HDF-71-4T	1680	5,2	3	1,1	20000	79	52
HDF-71-6T	1080	3,29	1,9	0,55	13800	67	43
HDF-80-4T	1680	13,86	8	3	34100	83	76
HDF-80-6T	1092	5,89	3,4	1,1	20200	72	65,5
HDF-90-4T	1680	15,42	8,9	4	48200	89	87
HDF-90-6T	1104	7,45	4,3	1,5	30000	77	83

Características acústicas

Los valores indicados, se determinan mediante medidas de nivel de presión y potencia sonora en dB(A) obtenidas en campo libre a una distancia equivalente a dos veces la envergadura del ventilador más el diámetro de la hélice, con un mínimo de 1,5 mts.

Espectro de potencia sonora Lw(A) en dB(A) banda de frecuencia en [Hz]

Modelo	63	125	250	500	1000	2000	4000	8000	Modelo	63	125	250	500	1000	2000	4000	8000
25	22	37	56	55	56	55	50	41	63-4	52	66	85	85	86	84	80	71
31	25	40	59	58	59	58	53	44	63-6	40	54	73	73	74	72	68	59
35	29	44	63	62	63	62	57	48	71-4	56	76	84	89	91	88	81	70
40	34	49	68	67	68	67	62	53	71-6	44	64	72	77	79	76	69	58
45-4	37	52	71	70	71	70	65	56	80-4	60	80	88	93	95	92	85	74
45-6	28	43	62	61	62	61	56	47	80-6	49	69	77	82	84	81	74	63
50-4	43	57	76	76	77	75	71	62	90-4	67	88	95	100	103	99	92	81
56-4	46	60	79	79	80	78	74	65	90-6	55	76	83	88	91	87	80	69
56-6	37	51	70	70	71	69	65	56									

Dimensiones mm

HCDF 25...50

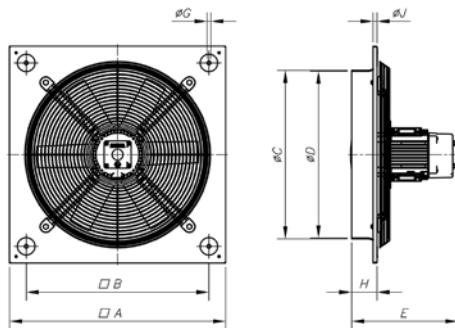

HCDF 56

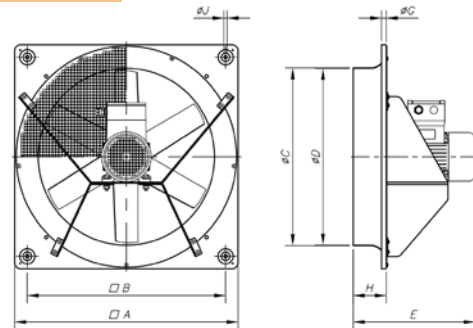

Modelo	A	B	ØC	ØD	E	G	H	ØI	ØJ
HCDF-25-4T	330	275	262	260	275	11	56	110	8,5
HCDF-25-4M	330	275	262	260	275	11	56	110	8,5
HCDF-31-4T	400	336	310,5	308	285	11	65	110	10,5
HCDF-31-4M	400	336	310,5	308	285	11	65	110	10,5
HCDF-35-4T	465	390	362,5	360	296	11	76	110	10,5
HCDF-35-4M	465	390	362,5	360	296	11	76	110	10,5
HCDF-40-4T	532	452	412,5	410	335	11	98	136	10,5
HCDF-40-4M	532	452	412,5	410	335	11	98	136	10,5
HCDF-45-4T	596	504	462,5	460	331	11	105	136	10,5
HCDF-45-4M	596	504	462,5	460	331	11	105	136	10,5
HCDF-45-6T	596	504	462,5	460	338	11	105	136	10,5
HCDF-50-4T	665	562	516,5	514	345	11	115	136	10,5
HCDF-56-4T	710	630	563	560	397	15	115	-	10,5
HCDF-56-6T	710	630	563	560	386	15	115	-	10,5

HDF

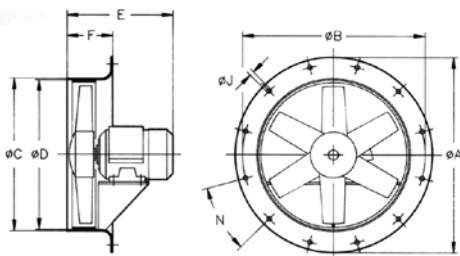

Modelo	ØA	ØB	ØC	D	E	F	ØJ	N
HDF-63-4T	730	690	645	640	370	150	12	12x30°
HDF-63-6T	730	690	645	640	330	150	12	12x30°
HDF-71-4T	810	770	715	710	349	150	12	16x22°30'
HDF-71-6T	810	770	715	710	323	150	12	16x22°30'
HDF-80-4T	900	860	805	800	421	180	12	16x22°30'
HDF-80-6T	900	860	805	800	371	180	12	16x22°30'
HDF-90-4T	1015	970	906	900	457	180	15	16x22°30'
HDF-90-6T	1015	970	906	900	415	180	15	16x22°30'

Curvas características

Q= Caudal en m³/h, m³/s y cfm.

Pe= Presión estática en mmH₂O, Pa e inwg.

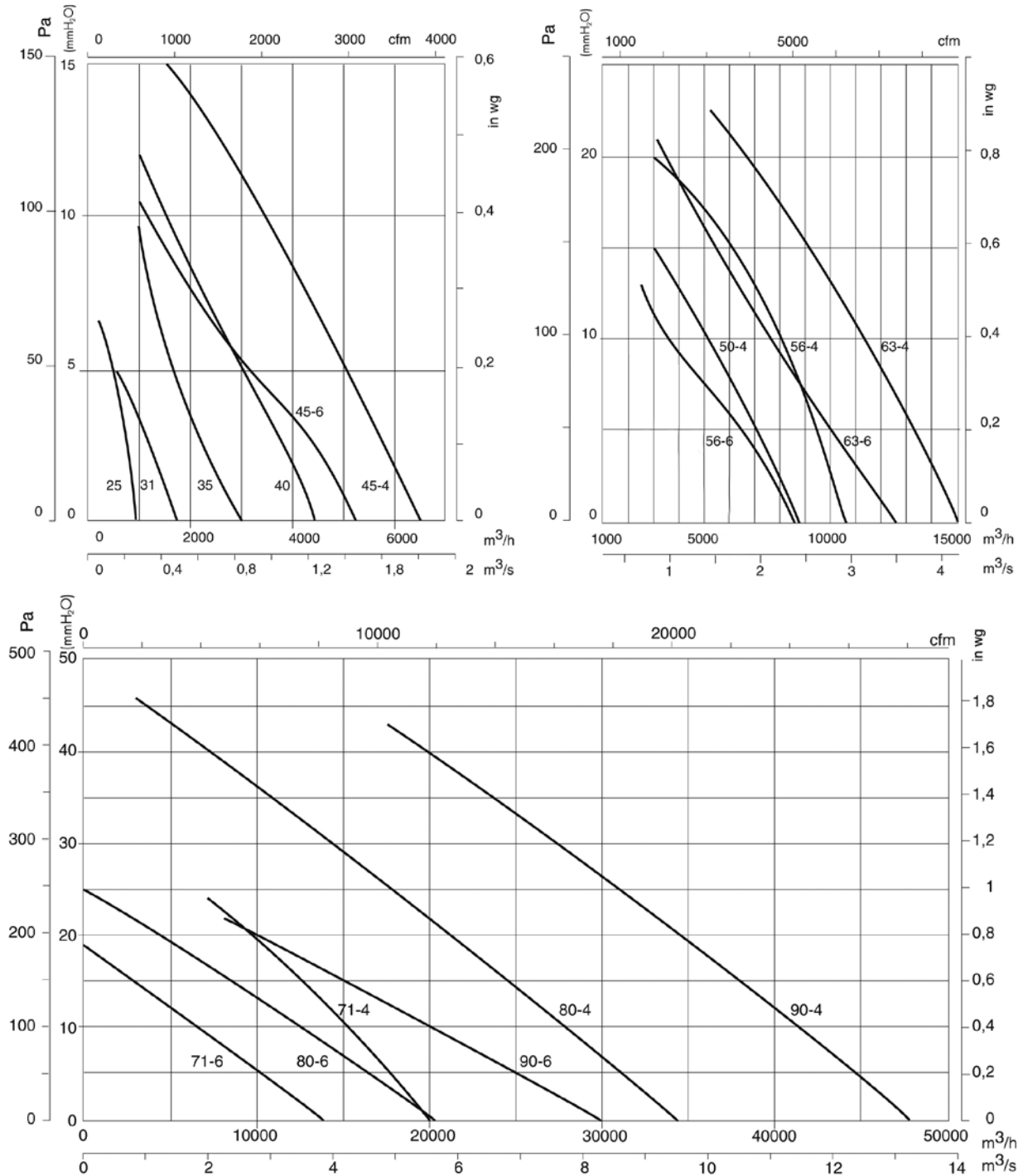

Accesorios



INT

VSD3/A-RFT
VSD1/A-RFM

CUADROS

P

R

RI

S

HCH/ATEX

HCT/ATEX



HCH/ATEX



HCT/ATEX

HCH/ATEX: Extractores helicoidales murales de gran robustez, con Certificación ATEX

HCT/ATEX: Extractores helicoidales tubulares de gran robustez, con Certificación ATEX

Extractores helicoidales circulares (HCH) o tubulares (HCT), y Certificación ATEX con motor antiexplosivo CEE ExII2G Ex e, antideflagrante CEE ExII2G Ex d, Ex tc, o Ex tb para trabajar en atmósferas explosivas

Ventilador:

- HCH/ATEX: Aro soporte en chapa de acero, con banda de aluminio en la zona de la hélice según norma EN-14986
- HCT/ATEX: Envolvente tubular en chapa de acero, con banda de aluminio en la zona de la hélice según norma EN-14986
- Hélice en fundición de aluminio
- Incorpora trampilla de inspección (HCT)
- Dirección aire motor-hélice

Motor:

- Motores clase F, con rodamientos a bolas con certificación ATEX, antiexplosivos Ex e, antideflagrante Ex d, Ex tc, o Ex tb
- Motor Multitensión, diseño especial válido para: 220/380V 60Hz, 254/440V 60Hz, 265/460V 60Hz, 277/480V 60Hz
- Temperatura de trabajo: -20°C.+ 40°C.

Acabado:

- Anticorrosivo con pintura ATEX, libre de componentes férricos, en resina de poliéster polimerizada a 190 °C, previo desengrase con tratamiento nanotecnológico libre de fosfatos

Bajo demanda:

- Motores con PTC incorporada
- Bobinados especiales para diferentes tensiones y frecuencias
- Construcción ATEX para diferentes categorías
- Extractores con motor de 2 velocidades
- Motores monofásicos antideflagrantes Ex d



Ex "e" marcado: CEE Ex II 2G Ex e
 Ex "d" marcado: CEE Ex II 2G Ex d
 Ex tc marcado: CEE Ex II 3D Ex tc
 Ex tb marcado: CEE Ex II 2D Ex tb
 Organismo notificado: L.O.M.
 N° de identificación:
 LOM3ATEX0157

Código de pedido

HCT/ATEX — **56** — **4T** — **1,5** — **Ex-e** — **60Hz**

HCH: Extractores helicoidales murales
 HCT: Extractores helicoidales tubulares

Diámetro de la hélice (cm)

Número de polos motor
 2=3500 r/min. 60 Hz
 4=1680 r/min. 60 Hz
 6=1080 r/min. 60 Hz

T=Trifásico

Potencia motor (c.v)

Ex-e: marcado: CEE Ex II 2G Ex e IIB T3
 Ex "d" marcado: CEE Ex II 2G Ex d IIB T5
 Ex tc marcado: CEE Ex II 3D Ex tc
 Ex tb marcado: CEE Ex II 2D Ex tb

Marcado:

CEE Ex II 2G c
 CEE Ex II 2D c
 CEE Ex II 3D c

Características técnicas

Modelo	Velocidad (r/min)	Intensidad máxima admisible (A)		Potencia instalada (kW)	Caudal máximo (m³/h)	Nivel presión sonora dB(A)	Peso aprox. con motor (Kg)	
		220-277V	380-480V				Ex-e	Ex-d
HCH/ATEX HCT/ATEX 35-2T	3360	2,08	1,20	0,37	5750	77	13	23
HCH/ATEX HCT/ATEX 35-4T	1728	1,28	0,74	0,12	3100	59	12	19
HCH/ATEX HCT/ATEX 40-2T-1,5	3480	4,50	2,60	1,1	8750	84	27	40
HCH/ATEX HCT/ATEX 40-4T-0,33	1740	2,08	1,20	0,25	5100	64	21	30
HCT/ATEX 45-2T-2	3480	6,24	3,60	1,5	10300	86	30	49
HCT/ATEX 45-2T-3	3480	8,66	5,00	2,2	12800	88	33	54
HCH/ATEX HCT/ATEX 45-4T-0,5	1740	2,60	1,50	0,37	7100	68	25	33
HCT/ATEX 50-4T-0,75	1740	2,94	1,70	0,55	10300	70	27	41
HCH/ATEX HCT/ATEX 56-4T-0,75	1740	2,94	1,70	0,55	11000	72	32	46
HCH/ATEX HCT/ATEX 56-4T-1	1740	3,81	2,20	0,75	12900	73	34	47
HCH/ATEX HCT/ATEX 56-4T-1,5	1740	5,20	3,00	1,1	14000	74	36	55
HCH/ATEX HCT/ATEX 56-4T-2	1740	6,93	4,00	1,5	15300	75	39	59
HCH/ATEX HCT/ATEX 56-6T-0,33	1140	2,42	1,40	0,25	8400	61	31	39
HCH/ATEX HCT/ATEX 56-6T-0,5	1140	2,77	1,60	0,37	9300	61	34	43
HCH/ATEX HCT/ATEX 56-6T-0,75	1140	3,46	2,00	0,55	10000	62	34	47
HCH/ATEX HCT/ATEX 63-4T-1	1740	3,81	2,20	0,75	14100	73	43	56
HCH/ATEX HCT/ATEX 63-4T-1,5	1740	5,20	3,00	1,1	17000	74	45	64
HCH/ATEX HCT/ATEX 63-4T-2	1740	6,93	4,00	1,5	18900	75	48	68
HCH/ATEX HCT/ATEX 63-4T-3	1740	9,01	5,20	2,2	22000	76	53	76
HCH/ATEX HCT/ATEX 63-4T-4	1740	12,30	7,10	3	25200	77	56	79
HCH/ATEX HCT/ATEX 63-6T-0,5	1140	2,77	1,60	0,37	12000	64	43	52
HCH/ATEX HCT/ATEX 63-6T-0,75	1140	3,46	2,00	0,55	12600	65	43	56
HCH/ATEX HCT/ATEX 63-6T-1	1140	4,16	2,40	0,75	13800	66	45	64
HCH/ATEX HCT/ATEX 71-4T-1,5	1740	5,20	3,00	1,1	19900	78	51	70
HCH/ATEX HCT/ATEX 71-4T-2	1740	6,93	4,00	1,5	21000	79	54	74
HCH/ATEX HCT/ATEX 71-4T-3	1740	9,01	5,20	2,2	24000	81	60	83
HCH/ATEX HCT/ATEX 71-4T-4	1740	12,30	7,10	3	29400	82	63	86
HCH/ATEX HCT/ATEX 71-6T-0,75	1140	3,46	2,00	0,55	15000	67	49	62
HCH/ATEX HCT/ATEX 71-6T-1	1140	4,16	2,40	0,75	17200	68	51	70
HCH/ATEX HCT/ATEX 71-6T-1,5	1140	5,89	3,40	1,1	21100	69	54	75
HCH/ATEX HCT/ATEX 80-4T-3	1740	9,01	5,20	2,2	29500	82	69	92
HCH/ATEX HCT/ATEX 80-4T-4	1740	12,30	7,10	3	37000	83	72	95
HCH/ATEX HCT/ATEX 80-4T-5,5	1740	15,76	9,10	4	40500	84	74	98
HCH/ATEX HCT/ATEX 80-6T-1	1140	4,16	2,40	0,75	23000	71	60	79
HCH/ATEX HCT/ATEX 80-6T-1,5	1140	5,89	3,40	1,1	26000	72	63	84
HCH/ATEX HCT/ATEX 80-6T-2	1140	7,62	4,40	1,5	29700	73	71	95
HCH/ATEX HCT/ATEX 80-6T-3	1140	9,35	5,40	2,2	33500	74	74	98
HCH/ATEX HCT/ATEX 90-4T-4	1740	12,30	7,10	3	40000	87	87	110
HCH/ATEX HCT/ATEX 90-4T-5,5	1740	15,76	9,10	4	46500	89	90	114
HCH/ATEX HCT/ATEX 90-4T-7,5	1740		12,00	5,5	51000	91	103	142
HCH/ATEX HCT/ATEX 90-4T-10	1140		16,30	7,5	54700	92	111	145
HCH/ATEX HCT/ATEX 90-6T-2	1140	7,62	4,40	1,5	34300	77	86	110
HCH/ATEX HCT/ATEX 90-6T-3	1140	9,35	5,40	2,2	38000	78	90	114
HCH/ATEX HCT/ATEX 90-6T-4	1740	14,72	8,50	3	42400	79	102	142
HCH/ATEX HCT/ATEX 100-4T-7,5	1740		12,00	5,5	54000	92	115	154
HCH/ATEX HCT/ATEX 100-4T-10	1740		16,30	7,5	63000	93	122	156
HCH/ATEX HCT/ATEX 100-4T-15	1740		23,80	11	68000	94	159	256
HCH/ATEX HCT/ATEX 100-4T-20	1140		30,60	15	72000	95	178	279
HCH/ATEX HCT/ATEX 100-6T-3	1140	9,35	5,40	2,2	43000	82	101	125
HCH/ATEX HCT/ATEX 100-6T-4	1140	14,72	8,50	3	47000	83	113	153
HCH/ATEX HCT/ATEX 100-6T-5,5	1740	18,88	10,90	4	53000	84	120	156

Dimensiones mm

HCH/ATEX

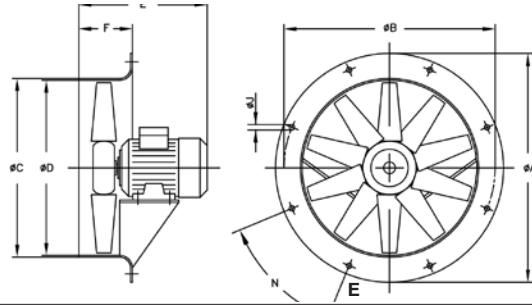

Modelo	ØA	ØB	ØC	ØD	0,16	0,33	0,5	0,75	1	1,5	2	3	4	5,5	7,5	10	15	20	F	ØJ	N
HCH-35-2	425	395	358	355	--	--	285	--	--	--	--	--	--	--	--	--	--	--	110	10	8x45°
HCH-35-4	425	395	358	355	257	--	--	--	--	--	--	--	--	--	--	--	--	--	110	10	8x45°
HCH-40-2	490	450	414	410	--	--	--	--	314	--	--	--	--	--	--	--	--	--	120	12	8x45°
HCH-40-4	490	450	414	410	--	305	--	--	--	--	--	--	--	--	--	--	--	--	120	12	8x45°
HCH-45-4	540	500	464	460	--	--	295	--	--	--	--	--	--	--	--	--	--	--	120	12	8x45°
HCH-45-6	540	500	464	460	--	295	--	--	--	--	--	--	--	--	--	--	--	--	120	12	8x45°
HCH-56-4	660	620	564	560	--	--	316	316	330	354	--	--	--	--	--	--	--	--	120	12	12x30°
HCH-56-6	660	620	564	560	--	298	316	316	--	--	--	--	--	--	--	--	--	--	120	12	12x30°
HCH-63-4	730	690	645	640	--	--	--	332	340	366	420	420	--	--	--	--	--	--	150	12	12x30°
HCH-63-6	730	690	645	640	--	--	332	332	340	--	--	--	--	--	--	--	--	--	150	12	12x30°
HCH-71-4	810	770	715	710	--	--	--	--	334	360	430	430	--	--	--	--	--	--	150	12	16x22°30'
HCH-71-6	810	770	715	710	--	--	--	323	334	360	--	--	--	--	--	--	--	--	150	12	16x22°30'
HCH-80-4	900	860	805	800	--	--	--	--	--	--	425	425	445	--	--	--	--	--	180	12	16x22°30'
HCH-80-6	900	860	805	800	--	--	--	--	360	386	425	445	--	--	--	--	--	--	180	12	16x22°30'
HCH-90-4	1015	970	906	900	--	--	--	--	--	--	--	436	430	465	465	--	--	--	180	12	16x22°30'
HCH-90-6	1015	970	906	900	--	--	--	--	--	436	430	465	--	--	--	--	--	--	180	12	16x22°30'
HCH-100-4	1115	1070	1006	1000	--	--	--	--	--	--	--	--	--	480	503	612	612	200	15	16x22°30'	
HCH-100-6	1115	1070	1006	1000	--	--	--	--	--	--	440	503	503	--	--	--	--	200	15	16x22°30'	

Las medidas corresponden a la versión Ex "e"

HCT/ATEX

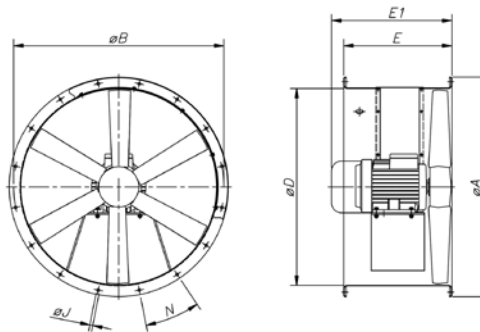

Modelo	ØA	ØB	D	E	E1	ØJ	N
HCT-35-2T/ATEX	425	395	355	280	306	10	8x45°
HCT-35-4T/ATEX	425	395	355	280	322	10	8x45°
HCT-40-2T-1,5/ATEX	490	450	410	400	400	12	8x45°
HCT-40-4T-0,33/ATEX	490	450	410	400	400	12	8x45°
HCT-45-2T-2/ATEX	540	500	460	400	422	12	8x45°
HCT-45-2T-3/ATEX	540	500	460	400	422	12	8x45°
HCT-45-4T-0,5/ATEX	540	500	460	400	400	12	8x45°
HCT-50-4T-0,75/ATEX	600	560	514	400	400	12	12x30°
HCT-56-4T-0,75/ATEX	660	620	560	400	400	12	12x30°
HCT-56-4T-1/ATEX	660	620	560	400	400	12	12x30°
HCT-56-4T-1,5/ATEX	660	620	560	400	422	12	12x30°
HCT-56-4T-2/ATEX	660	620	560	400	422	12	12x30°
HCT-56-6T-0,33/ATEX	660	620	560	400	400	12	12x30°
HCT-56-6T-0,5/ATEX	660	620	560	400	400	12	12x30°
HCT-56-6T-0,75/ATEX	660	620	560	400	400	12	12x30°
HCT-63-4T-1/ATEX	730	690	640	400	400	12	12x30°
HCT-63-4T-1,5/ATEX	730	690	640	400	422	12	12x30°
HCT-63-4T-2/ATEX	730	690	640	400	422	12	12x30°
HCT-63-4T-3/ATEX	730	690	640	500	500	12	12x30°
HCT-63-4T-4/ATEX	730	690	640	500	500	12	12x30°
HCT-63-6T-0,5/ATEX	730	690	640	400	400	12	12x30°
HCT-63-6T-0,75/ATEX	730	690	640	400	400	12	12x30°
HCT-63-6T-1/ATEX	730	690	640	400	422	12	12x30°
HCT-71-4T-1,5/ATEX	810	770	710	430	442	12	16x22°30'
HCT-71-4T-2/ATEX	810	770	710	430	442	12	16x22°30'
HCT-71-4T-3/ATEX	810	770	710	500	500	12	16x22°30'

Modelo	ØA	ØB	D	E	E1	ØJ	N
HCT-71-4T-4/ATEX	810	770	710	500	500	12	16x22°30'
HCT-71-6T-0,75/ATEX	810	770	710	430	430	12	16x22°30'
HCT-71-6T-1/ATEX	810	770	710	500	442	12	16x22°30'
HCT-71-6T-1,5/ATEX	810	770	710	500	442	12	16x22°30'
HCT-80-4T-3/ATEX	900	860	800	500	500	12	16x22°30'
HCT-80-4T-4/ATEX	900	860	800	500	500	12	16x22°30'
HCT-80-4T-5,5/ATEX	900	860	800	500	519	12	16x22°30'
HCT-80-6T-1/ATEX	900	860	800	500	500	12	16x22°30'
HCT-80-6T-1,5/ATEX	900	860	800	500	500	12	16x22°30'
HCT-80-6T-2/ATEX	900	860	800	500	500	12	16x22°30'
HCT-80-6T-3/ATEX	900	860	800	500	519	12	16x22°30'
HCT-90-4T-4/ATEX	1015	970	900	600	600	15	16x22°30'
HCT-90-4T-5,5/ATEX	1015	970	900	600	600	15	16x22°30'
HCT-90-4T-7,5/ATEX	1015	970	900	600	636	15	16x22°30'
HCT-90-4T-10/ATEX	1015	970	900	600	716	15	16x22°30'
HCT-90-6T-2/ATEX	1015	970	900	600	600	15	16x22°30'
HCT-90-6T-3/ATEX	1015	970	900	600	600	15	16x22°30'
HCT-90-6T-4/ATEX	1015	970	900	600	636	15	16x22°30'
HCT-100-4T-7,5/ATEX	1115	1070	1000	600	636	15	16x22°30'
HCT-100-4T-10/ATEX	1115	1070	1000	600	716	15	16x22°30'
HCT-100-4T-15/ATEX	1115	1070	1000	700	738	15	16x22°30'
HCT-100-4T-20/ATEX	1115	1070	1000	700	738	15	16x22°30'
HCT-100-6T-3/ATEX	1115	1070	1000	600	600	15	16x22°30'
HCT-100-6T-4/ATEX	1115	1070	1000	600	636	15	16x22°30'
HCT-100-6T-5,5/ATEX	1115	1070	1000	600	716	15	16x22°30'

Las medidas corresponden a la versión Ex "e"

Características acústicas

Los valores indicados, se determinan mediante medidas de nivel de presión y potencia sonora en dB(A) obtenidas en campo libre a una distancia equivalente a dos veces la envergadura del ventilador más el diámetro de la hélice, con un mínimo de 1,5 mts.

Espectro de potencia sonora Lw(A) en dB(A) banda de frecuencia en [Hz]

Modelo	63	125	250	500	1000	2000	4000	8000	Modelo	63	125	250	500	1000	2000	4000	8000	
35-2T	77	48	63	82	81	82	81	76	71-4T-4	82	59	79	87	92	94	91	84	73
35-4T	59	30	45	64	63	64	63	58	71-6T-0,75	67	44	64	72	77	79	76	69	58
40-2T-1,5	84	55	70	89	88	89	88	83	71-6T-1	68	45	65	73	78	80	77	70	59
40-4T-0,33	64	35	50	69	68	69	68	63	71-6T-1,5	69	46	66	74	79	81	78	71	60
45-2T-2	86	51	68	80	88	93	93	89	80-4T-3	82	59	79	87	92	94	91	84	73
45-2T-3	88	53	70	82	90	95	95	91	80-4T-4	83	60	80	88	93	95	92	85	74
45-4T-0,5	68	33	50	62	70	75	75	71	80-4T-5,5	84	61	81	89	94	96	93	86	75
50-4T-0,75	70	37	54	67	74	79	80	75	80-6T-1	71	48	68	76	81	83	80	73	62
56-4T-0,75	72	47	67	75	80	82	79	72	80-6T-1,5	72	49	69	77	82	84	81	74	63
56-4T-1	73	48	68	76	81	83	80	73	80-6T-2	73	50	70	78	83	85	82	75	64
56-4T-1,5	74	49	69	77	82	84	81	74	80-6T-3	74	51	71	79	84	86	83	76	65
56-4T-2	75	50	70	78	83	85	82	75	80-4T-4	87	65	86	93	98	101	97	90	79
56-6T-0,33	61	36	56	64	69	71	68	61	90-4T-5,5	89	67	88	95	100	103	99	92	81
56-6T-0,5	61	36	56	64	69	71	68	61	90-4T-7,5	91	69	90	97	102	105	101	94	83
56-6T-0,75	62	37	57	65	70	72	69	62	90-4T-10	92	70	91	98	103	106	102	95	84
63-4T-1	73	50	70	78	83	85	82	75	90-6T-2	77	55	76	83	88	91	87	80	69
63-4T-1,5	74	51	71	79	84	86	83	76	90-6T-3	78	56	77	84	89	92	88	81	70
63-4T-2	75	52	72	80	85	87	84	77	90-6T-4	79	57	78	85	90	93	89	82	71
63-4T-3	76	53	73	81	86	88	85	78	100-4T-7,5	92	72	92	100	105	107	104	97	86
63-4T-4	77	54	74	82	87	89	86	79	100-4T-10	93	73	93	101	106	108	105	98	87
63-6T-0,5	64	41	61	69	74	76	73	66	100-4T-15	94	74	94	102	107	109	106	99	88
63-6T-0,75	65	42	62	70	75	77	74	67	100-4T-20	95	75	95	103	108	110	107	100	89
63-6T-1	66	43	63	71	76	78	75	68	100-6T-3	82	62	82	90	95	97	94	87	76
71-4T-1,5	78	55	75	83	88	90	87	80	100-6T-4	83	63	83	91	96	98	95	88	77
71-4T-2	79	56	76	84	89	91	88	81	100-6T-5,5	84	64	84	92	97	99	96	89	78
71-4T-3	81	58	78	86	91	93	90	83										

Curvas características

Ver serie HCH y HCT

Accesorios



INT

VSD3/A-RFT
VSD1/A-RFM

CUADROS

P

R

RI

RT

BTUB

BAC

PS

S

CMA/ATEX



Extractores centrifugos de media presión en fundición de aluminio, con certificación ATEX

Extractores centrifugos de media presión y simple aspiración con envolvente y turbina en fundición de aluminio, para trabajar en atmósferas explosivas.

Ventilador:

- Envolvente en fundición de aluminio
- Turbina en fundición de aluminio

Motor:

- Motores clase F, con rodamientos a bolas, protección IP55, con certificación ATEX, antiexplosivos Ex"e" o antideflagrantes Ex"d"
- Motor Multitensión, diseño especial válido para: 220/380V 60Hz, 254/440V 60Hz, 265/460V 60Hz, 277/480V 60Hz
- Temperatura máxima del aire a transportar: -20°C. + 80°C.



Ex "e" marcado: C[Ⓒ]Ex II 2G Ex e
 Ex "d" marcado: C[Ⓒ]Ex II 2G Ex d
 Ex tc marcado: C[Ⓒ]Ex II 3D Ex tc
 Ex tb marcado: C[Ⓒ]Ex II 2D Ex tb
 Organismo notificado: L.O.M.
 N° de identificación:
 LOM04ATEX0007

Acabado:

- Anticorrosivo con pintura ATEX, libre de componentes férricos, en resina de poliéster polimerizada a 190 °C, previo desengrase con tratamiento nanotecnológico libre de fosfatos

Bajo demanda:

- Motores con PTC incorporada
- Bobinados especiales para diferentes tensiones y frecuencias
- Construcción ATEX para diferentes categorías

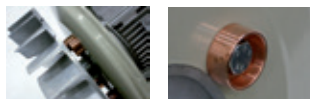

Código de pedido



Extractores centrifugos de media presión en fundición de aluminio, con certificación ATEX

Tamaño turbina

Número de polos motor
2=3500 r/min. 60 Hz

T=Trifásico

Potencia motor (c.v)

Ex-e: marcado:
C[Ⓒ]Ex II 2G Ex e IIB T3
 Ex "d" marcado:
C[Ⓒ]Ex II 2G Ex d IIB T5
 Ex tc marcado:
C[Ⓒ]Ex II 3D Ex tc
 Ex tb marcado:
C[Ⓒ]Ex II 2D Ex tb

Marcado:

C[Ⓒ]Ex II 2G c
 C[Ⓒ]Ex II 2D c
 C[Ⓒ]Ex II 3D c

60Hz

Características técnicas

Modelo	Velocidad (r/min)	Intensidad máxima (A)		Potencia instalada (kW)	Caudal máximo (m³/h)	Nivel presión sonora dB(A)	Peso aprox. con motor (Kg)	
		220-277V	380-480V				Ex-e	Ex-d
CMA-324-2T/ATEX	3420	1,21	0,70	0,18	440	70	10	16
CMA-325-2T/ATEX	3336	1,73	1,00	0,25	600	73	12	19
CMA-426-2T/ATEX	3318	2,08	1,20	0,37	850	75	14	24
CMA-527-2T/ATEX	3360	2,94	1,70	0,55	1000	80	17	25
CMA-528-2T-1/ATEX	3336	3,46	2,00	0,75	1250	82	24	36
CMA-528-2T-1,5/ATEX	3420	4,50	2,60	1,1	1750	83	27	40
CMA-531-2T-1,5/ATEX	3456	4,50	2,60	1,1	1790	84	30	43
CMA-531-2T-2/ATEX	3420	6,24	3,60	1,5	2000	85	31	50
CMA-540-2T/ATEX	3468	6,24	3,60	1,5	2600	85	38	57
CMA-545-2T-3/ATEX	3408	8,66	5,00	2,2	2630	86	54	75
CMA-545-2T-4/ATEX	3456	12,12	7,00	3	3550	88	63	87

Características acústicas

Los valores indicados, se determinan mediante medidas de nivel de presión y potencia sonora en dB(A) obtenidas en campo libre a una distancia equivalente a dos veces la envergadura del ventilador más el diámetro de la turbina, con un mínimo de 1,5 mts.

Espectro de potencia sonora Lw(A) en dB(A) banda de frecuencia en [Hz]

Modelo	Lp dB (A)	63	125	250	500	1000	2000	4000	8000	Modelo	Lp dB (A)	63	125	250	500	1000	2000	4000	8000
CMA-324-2T/ATEX	70	36	50	68	74	78	75	70	61	CMA-531-2T-1,5/ATEX	84	50	64	82	88	92	89	84	75
CMA-325-2T/ATEX	73	39	53	71	77	81	78	73	64	CMA-531-2T-2/ATEX	85	51	65	83	89	93	90	85	76
CMA-426-2T/ATEX	75	41	55	73	79	83	80	75	66	CMA-540-2T/ATEX	85	54	67	85	91	96	92	87	79
CMA-527-2T/ATEX	80	46	60	78	84	88	85	80	71	CMA-545-2T-3/ATEX	86	55	68	86	92	97	93	88	80
CMA-528-2T-1/ATEX	82	48	62	80	86	90	87	82	73	CMA-545-2T-4/ATEX	88	57	70	88	94	99	95	90	82
CMA-528-2T-1,5/ATEX	83	49	63	81	87	91	88	83	74										

Dimensiones mm

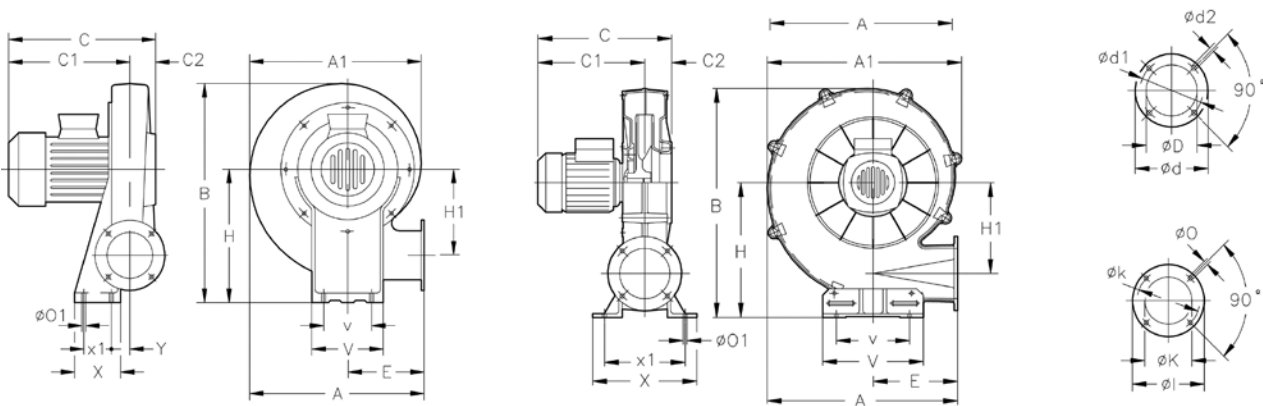

Modelo	Ex-"e"			Ex-"d"			C2	øD	ød	ød1	ød2	E	H	H1	øl	øK	øk	øO	øO1	V	v	X	x1	Y	
	A	A1	B	C	C1	C																			C1
CMA-324-2T/ATEX	311	302	356	263	225	288	250	38	80	130	112	M5	145	205	145	108	62	90	7	9	173	125	90	60	20
CMA-325-2T/ATEX	335	328	399	266	226	291	251	40	94	140	122	M6	155	235	152	120	80	102	7	9	180	145	110	80	20
CMA-426-2T/ATEX	354	344	412	293	253	316	276	40	117	155	132	M6	162	240	163	140	90	119	7	13	210	160	105	65	26
CMA-527-2T/ATEX	371	361	440	297	255	320	280	42	125	170	147	M6	168	260	170	155	100	129	7	13	220	170	120	80	20
CMA-528-2T-1/ATEX	401	395	488	340	292	342	294	51	116	190	162	M6	178	290	177	190	130	160	11	13	230	180	140	100	20
CMA-528-2T-1'5/ATEX	401	395	488	339	291	337	289	48	135	190	162	M6	178	290	177	190	130	160	11	13	230	180	140	100	20
CMA-531-2T-1'5/ATEX	440	434	537	340	292	342	294	50	160	215	180	M6	193	320	200	200	140	175	11	13	240	190	160	120	21
CMA-531-2T-2/ATEX	440	434	537	338	288	392	342	50	160	215	180	M6	193	320	200	200	140	175	11	13	240	190	160	120	21

Modelo	Ex-"e"			Ex-"d"			C2	øD	ød	ød1	ød2	E	H	H1	øl	øK	øk	øO	øO1	V	v	X	x1	Y	
	A	A1	B	C	C1	C																			C1
CMA-540-2T/ATEX	567	580	695	365	285	419	339	80	170	240	205	M10	252	415	270	220	150	190	13	11	336	218	374	240	-
CMA-545-2T-3/ATEX	651	646	776	438	323	467	352	115	180	255	220	M10	290	450	309	250	175	220	13	13	336	238	392	292	-
CMA-545-2T-4/ATEX	651	646	776	461	346	511	396	115	180	255	220	M10	290	450	309	250	175	220	13	13	336	238	392	292	-

Curvas características

Ver serie CMA

Accesorios



CMP/ATEX



Bajo demanda versión ATEX construcción en acero inoxidable

Extractores centrífugos de media presión equipados con turbina multipala, con certificación ATEX

Extractores centrífugos de media presión y simple aspiración con envolvente y turbina en chapa de acero, para trabajar en atmósferas explosivas.

Ventilador:

- Envolvente en chapa de acero
- Turbina con álabes hacia delante, en chapa de acero galvanizado
- Aro de aspiración antichispas en cobre o aluminio
- Temperatura máxima del aire a transportar: -20°C.+ 80°C.

Motor:

- Motores clase F, con rodamientos a bolas, protección IP55, con certificación ATEX, antiexplosivos Ex"e" o antideflagrantes Ex"d"
- Motor Multitensión, diseño especial válido para: 220/380V 60Hz, 254/440V 60Hz, 265/460V 60Hz, 277/480V 60Hz



Ex "e" marcado: C^{CE}Ex II 2G Ex e
 Ex "d" marcado: C^{CE}Ex II 2G Ex d
 Organismo notificado: L.O.M.
 Ex tc marcado: C^{CE}Ex II 3D Ex tc
 Ex tb marcado: C^{CE}Ex II 2D Ex tb
 N° de identificación:
 LOM04ATEX0007

Acabado:

- Anticorrosivo con pintura ATEX, libre de componentes férricos, en resina de poliéster polimerizada a 190 °C, previo desengrase con tratamiento nanotecnológico libre de fosfatos

Bajo demanda:

- Motores con PTC incorporada
- Bobinados especiales para diferentes tensiones y frecuencias
- Construcción ATEX para diferentes categorías
- Construcción en acero inoxidable

Código de pedido

CMP/ATEX — 1128 — 2T — 5,5 — Ex-e — 60Hz

Extractores centrífugos de media presión equipados con turbina multipala, con certificación ATEX

Tamaño turbina

Número de polos motor

2=3500 r/min. 60 Hz
 4=1680 r/min. 60 Hz

T=Trifásico

Potencia motor (c.v)

Ex-e: marcado: C^{CE}Ex II 2G Ex e IIB T3
 Ex "d" marcado: C^{CE}Ex II 2G Ex d IIB T5
 Ex tc marcado: C^{CE}Ex II 3D Ex tc
 Ex tb marcado: C^{CE}Ex II 2D Ex tb

Marcado:

C^{CE}Ex II 2G c
 C^{CE}Ex II 2D c
 C^{CE}Ex II 3D c

60Hz

Características técnicas

Modelo	Velocidad (r/min)	Intensidad máxima (A)		Potencia instalada (kW)	Caudal máximo (m³/h)	Nivel presión sonora dB(A)	Peso aprox. con motor (Kg)	
		220-277V	380-480V				Ex-e	Ex-d
CMP-616-2T/ATEX	3288	2,94	1,70	0,55	1380	69	9	19
CMP-616-4T/ATEX	1680	0,65	0,38	0,09	850	61	9	16
CMP-620-2T/ATEX	3288	2,08	1,20	0,37	765	68	11	21
CMP-620-4T/ATEX	1650	0,65	0,38	0,09	810	61	9	16
CMP-718-2T/ATEX	3426	3,46	2,00	0,75	1485	70	14	26
CMP-718-4T/ATEX	1692	2,08	1,20	0,25	1280	63	11	20
CMP-820-2T/ATEX	3414	4,50	2,60	1,10	1950	73	18	31
CMP-820-4T/ATEX	1620	2,08	1,20	0,25	1670	66	12	21
CMP-922-2T-1,5/ATEX	3414	4,50	2,60	1,10	1650	70	23	36
CMP-922-2T-2/ATEX	3432	6,24	3,60	1,50	2010	71	24	43
CMP-922-2T-3/ATEX	3456	8,66	5,00	2,20	2600	74	27	48
CMP-922-4T/ATEX	1674	2,94	1,70	0,55	2450	66	20	34
CMP-1025-2T-3/ATEX	3456	8,66	5,00	2,20	2100	73	29	50
CMP-1025-2T-4/ATEX	3474	12,12	7,00	3,00	2830	77	34	58
CMP-1025-4T/ATEX	1692	5,20	3,00	1,10	3400	70	27	46
CMP-1128-2T-4/ATEX	3474	12,12	7,00	3,00	2220	77	37	61
CMP-1128-2T-5,5/ATEX	3480	15,42	8,90	4,00	3210	81	41	62
CMP-1128-4T/ATEX	1704	9,01	5,20	2,20	5000	74	37	60
CMP-1231-4T-3/ATEX	1704	9,01	5,20	2,20	4740	73	46	69
CMP-1231-4T-4/ATEX	1704	12,30	7,10	3,00	5910	75	49	72
CMP-1231-4T-5,5/ATEX	1728	15,76	9,10	4,00	6850	77	53	77

Características técnicas

Modelo	Velocidad (r/min)	Intensidad máxima (A)		Potencia instalada (kW)	Caudal máximo (m³/h)	Nivel presión sonora dB(A)	Peso aprox. con motor (Kg)	
		220-277V	380-480V				Ex-e	Ex-d
CMP-1435-4T-4/ATEX	1704	12,30	7,10	3,00	5560	76	54	77
CMP-1435-4T-5.5/ATEX	1728	15,76	9,10	4,00	6260	78	61	85
CMP-1435-4T-7.5/ATEX	1746		12,00	5,50	7210	80	74	113
CMP-1640-4T-5.5/ATEX	1728	15,76	9,10	4,00	7000	77	79	103
CMP-1640-4T-7.5/ATEX	1746		12,00	5,50	8035	80	92	131
CMP-1640-4T-10/ATEX	1746		16,30	7,50	9710	82	100	134
CMP-1845-4T-7.5/ATEX	1746		12,00	5,50	8000	82	94	133
CMP-1845-4T-10/ATEX	1746		16,30	7,50	10000	85	102	136
CMP-2050-4T-10/ATEX	1746		16,30	7,50	9000	83	135	169
CMP-2050-4T-15/ATEX	1752		23,80	11,00	12525	87	162	259
CMP-2050-4T-20/ATEX	1746		30,60	15,00	16500	89	181	282

Características acústicas

Los valores indicados, se determinan mediante medidas de nivel de presión y potencia sonora en dB(A) obtenidas en campo libre a una distancia equivalente a dos veces la envergadura del ventilador más el diámetro de la turbina, con un mínimo de 1,5 mts.

Espectro de potencia sonora Lw(A) en dB(A) banda de frecuencia en [Hz]

Modelo	Lp dB (A)	63	125	250	500	1000	2000	4000	8000	Modelo	Lp dB (A)	63	125	250	500	1000	2000	4000	8000
CMP-616-2T/ATEX	69	44	54	65	72	76	73	71	64	CMP-1128-2T-5.5/ATEX	81	56	66	77	84	88	85	83	76
CMP-616-4T/ATEX	61	36	46	57	64	68	65	63	56	CMP-1128-4T/ATEX	74	49	59	70	77	81	78	76	69
CMP-620-2T/ATEX	68	43	53	64	71	75	72	70	63	CMP-1231-4T-3/ATEX	73	51	60	71	78	82	80	78	71
CMP-620-4T/ATEX	61	36	46	57	64	68	65	63	56	CMP-1231-4T-4/ATEX	75	53	62	73	80	84	82	80	73
CMP-718-2T/ATEX	70	45	55	66	73	77	74	72	65	CMP-1231-4T-5.5/ATEX	77	55	64	75	82	86	84	82	75
CMP-718-4T/ATEX	63	38	48	59	66	70	67	65	58	CMP-1435-4T-4/ATEX	76	54	63	74	81	85	83	81	74
CMP-820-2T/ATEX	73	48	58	69	76	80	77	75	68	CMP-1435-4T-5.5/ATEX	78	56	65	76	83	87	85	83	76
CMP-820-4T/ATEX	66	41	51	62	69	73	70	68	61	CMP-1435-4T-7.5/ATEX	80	58	67	78	85	89	87	85	78
CMP-922-2T-1.5/ATEX	70	45	55	66	73	77	74	72	65	CMP-1640-4T-5.5/ATEX	77	55	64	75	82	86	84	82	75
CMP-922-2T-2/ATEX	71	46	56	67	74	78	75	73	66	CMP-1640-4T-7.5/ATEX	80	58	67	78	85	89	87	85	78
CMP-922-2T-3/ATEX	74	49	59	70	77	81	78	76	69	CMP-1640-4T-10/ATEX	82	60	69	80	87	91	89	87	80
CMP-922-4T/ATEX	66	41	51	62	69	73	70	68	61	CMP-1845-4T-7.5/ATEX	82	61	71	82	89	93	91	89	81
CMP-1025-2T-3/ATEX	73	48	58	69	76	80	77	75	68	CMP-1845-4T-10/ATEX	85	64	74	85	92	96	94	92	84
CMP-1025-2T-4/ATEX	77	52	62	73	80	84	81	79	72	CMP-2050-4T-10/ATEX	83	62	72	83	90	94	92	90	82
CMP-1025-4T/ATEX	70	45	55	66	73	77	74	72	65	CMP-2050-4T-15/ATEX	87	66	76	87	94	98	96	94	86
CMP-1128-2T-4/ATEX	77	52	62	73	80	84	81	79	72	CMP-2050-4T-20/ATEX	89	68	78	89	96	100	98	96	88

Dimensiones mm

CMP-616...820

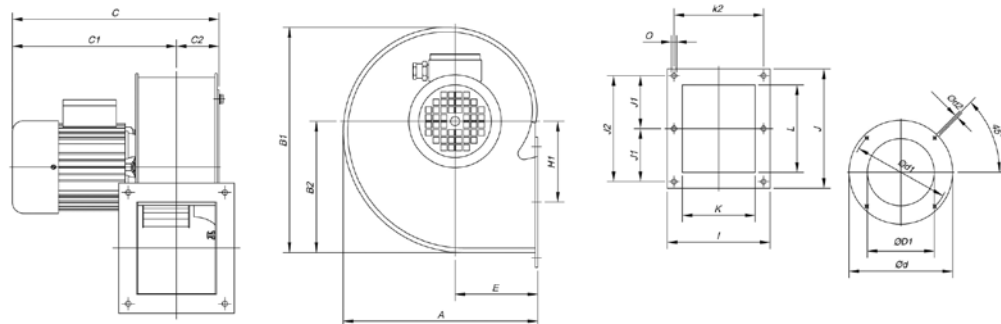

Modelo	A	B1	B2	C	C1	C2	øD1	ød	ød1	ød2	E	H1	I	J	J1	J2	K	k2	L	øO
CMP-616-2T/ATEX	258	297	173.5	375	318	56	160	204	180	M.6	110	105.5	153	172	-	147	103	128	125	7
CMP-616-4T/ATEX	258	297	173.5	345	288	56	160	204	180	M.6	110	105.5	153	172	-	147	103	128	125	7
CMP-620-2T/ATEX	298	347	202.5	376	320	56	200	247	230	M.6	126	145.5	159	153	-	128	105	134	100	8
CMP-620-4T/ATEX	298	347	202.5	345	290	56	200	247	230	M.6	126	145.5	159	153	-	128	105	134	100	8
CMP-718-2T/ATEX	303.5	348	201	396	335	64	180	238	210	M.6	129.5	122	169	192	85	170	115	145	146	9
CMP-718-4T/ATEX	303.5	348	201	385	324	64	180	238	210	M.6	129.5	122	169	192	85	170	115	145	146	9
CMP-820-2T/ATEX	322	377	223	411	343	68	200	247	230	M.6	137.5	137	184	213	94.5	189	130	160	156	9
CMP-820-4T/ATEX	322	377	223	400	332	68	200	247	230	M.6	137.5	137	184	213	94.5	189	130	160	156	9

Dimensiones mm

CMP-616...820

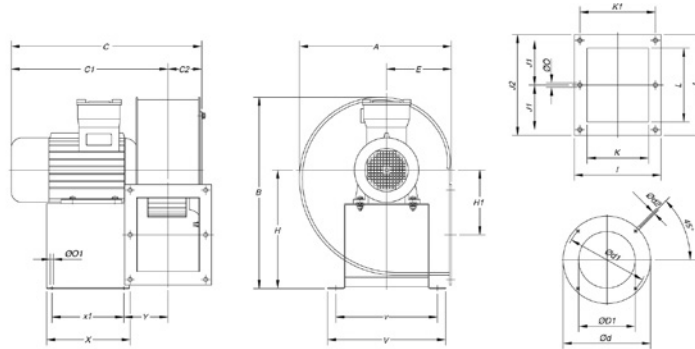

Modelo	A	B	C	C1	C2	øD1	ød	ød1	ød2	E	H	H1	I	J	J1	J2	K	k1	L	ø0	ø01	V	v	X	x1	Y
CMP (Ex-d)-616-2T	258	400	376	318.5	57.5	160	204	180	M.6	109.5	251	107	153	172	-	147	103	128	125	7	9	250	215	175	145	83.5
CMP (Ex-d)-616-4T	258	380	346	288.5	57.5	160	204	180	M.6	109.5	243	107	153	172	-	147	103	128	125	7	9	250	215	175	145	78.5
CMP (Ex-d)-620-2T	298	400	376	320	56	200	247	230	M.6	126	251	145.5	159	153	-	128	105	134	100	8	9	250	215	175	145	84.5
CMP (Ex-d)-620-4T	298	388	346	290	56	200	247	230	M.6	126	243	145.5	159	153	-	128	105	134	100	9	9	250	215	175	145	79.5
CMP (Ex-d)-718-2T	303.5	440	396	335	61	180	238	210	M.6	129.5	260	122	169	192	85	170	115	145	146	9	9	250	215	175	145	94.5
CMP (Ex-d)-718-4T	303.5	400	386	325	61	180	238	210	M.6	129.5	251	122	169	192	85	170	115	145	146	9	9	250	215	175	145	94.5
CMP (Ex-d)-820-2T	322	440	415	343.5	71.5	200	247	230	M.6	137.5	260	137	184	213	94.5	189	130	160	156	9	9	250	215	175	145	102
CMP (Ex-d)-820-4T	322	405	403	331.5	71.5	200	247	230	M.6	137.5	251	137	184	213	94.5	189	130	160	156	9	9	250	215	175	145	97

CMP-922...1231

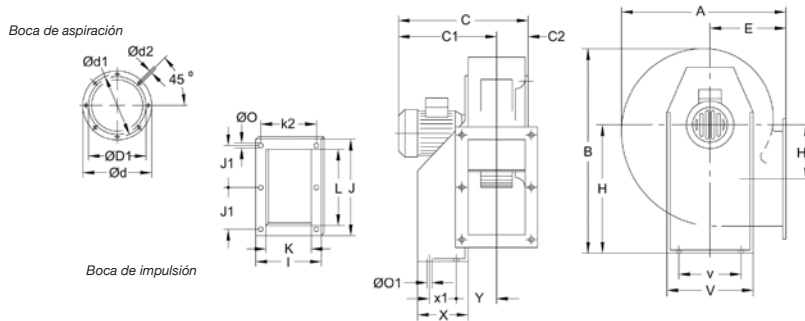

Modelo	Ex-"e"		Ex-"d"		C2	øD1*	ød	ød1	ød2	E	H	H1	I	J	J1	K	k2	L	ø0	ø01	V	v	X	x1	Y		
	A	B	C	C1																							
CMP-922-2T-1.5/ATEX	388.5	455	382	309	424	351	73,5	224	278	256	M.8	180	280	134	204	282,5	128	140	180	215	9,5	10,5	290	220	114	50	105
CMP-922-2T-2/ATEX	388.5	455	423,5	350	430,5	357	73,5	224	278	256	M.8	180	280	134	204	282,5	128	140	180	215	9,5	10,5	290	220	114	50	105
CMP-922-2T-3/ATEX	388.5	455	423,5	350	430,5	357	73,5	224	278	256	M.8	180	280	134	204	282,5	128	140	180	215	9,5	10,5	290	220	114	50	105
CMP-922-4T/ATEX	388.5	455	382,5	309	424	351	73,5	224	278	256	M.8	180	280	134	204	282,5	128	140	180	215	9,5	10,5	290	220	114	50	105
CMP-1025-2T-3/ATEX	427	503	456	370	466	380	86	250	305	282	M.8	197	310	144	229	312,5	145	165	205	250	9,5	12,5	315	228	134	74	115,5
CMP-1025-2T-4/ATEX	427	503	486	400	516	430	86	250	305	282	M.8	197	310	144	229	312,5	145	165	205	250	9,5	12,5	315	228	134	74	115,5
CMP-1025-4T/ATEX	427	503	456	370	466	380	86	250	305	282	M.8	197	310	144	229	312,5	145	165	205	250	9,5	12,5	315	228	134	74	115,5
CMP-1128-2T-4/ATEX	472	553	493,5	400	532,5	434	93,5	280	348	320	M.8	216	340	152	244	364	170	180	220	296,5	9,5	12,5	348	245	144	95	122,5
CMP-1128-2T-5.5/ATEX	472	553	553,5	451	553,5	451	93,5	280	348	320	M.8	216	340	152	244	364	170	180	220	296,5	9,5	12,5	348	245	144	95	122,5
CMP-1128-4T/ATEX	472	553	493,5	400	532,5	434	93,5	280	348	320	M.8	216	340	152	244	364	170	180	220	296,5	9,5	12,5	348	245	144	95	122,5
CMP-1231-4T-3/ATEX	526	630	520,5	417	547,5	444	103,5	315	382	354	M.8	238	390	179,5	264	382,5	180	200	240	320	11,5	13	382	322	183	140	126
CMP-1231-4T-4/ATEX	526	630	520,5	417	547,5	444	103,5	315	382	354	M.8	238	390	179,5	264	382,5	180	200	240	320	11,5	13	382	322	183	140	126
CMP-1231-4T-5.5/ATEX	526	630	543,5	440	576,5	434	103,5	315	382	354	M.8	238	390	179,5	264	382,5	180	200	240	320	11,5	13	382	322	183	140	126

*Diámetro nominal tubería recomendada

Dimensiones mm

CMP-1435...2050

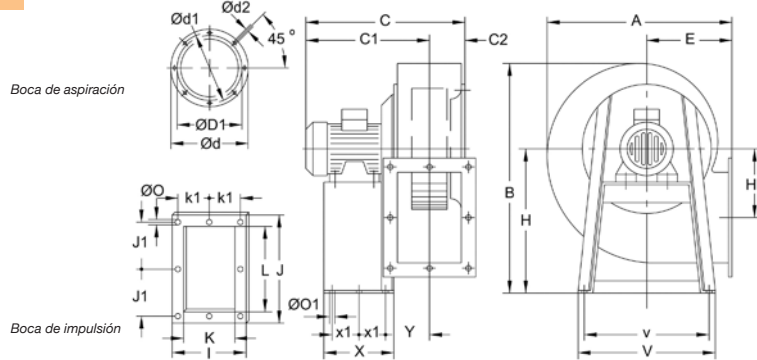

Modelo	Ex-"e"		Ex-"d"		C2	øD1*	ød	ød1	ød2	E	H	H1	I	J	J1	K	k1	L	ø0	ø01	V	v	X	x1	Y		
	A	B	C	C1																							
CMP-1435-4T-4/ATEX	573,5	715	527	409	577	459	118	355	422	394	M.8	250	445	242,5	292	342,5	159	228	133	280	11,5	12	456	420	333	136,5	150
CMP-1435-4T-5,5/ATEX	573,5	715	572	545	597	479	118	355	422	394	M.8	250	445	242,5	292	342,5	159	228	133	280	11,5	12	456	420	333	136,5	150
CMP-1435-4T-7,5/ATEX	573,5	715	610	492	670	552	118	355	422	394	M.8	250	445	242,5	292	342,5	159	228	133	280	11,5	12	456	420	333	136,5	150
CMP-1640-4T-5,5/ATEX	634	799	596	465	621	491	130	400	464	438	M.8	270	495	271	336	404	185	250	150	321	11,5	12	500	460	327	133,5	162,5
CMP-1640-4T-7,5/ATEX	634	799	634	504	693	563	130	400	464	438	M.8	270	495	271	336	404	185	250	150	321	11,5	12	500	460	327	133,5	162,5
CMP-1640-4T-10/ATEX	634	799	634	504	693	563	130	400	464	438	M.8	270	495	271	336	404	185	250	150	321	11,5	12	500	460	327	133,5	162,5
CMP-1845-4T-7,5/ATEX	711	901	668	521	727	580	147	450	515	485	M.8	302	560	305	370	444	202	284	164	361	11,5	12	538	502	340	140	179,5
CMP-1845-4T-10/ATEX	711	901	668	521	727	580	147	450	515	485	M.8	302	560	305	370	444	202	284	164	361	11,5	12	538	502	340	140	179,5
CMP-2050-4T-10/ATEX	797	987	700,5	538	759	596,5	162,5	500	565	535	M.10	345	610	313	411	544	250	315	182,5	451	11,5	12	653	615	435	188	196
CMP-2050-4T-15/ATEX	797	987	818,5	656	923,5	764,5	162,5	500	565	535	M.10	345	610	313	411	544	250	315	182,5	451	11,5	12	653	615	435	188	196
CMP-2050-4T-20/ATEX	797	987	859,5	697	923,5	764,5	162,5	500	565	535	M.10	345	610	313	411	544	250	315	182,5	451	11,5	12	653	615	435	188	196

*Diámetro nominal tubería recomendada

Curvas características

Ver serie CMP

Orientaciones

Suministro standard LG 270

Posiciones LG 180 y RD 180 bajo demanda y con medidas de anclaje especiales.

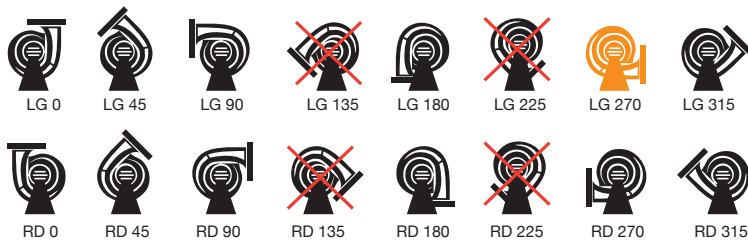

Accesorios



CMR/ATEX

Extractores centrífugos de media presión y gran robustez, equipados con turbina a reacción, con certificación ATEX



Extractores centrífugos de media presión y simple aspiración, de gran robustez, para trabajar en atmósferas explosivas.

Ventilador:

- Envoltorio en chapa de acero
- Turbina con álabes a reacción, en chapa de acero de gran robustez
- Aro de aspiración antichispas en cobre o aluminio

Motor:

- Motores clase F, con rodamientos a bolas, protección IP55, con certificación ATEX, antiexplosivos Ex"e" o antideflagrantes Ex"d"
- Motor Multitensión, diseño especial válido para: 220/380V 60Hz, 254/440V 60Hz, 265/460V 60Hz, 277/480V 60Hz
- Temperatura máxima del aire a transportar: -20°C.+ 80°C.



Ex "e" marcado: $\text{C} \llcorner \text{Ex} \text{ II } 2\text{G Ex e}$
 Ex "d" marcado: $\text{C} \llcorner \text{Ex} \text{ II } 2\text{G Ex d}$
 Ex tc marcado: $\text{C} \llcorner \text{Ex} \text{ II } 3\text{D Ex tc}$
 Ex tb marcado: $\text{C} \llcorner \text{Ex} \text{ II } 2\text{D Ex tb}$
Organismo notificado: L.O.M.
Nº de identificación: LOM3ATEX147

Acabado:

- Anticorrosivo con pintura ATEX, libre de componentes férricos, en resina de poliéster polimerizada a 190 °C, previo desengrase con tratamiento nanotecnológico libre de fosfatos

Bajo demanda:

- Motores con PTC incorporada
- Bobinados especiales para diferentes tensiones y frecuencias
- Construcción ATEX para diferentes categorías
- Construcción en acero inoxidable

Código de pedido

CMR/ATEX — 1650 — 2T — 5,5 — DIP65 — 60Hz

Extractores centrífugos de media presión y gran robustez, equipados con turbina a reacción, con certificación ATEX

Marcado:

$\text{C} \llcorner \text{Ex} \text{ II } 2\text{G c}$
 $\text{C} \llcorner \text{Ex} \text{ II } 2\text{D c}$
 $\text{C} \llcorner \text{Ex} \text{ II } 3\text{D c}$

Tamaño turbina

Número de polos motor

2=3500 r/min. 60 Hz
 4=1680 r/min. 60 Hz
 6=1080 r/min. 60 Hz

T=Trifásico

Potencia motor (c.v)

Ex-e: marcado: $\text{C} \llcorner \text{Ex} \text{ II } 2\text{G Ex e IIB T3}$
 Ex "d" marcado: $\text{C} \llcorner \text{Ex} \text{ II } 2\text{G Ex d IIB T5}$
 Ex tc marcado: $\text{C} \llcorner \text{Ex} \text{ II } 3\text{D Ex tc}$
 Ex tb marcado: $\text{C} \llcorner \text{Ex} \text{ II } 2\text{D Ex tb}$

Características técnicas

60Hz

Modelo	Velocidad (r/min)	Intensidad máxima (A)		Potencia instalada (kW)	Caudal máximo (m³/h)	Nivel presión sonora dB(A)	Peso aprox. con motor (Kg)	
		220-277V	380-480V				Ex-e	Ex-d
CMR-1240-4T/ATEX	1745	3,81	2,20	0,75	5800	71	70	84
CMR-1445-2T/ATEX	3500		15,70	7,50	16500	87	141	163
CMR-1445-4T/ATEX	1750	5,20	3,00	1,10	8030	72	93	112
CMR-1650-2T/ATEX	3490		22,00	11,00	18850	89	178	258
CMR-1650-4T/ATEX	1730	6,93	4,00	1,50	10500	74	114	134
CMR-1650-6T/ATEX	1165	4,16	2,40	0,75	7410	64	111	130
CMR-1856-4T/ATEX	1745	12,30	7,10	3,00	15150	79	152	175
CMR-1856-6T/ATEX	1160	5,89	3,40	1,10	10050	70	145	166
CMR-2063-4T/ATEX	1750		12,00	5,50	24450	80	225	264
CMR-2063-6T/ATEX	1120	7,62	4,40	1,50	16100	71	209	233
CMR-2271-4T/ATEX	1760		23,80	11,00	34610	85	315	412
CMR-2271-6T/ATEX	1140	14,72	8,50	3,00	22750	76	280	320
CMR-2380-4T/ATEX	1680		42,00	22,00	48000	83	416	495
CMR-2380-6T/ATEX	1080		16,40	7,50	30000	75	363	441

Características acústicas

Los valores indicados, se determinan mediante medidas de nivel de presión y potencia sonora en dB(A) obtenidas en campo libre a una distancia equivalente a dos veces la envergadura del ventilador más el diámetro de la turbina, con un mínimo de 1,5 mts.

Espectro de potencia sonora Lw(A) en dB(A) banda de frecuencia en [Hz]

Modelo	Lp dB (A)	63	125	250	500	1000	2000	4000	8000	Modelo	Lp dB (A)	63	125	250	500	1000	2000	4000	8000
CMR-1240-4T/ATEX	71	56	70	76	79	79	80	70	59	CMR-1856-6T/ATEX	70	61	69	81	83	80	81	71	60
CMR-1445-2T/ATEX	87	73	85	83	95	93	97	99	89	CMR-2063-4T/ATEX	80	80	85	91	93	91	88	81	73
CMR-1445-4T/ATEX	72	59	72	78	83	80	83	78	64	CMR-2063-6T/ATEX	71	69	70	82	82	81	83	73	63
CMR-1650-2T/ATEX	89	73	81	85	99	97	99	99	88	CMR-2271-4T/ATEX	85	83	84	93	96	98	99	95	82
CMR-1650-4T/ATEX	74	64	74	82	84	83	85	76	66	CMR-2271-6T/ATEX	76	73	73	87	86	90	90	79	68
CMR-1650-6T/ATEX	64	53	65	72	77	73	69	62	54	CMR-2380-4T/ATEX	83	76	78	94	91	96	97	93	82
CMR-1856-4T/ATEX	79	69	78	91	87	90	91	85	71	CMR-2380-6T/ATEX	75	68	70	86	83	88	89	85	74

Dimensiones mm

CMR-1240...2271

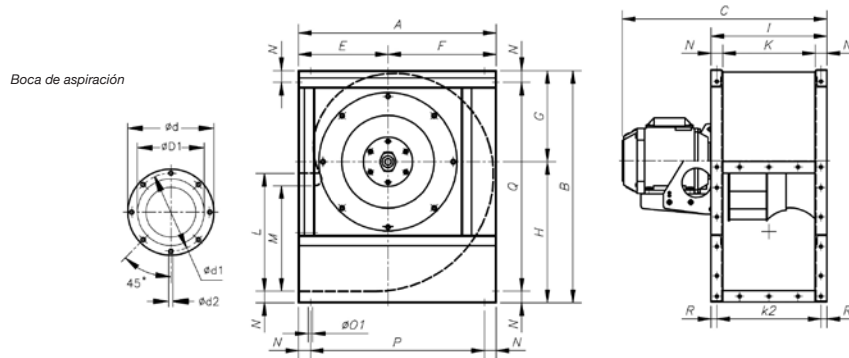

Ex-"e" Ex-"d"

Modelo	A	B	C	C	ØD1*	Ød	Ød1	Ød2	E	F	G	H	I	K	k2	L	M	N	Ø01	P	Q	R
CMR-1240-4T/ATEX	673	790	596	638	400	472	444	M.10	305	368	310	480	395	315	355	400	358	40	11	593	710	20
CMR-1445-2T/ATEX	765	880	774	857	450	522	494	M.10	350	415	339	541	445	355	403	450	404	45	11	675	790	21
CMR-1445-4T/ATEX	765	880	679	687	450	522	494	M.10	350	415	339	541	445	355	403	450	404	45	11	675	790	21
CMR-1650-2T/ATEX	832	970	945,5	1018	500	582	555	M.10	375	457	378	592	490	400	450	500	445	45	13	742	880	20
CMR-1650-4T/ATEX	832	970	724,5	724,5	500	582	555	M.10	375	457	378	592	490	400	450	500	445	45	13	742	880	20
CMR-1650-6T/ATEX	832	970	724,5	724,5	500	582	555	M.10	375	457	378	592	490	400	450	500	445	45	13	742	880	20
CMR-1856-4T/ATEX	925	1084	798	889	560	645	615	M.10	415	510	426	658	550	450	500	560	493	50	13	825	984	25
CMR-1856-6T/ATEX	925	1084	780,5	809	560	645	615	M.10	415	510	426	658	550	450	500	560	493	50	13	825	984	25
CMR-2063-4T/ATEX	1037	1218	937	1020	630	720	688	M.10	465	572	477	741	620	500	560	630	530	60	13	917	1098	30
CMR-2063-6T/ATEX	1037	1218	839	930	630	720	688	M.10	465	572	477	741	620	500	560	630	530	60	13	917	1098	30
CMR-2271-4T/ATEX	1173	1375	1129	1201	710	800	768	M.12	525	648	538	837	690	560	625	710	603	65	13	1043	1245	32,5
CMR-2271-6T/ATEX	1173	1375	973	1056	710	800	768	M.12	525	648	538	837	690	560	625	710	603	65	13	1043	1245	32,5

*Diámetro nominal tubería recomendada

CMR-1240...2380

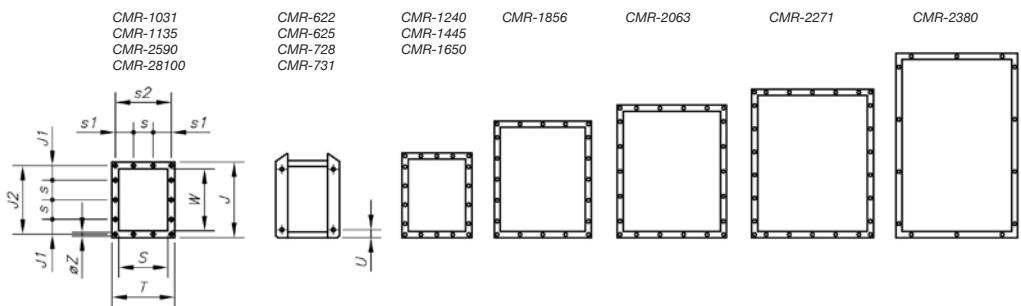

Modelo	T	J	J1	J2	S	s	s1	s2	W	Øz	U
CMR-1240	395	480	70	440	315	100	77,5	355	400	11	-
CMR-1445	445	540	99	498	355	100	102,5	403	450	11	-
CMR-1650	490	590	88	550	400	125	100	450	500	11	-
CMR-1856	550	660	55	610	450	125	125	500	560	13	-
CMR-2063	620	750	95	690	500	125	92,5	560	630	13	-
CMR-2271	690	840	75	775	560	125	62,5	625	710	13	-
CMR-2380	680	920	160	871	560	200	140	639	800	14	-

Dimensiones mm

CMR-2380

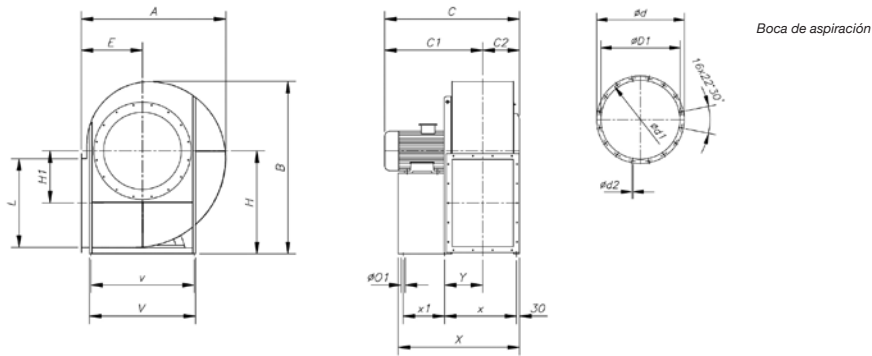

Modelo	Ex-"e"		Ex-"d"		C2	ØD1*	Ød	Ød1	Ød2	E	H	H1	L	Ø01	V	v	X	x	x1	Y		
	A	B	C	C1																		
CMR-2380-4T/ATEX	1350	1660	1019	733	1063	777	286	808	906	861	11,5	560	1000	500	800	17	930	870	1102,5	667,5	370	352,5
CMR-2380-6T/ATEX	1350	1660	590	304	716	430	286	808	906	861	11,5	560	1000	500	800	17	930	870	1102,5	667,5	370	352,5

*Diámetro nominal tubería recomendada

Curvas características

Ver serie CMR

Orientaciones

Suministro standard LG 270



Accesorios



RECUPERADORES DE CALOR • UNIDADES DE FILTRACIÓN Y TRATAMIENTO DE AIRE

413

RECUP

Recuperadores de calor configurables, con placas de flujo cruzado, para instalación horizontal (H) o vertical (V)

419

SV/FILTER

Extractores en línea para conductos, con bajo nivel sonoro y diferentes etapas de filtración.

423

UFR

Unidades de Filtración aisladas acústicamente con panel sándwich

427

UDT

Unidades de ventilación con tratamiento de aire y motor directo.

431

UDTX

Unidades de ventilación con tratamiento de aire a transmisión.

437



RECUPERADORES DE CALOR, UNIDADES DE FILTRACIÓN Y TRATAMIENTO DE AIRE

Debido al objetivo internacional y también de la Unión Europea, de fomentar la mejora de la eficiencia energética de los edificios, SODECA presenta este nuevo catálogo de Recuperadores de Calor y unidades de filtración, adaptados a las normativas europeas más exigentes, para dar soluciones a las necesidades planteadas y para conseguir el grado de eficiencia deseado en cada edificio.

El trabajo en equipo de nuestro departamento de ingeniería, junto con universidades y centros tecnológicos, así como la estrecha colaboración con nuestros clientes, ha hecho posible conseguir innovadoras soluciones para las actuales necesidades de los mercados que apuestan por una mejora importante de la eficiencia energética.

La unión de la experiencia adquirida durante décadas de trabajo con ventiladores, junto con la tecnología aportada por diferentes departamentos de ingeniería, ha permitido que Sodeca se sitúe entre los mayores fabricantes de ventilación del mundo.

NUESTROS PROPÓSITOS

- Ahorro de energía y en consecuencia ahorro de recursos naturales.
- Mejora de la Eficiencia Energética.
- Reducción de la contaminación acústica.
- Protección del medio ambiente.
- Reducción de emisiones de CO₂.

Para aquellos países miembros de la Unión Europea, los equipos de unidades de tratamiento de aire tendrán que cumplir con nuevas exigencias en materia de eficiencia energética.

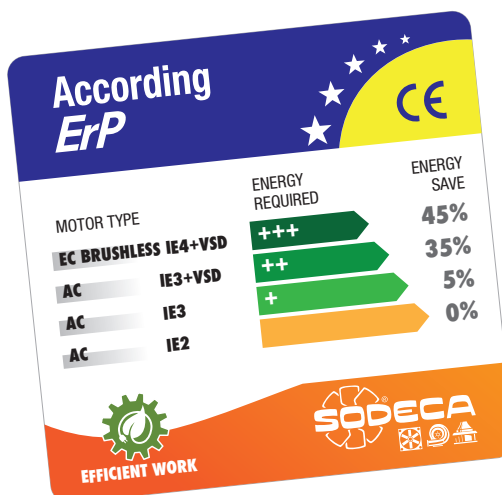
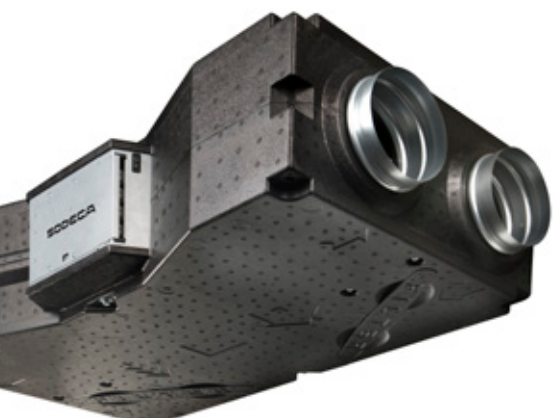

RECUPERADORES DE CALOR



El recuperador de calor funciona mediante la combinación de dos ventiladores centrífugos de bajo nivel sonoro, donde uno de ellos realiza la extracción del aire viciado del interior del local hacia la calle y el otro impulsa aire fresco del exterior hacia el interior del local. Los dos circuitos se cruzan sin mezclarse, en un intercambiador, donde el calor del aire saliente, se transfiere al aire fresco del exterior y lo calienta.

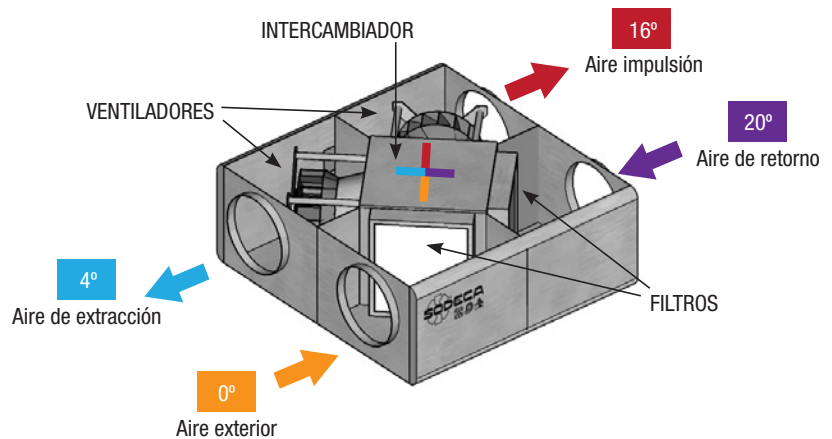

UNIDADES DE FILTRACIÓN



Las unidades de filtración limpian el aire de partículas garantizando la calidad del mismo.

Componentes de las unidades de filtración:

- Ventilador centrífugo en una estructura de caja cerrada.
- Etapas de prefiltración y filtración.
- Elementos de control del estado de los filtros: Manómetros y presostatos.
- Elementos de control del caudal constante.

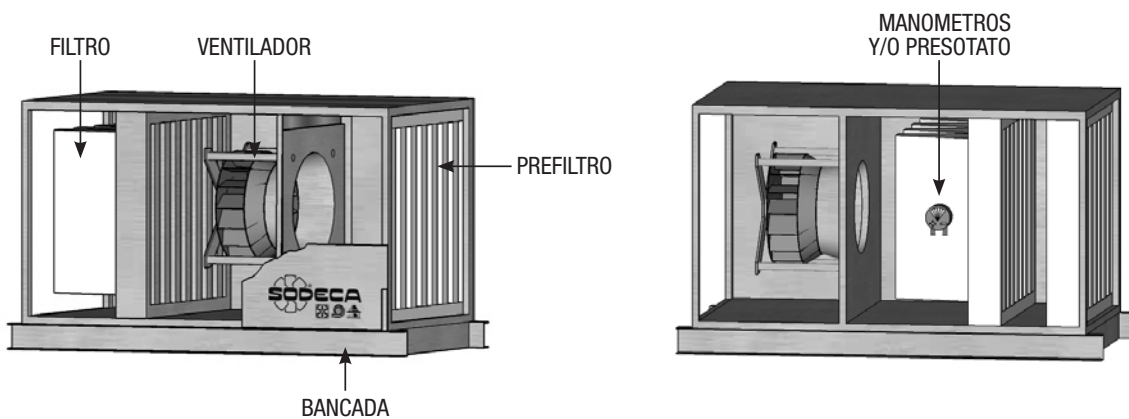

POSICIÓN DE ETAPAS FILTRANTES

RECUPERADORES DE CALOR

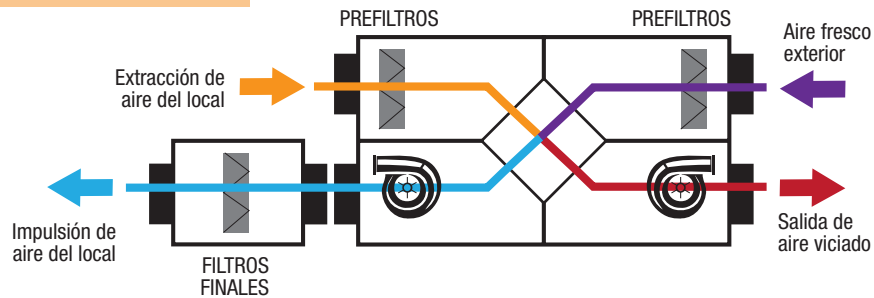

UNIDADES DE FILTRACIÓN

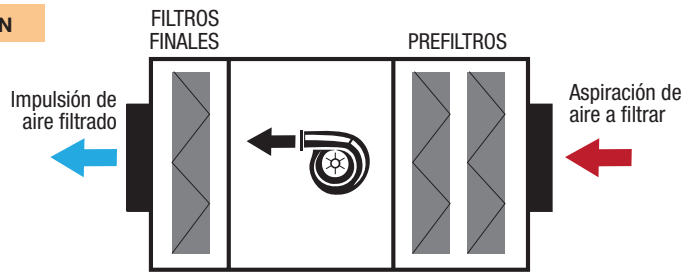

TIPOS DE INSTALACIÓN



Mural

Equipos domésticos para recuperación de calor en pequeñas estancias.



En falso techo

Equipos de perfil bajo y acceso a componentes desde los laterales o la parte inferior.



En cubierta

Equipos que pueden trabajar en exteriores y con acceso a los componentes desde los laterales de los mismos. Pueden requerir accesorios como tejadillos o viseras para protección contra lluvia u otros elementos.



En sala técnica

Equipos compactos de acceso lateral a componentes. Los equipos con las bocas situadas en la parte superior son el caso más típico.

INTERCAMBIADOR DE CALOR

El intercambiador de calor es el componente del recuperador que transfiere calor del circuito de extracción de aire viciado del local, hacia el circuito de aportación de aire limpio exterior. A mayor eficiencia térmica del intercambiador, menor necesidad de aporte adicional de climatización. Principales tipos de intercambiadores según su construcción:



Placas de flujos cruzados

- . 50-70% de eficiencia térmica.
- . Sin fugas entre los circuitos de aire.
- . Compactos y económicos.



Placas a contraflujo

- . 80-95% de eficiencia térmica.
- . Sin fugas entre los circuitos de aire.
- . Requieren equipos de mayor tamaño.

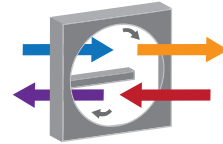

Rotativos

- . 70-85% de eficiencia térmica.
- . Compactos.
- . Pueden funcionar en modo BY-PASS.

Los intercambiadores pueden ser de tipo calor sensible o entálpico. Los entálpicos recuperan calor y humedad, con lo que la eficiencia es superior, pero precisan de limpiezas regulares para un funcionamiento seguro.

MOTORIZACIONES

Tipos de motor que pueden llevar los ventiladores de los equipos:

- . AC: Motores convencionales de alta eficiencia. Pueden disponer de varias velocidades o regulación de velocidad según modelos o accesorios.
- . EC: Motores de mayor eficiencia con capacidad de regulación proporcional.

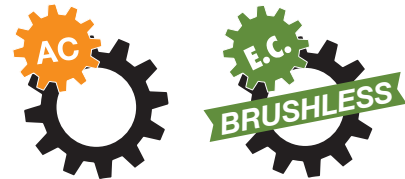

BY-PASS TÉRMICO

El BY-PASS es un dispositivo que desvía el caudal de aire y evita que pase a través del recuperador de calor y el intercambio térmico de la unidad.

Las ventajas son:

- . Enfriamiento rápido del aire del local (free cooling). Permite enfriar el local rápidamente cuando la temperatura del local es demasiado alta y la exterior es más adecuada a la necesidad.
- . Protección contra congelación (sólo en intercambiadores de placas). Disminuye el riesgo de congelación en invierno.
- . En los equipos con intercambiador rotativo la función del BY-PASS se consigue mediante el paro del giro del rotor.
- . En los equipos con intercambiadores de placas, el BY-PASS es un circuito alternativo al paso por el mismo.

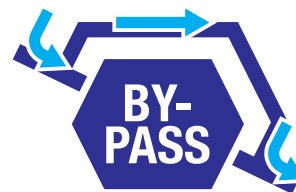

OPCIONES DE CLIMATIZACIÓN

Algunos equipos disponen de versiones o accesorios de baterías de calentamiento o enfriamiento del aire de aportación. Esto es muy común en recuperadores aunque también se pueden aplicar a unidades de filtración. Las opciones más habituales son las siguientes:



Versión ambiental.
Sin aporte de climatización.



Versión batería eléctrica.
Aporte de calefacción mediante baterías eléctricas.



Versión batería de agua.
Aporte de tratamiento térmico mediante baterías de agua fría o caliente.

CONTROL AUTOMÁTICO

En los recuperadores, el control automático puede aportar una gran variedad de funciones según series o modelos de equipos, las más significativas son:

- Programación horaria.
- Número de velocidades y posibilidad de regulación de velocidad variable (VSD).
- Control de caudal según niveles de CO2 o presión de aire en conducto.
- Conexión del equipo a un sistema de control centralizado (BMS), habitualmente mediante protocolo MODBUS RTU.



En el caso de las unidades de filtración, se dispone de:

- Manómetros y presostatos que permiten detectar la necesidad de reemplazo de los filtros
- Accesorios que regulan el ventilador para estabilizar el caudal y aumentar la vida de los filtros.

FILTROS

Los filtros retienen partículas que afectan a la calidad de aire y deben reemplazarse tras un periodo de uso. La pérdida de carga de los filtros aumenta progresivamente.

En algunos equipos se dispone de elementos de control de pérdida de carga, con el fin de optimizar el reemplazo de los filtros.

- Tomas de presión: Pequeñas tomas de aire que permiten detectar la pérdida de carga de las etapas filtrantes.
- Manómetro diferencial: Detección visual de la pérdida de carga por etapa filtrante.
- Presostato: Interruptor de presión que conmuta un circuito eléctrico según la lectura de la pérdida de carga de los filtros.

Cada etapa de filtración dispone de uno o más filtros de la misma eficacia, según las necesidades de cada aplicación. Los equipos según su configuración pueden incorporar:

- Etapa con prefiltros que garantizan el buen funcionamiento del equipo, según exigencias de la instalación, las eficiencias podrán ser: G4, F6, F7.
- Etapas con filtros finales que aseguran la calidad del aire de aportación al local, las eficiencias suelen ser tipo: F6, F7, F8, F9, CA (De gases de carbón activo) o incluso HEPA, según la categoría de IDA/ODA.



RECUP



Recuperadores de calor configurables, con placas de flujo cruzado, para instalación horizontal (H) o vertical (V)



RECUP-H



RECUP-V

Características:

- Intercambiador de placas de aluminio con rendimientos entre 52%-55%
- Posibilidad de configuración entre diferentes posiciones de bocas
- Filtros incorporados, calidad G4, F6 y F6+F8. Otras combinaciones bajo pedido.
- Caja en acero galvanizado con aislamiento acústico integrado

- Puertas de acceso para facilitar el mantenimiento y la limpieza

Versiones:

- Horizontal (H) o Vertical (V)
- Ambiental: Renovación de aire, sin aportación de calefacción (S)

Bajo demanda:

- Eléctrica: Con aportación de calefacción mediante baterías eléctricas (EB)
- Batería de agua: Con aportación de calefacción mediante baterías de agua (WB)
- Módulo Adiabático.

Construcción:

- Estructura construida en chapa de acero galvanizado
- Bocas de entrada y salida con junta estanca
- Bocas intercambiables



Código de pedido

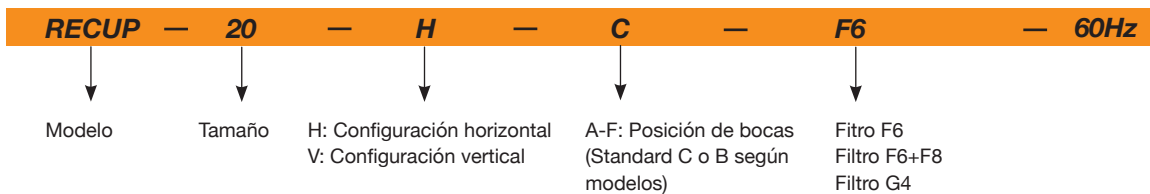

Características técnicas



Modelo	Velocidad (r/min)	Tensión (V)	Intensidad (A)	Potencia motor (W)	Caudal máximo F6(m³/h)	Eficiencia térmica (%)	NPS irradiado dB(A)	Filtro EN 779	Peso (Kg)
RECUP-12-H	1710	1x220	2x2,00	2x450	1300	52	53	G4, F6, F6+F8	67
RECUP-20-H	1620	1x220	2x2,00	2x450	2050	52	48	G4, F6, F6+F8	86
RECUP-20-V	1620	1x220	2x2,00	2x450	2050	52	48	G4, F6, F6+F8	86
RECUP-30-H	1500	1x220	2x5,40	2x600	3150	54	52	G4, F6, F6+F8	112
RECUP-30-V	1500	1x220	2x5,40	2x600	3150	54	52	G4, F6, F6+F8	112
RECUP-40-H	1080	3x380	2x3,60	2x1100	4250	55	46	G4, F6, F6+F8	167
RECUP-40-V	1080	3x380	2x3,60	2x1100	4250	55	46	G4, F6, F6+F8	167
RECUP-50-H	1536	3x380	2x3,50	2x1500	5350	53	54	G4, F6, F6+F8	182
RECUP-50-V	1536	3x380	2x3,50	2x1500	5350	53	54	G4, F6, F6+F8	182
RECUP-60-H	1740	3x380	2x4,83	2x2200	6150	50	56	G4, F6, F6+F8	205
RECUP-60-V	1740	3x380	2x4,83	2x2200	6150	50	56	G4, F6, F6+F8	205

Configuraciones (Versión Horizontal)

Suministro standard configuración C. Excepto modelo 12 configuración B.

Configuración A

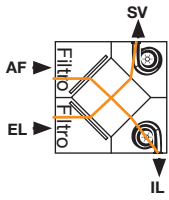

Configuración B

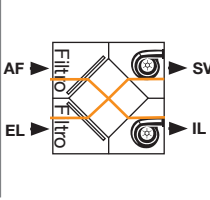

Configuración C



Configuración D

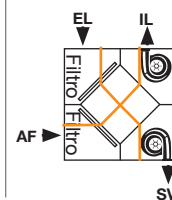

Configuración E

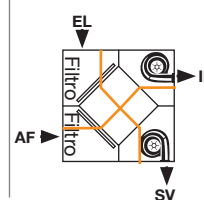

Configuración F

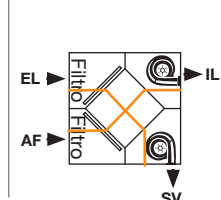

AF: Aire fresco exterior / IL: Impulsión aire al local / SV: Salida aire viciado / EL: Extracción aire del local

Dimensiones mm

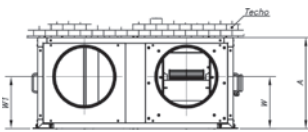

RECUP H F6

	A	B	L	øD	H1	H2	H3	W	W1
RECUP-12-H	415	1000	1000	315	260,4	479,2	260,4	207,5	207,5
RECUP-20-H	490	1050	1050	315	251	548	251	280	280
RECUP-30-H	590	1100	1200	315	266	668	266	350	350
RECUP-40-H	670	1500	1500	450	350	800	350	368	368
RECUP-50/60-H	850	1500	1700	450	351,5	997	351,5	424,5	424,5



RECUP H F6+F8

	A	B	B1	L	øD	H1	H2	H3	W	W1	W2	W3
RECUP-12-H	415	1000	1525	1000	315	260,4	479,2	260,4	207,5	207,5	207,5	207,5
RECUP-20-H	490	1050	1575	1050	315	251	548	251	250	280	280	280
RECUP-30-H	590	1100	1625	1200	315	266	668	266	320	350	350	350
RECUP-40-H	670	1500	2025	1500	450	350	800	350	368	368	368	368
RECUP-50/60-H	849	1500	2025	1700	450	351,5	997	351,5	424,5	424,5	424,5	424,5



Dimensiones mm

RECUP V F6

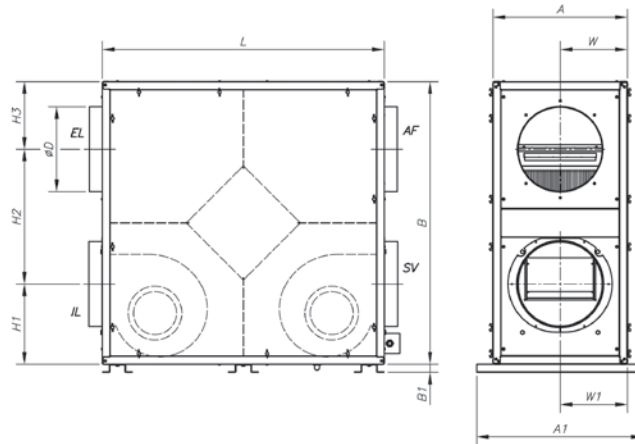

	A	A1	B	B1	L	øD	H1	H2	H3	W	W1
RECUP-20-V	500	620	1050	30	1050	315	298	501	251	250	250
RECUP-30-V	600	720	1202	30	1102	315	384	548	270	300	300
RECUP-40-V	670	790	1500	30	1500	450	391,5	739	369,5	334	335
RECUP-50-V	805	925	1700	30	1500	450	441	912	347	402,5	402,5
RECUP-60-V	805	925	1700	30	1500	450	441	912	347	402,5	402,5

RECUP V F6+F8

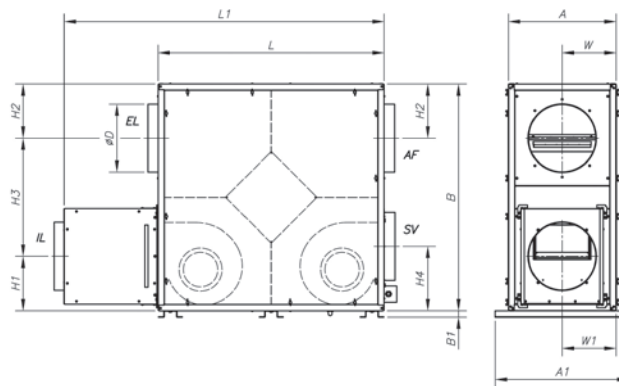

	A	A1	B	B1	L	L1	øD	H1	H2	H3	H4	W	W1
RECUP-20-V	500	620	1050	30	1050	1487	315	252	501	251	298	250	250
RECUP-30-V	600	720	1202	30	1102	1540	315	335	548	270	384	300	300
RECUP-40-V	670	790	1500	30	1500	1933	450	369,5	739	369,5	391,5	334	335
RECUP-50-V	805	925	1700	30	1500	1933	450	403,5	912	347	441	402,5	402,5
RECUP-60-V	805	925	1700	30	1500	1933	450	403,5	912	347	441	402,5	402,5

Características acústicas

Los valores indicados se determinan mediante medidas de potencia sonora en dB(A) obtenidas en campo libre a una distancia no inferior a 1,5 m del equipo.

Espectro de potencia sonora Lw(A) en dB(A) por banda de frecuencia en Hz

Modelo	63	125	250	500	1000	2000	4000	8000
RECUP-12	54	56	49	52	54	50	45	38
RECUP-20	49	51	44	47	49	45	40	33
RECUP-30	54	56	50	51	48	43	35	31

Modelo	63	125	250	500	1000	2000	4000	8000
RECUP-40	49	51	43	37	36	30	29	15
RECUP-50	57	59	50	44	42	36	37	22
RECUP-60	59	61	52	46	44	38	39	24

Curvas características

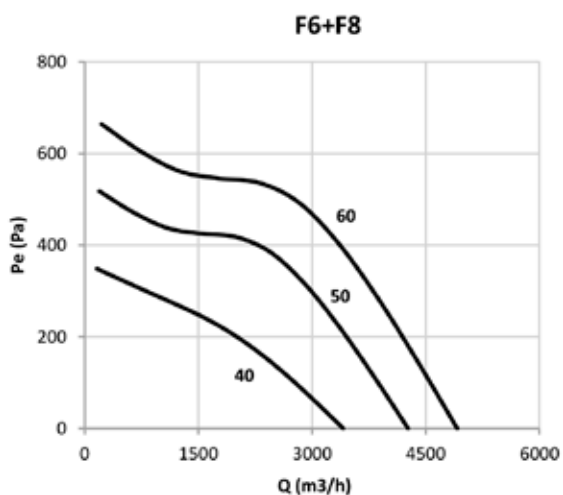
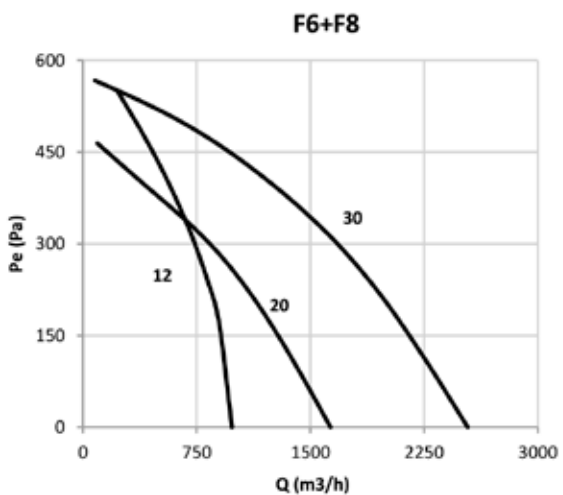
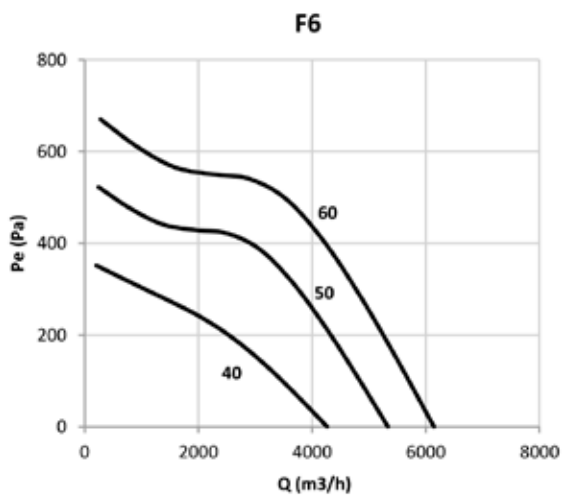
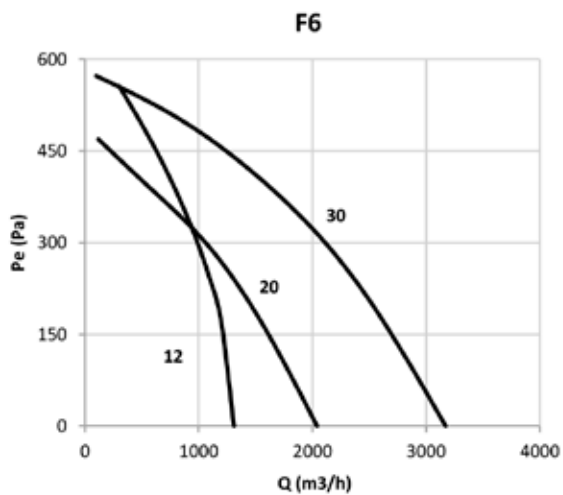

Accesorios



SV/FILTER

Extractores en línea para conductos, con bajo nivel sonoro y diferentes etapas de filtración



G4 + F6

F6 + F8

F7 + F9



Características:

- Envoltorio acústico recubierto de material fonoabsorbente
- Bridas normalizadas en aspiración e impulsión, para facilitar la instalación en conductos.
- Filtros G4 + F6, F6 + F8 y F7 + F9 según modelo
- Tapa de inspección y limpieza de fácil acceso

Construcción:

- Envoltorio en chapa de acero galvanizado
 - Turbina con álabes a reacción, excepto modelos 125 y 150 con turbina multipala
- Se suministra con 4 pies soporte, que facilita su montaje

- Puertas de acceso para facilitar el mantenimiento y la limpieza

Motor:

- Motores de rotor exterior, con protector térmico incorporado, clase F, con rodamientos a bolas, protección IP-54
- Monofásicos 220V. 60Hz. Regulables
- Temperatura máxima del aire a transportar +50°C

Acabado:

- Anticorrosivo en resina de poliéster polimerizada a 190 °C, previo desengrase con tratamiento nanotecnológico libre de fosfatos.

Código de pedido

SV/FILTER — 200/H — F7+F9 — 60Hz



Modelo



Tamaño



Combinación de filtros

Características técnicas

60Hz

Modelo	Velocidad (r/min)	Intensidad máxima admisible (A) 220V	Potencia instalada (kW)	Caudal máximo (m³/h)			Nº Prefiltros	Nº Filtros	Dimensiones filtros (mm)		Peso (Kg)
				Filtros (G4+F6)	Filtros (F6+F8)	Filtros (F7+F9)			Filtros (G4)	Filtros (F)	
SV/FILTER-125/H	2664	0,65	0,08	300	255	240	1	1	282x194x48	282x194x98	9,1
SV/FILTER-150/H	2640	1,25	0,17	445	385	360	1	1	334x216x48	334x216x98	12,3
SV/FILTER-200/H	1488	0,85	0,12	515	520	390	1	1	389x248x48	389x248x98	15,1
SV/FILTER-250/H	2856	0,95	0,14	660	560	525	1	1	414x267x48	414x267x98	17,8
SV/FILTER-315/H	1596	0,75	0,12	1035	850	790	1	1	513x344x48	513x344x98	26,4
SV/FILTER-350/H	1536	0,95	0,14	1550	1270	1180	1	1	602x385x48	602x385x98	36,3
SV/FILTER-400/H	1596	1,8	0,3	2050	1720	1600	1	1	660x405x48	660x405x98	46,4

Dimensiones mm

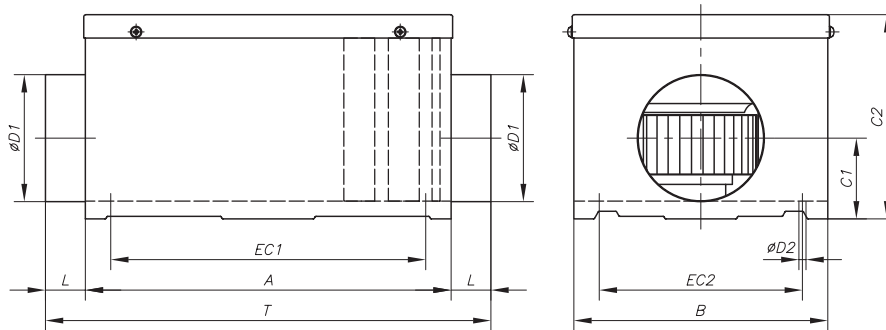

Modelo	A	B	C1	C2	Ø D1	L	Ø D2	EC1	EC2	T
SV/FILTER-125/H	657	290	80	222	125	36,5	7	607	240	730
SV/FILTER-150/H	700	340	92	244	150	36,5	7	650	290	773
SV/FILTER-200/H	775	395	117	273	200	36	7	725	345	847
SV/FILTER-250/H	775	395	140	293	250	50	7	725	345	875
SV/FILTER-315/H	860	520	175	371	315	48	8.5	809	469	956
SV/FILTER-350/H	960	610	200	410	355	48	8.5	909	564	1056
SV/FILTER-400/H	1035	670	219	455	400	38	8.5	984	624	1111

Curvas características

Curva del equipo según filtros incorporados **1** G4+F6 **2** F6+F8 **3** F7+F9

Presión Estática

Presión Dinámica

Potencia Absorbida

SV/FILTER 125/H

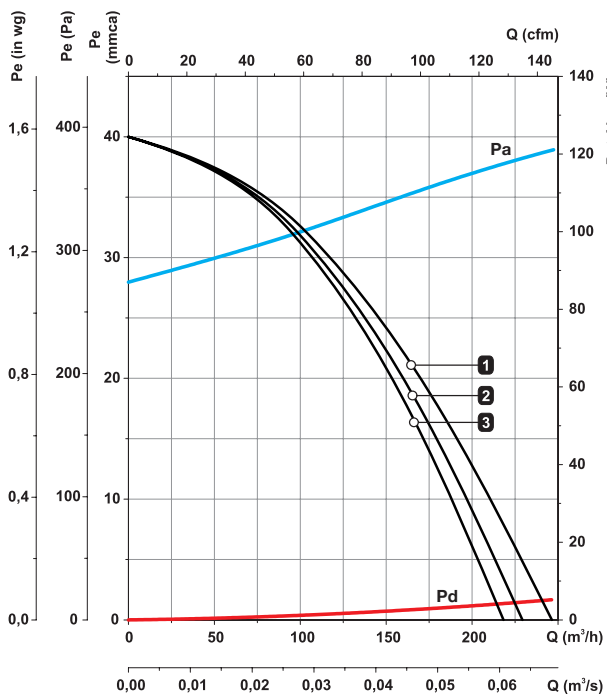

SV/FILTER 150/H

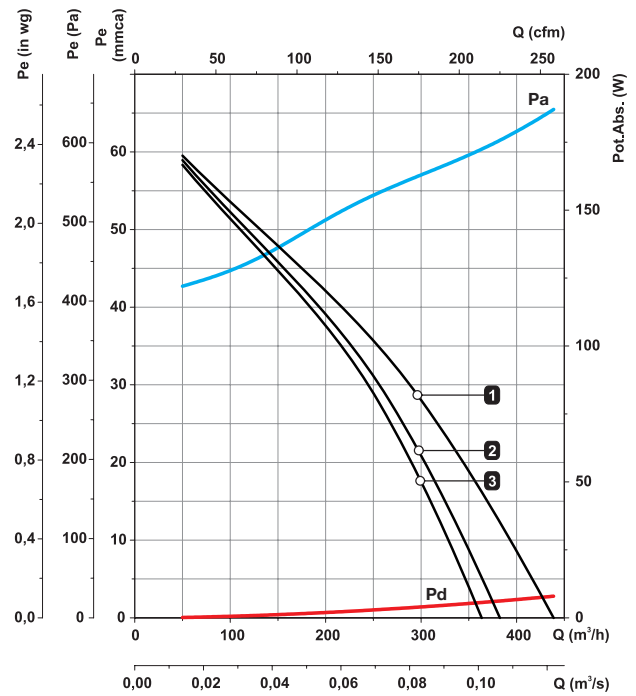

Curvas características

Curva del equipo según filtros incorporados **1** G4+F6 **2** F6+F8 **3** F7+F9

Presión Estática

Presión Dinámica

Potencia Absorbida

SV/FILTER 200/H

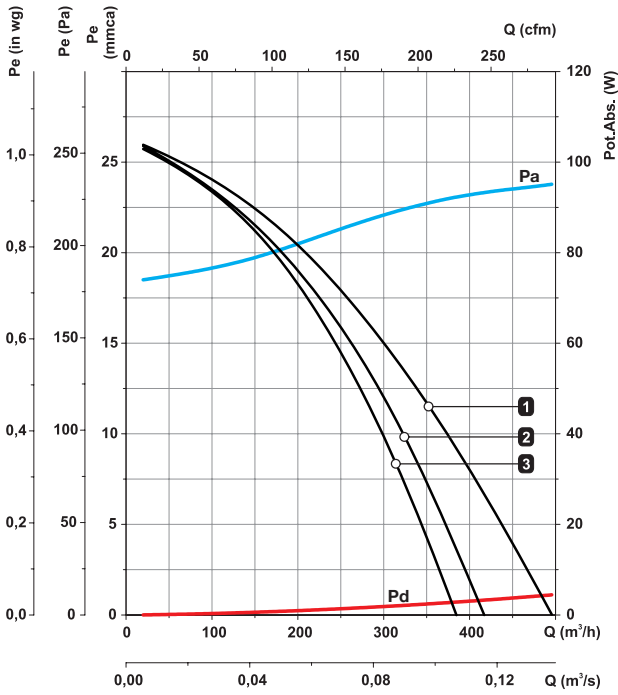

SV/FILTER 250/H

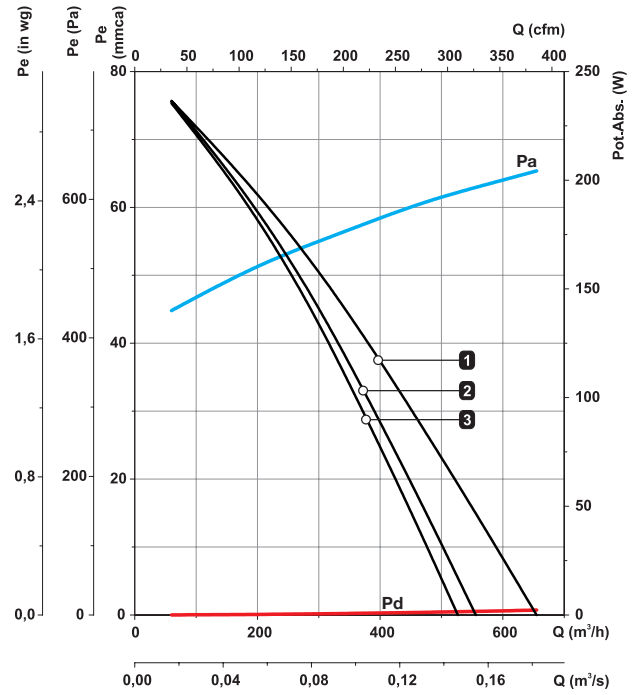

SV/FILTER 315/H

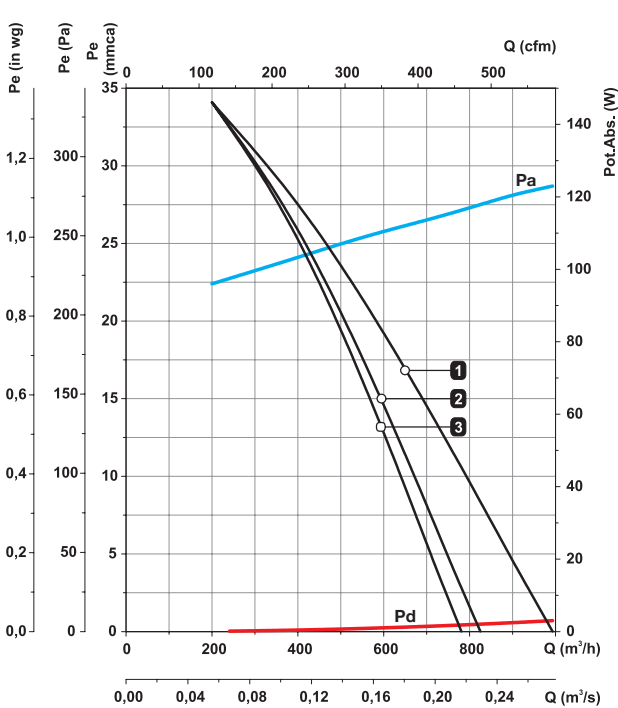

SV/FILTER 350/H

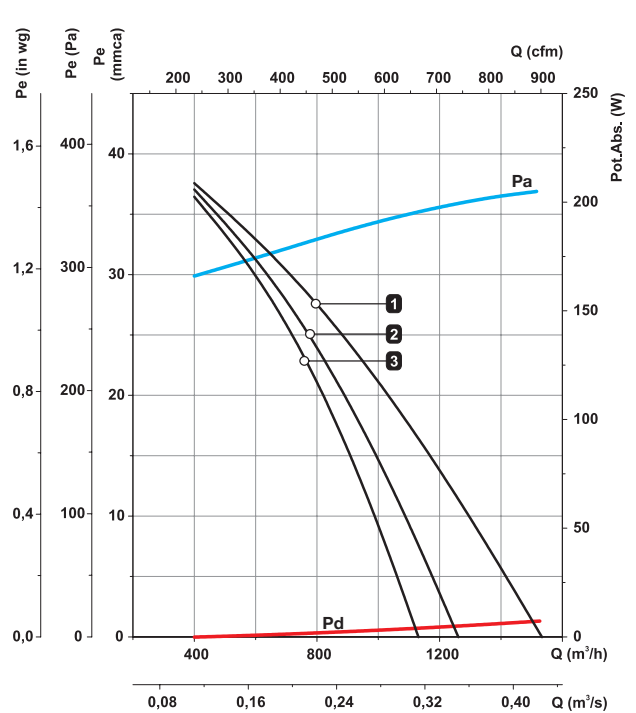

Curvas características

Curva del equipo según filtros incorporados **1** G4+F6 **2** F6+F8 **3** F7+F9

Presión Estática

Presión Dinámica

Potencia Absorbida

SV/FILTER 400/H

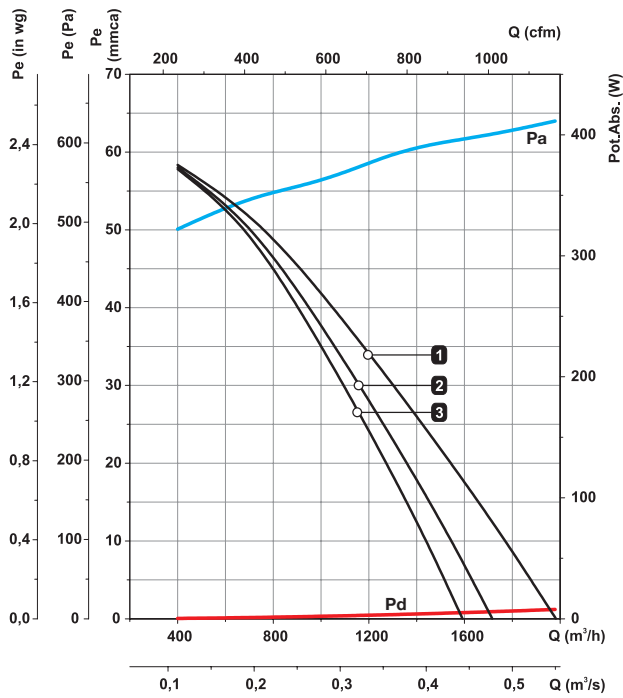

Accesorios



FILTROS



CJFILTER



PRESOSTATO



SI-PRESIÓN



SONDA DE PRESIÓN



INT



VIS



TEJ

UFR

Unidades de Filtración aisladas acústicamente con panel sándwich, equipadas con ventiladores de turbina a reacción de alto rendimiento, y diferentes etapas de filtración según modelo.



Características:

- Estructura aislada acústicamente
- Accionamiento directo
- Impulsión de aire, configurable por 4 laterales
- Filtros F6 + F8, F7 + F9 y G4 + F6 según modelo seleccionado
- Posibilidad de prefiltro, más dos etapas de filtración
- Tapa de inspección y limpieza de fácil acceso
- Tomas de presión para control de filtros
- Sonda de presión para control de filtros

- Turbina con álabes a reacción de alto rendimiento, en chapa de acero
- Bancada general incorporada

Motor:

- Motores clase F, con rodamientos a bolas, protección IP55
- Motor Multitensión, diseño especial válido para: 220/380V 60Hz, 254/440V 60Hz, 265/460V 60Hz, 277/480V 60Hz
- Temperatura del aire a transportar: -20°C +60°C

Acabado:

- Anticorrosivo en chapa de acero galvanizado

Construcción:

- Estructura en chapa de acero galvanizado, con aislamiento acústico



Código de pedido

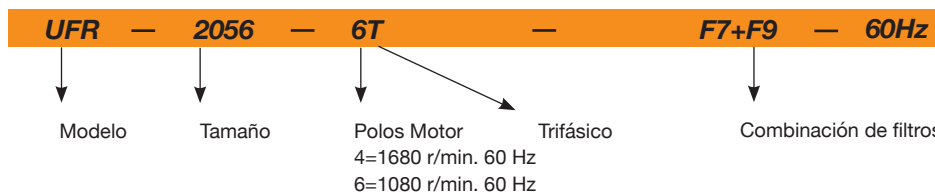

Características técnicas

60Hz

Modelo	Velocidad (r/min)	Intensidad máxima admisible (A)		Potencia instalada (kW)	Caudal máximo (m³/h) Filtros (F6+F8)	Caudal máximo (m³/h) Filtros (F7+F9)	Caudal máximo (m³/h) Filtros (G4+F6)	Nº Prefiltros		Nº Filtros		Peso (Kg)
		220-277V	380-480V					Entero*	Medio*	Entero*	Medio*	
UFR-1240-4T	1716	3,34	1,93	0,75	3.245	3.185	3.005	1	0	1	0	107,5
UFR-1850-4T	1704	5,97	3,45	1,5	4.705	4.620	4.350	1	0	1	0	110
UFR-2056-4T	1716	8,38	4,84	2,2	7.680	7.580	7.235	1	2	1	2	168,5
UFR-2056-6T	1122	3,77	2,18	0,75	5.325	5.250	5.010	1	2	1	2	163
UFR-2263-4T	1752		11,03	5,5	11.995	11.680	11.375	1	2	1	2	221,5
UFR-2263-6T	1140	5,23	3,02	1,1	7.200	7.100	7.000	1	2	1	2	177,5
UFR-2071-4T	1752		20,64	11	15.045	14.535	14.060	1	2	1	2	265
UFR-2071-6T-3	1128	9,28	5,36	2,2	9.175	8.990	8.810	1	2	1	2	195
UFR-2071-6T-5,5	1164	16,35	9,44	4	10.130	9.770	9.440	1	2	1	2	241,5
UFR-2880-6T	1164	16,35	9,44	4	11.500	11.165	10.845	1	2	1	2	242

*Dimensiones prefiltro: Entero: 585x585x48. Medio: 290x585x48
*Dimensiones filtro: Entero: 593x593x292. Medio: 288x593x292

Dimensiones mm

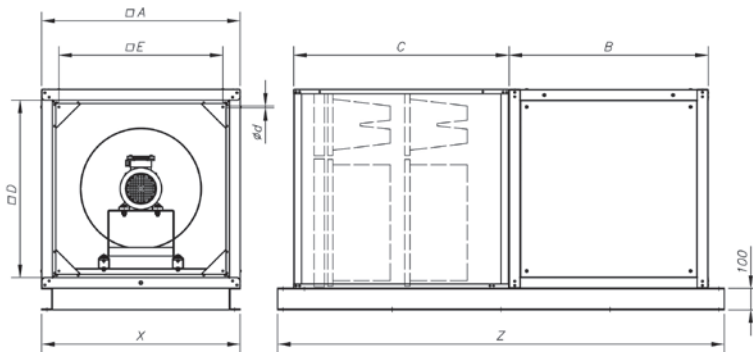

Modelo	A	B	C	D	E	Ø d	X	Z
UFR-1240-4T	800	800	950	700	640	M6	800	1906
UFR-1850-4T	800	800	950	700	640	M6	800	1906
UFR-2056-4T	925	925	1000	823	763	M6	925	2081
UFR-2056-6T	925	925	1000	823	763	M6	925	2081
UFR-2263-4T	1000	1000	1000	960	838	M6	1000	2156
UFR-2263-6T	925	925	1000	960	763	M6	925	2081
UFR-2071-4T	1060	1060	1000	960	900	M6	1060	2216
UFR-2071-6T	1000	1000	1000	960	838	M6	1000	2156
UFR-2071-6T-5,5	1060	1060	1000	960	900	M6	1060	2216
UFR-2880-6T	1060	1060	1000	960	900	M6	1060	2216

Accesorios



Curvas características

Curva del equipo según filtros incorporados **1** F6+F8 **2** F7+F9 **3** G4+F6

Presión Estática Presión Dinámica Potencia Absorbida

UFR-1240-4T

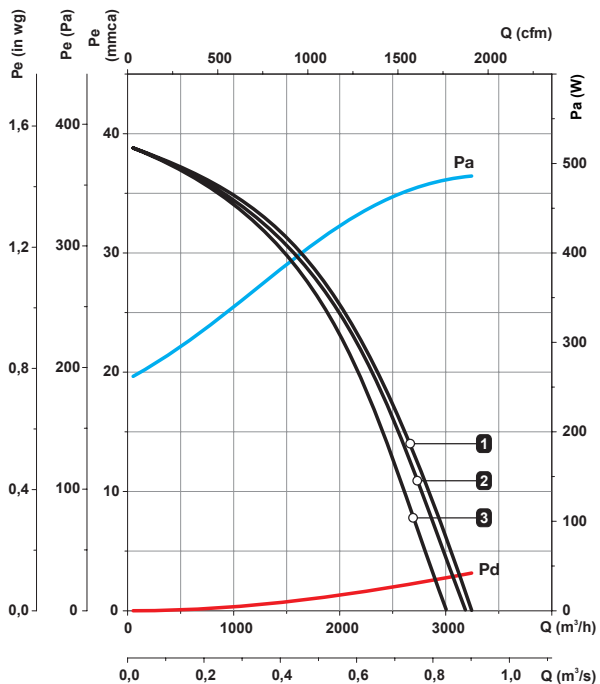

UFR-1850-4T

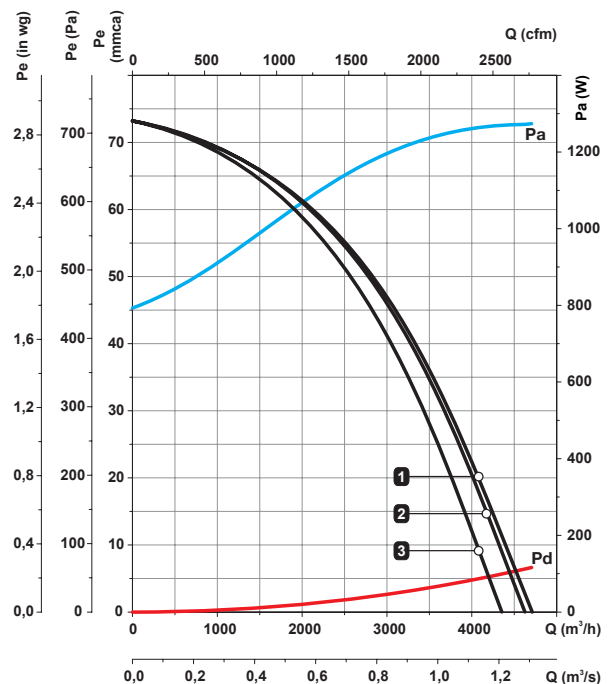

Curvas características

Curva del equipo según filtros incorporados **1** F6+F8 **2** F7+F9 **3** G4+F6

Presión Estática

Presión Dinámica

Potencia Absorbida

UFR-2056-4T

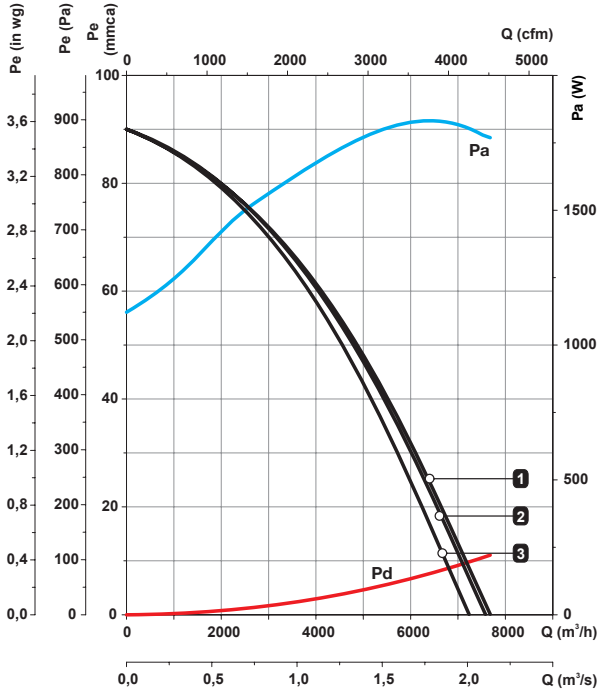

UFR-2056-6T

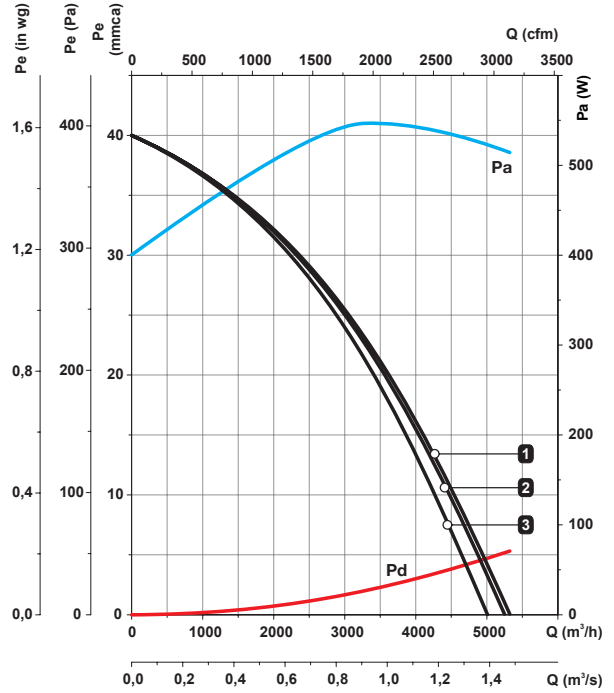

UFR-2263-4T

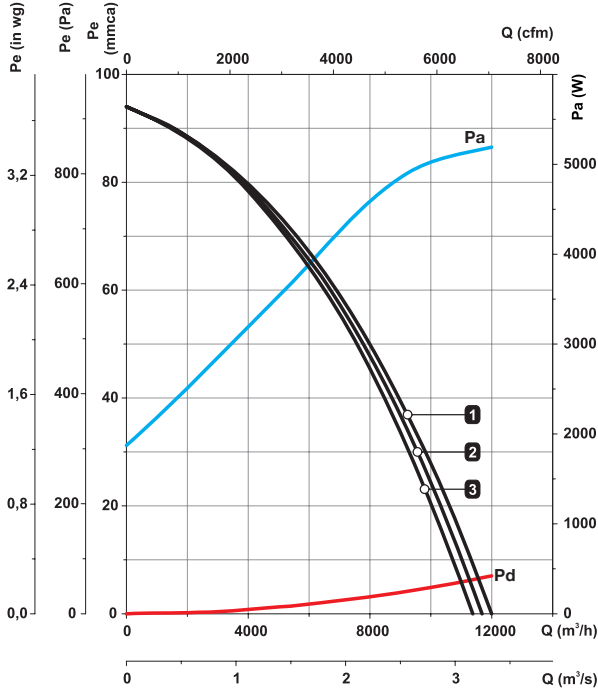

UFR-2263-6T

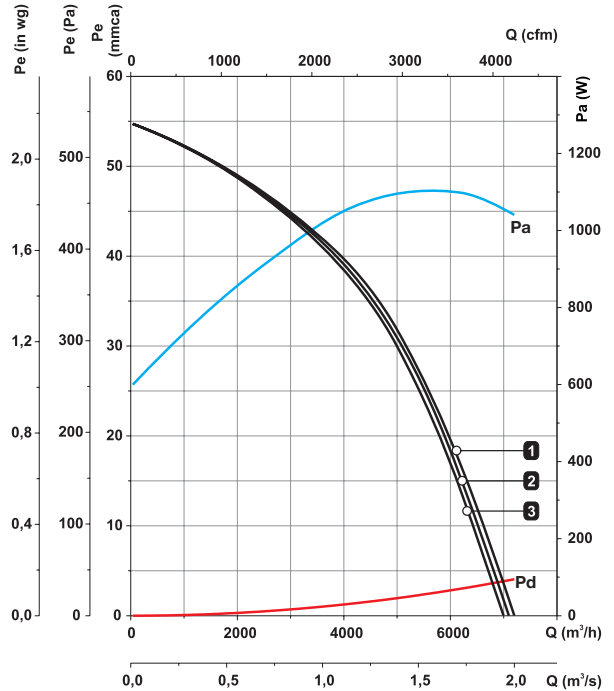

Curvas características

Curva del equipo según filtros incorporados **1** F6+F8 **2** F7+F9 **3** G4+F6

Presión Estática

Presión Dinámica

Potencia Absorbida

UFR-2071-4T

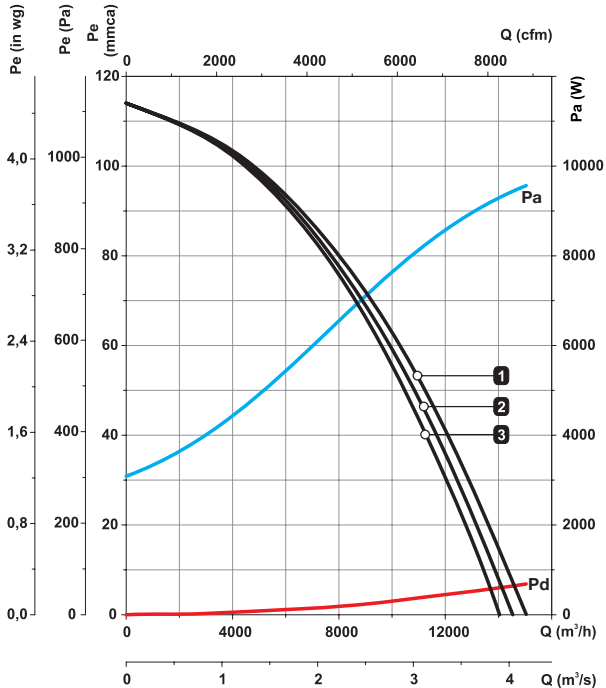

UFR-2071-6T-3

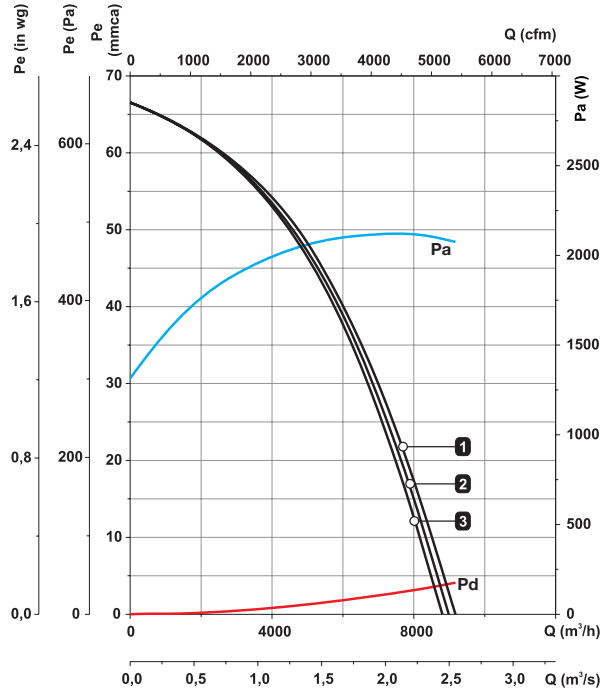

UFR-2071-6T-5.5

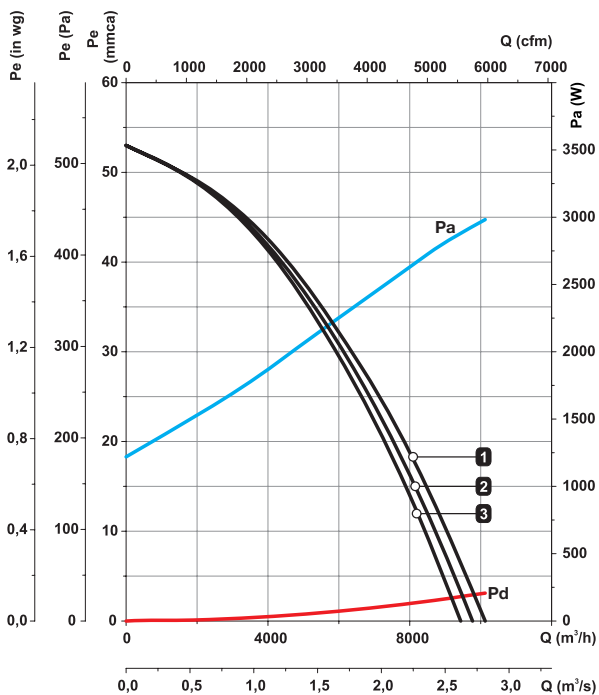

UFR-2880-6T

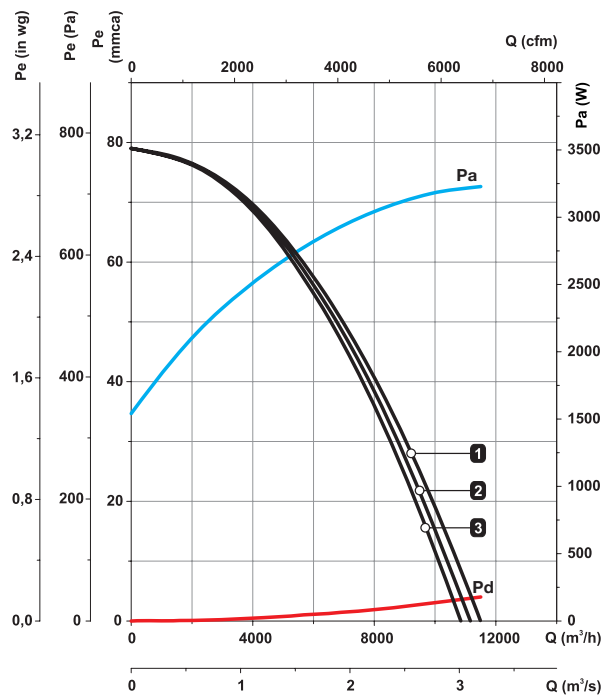

UDT

Unidades de ventilación con tratamiento de aire y motor directo, aisladas acústicamente, equipadas con ventiladores de doble aspiración y opciones de módulos de filtración, calefacción eléctrica o por agua



Caja:

- Estructura en perfilería de aluminio con aislamiento térmico y acústico.
- Panel de acceso lateral, para su correcto mantenimiento.
- Construcción modular, para añadir módulos de filtros o de tratamiento de aire.
- Prensaestopas para entrada de cable.

Ventilador:

- Unidades de ventilación equipadas con ventiladores de la serie CBD.
- Turbinas con álabes hacia adelante, en chapa de acero galvanizado.

Motor:

- High efficiency (HE) motores para cumplimiento de ErP 2015
- Motores clase F, con rodamientos a bolas, protección IP54.

- Motor Multitensión, diseño especial válido para: 220/380V 60Hz, 254/440V 60Hz, 265/460V 60Hz, 277/480V 60Hz
- Temperatura máxima del aire a transportar: -20°C.+ 60°C.

Versiones:

- MF: Módulo de filtración. Versión estándar F6+F8 y opcional F7+F9.
- ME: Módulo con batería eléctrica. Versión estándar G4 y opcional con filtros F6+F8 o F7+F9.
- MA: Módulo con batería de agua. Versión estándar G4 y opcional con filtros F6+F8 o F7+F9.

Bajo demanda:

- Impulsión vertical.
- Módulo montado en impulsión.

Código de pedido

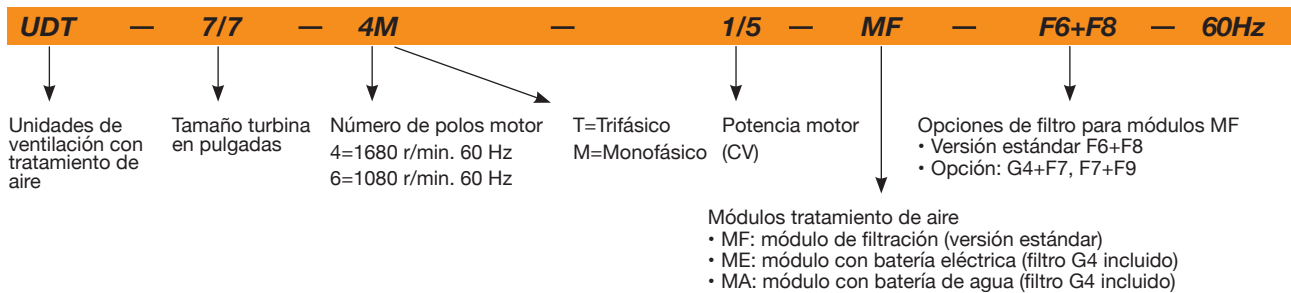

Características técnicas



Modelo	Velocidad (r/min)	Intensidad máx admisible (A)		Potencia instalada (kW)	Caudal máximo (m3/h)	Nivel Sonoro dB(A)	Peso aprox (Kg)
		220 V	380 V				
UDT-7/7-4M 1/5	1476	1,4		0,15	1520	60,90	22,5
UDT-9/9-4M 1/2	1584	3,3		0,37	2800	69,30	31,8
UDT-9/9-4M 3/4	1572	4,5		0,55	3600	73,50	32,6
UDT-10/10-4M 1/2	1584	3,3		0,37	2800	68,25	37,3
UDT-10/10-4M 3/4	1572	4,5		0,55	3950	73,50	38,1
UDT-12/12-6T 1 1/2	1080	6,6	3,8	1,1	7800	77,70	53,8
UDT-12/12-6M 3/4	1020	5		0,55	4900	66,15	52,3
UDT-12/12-6M 1	1020	6		0,75	6000	73,50	53,3
UDT-15/15-6T 3	1068	10,9	6,3	2,2	11900	77,70	80

Dimensiones mm

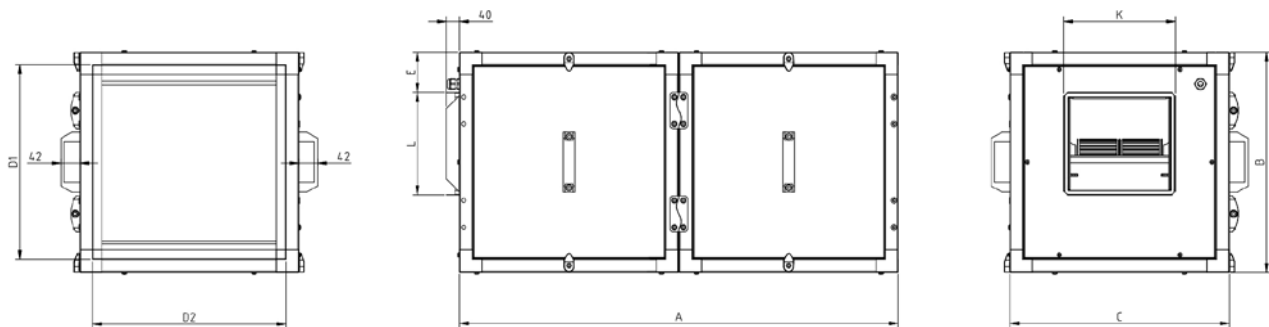

Modelo	A	B	C	D1	D2	E	L	K
UDT-7/7	981	490	490	428	428	91	226	247
UDT-9/9	1041	550	550	488	488	86	279	317
UDT-10/10	1096	605	605	543	543	88	306	343
UDT-12/12	1171	680	680	618	618	84	360	404
UDT-15/15	1346	855	855	793	793	119	423	490

Características acústicas

Espectro de potencia sonora Lw(A) en dB(A) por banda de frecuencia en Hz

Modelo	63	125	250	500	1000	2000	4000	8000
7/7-4M 1/5	43	54	58	62	64	63	62	53
9/9-4M 1/2	51	62	66	70	72	71	70	61
9/9-4M 3/4	55	66	70	74	76	75	74	65
10/10-4M 1/2	50	61	65	69	71	70	69	60
10/10-4M 3/4	55	66	70	74	76	75	74	65
12/12-6T 1 1/2	59	70	74	78	80	79	78	69
12/12-6M 3/4	48	59	63	67	69	68	67	58
12/12-6M 1	55	66	70	74	76	75	74	65
15/15-6T 3	61	72	77	81	83	81	80	71

Opciones módulos tratamiento de aire



MF: Módulos de filtración

- Estructura en perfilera de aluminio con aislamiento térmico y acústico.
- Panel de acceso lateral, para su correcto mantenimiento.
- Construcción modular, para añadir módulos de filtros o de tratamiento de aire.
- Módulo versión estándar F6+F8 y opcional F7+F9.
- Compatibles con las series UDT, UDTX, CJBD/ALG, CJBD/ALS, CJBX/ALG y CJBX/ALS.



ME: Módulos con batería eléctrica

- Estructura en perfilera de aluminio con aislamiento térmico y acústico.
- Panel de acceso lateral, para su correcto mantenimiento.
- Construcción modular, para añadir módulos de filtros o de tratamiento de aire.
- Prensaestopas para entrada de cable.
- Módulo versión estándar G4 y opcional con filtros F6+F8 o F7+F9.
- Compatibles con las series UDT, UDTX, CJBD/ALG, CJBD/ALS, CJBX/ALG y CJBX/ALS.



MA: Módulos con batería de agua

- Estructura en perfilera de aluminio con aislamiento térmico y acústico.
- Panel de acceso lateral, para su correcto mantenimiento.
- Construcción modular, para añadir módulos de filtros o de tratamiento de aire.
- Módulo versión estándar G4 y opcional con filtros F6+F8 o F7+F9.
- Compatibles con las series UDT, UDTX, CJBD/ALG, CJBD/ALS, CJBX/ALG y CJBX/ALS.

MF: Características módulo de filtración

F Pérdida de carga de filtros

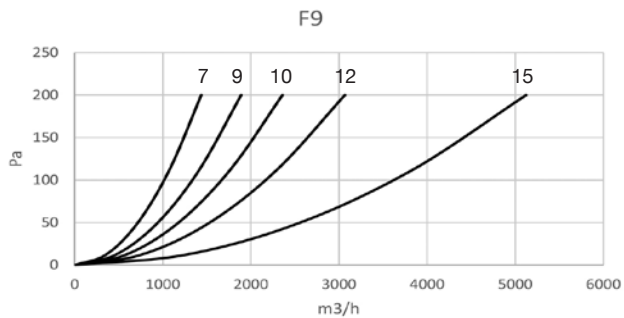
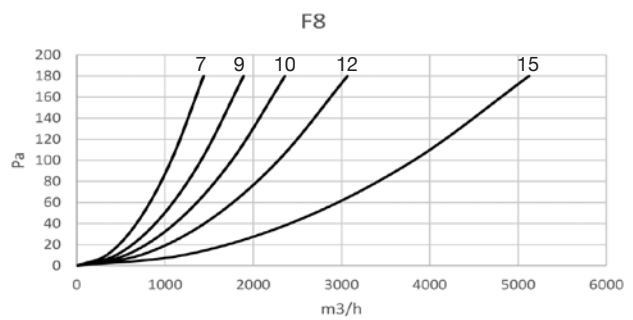
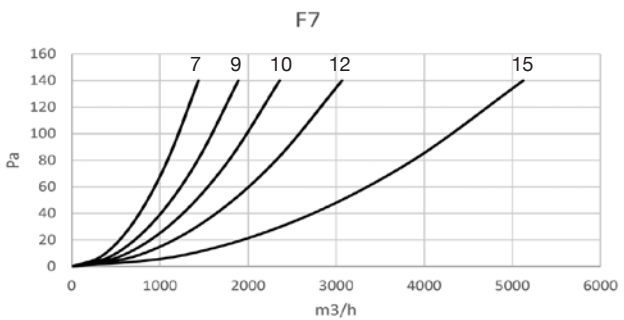
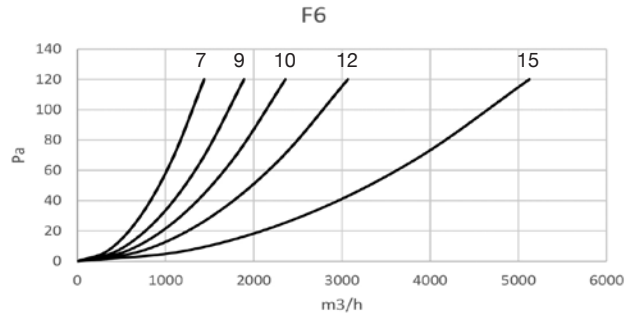
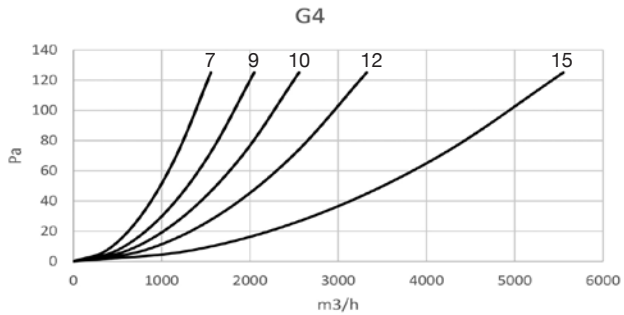

7= MF 7/7
 9= MF 9/9
 10= MF 10/10
 12= MF 12/12
 15= MF 15/15

ME: Características módulos batería eléctrica



Modelo	Intensidad (A)	Potencia instalada (kW)			Caudal máximo (m ³ /h)	Peso aprox (Kg)	
		380-480V	Etapas 1	Etapas 2			Etapas 3
ME-7/7	13		3	3	3	1500	23
ME-9/9	23		5.4	5.4	5.4	3300	33
ME-10/10	33		7.7	7.7	7.7	4500	44
ME-12/12	52		12	12	12	6000	61
ME-15/15	81		18.8	18.8	18.8	10000	96

Pérdida de carga de baterías eléctricas

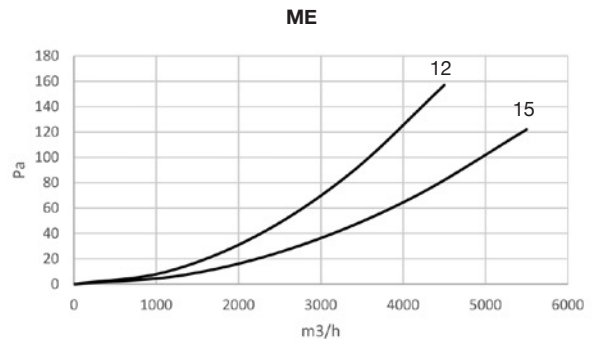
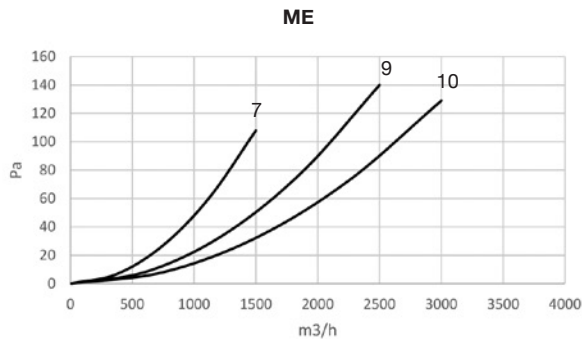

MA: Características módulos batería de agua 90/70°C con aire a 0°C



Modelo	Potencia (kW)	Caudal máximo (m ³ /h)	Caudal agua (m ³ /h)	Pérdida carga agua (kPa)	Conexión (pulg)	Peso aprox. (Kg)
MA-7/7	23	1500	1.0	16.3	1/2"	18
MA-9/9	37	2500	1.7	26.6	1/2"	25
MA-10/10	46	3000	2.0	17.6	3/4"	31
MA-12/12	66	4500	2.9	29.8	3/4"	39
MA-15/15	108	5500	4.8	21.4	1"	63

MA: Características módulos batería de agua 80/60°C con aire a 0°C



Modelo	Potencia (kW)	Caudal máximo (m ³ /h)	Caudal agua (m ³ /h)	Pérdida carga agua (kPa)	Conexión (pulg)	Peso aprox. (Kg)
MA-7/7	20	1500	0.9	13.0	1/2"	18
MA-9/9	33	2500	1.4	21.3	1/2"	25
MA-10/10	40	3000	1.7	14.0	3/4"	31
MA-12/12	58	4500	2.5	23.8	3/4"	39
MA-15/15	100	5500	4.2	17.5	1"	63

Pérdida de carga de baterías de agua

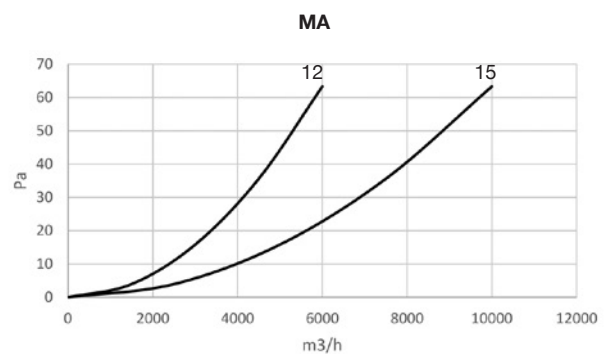
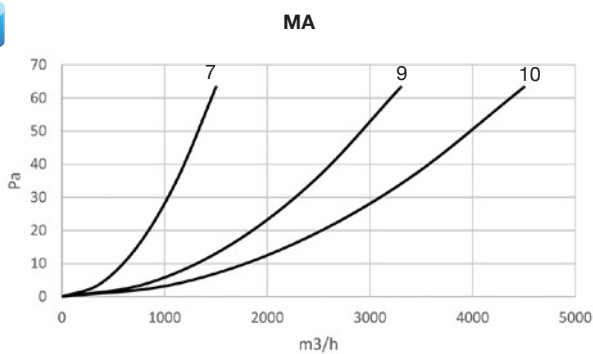

Esquemas de instalación y posición filtros

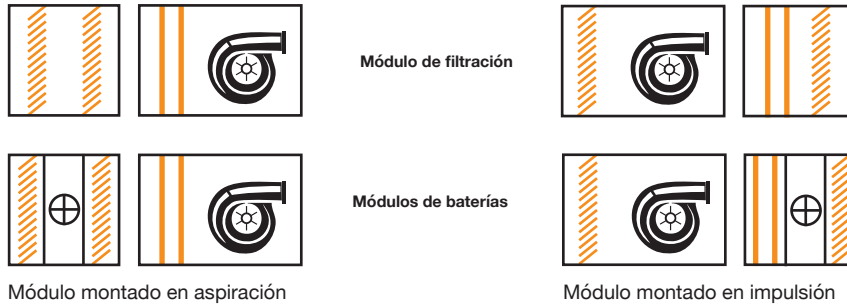

Dimensiones de los módulos mm

Compatibles con las series UDT, UDTX, CJBD/ALG, CJBD/ALS, CJBX/ALG y CJBX/ALS

F MÓDULOS MF

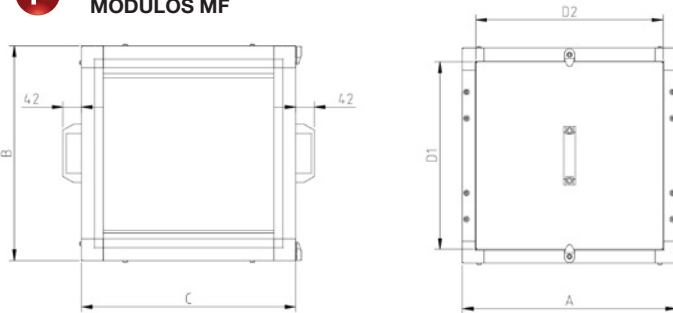

Modelo	A	B	C	D1	D2
MF-7/7	490	490	490	428	428
MF-9/9	550	550	550	488	488
MF-10/10	605	605	605	543	543
MF-12/12	680	680	680	618	618
MF-15/15	855	855	855	793	793

ME MÓDULOS ME

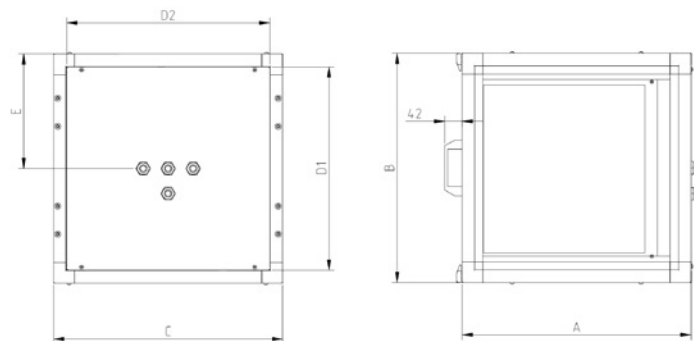

Modelo	A	B	C	D1	D2	E
ME-7/7	490	490	490	428	428	245
ME-9/9	550	550	550	488	488	275
ME-10/10	605	605	605	543	543	302,5
ME-12/12	680	680	680	618	618	340
ME-15/15	855	855	855	793	793	427,5

MA MÓDULOS MA

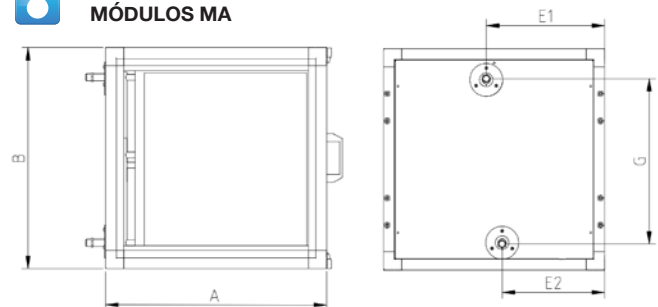

Modelo	A	B	C	D1	D2	E1	E2	G	H
MA-7/7	490	490	490	428	428	267	224	334	60
MA-9/9	550	550	550	488	488	297	254	410	57
MA-10/10	605	605	605	543	543	324	281	452	54
MA-12/12	680	680	680	618	618	362	319	527	79
MA-15/15	855	855	855	793	793	460	395	671	42

Curvas características ventiladores

7/7

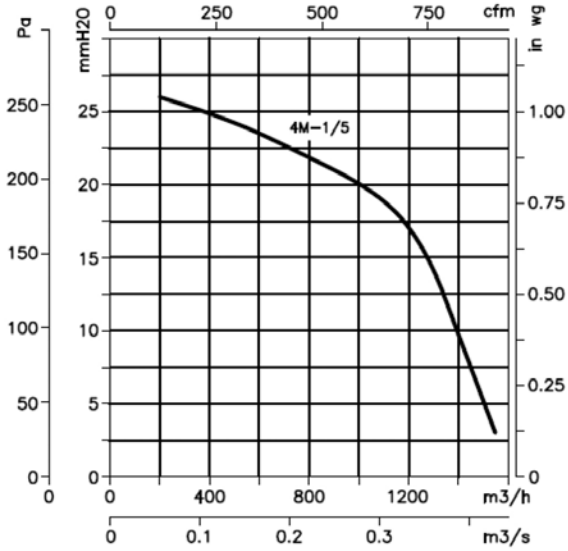

9/9

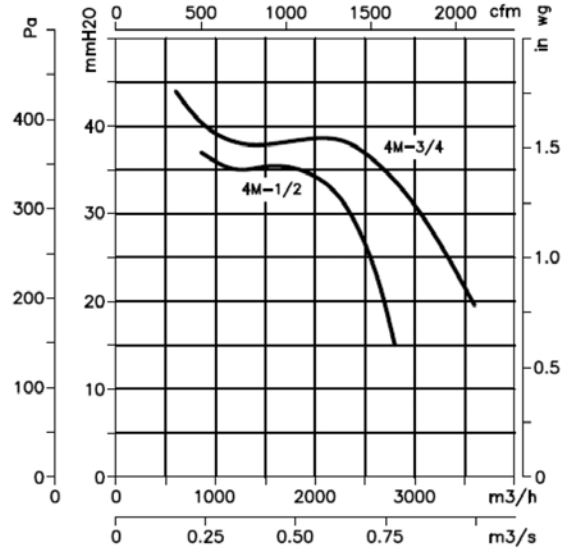

10/10

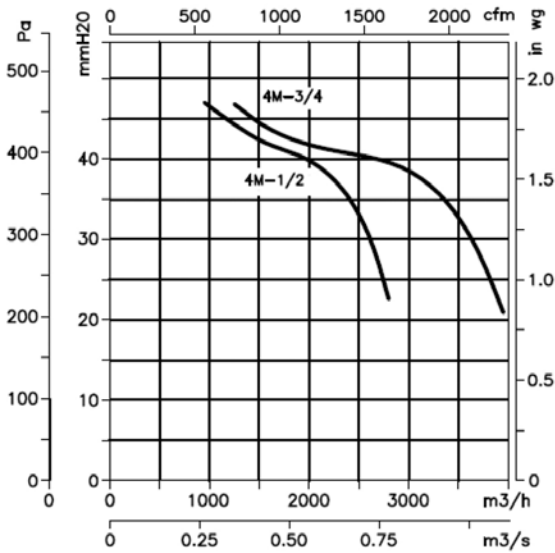

12/12 15/15

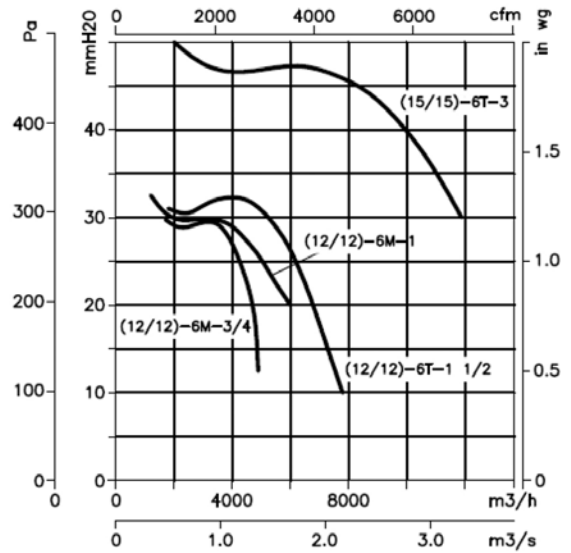

UDTX

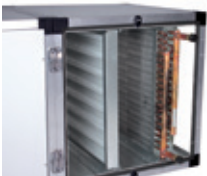

Unidades de ventilación con tratamiento de aire a transmisión, aisladas acústicamente, equipadas con ventiladores de doble aspiración y opciones de módulos de filtración, calefacción eléctrica o por agua

Caja:

- Estructura en perfilera de aluminio con aislamiento térmico y acústico.
- Panel de acceso lateral, para su correcto mantenimiento.
- Construcción modular, para añadir módulos de filtros o de tratamiento de aire.
- Prensaestopas para entrada de cable.

Ventilador:

- Unidades de ventilación equipadas con ventiladores de la serie CBX, CBXC o CBXR.
- Turbinas con álabes hacia adelante, en chapa de acero galvanizado.

Motor:

- Motores de eficiencia IE3 para potencias iguales o superiores a 0,75kW, excepto monofásicos, 2 velocidades y 8 polos.
- Motores clase F, con rodamientos a bolas, protección IP54.

- Motor Multitensión, diseño especial válido para: 220/380V 60Hz, 254/440V 60Hz, 265/460V 60Hz, 277/480V 60Hz
- Temperatura máxima del aire a transportar: -20°C.+ 60°C.

Versiones:

- MF: Módulo de filtración. Versión estándar F6+F8 y opcional F7+F9.
- ME: Módulo con batería eléctrica. Versión estándar G4 y opcional con filtros F6+F8 o F7+F9.
- MA: Módulo con batería de agua. Versión estándar G4 y opcional con filtros F6+F8 o F7+F9.

Bajo demanda:

- Impulsión vertical.
- Transmisión lado izquierdo.
- Módulo montado en impulsión.

Código de pedido

UDTX	—	15/15	—	2	—	MF	—	F6+F8	—	60Hz
↓		↓		↓		↓		↓		
Unidades de ventilación con tratamiento de aire		Tamaño turbina en pulgadas		Potencia motor (CV)		Módulos tratamiento de aire		Opciones de filtro para módulos MF		
						<ul style="list-style-type: none"> • MF: módulo de filtración (versión estándar) • ME: módulo con batería eléctrica (filtro G4 incluido) • MA: módulo con batería de agua (filtro G4 incluido) 		<ul style="list-style-type: none"> • Versión estándar F6+F8 • Opción: G4+F7, F7+F9 		

Características técnicas

60Hz

Modelo	Velocidad (r/min)	Intensidad máx admisible (A)		Potencia instalada (kW)	Caudal máximo (m3/h)	Nivel Sonoro dB(A)	Peso aprox (Kg)	Versión de montaje
		220-277V	380-480V					
UDTX-7/7-0,25	1090	1,23	0,71	0,18	1050	48	37	A
UDTX-7/7-0,33	1220	1,66	0,96	0,25	1100	50	37,8	A
UDTX-7/7-0,5	1420	2,02	1,17	0,37	1250	53	39	A
UDTX-7/7-0,75	1600	2,92	1,69	0,55	1450	56	41	A
UDTX-7/7-1	1790	3,1	1,79	0,75	1500	58	42,5	A
UDTX-9/9-0,25	825	1,23	0,71	0,18	1700	45	48	A
UDTX-9/9-0,33	920	1,66	0,96	0,25	1800	48	50	A
UDTX-9/9-0,5	1020	2,02	1,17	0,37	2200	51	51,5	A
UDTX-9/9-0,75	1050	2,92	1,69	0,55	2900	55	54,5	A
UDTX-9/9-1	1070	3,1	1,79	0,75	3200	56	56	A
UDTX-9/9-1,5	1260	4,03	2,32	1,1	3750	60	59	A
UDTX-10/10-0,5	845	2,02	1,17	0,37	2950	52	55	A

Características técnicas

Modelo	Velocidad (r/min)	Intensidad máx admisible (A)		Potencia instalada (kW)	Caudal máximo (m3/h)	Nivel Sonoro dB(A)	Peso aprox (Kg)	Versión de montaje
		220-277V	380-480V					
UDTX-10/10-0,75	845	2,92	1,69	0,55	3800	56	57	A
UDTX-10/10-1	960	3,1	1,79	0,75	4175	58	58,5	A
UDTX-10/10-1,5	1070	4,03	2,32	1,1	4800	61	61,3	A
UDTX-10/10-2	1140	5,96	3,44	1,5	5400	63	64,6	A
UDTX-12/12-0,5	595	2,02	1,17	0,37	4200	52	69	A
UDTX-12/12-0,75	675	2,92	1,69	0,55	4800	54	71	A
UDTX-12/12-1	765	3,1	1,79	0,75	5400	57	72,4	A
UDTX-12/12-1,5	855	4,03	2,32	1,1	5800	59	75,3	A
UDTX-12/12-2	965	5,96	3,44	1,5	6500	62	78,6	A
UDTX-12/12-3	1180	8,36	4,83	2,2	7400	65	87	A
UDTX-15/15-0,75	525	2,92	1,69	0,55	5900	49	85	B
UDTX-15/15-1	595	3,1	1,79	0,75	6500	52	86,4	B
UDTX-15/15-1,5	635	4,03	2,32	1,1	7500	54	89,3	B
UDTX-15/15-2	670	5,96	3,44	1,5	8200	56	92,6	B
UDTX-15/15-3	740	8,36	4,83	2,2	9500	59	101	B
UDTX-15/15-4	805	10,96	6,33	3	10600	61	103	B
UDTX-15/15-5,5	965	14,1	8,12	4	12000	63	108	B
UDTX-18/18-1,5	480	4,03	2,32	1,1	9000	48	122	B
UDTX-18/18-2	605	5,96	3,44	1,5	9250	51	125,3	B
UDTX-18/18-3	590	8,36	4,83	2,2	11500	54	133,7	B
UDTX-18/18-4	640	10,96	6,33	3	13200	56	135,7	B
UDTX-18/18-5,5	675	14,1	8,12	4	15000	58	141	B
UDTX-18/18-7,5	760		11,6	5,5	17000	60	154,5	B

Dimensiones mm

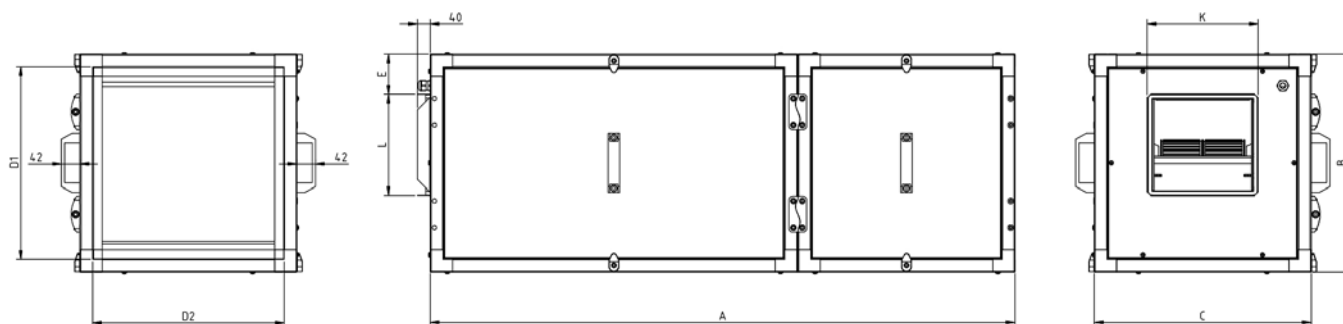

Modelo	A	B	C	D1	D2	E	L	K
UDTX-7/7	1321	490	490	428	428	91	226	247
UDTX-9/9	1411	550	550	488	488	86	279	317
UDTX-10/10	1461	605	605	543	543	88	306	343
UDTX-12/12	1541	680	680	618	618	84	360	404
UDTX-15/15	1711	855	855	793	793	119	423	490
UDTX-18/18	1847	1000	1000	938	938	137	498	554

Opciones módulos tratamiento de aire



MF: Módulos de filtración

- Estructura en perfilería de aluminio con aislamiento térmico y acústico.
- Panel de acceso lateral, para su correcto mantenimiento.
- Construcción modular, para añadir módulos de filtros o de tratamiento de aire.
- Módulo versión estándar F6+F8 y opcional F7+F9.
- Compatibles con las series UDT, UDTX, CJBD/ALG, CJBD/ALS, CJBX/ALG y CJBX/ALS.

ME: Módulos con batería eléctrica

- Estructura en perfilería de aluminio con aislamiento térmico y acústico.
- Panel de acceso lateral, para su correcto mantenimiento.
- Construcción modular, para añadir módulos de filtros o de tratamiento de aire.
- Prensaestopas para entrada de cable.
- Módulo versión estándar G4 y opcional con filtros F6+F8 o F7+F9.
- Compatibles con las series UDT, UDTX, CJBD/ALG, CJBD/ALS, CJBX/ALG y CJBX/ALS.

MA: Módulos con batería de agua

- Estructura en perfilería de aluminio con aislamiento térmico y acústico.
- Panel de acceso lateral, para su correcto mantenimiento.
- Construcción modular, para añadir módulos de filtros o de tratamiento de aire.
- Módulo versión estándar G4 y opcional con filtros F6+F8 o F7+F9.
- Compatibles con las series UDT, UDTX, CJBD/ALG, CJBD/ALS, CJBX/ALG y CJBX/ALS.

MF: Características módulo de filtración

F Pérdida de carga de filtros

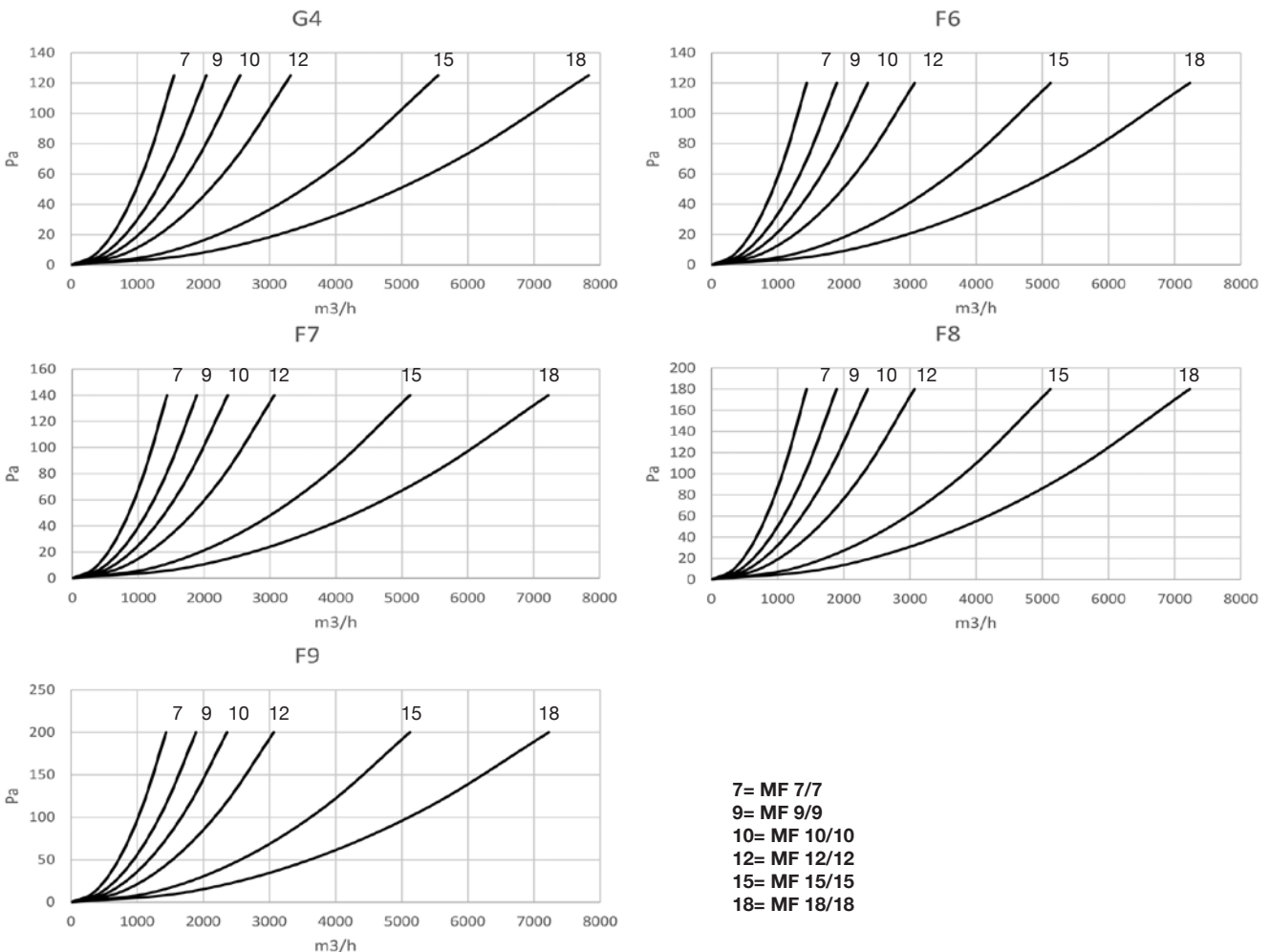

ME: Características módulos batería eléctrica



Modelo	Intensidad (A)	Potencia instalada (kW)			Caudal máximo (m3/h)	Peso aprox (Kg)
	400V	Etapa 1	Etapa 2	Etapa 3		
ME-7/7	13	3	3	3	1500	23
ME-9/9	23	5.4	5.4	5.4	3300	33
ME-10/10	33	7.7	7.7	7.7	4500	44
ME-12/12	52	12	12	12	6000	61
ME-15/15	81	18.8	18.8	18.8	10000	96
ME-18/18	97	22.5	22.5	22.5	13000	123

Pérdida de carga de baterías eléctricas

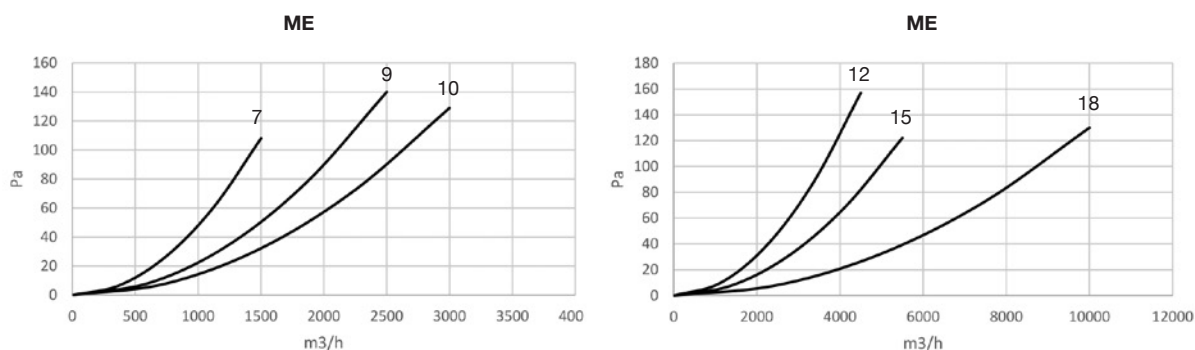

MA: Características módulos batería de agua 90/70°C con aire a 0°C



Modelo	Potencia	Caudal máximo	Caudal agua	Perdida carga agua	Conexión	Peso aprox.
	(kW)	(m3/h)	(m3/h)	(kPa)	(pulg)	(Kg)
MA-7/7	23	1500	1.0	16.3	1/2"	18
MA-9/9	37	2500	1.7	26.6	1/2"	25
MA-10/10	46	3000	2.0	17.6	3/4"	31
MA-12/12	66	4500	2.9	29.8	3/4"	39
MA-15/15	108	5500	4.8	21.4	1"	63
MA-18/18	153	10000	6.8	21.9	1 1/4"	87

MA: Características módulos batería de agua 80/60°C con aire a 0°C



Modelo	Potencia	Caudal máximo	Caudal agua	Perdida carga agua	Conexión	Peso aprox.
	(kW)	(m3/h)	(m3/h)	(kPa)	(pulg)	(Kg)
MA-7/7	20	1500	0.9	13.0	1/2"	18
MA-9/9	33	2500	1.4	21.3	1/2"	25
MA-10/10	40	3000	1.7	14.0	3/4"	31
MA-12/12	58	4500	2.5	23.8	3/4"	39
MA-15/15	100	5500	4.2	17.5	1"	63
MA-18/18	133	10000	5.8	17.5	1 1/4"	87

Pérdida de carga de baterías de agua

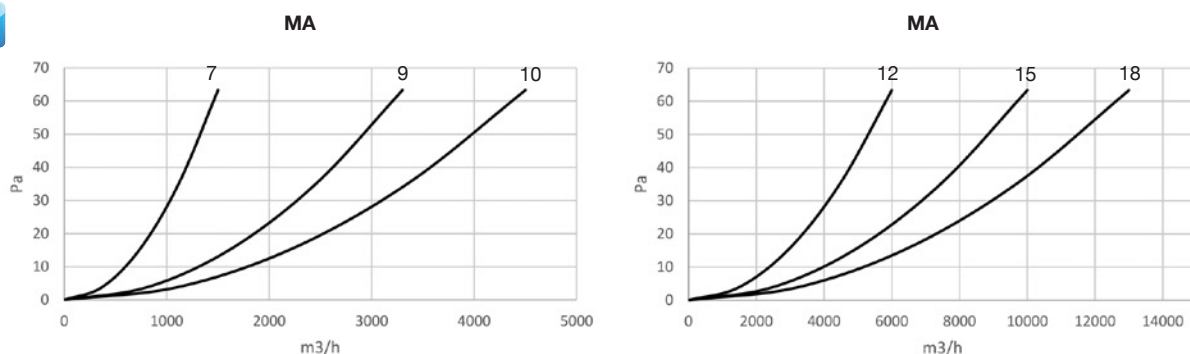

Esquemas de instalación y posición filtros

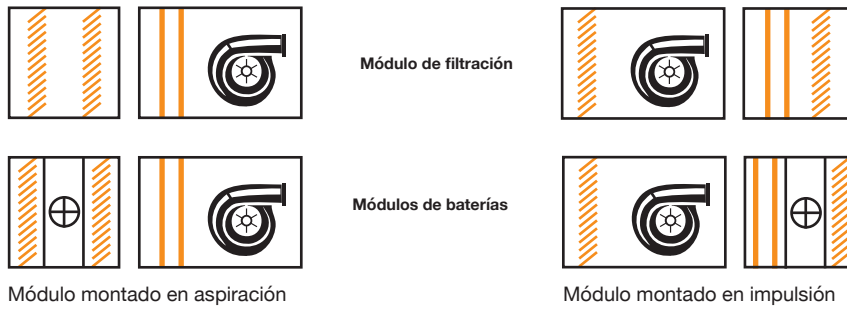

Dimensiones de los módulos mm

Compatibles con las series UDT, UDTX, CJBD/ALG, CJBD/ALS, CJBX/ALG y CJBX/ALS

F MÓDULOS MF

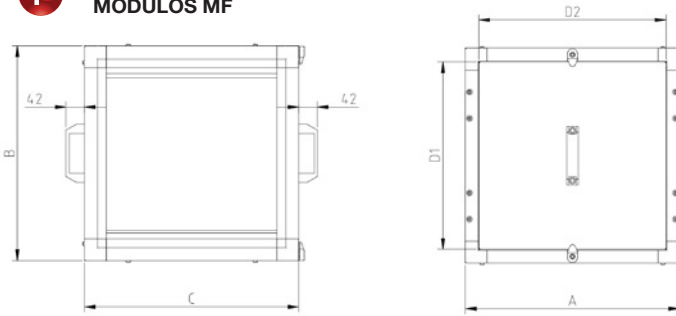

Modelo	A	B	C	D1	D2
MF-7/7	490	490	490	428	428
MF-9/9	550	550	550	488	488
MF-10/10	605	605	605	543	543
MF-12/12	680	680	680	618	618
MF-15/15	855	855	855	793	793
MF-18/18	1000	1000	1000	938	938

ME MÓDULOS ME

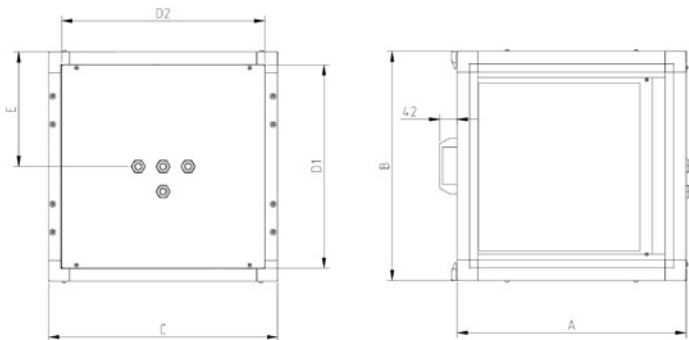

Modelo	A	B	C	D1	D2	E
ME-7/7	490	490	490	428	428	245
ME-9/9	550	550	550	488	488	275
ME-10/10	605	605	605	543	543	302,5
ME-12/12	680	680	680	618	618	340
ME-15/15	855	855	855	793	793	427,5
ME-18/18	1000	1000	1000	938	938	500

MA MÓDULOS MA

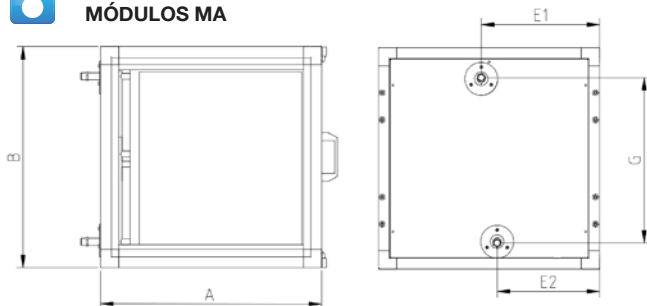

Modelo	A	B	C	D1	D2	E1	E2	G	H
MA-7/7	490	490	490	428	428	267	224	334	60
MA-9/9	550	550	550	488	488	297	254	410	57
MA-10/10	605	605	605	543	543	324	281	452	54
MA-12/12	680	680	680	618	618	362	319	527	79
MA-15/15	855	855	855	793	793	460	395	671	42
MA-18/18	1000	1000	1000	938	938	522	479	814	47

Curvas características ventiladores

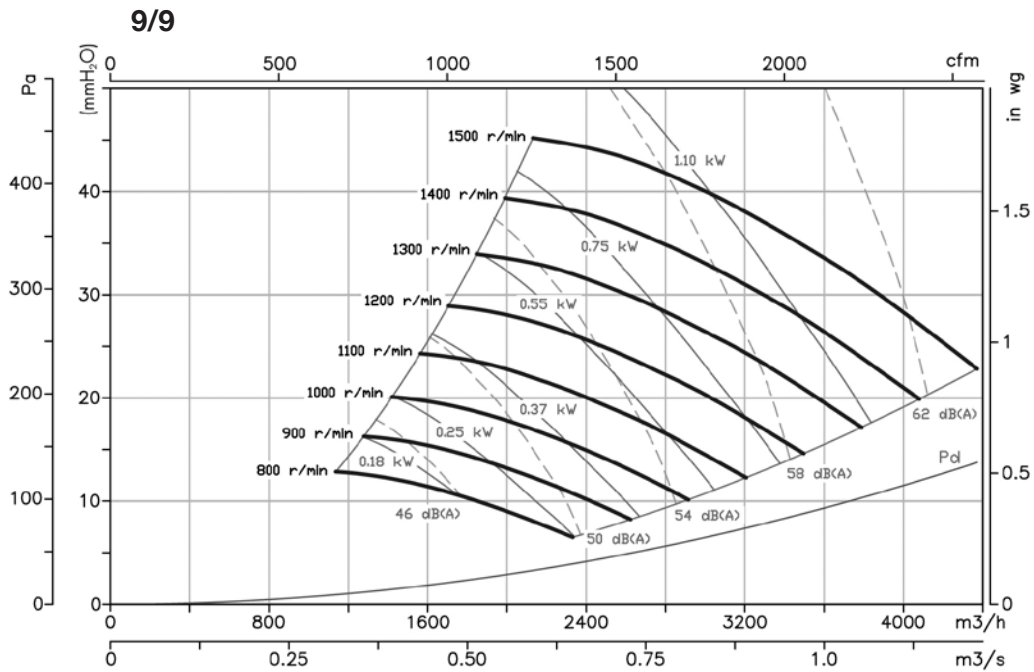
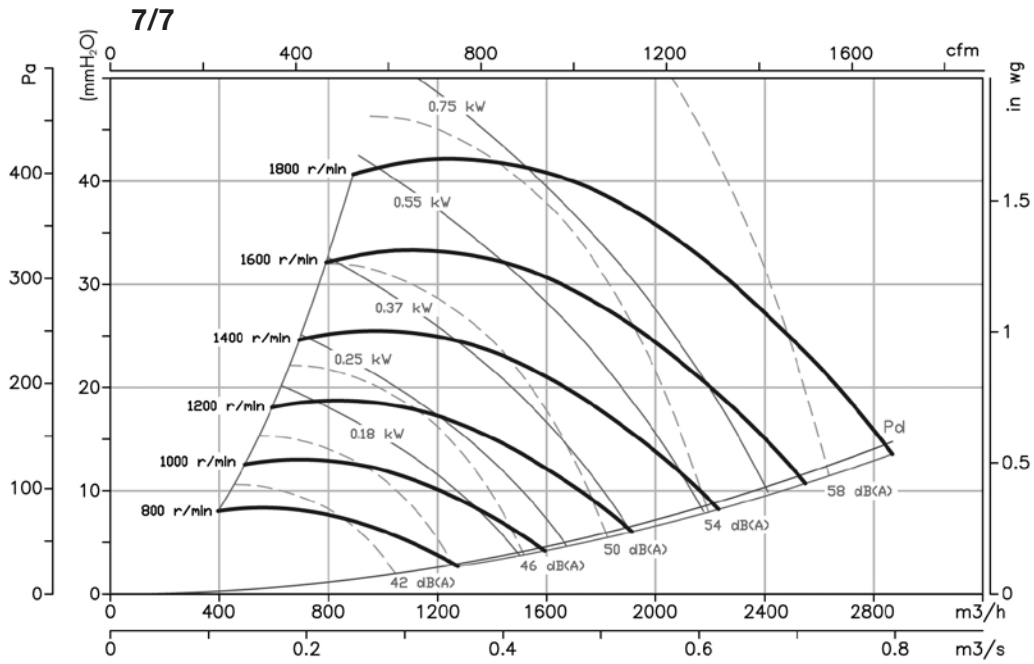

Curvas características ventiladores

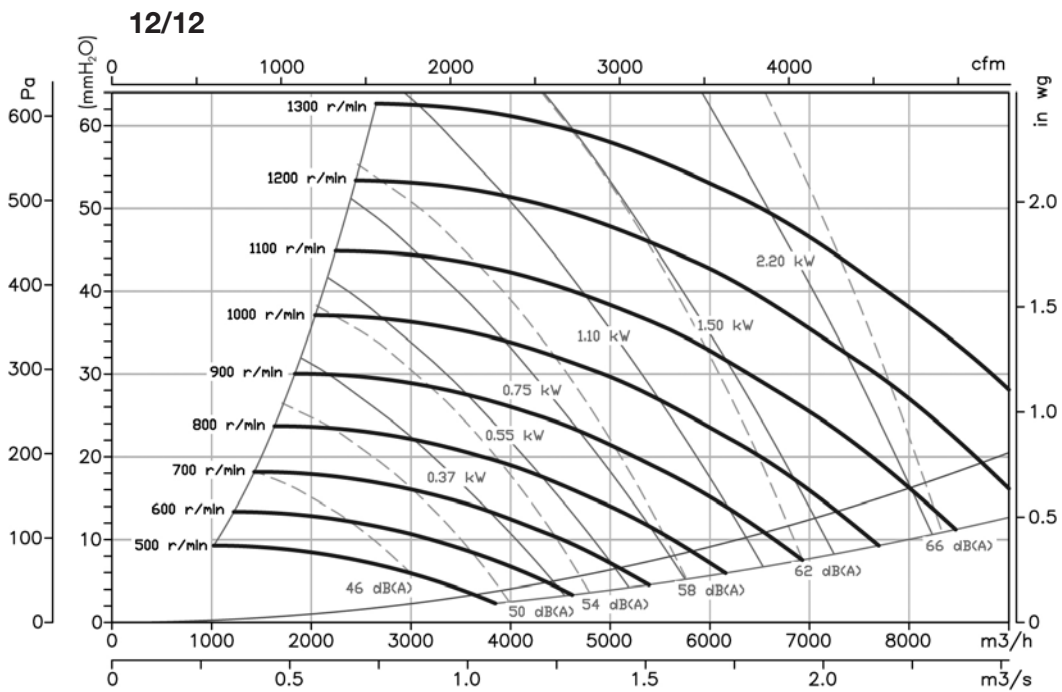
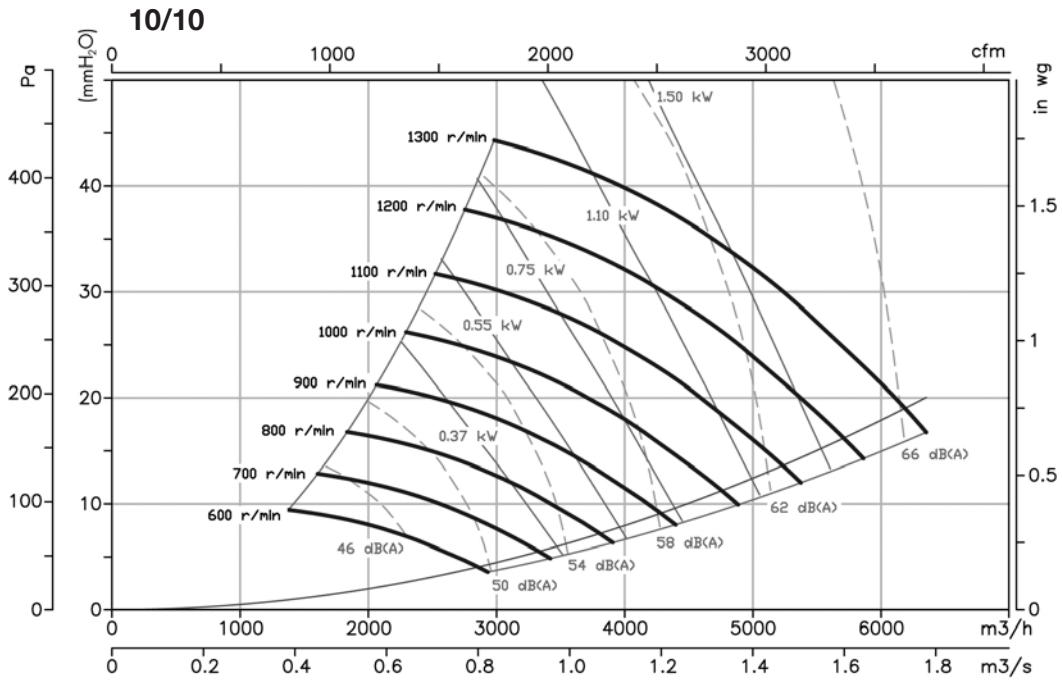

Curvas características ventiladores

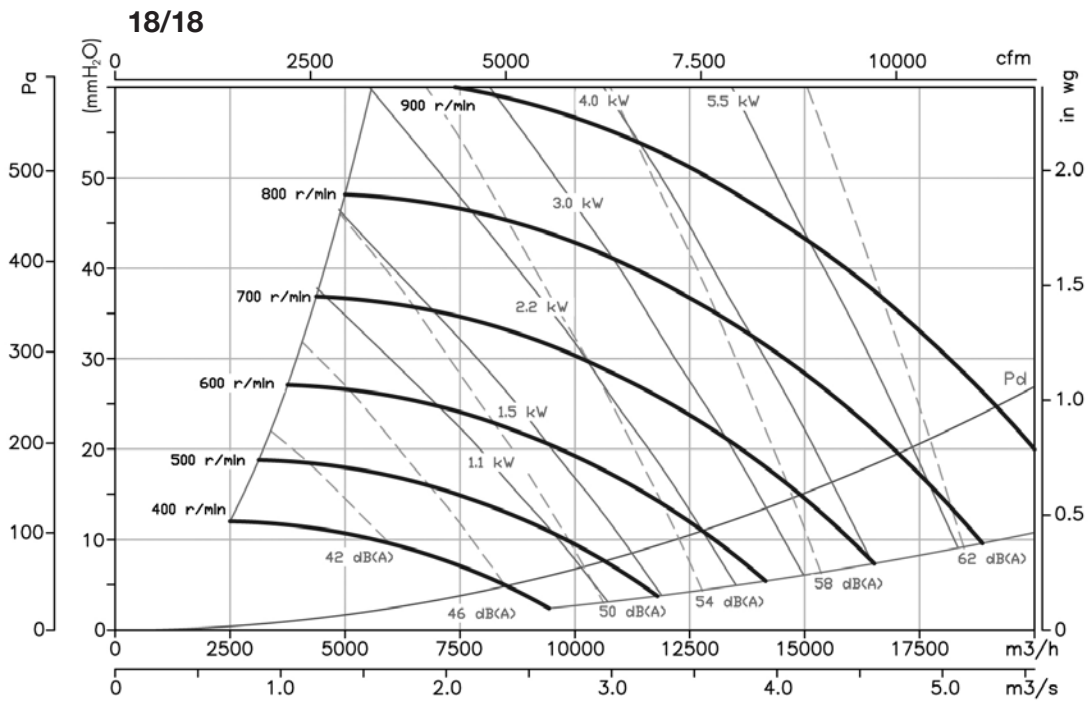
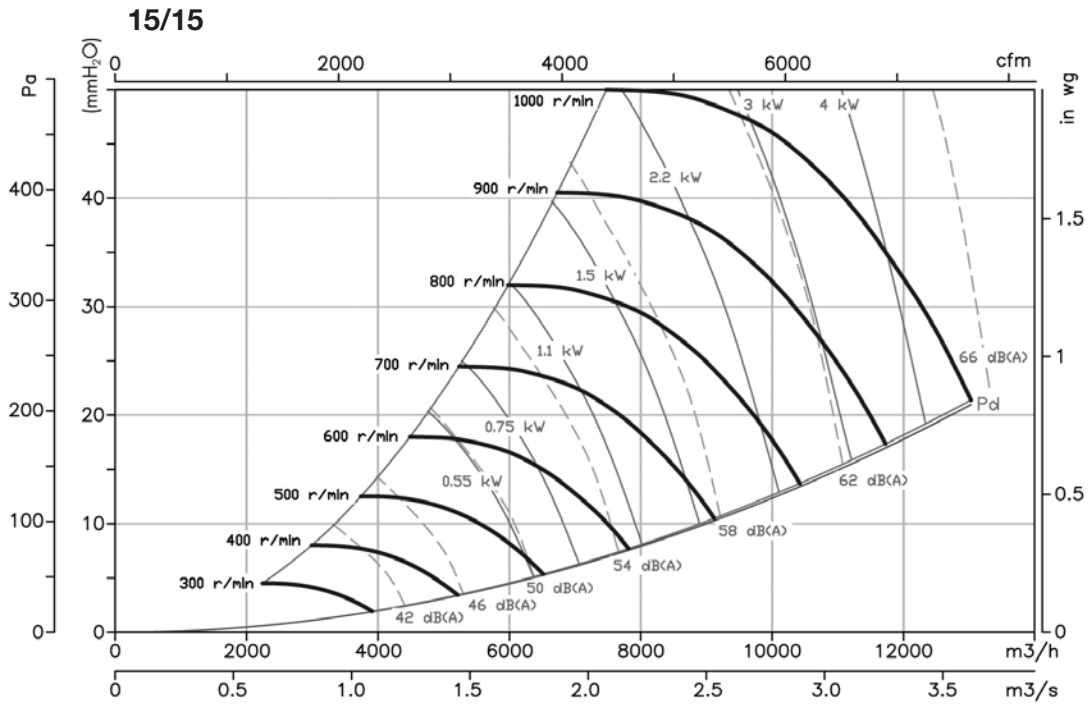



CORTINAS DE AIRE COMERCIALES E INDUSTRIALES

EFICIENCIA SIN COMPROMISOS

Las cortinas de aire consiguen reducciones del consumo en climatización de un local de hasta un 30%, evitando corrientes de aire y gradientes térmicos, que además afectan al confort y al bienestar.

DISEÑO INNOVADOR

Cortinas con una perfecta combinación entre la innovación y el diseño.



MÚLTIPLES APLICACIONES

Gran variedad de cortinas para múltiples aplicaciones, dimensiones de puertas y posibilidades de montaje.



AMPLIAS POSIBILIDADES DE CONTROL

La mayoría de cortinas disponen de varias opciones de control, para cubrir necesidades diversas.



DISEÑOS EFICIENTES

Diseños eficientes que consiguen flujos laminares orientables de mayor alcance y eficacia con el mínimo consumo eléctrico.

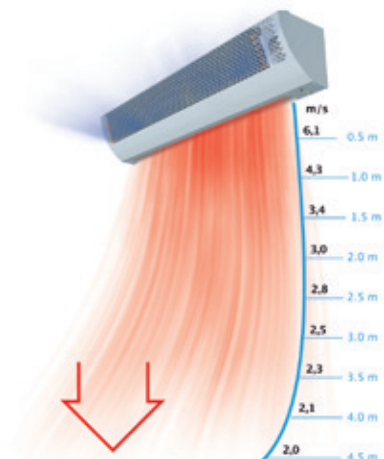

TIPOS DE CORTINAS DE AIRE

Las cortinas de aire pueden ser utilizadas recirculando simplemente el aire interior, o pueden utilizarse como calefacción en muchos locales:



AMBIENTALES

Recirculan mediante ventiladores, el aire ambiental, sin aportación de calor.



ELÉCTRICAS

Recirculan el aire ambiental, y cuando es necesario en los meses fríos, calienta el aire mediante resistencias eléctricas.



POR AGUA CALIENTE

Recirculan el aire ambiental, y cuando es necesario en los meses fríos, calienta el aire mediante baterías de agua caliente.

Las cortinas con calefacción eléctrica o con batería de agua, pueden ser utilizadas como elemento de calefacción, ya que su rendimiento y volumen de aire caliente, puede calentar una superficie de 500 a 750 m², según modelo, en el entorno de la puerta.

SELECCIÓN E INSTALACIÓN DE CORTINAS DE AIRE

- 1 Defina la serie de cortinas de aire de su interés , en función de la altura de la puerta y el diseño que usted prefiera
- 2 Elija el modelo idóneo según la longitud de la puerta, la cortina debe cubrir el hueco de la puerta, sobresaliendo 100mm por lado
- 3 Seleccione el tipo de cortina deseada, ambiental, eléctrica o por agua caliente
- 4 Seleccione una cortina de aire lo más ajustada a sus necesidades, para obtener el nivel sonoro adecuado
- 5 Instale la cortina lo más cerca posible de la entrada, en lado interior del local
- 6 En caso de separación de locales con gran refrigeración, instale la cortina en el lado más caluroso

Para obtener un óptimo funcionamiento, es aconsejable instalar y controlar la cortina de aire mediante los controladores especialmente diseñados para esta aplicación.

ECONOMIC

Cortinas de aire económicas, para pequeños recintos comerciales

Cortinas de aire económicas para alturas hasta 3m, para instalación horizontal, especialmente diseñadas para pequeños recintos comerciales



Control

Construcción:

- Estructura metálica pintada
- Diseño para instalación horizontal
- Versión S: Dos velocidades de funcionamiento del ventilador
- Led indicador de funcionamiento
- Soportes para montaje en pared
- Versión E: Control de batería eléctrica con elementos de seguridad. Paro del ventilador retardado para evacuar calor residual

Versión:

- Ambiental: Recirculación de aire
- Eléctrica: Incorpora resistencias eléctricas

Control externo

- Versión E: Control con mando a distancia

Aplicaciones: Pequeños locales	comerciales Tiendas	Bares Oficinas
--	------------------------	-------------------

Control:		
Funcionamiento	manual	manual
Velocidades	2 velocidades	1 velocidad
Control batería eléctrica	no	1 nivel de potencia
Contacto para puerta	no	no
Led indicador funcionamiento	si	si

Código de pedido

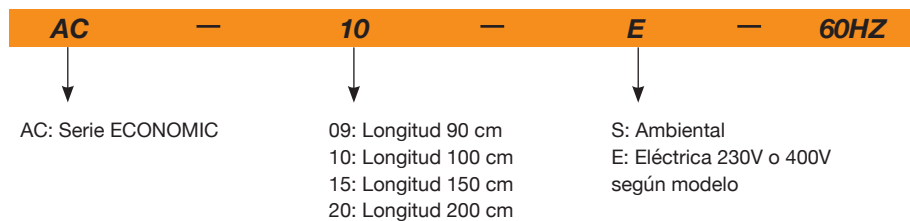

Características técnicas

Modelo	Puerta altura (m)	Caudal máximo (m³/h)	NPS irradiado dB(A)	Potencia calorífica (kW)	Tensión batería (V)	Intensidad batería (A)	Tensión ventilador (V)	Intensidad ventilador (A)	Peso (Kg)
AC-09-S	3	1440	45,15				1x220	0,65	14,5
AC-10-S	3	1620	46,20				1x220	0,72	16
AC-15-S	3	2520	48,30				1x220	0,95	23,5
AC-09-E	3	1200	47,25	3,5	1x230	15	1x220	0,65	18
AC-10-E	3	1380	48,30	4,0	1x230	19	1x220	0,72	20
AC-15-E	3	2160	49,35	5,5	3X400	9	1x220	0,95	31
AC-20-E	3	2880	53,55	10	3X400	16	1x220	1,38	39

Dimensiones mm

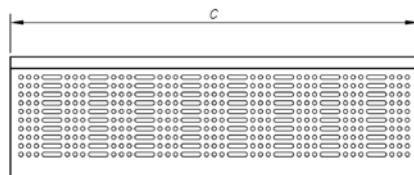
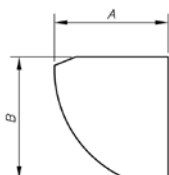

Modelo	A	B	C
AC-09-S	200	215	900
AC-10-S	200	215	1000
AC-15-S	200	215	1500
AC-09-E	195	220	900
AC-10-E	195	220	1000
AC-15-E	195	220	1500
AC-20-E	195	220	2000

Índice Alfabético de Referencias. VENTILADORES

CA	196	CJTHT	325	HC	27	KIT BOXPDS	385
CAS	199	CJTSA	165	HCD	35	KIT SOBREPRESIÓN	381
CAS-S	199	CJTX-C	351	HCDF	397	NEOLINEO/V	19
CBD	120	CMA	188	HCH	37	NEOSILENT	21
CBX	126	CMA/ATEX	404	HCH/ATEX	400	RECUP	419
CBXC	126	CMP	175	HCT	37	RFH	222
CBXR	126	CMP/ATEX	406	HCT/ATEX	400	RFV	222
CBXT	126	CMR	183	HCT/IMP	54	SV/FILTER	423
CDXR	144	CMR/ATEX	410	HCT/IMP-C	52	SVE	13
CDXRT	144	CMX	111	HDF	397	SVE/PLUS	13
CI	335	CPV	191	HFV	57	TCR/R	346
CI-CO	110	CRF	227	HGI	33	THT	272
CJBD/ALG	123	CSX	365	HGT	75	THT/IMP	331
CJBX/ALG	136	CSXR	153	HGTX	75	THT/ROOF	343
CJBR	169	CSXRT	153	HPX	102	TSA	165
CJDXR	144	CXT	217	HT	230	TSAT	165
CJHCH	49	ECONOMIC	447	HTMF	336	UDT	431
CJSX	359	EDMF	24	HTMH	233	UDTX	437
CJSXR	153	HATCH PDS	387	HTMV	240	UFR	427
CJTCR/R	346	HBA	105	HTP	62	VC-HDU	208

EFFICIENT WORK FANS



SOLution DEvelopment CAPacity

Fast and flexible industrial fan solutions and tailored fans

Large experience in smoke control systems and ATEX applications

Wide range of certified products for specific markets

VENTILADORES
HELICOIDALES Y
EXTRACTORES DE TEJADO



VENTILADORES
CENTRÍFUGOS Y EXTRACTORES
EN LÍNEA



EXTRACTORES
PARA EVACUACIÓN
DE HUMOS



VENTILADORES HEAVY DUTY
Y EXTRACTORES PARA
ATMÓSFERAS EXPLOSIVAS ATEX



RECUPERADORES DE CALOR,
UNIDADES DE FILTRACIÓN
Y TRATAMIENTO DE AIRE



CORTINAS DE AIRE PARA
APLICACIONES COMERCIALES E
INDUSTRIALES



SISTEMAS DE VENTILACIÓN
PARA VIVIENDAS



SOLICÍTENOS
INFORMACIÓN



www.sodeca.com



HEADQUARTER

Sodeca, S.L.U.
Pol. Ind. La Barricona
Carrer del Metall, 2
E-17500 Ripoll
Girona, SPAIN
Tel. +34 93 852 91 11
Fax: +34 93 852 90 42
General sales:
comercial@sodeca.com
Export sales:
ventilation@sodeca.com

PRODUCTION PLANT

Sodeca, S.L.U.
Ctra. de Berga, km 0,7
E-08580 Sant Quirze de
Besora
Barcelona, SPAIN
Tel. +34 93 852 91 11
Fax: +34 93 852 90 42
General sales:
comercial@sodeca.com
Export sales:
ventilation@sodeca.com

RED COMERCIAL ESPAÑA

Barcelona
Sr. Jesús Cuadras
Pol. Ind. La Barricona
Carrer del Metall, 2
E-17500 Ripoll
Girona, SPAIN
Tel. +34 93 852 91 11
Móvil: 639 077 346
jcuadras@sodeca.com
Provincias: Barcelona,
Tarragona, Lleida y Girona

Baleares
Sr. Miquel Àngel Morán
Móvil: 682 912 100
baleares@sodeca.com
Provincias: Baleares

Bilbao
Pitalven S.L.
Sr. Jon Garin
Pza. Jaro de Arana, 3 4º
48012 Bilbao
Tel./Fax 94 421 42 23
Móvil: 615 749 646
jgarin@sodeca.com
Provincias: Vizcaya,
Guipúzcoa, Álava,
Santander, Navarra y Rioja

Canarias
Srta. Ana Terrones
Móvil: 676 340 543
canarias@sodeca.com
Provincias: Islas Canarias

A Coruña
Sr. Ricard Fernández
Rúa a Granxa, 2B (Lorbe)
15177 Oleiros
Tel./Fax 98 162 81 96
Móvil: 615 145 104
rfernandez@sodeca.com
Provincias: A Coruña,
Lugo, Ourense y
Pontevedra

Oviedo
Sr. Salvador Nuñez
Tel. 93 852 91 11
Móvil: 689 804 734
asturias@sodeca.com
Provincias: Asturias y León

Madrid
Sr. José María de Bernardo
Pol.Ind. Miralcampo
Calle Aluminio, 12
19200 Azuqueca de
Henares
Tel. 91 366 70 45 /
91 366 60 45
Móvil: 670 744 420
sodecacentro@sodeca.com
Provincias: Madrid, Toledo,
Ciudad Real, Guadalajara,
Segovia, Ávila y Cuenca

Murcia
Sr. Francisco José Hurtado
Apartado de Correos 6103
30080 Murcia
Tel. 675 767 025
hurtado@sodeca.com
Provincias: Murcia,
Almería, Granada y Jaén

Sevilla
Sr. Manuel Zambrano
Pol.Ind. Los Llanos
Calle Extremadura, 169 F
41909 Salteras
Sevilla
Móvil: 606 663 814
mzambrano@sodeca.com
sevilla@sodeca.com
Provincias: Sevilla, Huelva,
Cádiz, Córdoba, Málaga,
Cáceres y Badajoz

Valencia
Tacier S.L.
Sr. Javier Talens
Timoneda, 8, 1º
46008 Valencia
Tel. 96 384 14 80
Fax 96 382 02 07
Móvil: 670 696 289
javiertalens@sodeca.com
csebastian@sodeca.com
Provincias: Valencia,
Castellón, Alicante y
Albacete

Valladolid
Sr. Xavier Formentí
Tel. 93 852 91 11
Móvil: 679 559 099
sodecacastilla@sodeca.com
Provincias: Salamanca,
Valladolid, Palencia,
Burgos y Zamora

Zaragoza
Hernández Silbe S.L.
Srta. Silvia Hernández
Alfonso I, casa 15
50410 Cuarte de Huerva
Zaragoza
Tel. 630 263 224
Fax 97 693 74 30
sodecaragon@sodeca.com
Provincias: Huesca,
Zaragoza, Teruel y Soria



EUROPE

FINLAND
Sodeca Finland, Oy
HUITTINEN
Sales and Warehouse
Mr. Kai Yli-Sipilä
Metsälinnankatu 26
FI-32700 Huittinen
Tel. + 358 400 320 125
orders.finland@sodeca.com

HELSINKI
Smoke Control Solutions
Mr. Antti Kontkanen
Viipullantie 9C
FI-00700 Helsinki
Tel. +358 400 237 434
akontkanen@sodeca.com
Mrs. Kaisa Partanen
Tel. +358 451 308 038
kpartanen@sodeca.com

HYVINKÄÄ
Smoke extraction and industrial
applications
Niinistökatu 12
FI-05800 Hyvinkää
Mr. Jaakko Tomperi
Tel. +358 451 651 333
jtomperi@sodeca.com
Mr. Jarno Pikkumäki
Tel. +358 407 723 472
jpikkumaki@sodeca.com

ITALIA
Marelli Ventilazione, S.R.L.
Viale del Lavoro, 28
37036 San Martino B.A.
(VR), ITALY
Tel. +39 045 87 80 140
vendite@sodeca.com

PORTUGAL
Sodeca Portugal, Unip. Lda.
PORTO
Rua Veloso Salgado 1120/1138
4450-801 Leça de Palmeira
Tel. +351 229 991 100
geral@sodeca.pt

LISBOA
Pq. Emp. da Granja Pav. 29
2625-607 Vialonga
Tel. +351 219 748 491
geral@sodeca.pt

ALGARVE
Rua da Alegria, 33
8200-569 Ferreiras
Tel. +351 289 092 586
geral@sodeca.pt

UNITED KINGDOM
Sodeca Fans UK, Ltd.
Mr. Mark Newcombe
Tamworth Enterprise Centre
Philip Dix House, Corporation
Street, Tamworth, B79 7DN
UNITED KINGDOM
Tel. +44 (0) 1827 216 109
sales@sodeca.co.uk

AMERICA

CHILE
Sodeca Ventiladores, SpA.
Sra. Sofía Ormazábal
Santa Bernardita 12.005
(Esquina con Puerta Sur)
Bodegas 24 a 26,
San Bernardo, Santiago, CHILE
Tel. +56 22 840 5582
ventas.chile@sodeca.com

COLOMBIA
Sodeca Latam, S.A.S.
Sra. Luisa Stella Prieto
Calle7 No. 13 A-44
Manzana 4 Lote1, Montaña
Mosquera, Cundinamarca
Bogotá, COLOMBIA
Tel. +57 1 756 4213
ventascolumbia@sodeca.co

PERU
Sodeca Perú, S.A.C.
Sr. Jose Luis Jiménez
C/ Mariscal Jose Luis de
Orbegoso 331. Urb. El pino.
15022, San Luis. Lima, PERU
Tel. +51 1 326 24 24
Cel. +51 994671594
comercial@sodeca.pe



HEADQUARTER

Sodeca, S.L.U.
 Pol. Ind. La Barricona
 Carrer del Metall, 2
 E-17500 Ripoll
 Girona, SPAIN
 Tel. +34 93 852 91 11
 Fax: +34 93 852 90 42
 General sales: comercial@sodeca.com
 Export sales: ventilation@sodeca.com

PRODUCTION PLANT

Sodeca, S.L.U.
 Ctra. de Berga, km 0,7
 E-08580 Sant Quirze de Besora
 Barcelona, SPAIN
 Tel. +34 93 852 91 11
 Fax: +34 93 852 90 42
 General sales: comercial@sodeca.com
 Export sales: ventilation@sodeca.com



www.sodeca.com

